

**STOCK MARKET PERFORMANCE BEFORE AND  
AFTER THE PROMULGATION OF THE NEW  
CONSTITUTION (2010) AT THE NAIROBI SECURITIES  
EXCHANGE.**

**KAMAU JOHNSON**

**D61/61341/2010**

**SUPERVISOR**

**MR. JAMES M. NG'ANG'A**

**A MANAGEMENT RESEARCH PROJECT SUBMITTED IN PARTIAL  
FULFILMENT OF THE REQUIREMENT FOR THE AWARD OF  
MASTER OF BUSINESS ADMINISTRATION (MBA) DEGREE, SCHOOL  
OF BUSINESS, UNIVERSITY OF NAIROBI.**

**AUGUST, 2012**

## DECLARATION

This management research project is my original work and has not been presented for the award of any degree in any other University and where other peoples research work has been used, they have been duly acknowledged.

**KAMAU JOHNSON**

**REG. NO. D61/61341/2010**



**SIGNATURE**

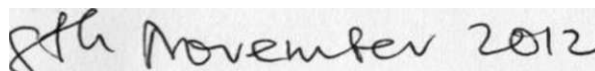

**DATE**

This management research project has been submitted for examination with my approval as the University supervisor.

**MR JAMES M. NG'ANG'A**

**Lecturer, Department of Accounting and Finance**

**School of Business**

**University of Nairobi**



**SIGNATURE**

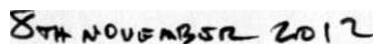

**DATE**

## **ACKNOWLEDGEMENTS**

This research could not have been a success without the assistance and support of various people.

Many thanks to the Almighty God for seeing me through the entire study period; who inspired, guided and instructed me in every step of the way.

Sincere thanks to my supervisor Mr. James M. Ng'ang'a who was always available to review and correct my work. My special thanks to my dear wife. Rose for moral support, understanding and encouragement during the study period.

Am also thankful to the MBA Coordinator Dr. X.N. Iraki for his guidance and mentorship that has helped me complete this program.

I also thank my MBA colleagues especially Albanus Mumo and Sarah Wanjiru, my friends and family members for their support and always being available throughout my study.

## **DEDICATION**

To my lovely wife Rose, my dear grandmother Naomi and mum Elizabeth.

In loving memory of my dear uncle, mentor and hero, the Late Stephen Wagereka Mbugua.

## **ABSTRACT**

This study was carried out to investigate the stock market performance before and after the promulgation of the new constitution (2010) at the Nairobi Securities Exchange. The study focused on the NSE performance 6 months before and 6 months after the promulgation of the new constitution. The NASI indices for the period February 2010 to February 2011 were obtained from the NSE and analyzed using line graphs. All the 10 market segments were considered whereas out of the total 58 stocks only 35 stocks passed the selection criteria and as such considered in this study. This study employed the market model to estimate the quoted firms' returns on their shares while regression analysis was used to analyze stocks returns against the market returns.

The performance of the stock market is influenced by a number of factors namely Demand and Supply of shares in the market. News related to a firm. Market capitalization of the company, Earnings report and dividend announcement. Inflation and Interest rates and political factors. This study concentrated more on political factors and held other factors constant. Various studies have been carried out in America and Britain examining the performance of stock markets in these countries before and after general elections. These studies indicate that the stock market react differently based on the party of the President elected in America while there was no difference in Britain.

This study revealed that the stock market recorded higher returns before the promulgation and average returns during the event date. However the performance after the promulgation was poor thus the market performance was indifferent.

Various recommendations for further study and some of the limitations to the study were identified and noted in chapter 5. Some limitations included unavailability of daily data on some stocks and limited time for the study.

## TABLE OF CONTENTS

<b>DECLARATION.....</b>	<b>ii</b>
<b>ACKNOWLEDGEMENTS.....</b>	<b>iii</b>
<b>DEDICATION.....</b>	<b>iv</b>
<b>ABSTRACT.....</b>	<b>v</b>
<b>TABLE OF CONTENTS.....</b>	<b>vii</b>
<b>LIST OF FIGURES.....</b>	<b>x</b>
<b>ABBREVIATION.....</b>	<b>xi</b>
<b>CHAPTER ONE.....</b>	<b>1</b>
1.0    INTRODUCTION.....	1
1.1    Background of the study.....	1
1.2    Nairobi Securities Exchange.....	3
1.3    Statement of the problem.....	4
1.4    Objective of the study.....	6
1.5    Significance of the study.....	7
<b>CHAPTER TWO.....</b>	<b>8</b>
2.0    LITERATURE REVIEW.....	8
2.1    Stock Market Performance.....	8
2.2    Review of theories.....	10
2.2.1    Efficient Market Hypothesis (EMH).....	10
2.2.2    Random Walk Theory.....	11
2.2.3    Political Business Cycle Theory.....	12
2.3    Factors affecting stock prices in the market.....	13
2.3.1    Demand and Supply of shares in the market.....	13
2.3.2    Impact of news related to a company.....	13
2.3.3    Market Capitalization of the company.....	14
2.3.4    Earnings report and Dividends announcement.....	15
2.3.5    Inflation and Interest rates.....	16

2.3.6	Political factors.....	16
2.4	Studies on political events and stock returns and their findings.....	16
2.5	Event Studies.....	18
<b>CHAPTER THREE.....</b>		<b>21</b>
3.0	RESEARCH METHODOLOGY.....	21
3.1	Introduction.....	21
3.2	Research Design.....	21
3.3	Population.....	21
3.4	Data collection.....	21
3.5	Data Analysis.....	22
<b>CHAPTER FOUR.....</b>		<b>25</b>
4.0	DATA ANALYSIS AND RESULTS.....	25
4.1	Introduction.....	25
4.2	Hypothesis Test.....	26
4.3	Market performance by market segment.....	26
4.3.1	Market performance for Agricultural Segment.....	26
4.3.2	Market performance for Commercial and Services Segment.....	27
4.3.3	Market performance for Telecommunication and Technology Segment.....	28
4.3.4	Market performance for Automobiles and Accessories Segment.....	29
4.3.5	Market performance for Banking Segment.....	30
4.3.6	Market performance for Insurance Segment.....	31
4.3.7	Market performance for Investment Segment.....	32
4.3.8	Market performance for Manufacturing and Allied Segment.....	33
4.3.9	Market performance for Construction and Allied Segment.....	34
4.3.10	Market performance for Energy and Petroleum Segment.....	35
4.3.11	General performance for all Market Segments and NASI Index.....	36
4.4	Market performance using market beta.....	38
<b>CHAPTER FIVE.....</b>		<b>40</b>
5.0	SUMMARY, CONCLUSION AND RECOMMENDATIONS.....	40



5.1	<b>Introduction.....</b>	<b>40</b>
5.2	Summary of Findings and Conclusion.....	40
5.3	Limitations of the Study.....	41
5.4	Recommendations for further study.....	41
	<b>REFERENCES.....</b>	<b>43</b>
	<b>APPENDICES.....</b>	<b>49</b>
	APPENDIX I: Companies Listed on the NSE by market segment.....	49
	APPENDIX II: Companies that were sampled in this study.....	51
	APPENDIX III: STOCK PRICE MOVEMENT AND RETURNS.....	53
	APPENDIX IV: PRICE MOVEMENT AND RETURNS PER SEGMENT.....	56
	APPENDIX V: SUMMARY OF STOCK BETA BY SEGMENT.....	59

## LIST OF FIGURES

Figure 4. 1 Market performance for Agricultural segment.....	27
Figure 4. 2 Market performance for Commercial and Services segment.....	28
Figure 4. 3 Market performance for Telecommunication and Technology segment.....	29
Figure 4. 4 Market performance for Automobiles and Accessories segment.....	30
Figure 4. 5 Market performance for Banking segment.....	31
Figure 4. 6 Market performance for Insurance segment.....	32
Figure 4. 7 Market performance for Investment segment.....	33
Figure 4. 8 Market performance for manufacturing and Allied segment.....	34
Figure 4. 9 Market performance for Construction and Allied segment.....	35
Figure 4. 10 Market performance for Energy and Petroleum segment.....	36
Figure 4. 11 Market performance for all segments combined.....	38
Figure 4. 12 Market performance for all segments using market Beta.....	39

## **ABBREVIATION**

CKRC - Constitution of Kenya Review Commission

EMH - Efficient Market Hypothesis

GDP - Gross Domestic Product

NASI - NSE All Share Index

NCC - National Constitutional Conference

NSE - Nairobi Securities Exchange

TSE - Toronto Stock Exchange

# CHAPTER ONE

## 1.0 INTRODUCTION

This chapter focuses on explaining the statement of the problem as well as research questions, research objectives and the importance of the study.

### 1.1 Background of the study

Recent globalization with rapid global economy integration has caused individual stock market growth and compaction. The stock market is a national economy barometer in that it speculates on the future of the economy. Thus political information easily spreads into the stock market with consequent mass media development. It generally responds to new political information that may affect the national economy future. Hence, whether or not political change influences the stock market continues to be an important analysis for scholars and market participators (Chan and Wei, 1996; Bittlingmayer, 1998; Kim and Mei, 2001; Perotti and Oijen, 2001; Hassan *et al.*, 2003).

Exploring complicated relationship between stock market and political behaviour using statistical methods is one of most exciting issues for academicians and investors. Politics and that economy are inextricably linked; that is. they have significant influence on each other, and cannot be separated (Harms. 2002; Chiu *et al.*, 2005).

Stock markets in the world represent an ownership interest in a corporation, entitling its owners a right to vote in the board of directors and grants the holders a residual claim in the firm's cash flow. Common stock is a popular form of investing used by individual investors and gives them the opportunity to tailor their investment programs to meet individual needs

and preferences. The market performance is measured in two forms. The main form is the periodic payment which is also referred to as dividends while the other form is the appreciation in the stock value i.e. the gain from selling the stock for more than the original purchase price. This is also referred to as capital income (Reilly & Brown. 2003).

Stock returns are crucial to investors. They not only take into account price behavior but also dividend income. They can be used to assess the performance of stocks. Various pricing model can be used to determine stock returns. The models too can be used to assess the impact of the different factors influencing stock returns.

The performance of stock market is influenced by a number of factors key among them the activities of governments and the general performance of the economy. Monetary and fiscal measures enacted by government agencies influences the aggregate economies of a given country. The resulting economic conditions influence all industries and companies within the economies either positively or negatively. These in turn affect the performance of stock markets. It is these factors that determine the level of risk on a given investment.

Past studies done in other parts of the world have clearly indicated that political events have an effect on the performance of the financial markets, (Becmann and Bolliger, 2001). The emerging literature suggests that major political events such as General elections have significant explanatory power in emerging market performance. It has been noted that political variables are correlated with value of currencies in a country. In such a case countries with weak governments are more vulnerable, while the ones with strong governments tend to be least vulnerable (Block 2001, Drazen 1999).

Various studies have been done to examine the immediate market reaction to a major political factor such as general election. Studies using various event methodologies have provided consistent evidence that the immediate market reaction to the election of a Republican president is positive while the election of a Democratic president creates a negative market reaction (Siegel, 1998 and Riley, 1980). The party effect, in which popular wisdom asserts that the stock market prefers Republican President to Democratic President, turns out to be false. In deed the evidence supports the opposite proposition in that stocks performs better under Democratic presidents than under Republicans (Jones, 2002).

## **1.2 Nairobi Securities Exchange**

The **Nairobi Securities Exchange (formerly Nairobi Stock Exchange) (NSE)** is the principal stock exchange of Kenya. It began in 1954 as an overseas stock exchange while Kenya was still a British colony with permission of the London Stock Exchange. The NSE is a member of the African Stock Exchanges Association. It is Africa's fourth largest stock exchange in terms of trading volumes, and fifth in terms of market capitalization as a percentage of GDP. The Exchange works in cooperation with the Uganda Securities Exchange and the Dar es Salaam Stock Exchange, including the cross listing of various equities.

The NSE's offices and trading floor are located at the Nation Centre along Kimathi Street in Nairobi, Kenya. Trading is done through the Electronic Trading System (ETS) which was commissioned in 2006. A Wide Area Network (WAN) platform was implemented in 2007 and this eradicated the need for brokers to send their staff (dealers) to the trading floor to conduct business. Trading is now mainly conducted from the brokers' offices through the

WAN. However, brokers under certain circumstances can still conduct trading from the floor of the NSE.

Two indices are popularly used to measure performance. The NSE 20-Share Index has been in use since 1964 and measures the performance of 20 blue-chip companies with strong fundamentals and which have consistently returned positive financial results. Included in the Index are Mumias Sugar, Express Kenya, Rea Vipingo, Sasini Tea, Uchumi Supermarkets Ltd. Kenya Airways, Safaricom, Nation Media Group, Barclays Bank Kenya, Equity Bank, Kenya Commercial Bank, Standard Chartered Bank, Bamburi Cement, British American Tobacco, Kengen, Cooperative Bank of Kenya, East African Breweries, KenolKobil, Kenya Power & Lighting Company Ltd. and Athi River Mining. This index primarily focuses on price changes amongst these 20 companies.

In 2008, the NSE All Share Index (NASI) was introduced as an alternative index. Its measure is an overall indicator of market performance. The Index incorporates all the traded shares of the day. Its attention is therefore on the overall market capitalization rather than the price movements of select counters. This study will use NASI as a measure of stock performance.

**([www.nse.co.ke](http://www.nse.co.ke))**

### **1.3 Statement of the problem.**

A number of studies have been undertaken establishing the relationship between the performance of stock exchange in the world and political activities in specific countries. Most of these studies were carried out in developed stock exchanges. Studies on the effect of political activities on the performance of emerging capital markets are very important as more and more investors participate in these markets.

The investors in emerging markets are local and the number of foreign investors continues to increase overtime. Developed economies such as the U.S. operate in different social, economic and political environments than those found in emerging markets. The performance of the stock market following a major political event such as general elections and its relationships with market performance has been documented in the United Kingdom and the United States of America (Stovall. 1992; Hudson et.al, 1998).

Various studies have been done in other countries on the behaviour of stock market returns during and after election dates. These studies indicate that the stock markets returns react strongly before and after elections. Other studies indicate that the stock markets follow a pattern of an election cycle. In the cycle the stocks shows a higher return on average on the two years preceding the election date. It is specifically noted in these studies that the stock market returns are on average negative on the second year following an election.

Hudson et al. (1998) consider the British post-war share price movements, in both the short and the long-term. Their first major finding is that the market responds positive (negative) to a Tory (Labour) election victory. This was found by looking at the stock market's movement after the election's result has been announced: usually the day after the elections.

In their research on the German stock market and politics, Dopke and Pierdzioch (2006) find "no strong evidence for political or election cycles in stock returns", even though their results do suggest that stock market movements may influence the government's popularity and therefore the possible re-election of that government.

Bialkowski et al (2006) studied the behavior of stock markets around national elections. In his study he analysed the behavior of the stock markets around elections in twenty seven



countries. He found out that the volatility of the stock markets of the specific countries included in his sample increased during an election period. He indicated that narrowing the event window magnifies the implied percentage change in variances which suggest that most of the hike is due to large market moves on the Election Day.

Stock market behavior is very crucial in stock returns predictability. Investors no longer have assurance of superior returns just because the earning power of the firm has increased. But the political factors also contribute to investors returns. Knowledge of the market reaction to political factors is of great importance to investors because of market variations. Where such variations exist they would signal the right time to buy or sell stocks. The Kenyan Securities market has become more dynamic while the investors have become more knowledgeable such that in a market that exhibits strong variations the strategy of buying low and selling high will work to some extent. Such variations would signal the right time to buy or sell stocks in order for an investor to earn abnormal returns assuming that the market is not perfect.

This study therefore sought to investigate stock market performance 6 (six) months before and 6 (six) months after the promulgation of the new constitution (2010) at the Nairobi Securities Exchange examining the daily stock index. The event day is 27<sup>th</sup> August, 2010 and the period of the study will be from 27<sup>th</sup> February 2010 to 26<sup>th</sup> February 2011.

#### **1.4 Objective of the study.**

The objective of the study was to investigate stock market performance before and after the promulgation of the new constitution (2010) at the Nairobi Securities Exchange.

## **1.5 Significance of the study**

There are various stakeholders who will benefit from this study:

**Financial Analysts:** They will use the information from this study to clearly advise their clients on investment strategies during a major political period such as change of the constitution, general election among others.

**Portfolio Managers:** They will use the information from this study to educate the general public to understand the performance of NSE during a major political period such as change of constitution, general election among others. This will help them make better and informed investment decisions in order to maximize the gains in their portfolio holdings.

**Current and prospective local and foreign investors:** The study will give investors useful information concerning the likely performance of NSE during a major political period such as change of constitution, general election among others. This will assist them in determining their investment decision through the NSE.

**The Government:** As a regulator will use the information from this study to be able to monitor the performance of stock market as a measure of economic growth and also to determine the timing of privatization of state corporations through the NSE.

**Academicians:** Results from this study will also add to body of existing knowledge on this area and form basis of further research on related areas.

## CHAPTER TWO

### 2.0 LITERATURE REVIEW

#### 2.1 Stock Market Performance.

A stock market is an institution that deals in exchange of securities issued by publicly quoted companies and the government. The stock market is part of the broader market referred to as financial market (Reilly. 1997; Fabbozi 1995).

The issue of political events' ties to financial market performance has been the subject of a plethora of studies (Lamb et al. (1997). The empirical literature on the link between stock market performance and political elections dates back to Niederhofer, Gibbs, and Bullock (1970) who studied market behaviors around U.S. elections. Allivine and O'Neill (1980), Herbst and Slinkman (1984). and Huang (1985) found evidence in support of the presidential election cycle theory. Recent evidence in the area also includes the study by Foerster (1994) who showed that the U.S. presidential election effect also occurs for Canadian stocks. Foerster and Schmitz (1997) provided evidence of the pervasiveness of the U.S. presidential election cycle in international stock market returns.

Another related study that examined the impact of political elections on stock market indices is Pantzalis, Stangeland. and Turtle (2000). They analyzed the behavior of stock market indices across 33 countries around political election dates for a sample period of 1974-1995. They presented evidence indicating that elections do impact stock markets across their sample countries. Nippani and Medlin (2002) employed the event study test to examine the impact of the delay in the declaration of the 2000 U.S. presidential election winner on the stock market and their results indicated that the market reacted negatively to the delay. Santa-Clara and Valkanov (2003) documented that excess returns correlate with presidential-

partisan cycles and tested some obvious hypotheses as the provenance of this correlation. They found that the presidential cycle variables capture information about returns that are not correlated with business cycle variables and there is no evidence of large excess returns around the election dates.

Chiu, Chen, and Tang (2005) investigated the relationship between foreign investors' trading behaviors and the political election events on South Korea's financial market via a bivariate GARCH (1,1) model analysis. In particular, foreign investors showed a significant decrease in trading options contracts during the parliamentary election periods and the parliamentary elections stabilized the derivatives' trading volatility. It is obvious that the presidential elections are a more important source of uncertainty compared to parliamentary elections. All these previous studies indicate that political elections are widely-watched events by stock markets and that election results do impact the performance of stock markets.

In Kenya election period is associated with great uncertainty that presents challenges for investors at the Nairobi Securities Exchange. The NSE can be categorized as an emerging market which can be affected by events bringing uncertainty to the market. Richard (2006) cites the following events that may bring security price changes: earnings report, new product releases, trade show presentations, bonus issues, IPO's and dividend announcements. In his study he cited national elections, government economic and commodity data releases, Federal Reserve Board announcements, government policy decisions and OPEC statements as some of the events that lead to anticipatory and reactive security price movements in the stock markets.

Ngugi (2008) in his study on stock market performance before and after general election at the NSE found that NSE performance was influenced by the political activities around the election period in the short term. His study also revealed that the first two years after the

general elections the NSE performed better than the last two years before the general elections. He attributed the poor performance to investors' anxiety and panic associated with pre-election period.

## **2.2 Review of theories.**

Various theories have been developed that try to relate the Stock prices and a major political period such as election periods, change of constitution among others. They include: Efficient Market Hypothesis (EMH), the random walk theory and Political Business Cycle Theory. They are explained below: -

### **2.2.1 Efficient Market Hypothesis (EMH).**

The efficient market hypothesis states that all securities prices must reflect all information. Fama (1970) made a distinction between three forms of EMH: a) The weak form, (b) The semi-strong form and (c) The strong form. According to EMH, stocks always trade at their fair value on securities exchanges, making it impossible for investors to either purchase undervalued stocks or sell stocks for inflated prices. Supporters of this theory believe that it is possible to search for undervalued stocks or try to predict trends in the market through Fundamental analysis or Technical Analysis. This theory has been subjected to too much research and analysis and has been a major source of discussion for academicians. Copeland and Galai (1988).

Prior to the 1950's, it was believed that traditional investment analysis could be used to outperform the stock market. In 1950's studies emerged for example Kendall (1953) that changes in security prices followed a random pattern. This generated theories and research that led to the efficient market notion. (Lofthouse. 2001).

In a perfectly efficient market there is no mispricing. Therefore, there is no possibility to generate abnormal returns. Abnormal returns are actual returns minus normal returns. Normal returns are calculated using asset pricing models such as the Capital asset pricing model (Sharpe, 1964), the arbitrage pricing theory (Ross, 1980) and the three factor model (Fama and French, 1993). There are many other asset pricing models taking risk and other fundamental factors into account. The problem with the EMH is that if it is tested empirically a joint testing hypothesis is done. Not only the EMH is tested, but also the asset pricing model used to test the EMH (Fama, 1970)

### **2.2.2 Random Walk Theory.**

Random walk theory is a financial theory which claims that market prices follow a random path up and down without any influence by past movements thus making it impossible to predict with accuracy which direction the market will move at any point. (Maurice Kendall, 1953). The logic of the random walk theory is that stock prices follow a random walk path that cannot be determined from historical price information especially in the short run.

A follower of the random walk theory believes that it is impossible to outperform the market without taking an additional risk. However some proponents of this theory do acknowledge that the markets gradually upwards in the long run.

Lofthouse (2001) and Sharpe (2001) work found that security prices move in a random manner and that it is impossible to beat the market except by chance. The paradox of efficient markets is that if every investor believes a market is efficient, then the market will not be efficient because no one would analyze securities.

Gupta and Basu (2007) documented a study on weak form of efficiency in India stock markets which is published in international business and economics research journal. They

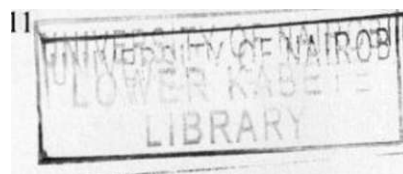

tested the weak form of efficiency of the emerging markets, in the framework of random walk hypothesis for two equality markets in India for the period of 1991-2006. They used run test and LOMAC variance ratio test to test the weak form of efficiency and Random walk hypothesis. They concluded that these markets were not weak form efficient, the series didn't follow random walk model and there was a widerence of auto correlation in both markets rejecting the weak form of efficiency hypothesis.

### **2.2.3 Political Business Cycle Theory.**

This theory is based on the assumption that voters consider their financial situation when voting. Policy makers may thus generate a rising stock market by manipulating policy instruments. They may also promise to make the stock market perform well after being elected or re-elected. This increases the stream of expected returns from the stock.

Nordhaus (1975) postulates that, irrespective of their political orientation, incumbents will pursue policies that maximize their chances of re-election. As a result they will try to self-attune the business cycle to the timing of elections. The economy will be stimulated by unsustainable expansionary policies before elections, and harsh actions aimed at curbing the resultant inflation will have to follow at the beginning of the new term of office.

Empirically, the political business cycle theory implies that policy makers systematically aim for a rise in the stock prices in periods preceding elections. However it does not necessarily mean that policy makers have not used policy instruments for their re-election or that the political business cycle does not exist even when no political effect is detected on the stock market. It only shows that investors have not adjusted their perception of the stream of dividends and the expected return to the policy moves.

## **2.3 Factors affecting stock prices in the market.**

Like any other commodity in the stock market, share prices are also dependent on a wide range of factors. Stock markets may experience a general increase in price level referred to as a bull market or general decrease in price level referred to as bear market. Stagnant prices or sudden big price movements downward is referred to as stock market crash.

Some of the major factors include: Demand and Supply of shares in the market, News related to a firm. Market capitalization of the company. Earnings report and dividend announcement, Inflation and Interest rates and political factors. They are highlighted as below: -

### **2.3.1 Demand and Supply of shares in the market.**

One of the major factors affecting stock price is demand and supply. The trend of the stock market trading directly affects the price. When people are buying more stocks, then the price of that particular stock increases. On the other hand if people are selling more stocks, then the price of that stock falls.

As supply and demand for security change overtime, different types of investors are attracted to the market. If the risk preferences of the investors are not as those of current investors the required rate of return tend to shift .Accordingly price relationship will change quite independently of any modification in earnings expectations. Participation by institutional investors at Nairobi Stock Exchange influences pricing and returns generated at the stock market (Reilly, 1997).

### **2.3.2 Impact of news related to a company.**

News is another factor that affects the share price. When there is positive news about a particular stock or company, people try to invest all their money in that particular stock or market. This leads to increase in the interest of buying the stock. But there are many



circumstances where news could also bring a negative effect where it could ruin the prospect of the particular stock. So it is very important to know the overall news of a stock or company where you can invest your money so that it grows within a very short period of time.

### **2.3.3 Market Capitalization of the company.**

Major capitalization changes involve stock split, bonus issues and right issues. According to the logic of the EMH, capitalization changes should not affect the value of the shareholders wealth. However, when there is a change on those measures share prices changes accordingly.

When a company declares a stock split, the price of the stock will decrease, but the number of shares will increase proportionately. A stock split has no effect on the value of what shareholders own. If the company pays a dividend, your dividends paid per share will also fall proportionately. Companies often split their stock when they believe the price of their stock exceeds the amount smaller individual investors would be willing to pay for stock. By reducing the price of stock, companies try to make their stock more affordable to these investors.

A study by Byun and Rozeff(2003) studied the post split performance of 12,747 stocks in the US for the period 1927 to 1996. They used two different methods: size and book-to-market, and calendar-time abnormal returns. They found that the appearance of significant abnormal returns is sensitive to the time period, method of estimation, and sampling. Both methods applied to splits 25 percent or larger did not find performance significantly different from zero. Sub- periods and sub-samples of 2-1 splits by book-to-market displayed positive abnormal returns.

### **2.3.4 Earnings report and Dividends announcement.**

Now when it comes to the term, "earning per share", it means the profit that a particular company has made per share and that too on the last quarter. If you need to know the health of the company then this is the most important factor. What's more earning per share also influences the buying tendency in the market that results in the increase of the particular stock price.

Dividends are important to shareholders because of their implied relationship to the current and future profitability of the firm. Changes in a stock's dividend rate leads to a change in the price of the stock. It is argued that a change in a firm's dividend rate is likely to be seen as management's view of future profit.

Modigliani and Miller (1958) showed that a firm's value is determined by its investment decisions and not by its financing decisions. In a companion paper, Miller and Modigliani (1961) extended the basic results by showing that, given investment decisions, dividend policy is also irrelevant. Miller and Modigliani's irrelevance proposition implies that if financial markets are perfect, corporate financial policies including dividend policy, are irrelevant.

An outstanding work on the determinant of stock prices was developed by Brown (1970) which was to report some preliminary attempts and methodology. He proposed that the total market value of the firm relates to the firm future earnings. Three types of data was used between 1958 and 1968; annual earnings per share (EPS), EPS announcement dates; and share prices. He studied the factors affecting investment in the electric utility industry and concluded that one major determinant of the stock prices was company earnings.

### **2.3.5 Inflation and Interest rates.**

One of the more predictable influences of the stock market are periodic adjustments of interest rates by the Central Bank to combat inflation. When interest rates are raised, many investors sell or trade their higher risk stocks for government-backed securities such as bonds to take advantage of the higher interest rates they yield and to ensure that their investments are protected.

### **2.3.6 Political factors.**

A lot of political factors also can drastically change the market scenario. Political factors like changes in government, changes in a country's diplomatic relations with another, change of a country's constitution and even a foreign tour by a diplomat can have a profound effect on the country's stock market. We all must comprehend that a country's economy goes hand in hand with its political stability. That is why this proposal will seek to investigate the stock market performance before and after the promulgation of the new constitution (2010) at the Nairobi Securities Exchange.

## **2.4 Studies on political events and stock returns and their findings.**

Several studies have looked at the relationship between a political event and stock market returns. These studies indicated a significant reaction of stock markets during a major political event such as election period.

Nordhaus (1975) was the first to investigate the link between economic performance and political events, developing a model of the political business cycle to explain why unemployment levels in the U.S. tend to drop prior to the presidential elections and then rise.

The findings demonstrated that government actively manages the economy, causing it to expand before presidential elections and then contract.

Most of literature on the link between politics and economic performance has focused on tracking stock market performance in relation to presidential elections (Foerster, 1994; Foerster and Schmitz, 1997). Previous researches suggest a close relationship between politics and stock markets. Recent studies found some significant evidence that political information affect the stock market behaviour (Bachman, 1992; Chan and Wei, 1996; Willard, Guinnane and Rosen, 1996; Bittlingmayer, 1998; Kim and Mei, 2001; Perotti and Oijen, 2001).

The question of election reaction, where the authors examined the immediate market reaction to the presidential election has been carried out. Studies using various event methodologies have provided consistent evidence that the immediate market reaction to the election of a Republican President is positive while the election of a Democratic President creates a negative market reaction. Siegel (1998) found that from 1888 to 1996 the election of a Republican President produced a positive market reaction, as measured in the change in the Dow Jones Industrial Average, while the election of a Democrat produced a negative market reaction. Two other studies of broad equity markets found similar results during the periods from 1900-1976 (Nieder. Gibbs and Bullock 1970).

Santa - Clara and Valkanov (2003) showed that the market excess return was higher under Democrat than Republican presidencies throughout the period from 1927 - 1998. The authors argue that such anomaly cannot be explained away by variation in business condition proxies.

Nosfinger (2004), contends that the stock market is a barometer of public sentiments and its movements can indicate whether incumbents will be re-elected.

In the British and the US exchanges, it is accepted that stock markets prefer a conservative administration. Ioannidis (1986) attempted to test this proposition by examining market returns around the time of elections. His study assumed that the election outcomes will be largely be influenced by the market on the basis of published opinions forecasts. He found that opinion movements towards a conservative government do exert a significant impact on the stock market, but only when two parties are relatively evenly balanced.

De Santis and Imrohorglu (1997) found that stock markets in emerging countries exhibit higher conditional probability of large price changes than stock markets in developed countries. Pantzalis, Stangeland and Turtle (2000) demonstrated that the positive abnormal stock return occurred when political power change. Based on the above researches, there may be an important role for political uncertainty in explaining these phenomena.

Bialkowski et al (2006) studied the behavior of stock markets around national elections. In his study he analysed the behavior of the stock markets around elections in twenty seven countries. He found out that the volatility of the stock markets of the specific countries included in his sample increased during an election period. He indicated that narrowing the event window magnifies the implied percentage change in variances which suggest that most of the hike is due to large market moves on the Election Day.

## **2.5 Event Studies.**

Event studies examine the effect of an announcement on share price as a test of the semi-strong form of the EMH. The initial focus of event studies was on the speed of incorporation

of information into the share price and trying to determine how long this process takes. However, it has since been confirmed empirically that prices react quickly to announcements and now commonly assumed that, given market rationality, the effect of an event will be reflected immediately into share prices.

Event studies start with hypothesis about how a particular event affects the value of a firm. The hypothesis that the value of the company has changed will be translated in the stock showing an abnormal return. Coupled with the notion that the information is readily impounded in to prices, the concept of abnormal returns (or performance) is the central key of event study methods. (Serra, 2002).

According to MacKinlay (1997), the initial task of conducting every event study is to define the event of interest and identify the period over which the security prices of the firms involved in this event will be examined.

Event studies are widely used in litigation to measure the effect of alleged misconduct by examining the share price impact of relevant disclosures. The event study method is commonly used in securities litigation for estimating the share price impact of events because it meets scientific standards. These standards include the following: it provides testable results that may be replicated by other analysts; it is supported by published literature; it produces estimates with a known rate of statistical error; and it has generally been accepted by the scientific community. (R. Weil, M. Wagner and P. Frank. 2001)

Sharpe, Alexander. Bailey (2003) indicate that event studies can be carried out to see just how fast security prices actually react to the release of information. Event studies will

therefore seek to answer the following questions: Do they react slowly or rapidly? Are the returns after the announcement date or event date abnormally high or low, or are they simply normal? They concluded that event studies are joint tests as they simultaneously involve tests of the asset pricing model's validity and tests of market efficiency. A finding that prices react slowly to information might be due markets' being inefficient, or it might be due to the use of an improper asset pricing model, or it might be due to both.

## **CHAPTER THREE**

### **3.0 RESEARCH METHODOLOGY**

#### **3.1 Introduction**

This Chapter will explain the overall methodology that will be used to collect the data to meet the objectives of the study. It will specifically look into research design, population, sample design, data collection and data analysis.

#### **3.2 Research Design**

This is an event study that sought to investigate stock market performance 6 months before and 6 months after the promulgation of the new constitution (2010) at the Nairobi Securities Exchange. The study examined the movement of share prices 6 months before the promulgation and 6 months after the promulgation of the new constitution. Since the event date is 27<sup>th</sup> August, 2010, the study therefore focused on NSE performance for the period between 27<sup>th</sup> February 2010 and 26<sup>th</sup> February 2011.

#### **3.3 Population**

The target population consisted of all the 58 companies listed at Nairobi Securities Exchange and continuously trading for one year from 27<sup>th</sup> February 2010 and 26<sup>th</sup> February 2011. The listed companies are as shown in Appendix I.

#### **3.4 Data collection**

This study used secondary data that were obtained from the NSE Library and data base. The data covered the period between 27<sup>th</sup> February 2010 and 26<sup>th</sup> February 2011. The event date was 27<sup>th</sup> August 2010 as it was the date when the new constitution was promulgated.



The study focused on NSE performance as measured using the NASI share index and stock prices on a monthly for the study period.

### 3.5 Data Analysis

The data collected was analysed by using the event study method based on the market model. The event window was 6 months before and after the promulgation date.

The NASI share index was used to measure the performance of the NSE from each trading day. An increase in the NSE share index indicated an upward trend of NSE performance which is referred to as bullish while a decrease in the NSE share index indicated a downward trend of NSE performance which is referred to as bearish.

The data on the price movement was presented according to the various market segments. This helped to indicate the effect of each market segment of the NSE by the promulgation of the new constitution.

Following French (1980) and Keim & Stambaugh (1984), regression model was used to analyze the returns. Regression analysis was used to analyze stocks returns against the market returns.

**Market model was represented as below:**

$$r_{it} = a + \rho r_{mt} \quad t = U, \dots, T$$

Where  $r_{jt}$  = The return on stock  $i$  in period  $t$ .

$r_{mt}$  = The return of the market in period  $t$

$a$  = Constant

P = Market Beta

Return on stock ( $r^{\wedge}$ ) = (closing price - opening price)/Opening price.

Market return (index) ( $r_{m1}$ ) =  $(P_i / P_0 - 1)$ ,  $(P_2 / P_1 - 1)$  and so on....

Where  $P_i$  = Closing NASI Share index for each segment at period 1.

$P_0$  = Opening NASI Share index for each segment at period 0.

$P_2$  = Opening NASI Share index for each segment at period 2.

**Average return for a certain period in a specific market segment was determined by:**

$$1/n \sum r_{it}$$

Where  $r_{it}$  = The return on stock / in period t.

n = The no. of securities in a segment at time t.

**The hypothesis test was as below:**

Null hypothesis: There is no difference in the performance of the stock market for the period before and after the promulgation of the new constitution.

Alternative hypothesis: There is a difference in the performance of the stock market for the period before and after the promulgation of the new constitution.

This is stated as follows:

$H_0: \mu_1 = \mu_2$

$H_1: \mu_1 \neq \mu_2$

**Where:**  $\mu_1$  = Mean of population 1

$\mu_2$  = Mean of population 2

**Critical assumption:**

**This study assumed that all other factors that affects stock prices in the market as outlined in chapter 2 (2.3) remained constant other than political factors.**

## CHAPTER FOUR

### 4.0 DATA ANALYSIS AND RESULTS

#### 4.1 Introduction

This section presents results of the performance of NASI share index and market returns of 35 stocks that fulfilled the selection criteria from a population of 58 stocks. The period under review was 6 months before and 6 months after the promulgation of the new constitution 2010. The results have been obtained from an analysis of NASI index and stock prices at the last trading day of each month. Analysis was mainly centered on obtaining the returns for both NASI index and stocks and regressed to give the beta factor of the period before and after the promulgation of the new constitution 2010. Beta factors were used to determine selection of the appropriate hypothesis. Further analysis was done using line graphs utilizing trends of the movement of the performance of the market to describe its patterns; this was used to understand the relationship between the period in question and the performance of the market during that particular period.

This chapter presents findings of the study with regard to the objective i.e. to investigate stock market performance before and after the promulgation of the new constitution (2010) at the Nairobi Securities Exchange. The focus was on all the 10 market segments in the Nairobi Securities Exchange.

## 4.2 Hypothesis Test

The tests are as follows:

Null hypothesis: There is no difference in the performance of the stock market for the period before and after the promulgation of the new constitution.

Alternative hypothesis: There is a difference in the performance of the stock market for the period before and after the promulgation of the new constitution.

This is stated as follows:

$$H_0: \mu_1 = \mu_2$$

$H_1: \mu_1 \neq \mu_2$

Where:  $\mu_1$  = Mean of population 1 (before promulgation)

$\mu_2$  = Mean of population 2 (after promulgation)

## 4.3 Market performance by market segment

This section discusses the performance of the stock market by segments. The objective is to determine the performance of the different market segments before and after the promulgation of the new constitution 2010.

### 4.3.1 Market performance for Agricultural Segment.

Analysis of data relating to the performance of the Agricultural segment reveals that the stock market performances declined by an average of 1.5% while the NASI share index was optimal. This results show that the null hypothesis is rejected and it is concluded that market performance was different hence accepting the alternative hypothesis.

These statistics are shown in the figure 4.1 below:

**Figure 4. 1 Market performance for Agricultural segment.**

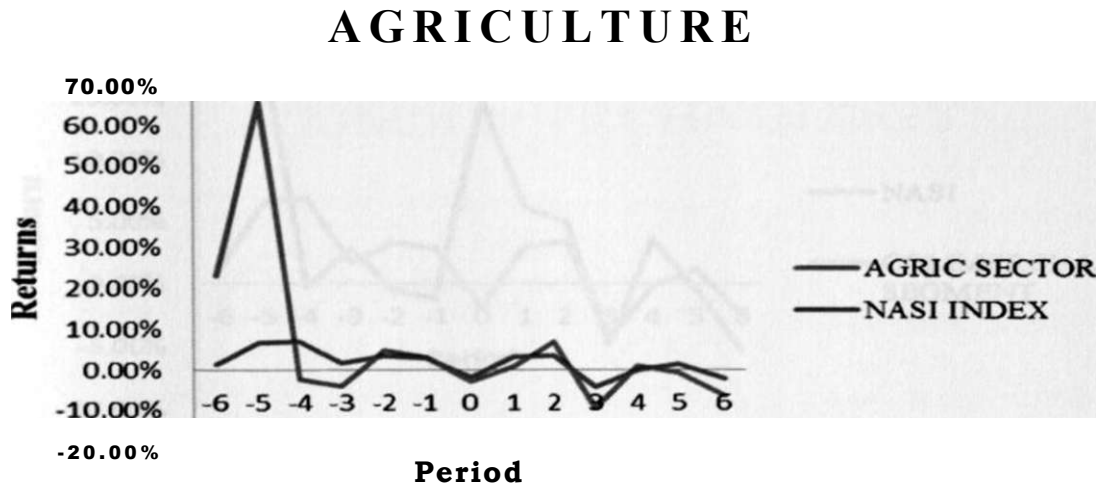

Source: Research findings

#### **4.3.2 Market performance for Commercial and Services Segment.**

This segment constitutes companies that are in the service segment. This segment has a total of 8 companies, however only 4 that were investigated as they satisfied the selection criterion. They are Kenya Airways, Nation Media Group, TPS Eastern Africa (Serena) Ltd and Scan group. This study investigated stock market performance before and after the promulgation of the new constitution (2010) at the NSE.

According to the analysis this segment was performing well before the promulgation of the constitution and poorly after the promulgation.

This results show that the null hypothesis is rejected and the researcher concluded that market performance was different hence accepting the alternative hypothesis.

These statistics are shown in the figure 4.1 below:

**Figure 4. 2 Market performance for Commercial and Services segment.**

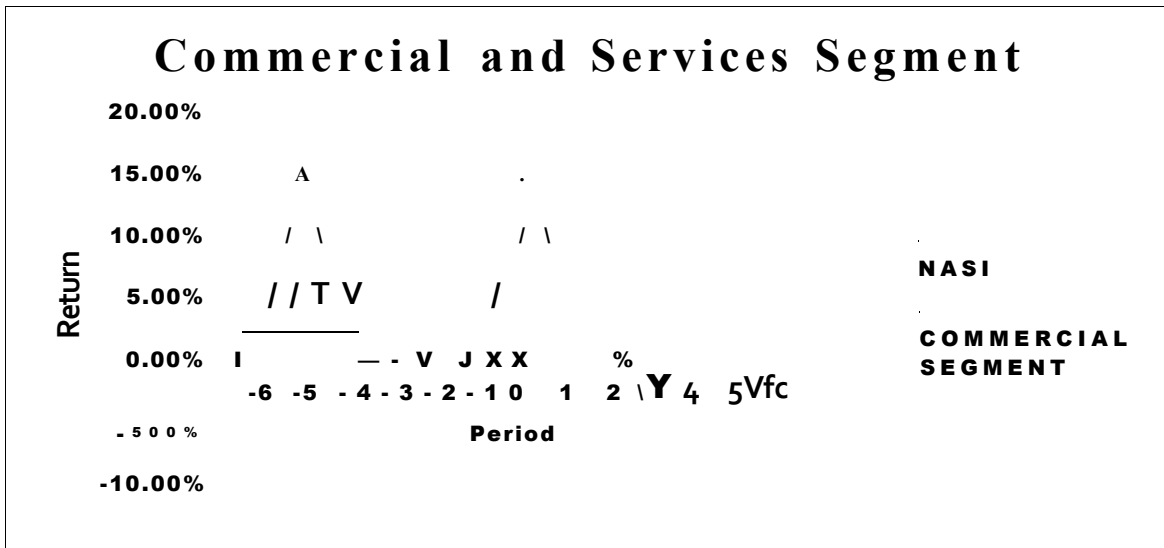

Source: Research findings

### 4.3.3 Market performance for Telecommunication and Technology Segment.

This segment consist of 2 stocks namely Access Kenya Group and Safaricom ltd. The stock for this segment were collected and analyzed. The research findings reveals that the stock's performance was poor before the promulgation and very poor after the promulgation to as low as negative 19.3%.

Whereas the investors expected better returns, the actual returns fell short of their expectations during the days preceding the promulgation. On the days after the promulgation the trend indicates very low actual returns than the expected returns. This could be attributed to investors uncertainty due to the perceived freedom of communication entrenched in the new constitution.

This results show that the null hypothesis is rejected and it is concluded that market performance was different.

These statistics are shown in the figure 4.3 below:

**Figure 4. 3 Market performance for Telecommunication and Technology<sup>1</sup> segment.**

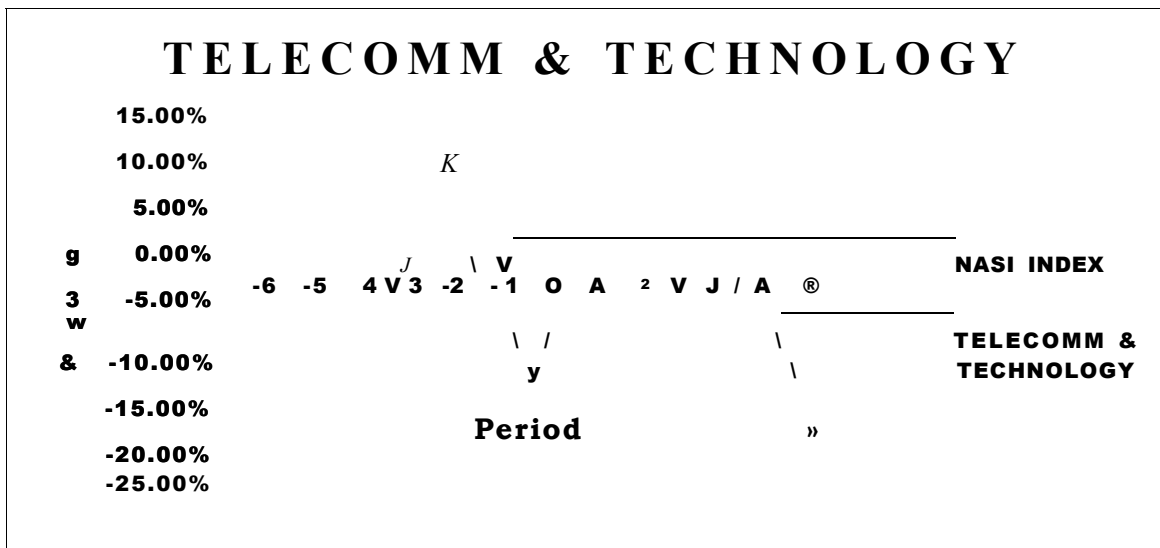

Source: Research Findings

#### 4.3.4 Market performance for Automobiles and Accessories Segment.

In this segment only 2 stocks namely CMC Holdings and Sameer Africa Ltd that fulfilled the selection criteria. The research findings indicate that the performance decreased after the event date and sharply increased after the 4<sup>th</sup> period and fall drastically afterwards.

The performance could be attributed to the investor's anxiety due to the implementation of the new constitution.

This research findings reveal that the null hypothesis is rejected as the market performance is different thus alternative hypothesis is accepted.

These statistics are shown in the figure 4.4 below:



Figure 4. 4 Market performance for Automobiles and Accessories segment.

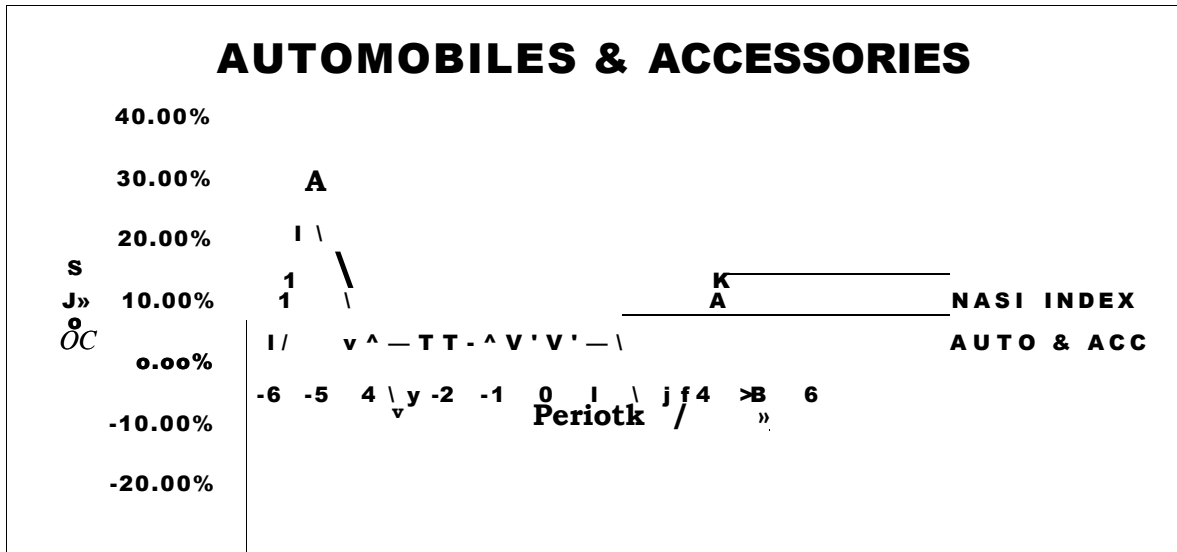

Source: Research findings

#### 4.3.5 Market performance for Banking Segment.

This segment contains 10 stocks and all of them were selected in this study. This segment has the highest representation as opposed to other segments in the NSE.

The research finding reveals that the banking segment performed very well to a maximum of 12% before the promulgation of the new constitution. This trend declined to negative 4% in the 3<sup>rd</sup> month after promulgation and later gained to 6% in the 5<sup>th</sup> month. The upward movement was not sustained as the performance decreased in the 6<sup>th</sup> month after the promulgation to negative 4%.

The results findings reveal that the null hypothesis is rejected and alternative hypothesis accepted.

These statistics are shown in the figure 4.5 below:

Figure 4. 7 Market performance for Investment segment.

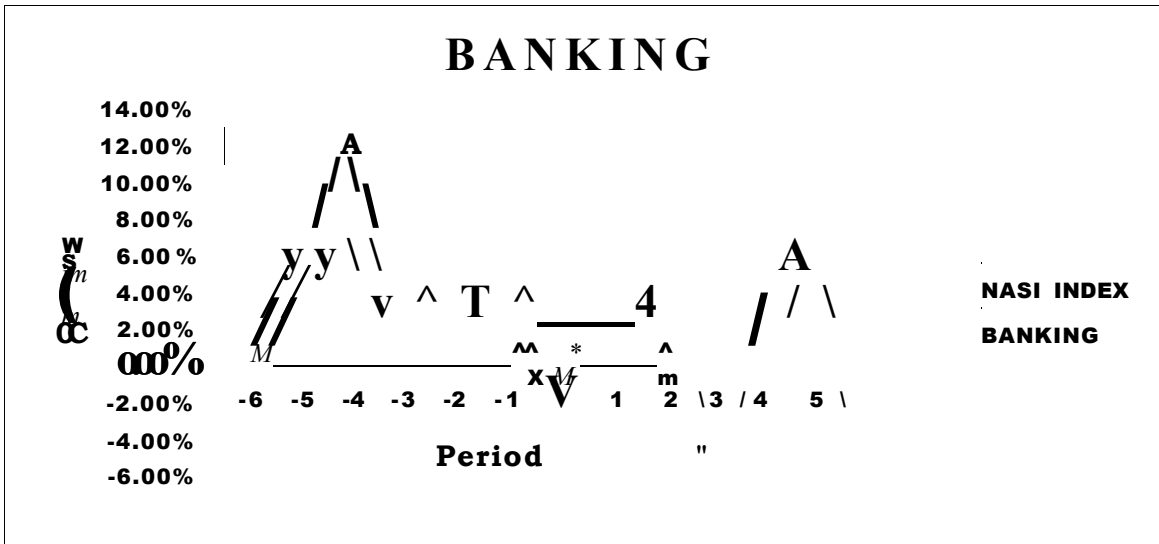

Source: Research findings

#### 4.3.6 Market performance for Insurance Segment.

This segment consists of 5 stocks out of which only 2 satisfied the selection criteria. They are Jubilee Holdings and Kenya Re-Insurance Corporation Ltd.

The study analysis reveals that the segment performed slightly better before the promulgation to a maximum of 15% and performed poorly after the promulgation of the new constitution to as low as negative 5%. It further reveals that after the promulgation only period 2 and period 5 registered a positive return of 2% and 4% respectively while the other periods yielded negative returns.

The results findings reveal that the null hypothesis is rejected and alternative hypothesis accepted.

These statistics are shown in the graph 4.6 below:

Figure 4. 7 Market performance for Investment segment.

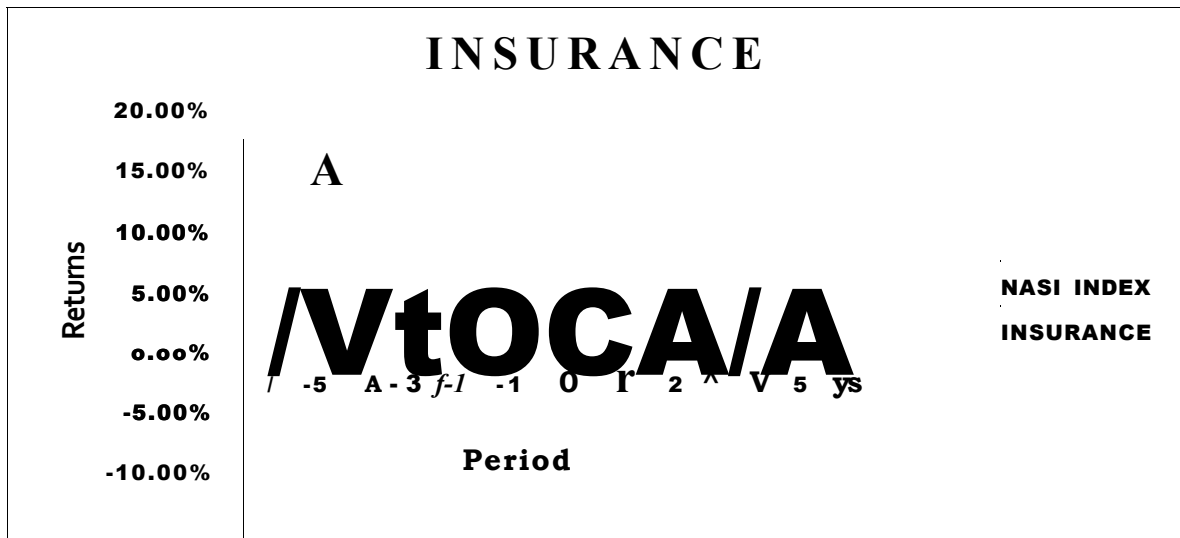

Source: Research findings

#### 4.3.7 Market performance for Investment Segment.

This segment consists of 4 stocks out of which only Centum Investment satisfied the selection criteria. This is the segment that had the lowest representation.

The research findings revealed that the segment performed better before the promulgation to an average of 9% and poorly after the promulgation to an average of negative 3%. This can be attributed to investor's uncertainty in the implementation of the new constitution i.e. a "wait and see" scenario before taking an investment decision.

The results findings reveal that the null hypothesis is rejected and alternative hypothesis accepted.

These statistics are shown in the graph 4.7 below:

Figure 4. 7 Market performance for Investment segment.

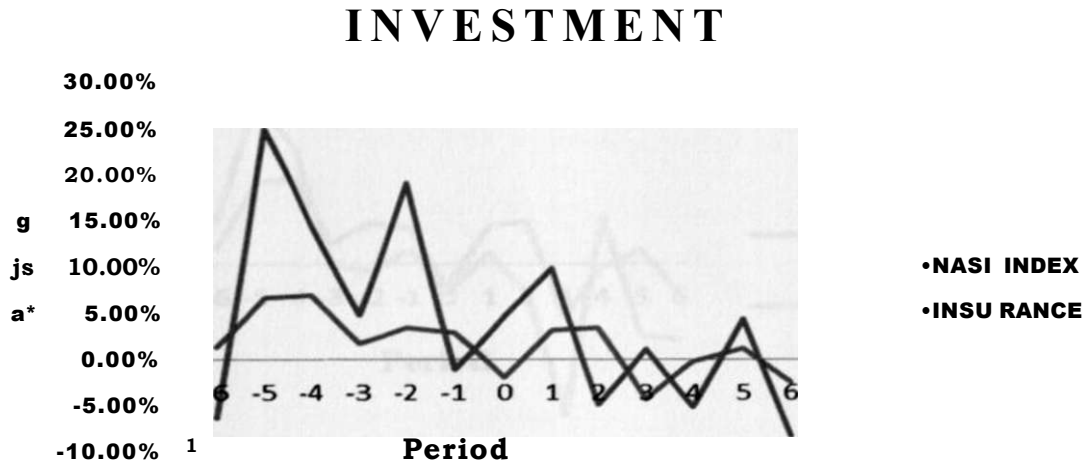

Source: Research findings

#### 4.3.8 Market performance for Manufacturing and Allied Segment

The segment consists of 9 stocks out of which only 4 were selected. They include East African Breweries, Mumias Sugar, Unga Group and Eveready East Africa Ltd.

The research findings reveals that the segment performed somehow better before the promulgation to as high as 13% and poorly after the promulgation to as low as negative 12%.

The study also revealed that only period 1 and period 2 after the promulgation that the segment registered a positive return of 1% and 4% respectively all other periods after the promulgations registered a negative return.

The results findings therefore reject the null hypothesis and accept the alternative hypothesis.

These statistics are shown in the graph 4.8 below:

**Figure 4. 8 Market performance for manufacturing and Allied segment.**

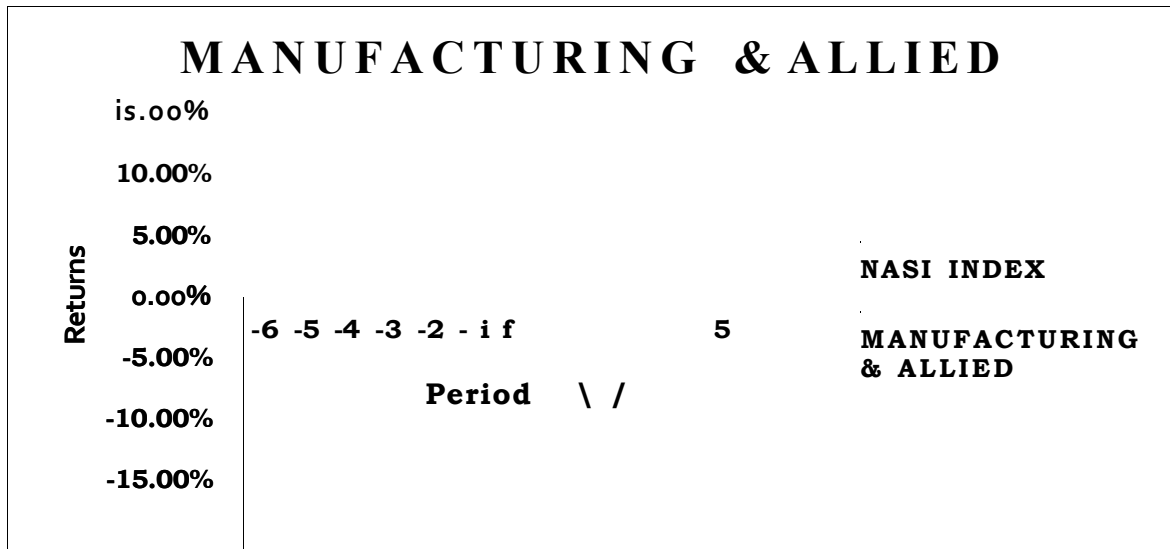

Source: Research findings

#### **4.3.9 Market performance for Construction and Allied Segment**

This segment consists of 5 stocks out of which 4 were selected in the study.

The study findings revealed that the segment performed much better before the promulgation to as high as 7% with only period 3 registering a negative performance of 2% whereas the segment performed poorly after the promulgation to as low as negative 9% in period 3.

On average the segment performed better before promulgation to an average of positive 3% and much poorer after the promulgation of the new constitution to an average of positive 0.1%.

The results findings thus reject the null hypothesis and accept the alternative hypothesis.

These statistics are shown in the graph 4.9 below:

Figure 4. 9 Market performance for Construction and Allied segment.

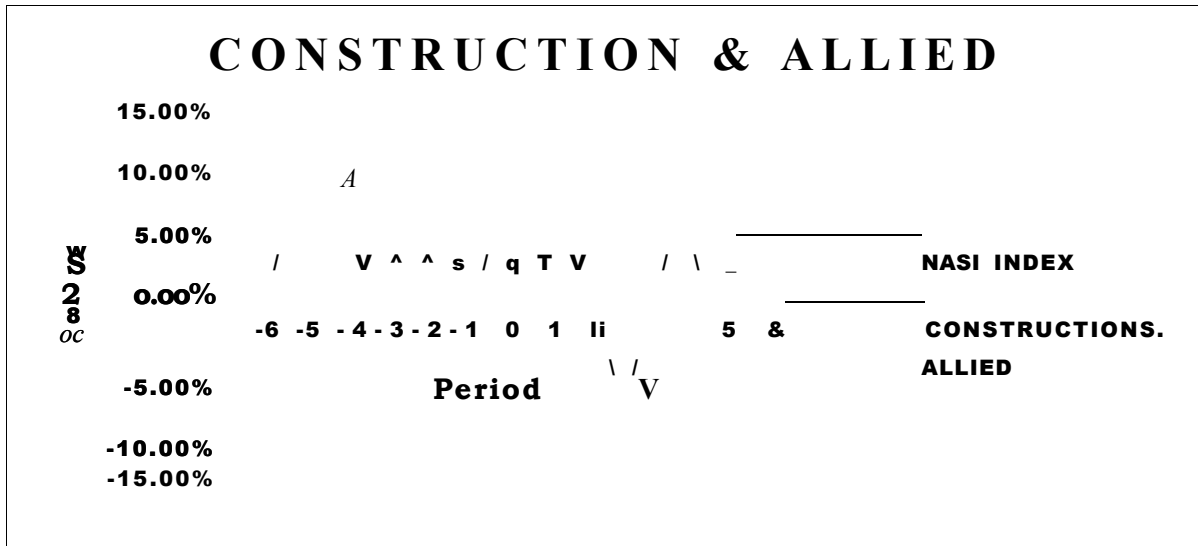

Source: Research findings

#### 4.3.10 Market performance for Energy and Petroleum Segment

This is the last segment in the NSE. It consists of 4 stocks and all of them were selected in this study. They include KenolKobil, Total Kenya, KenGen and Kenya Power & Lighting Co. Ltd.

The study analysis reveals that the segment performed much better before the promulgation to as high as 9 % and to as low as negative 3%. However the performance after the promulgation was as high as 7% and as low as negative 6%.

On average the performance before the promulgation was better with an average of positive 4.5% whereas the performance after the promulgation registered an average of negative 0.5%.

The results findings therefore reject the null hypothesis and accept the alternative hypothesis.

These statistics are shown in the graph 4.10 below:

**Figure 4. 10 Market performance for Energy and Petroleum segment.**

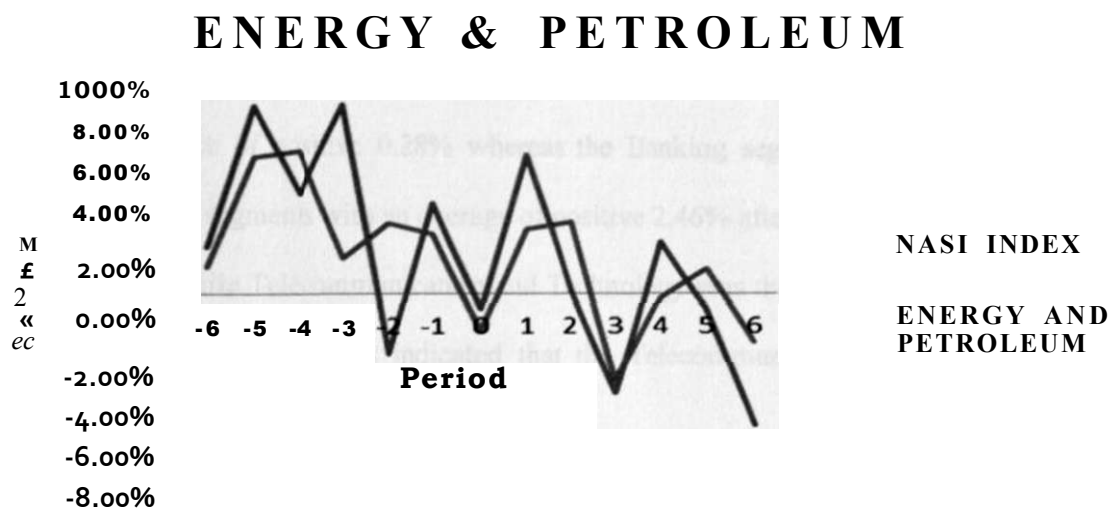

Source: Research findings

#### **4.3.11 General performance for all Market Segments and NASI Index.**

The market consists of 58 stocks which are sub divided in 10 segments. All the segments were selected in this study. From the 58 stocks only 35 stocks were selected as they fulfilled the selection criteria.

The research findings of the entire market reveals that all segments performed much better before the promulgation of the new constitution with an average performance of positive 5.21% while the performance after the promulgation declined to an average of negative 1.46%.

The NASI Index registered a performance of positive 3.82% before the promulgation and an average of 0.17% after the promulgation whereas the average performance at the event date was positive 1.47% with NASI index registering negative 1.85%.

The research findings reveals that the Agricultural segment performed much better than all other segments before the promulgation with an average performance of positive 15.1% while Telecommunication and Technology performed poorly and ranked as the last with an average performance of positive 0.28% whereas the Banking segment performance much better than all other segments with an average of positive 2.46% after the promulgation of the new constitution while Telecommunication and Technology was the least performer with an average of negative 5.7%. This indicated that the Telecommunication and Technology performed least before and after the promulgation.

The research findings further revealed that the Agricultural segment was the best overall performing segment in the study period i.e. before and after with an average of positive 6.13% and Telecommunication and Technology was the least performing segment with an average performance of negative 3.65%.

This results show that the null hypothesis is rejected and it is concluded that market performance was different hence accepting the alternative hypothesis.

These statistics are shown in the graph 4.11 below:



Figure 4. 11 Market performance for all segments combined.

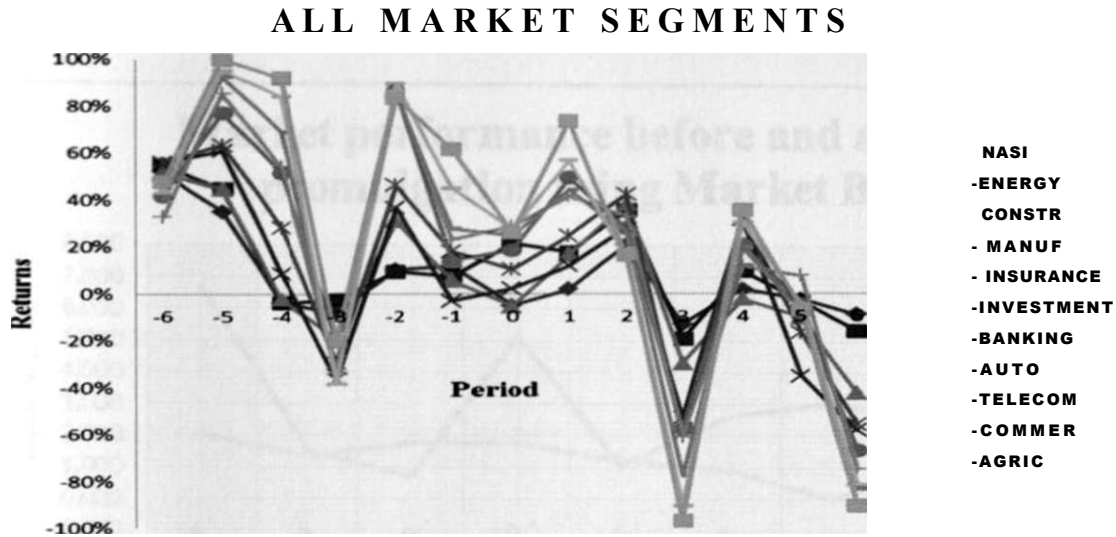

Source: Research findings

#### 4.4 Market performance using market beta.

The beta of a stock or portfolio is a number describing the volatility of an asset in relation to the volatility of the benchmark that said asset is being compared to. (Mark 2006). In this study this benchmark is NASI index.

The research findings reveal that the market performed much better before and worse after the promulgation of the new constitution. In terms of market beta Agricultural segment had the highest beta factors in both study periods i.e. before and after promulgation while Investment segment reported a negative beta after the promulgation of the new constitution 2010. (Appendix V).

This results show that market performance was different hence accepting the alternative hypothesis.

These statistics are shown in the figure 4.1 below:

Figure 4. 12 Market performance for all segments using market Beta..

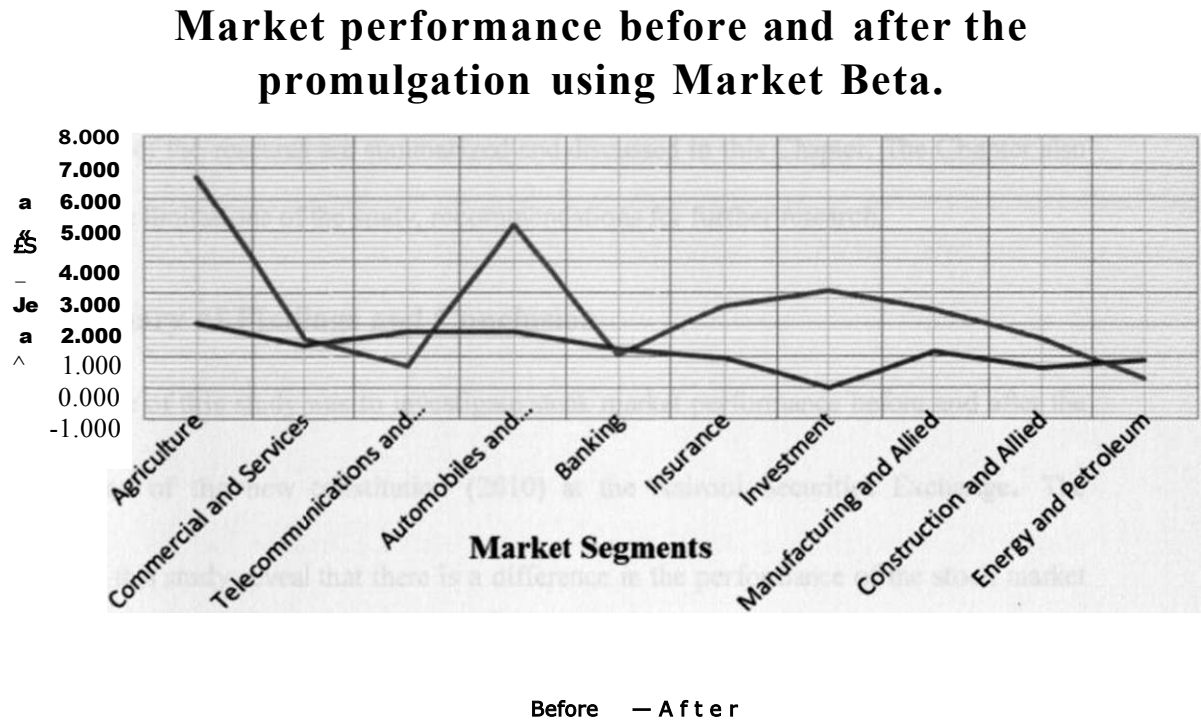

Source: Research findings

## CHAPTER FIVE

### 5.0 SUMMARY, CONCLUSION AND RECOMMENDATIONS

#### 5.1 Introduction

The findings of the research are summarized and discussed in this Chapter. The Chapter also highlights the limitations of the study, recommendations for further research.

#### 5.2 Summary of Findings and Conclusion

The objective of this study was to investigate stock market performance before and after the promulgation of the new constitution (2010) at the Nairobi Securities Exchange. The findings of this study reveal that there is a difference in the performance of the stock market for the period before and after the promulgation of the new constitution in all the 10 segments of the NSE.

The results further reveal that all the segments performed much better before the promulgation and poorly after the promulgation of the new constitution. In terms of performance agriculture segment was ranked as the best performing segment while telecommunication and technology segment was ranked as the least performing segment.

The study also shows that before the promulgation as well as the event date the average market performance was positive whereas after the promulgation the market performance declined to negative returns.

In conclusion the study shows that the stock market performed better before the promulgation of the new constitution 2010.

### **5.3 Limitations of the Study**

Several limitations were encountered during the study and are highlighted as below.

1. The major limitation was time and type of data. The type of data that was used was secondary. The study did not consider any primary data. Therefore the findings are based on the assumptions made from the analysed secondary data.
2. The period of the study was limited to 12 months i.e. 6 months before and 6 months after the promulgation of the new constitution 2010. Better results would be possible where the study period is longer with a stock market that has been in existence for a long time.
3. This study did not consider other factors that may affect the performance of the stock market other than the political factors.
4. NSE daily data were not available in some date especially the actual event date and as such month end data was used for the entire study.

### **5.4 Recommendations for further study**

The result of this study are not conclusive, therefore what the researcher of this study has achieved can only be considered to be little hence requiring further research work. The researcher offer the following recommendations for further study which should act as a direction to future researchers in order to discover more facts concerning this area of study and shed more light.

1. Investigation of other factors such as Demand and Supply of shares in the market, News related to a firm. Market capitalization of the company, Earnings report and

dividend announcement. Inflation and interest rates that influence stock market performance should be researched on.

2. A replication of this study should be done after some time to find out if there are any changes that have taken place and comparison with the current data be done.
3. A research can also be done to find out the reason why the response to security prices is not uniform across all the market segments. This will help understand why some segments are worse hit than others when it comes to the impact of a major political event on stock market securities.
4. A replication of this study can be done using GARCH methods and compared with the results of market model.

## REFERENCES

- Allvine, F.C. and D.E. O'Neill (1980). "Stock Market Returns and the Presidential Cycle." *Financial Analyst Journal* (October): 49-61
- Bachman, D., 1992. The effect of political risk on the forward exchange bias: the case of elections. *Journal of International Money and Finance* 11. 208-219.
- Bialkowski, J. Gottschalk, K., Wisniewski, T.P (2006). "Stock market Volatility around national elections." Downloaded from postgraduate research programmer's homepage. <http://viadrina.euv-franfurt-o.de/gk-wiwi>
- Bittlingmayer, G. (1998). Output, Stock Volatility, and Political Uncertainty in a Natural Experiment: Germany, 1880-1940, *Journal of Finance* 53(6): 2243-2258.
- Block, S. (2001b). "Political conditions and Currency Crises: Empirical Regularities in Emerging Markets." Working paper. No. 79, October. Cambridge, MA: Harvard University, Center for International Development.
- Chan, Y. and Wei, J. (1996). Political Risk and Stock Price Volatility: The Case of Hong Kong. *Pacific Basin Finance Journal* 4(2-3): 259-275.
- Chiu, C. L., Chen, C. D. and Tang, W. W. (2005). Political Elections and Foreign Investor Trading in South Korea's financial Markets, *Applied Economics Letters* 12(11): 673-677.
- Copeland, T and D. Galai (1988): "Information effects on the bid ask price" *Journal of Finance*, Vol.38, pp. 1457-1469.

- De Santis, G., Imrohorglu. S., 1997. Stock returns and volatility in emerging financial markets. *Journal of International Money and Finance* 16, 561-579.
- Dopke, J., Pierdzioch, C. (2006). Politics and the stock market: Evidence from Germany. *European Journal of Political Economy*, 22, 925-943.
- Fabozzi F. & Modigliani F. (1995). Capital Market Institutions and Instruments. New Jersey: Prentice Hall. Inc.
- Fama E.F. (1970). "Efficient capital markets: A review of theory and Empirical work", *Journal of Finance*, Vol.30, pp. 383-417.
- Fama. E., & French, K. (1993). Common Risk Factors in the Returns on Bonds and Stocks. *Journal of Financial Economics* 33 (1993), 3-53.3.
- Frank K Reilly & Keith C. Brown (2003). "Investment and Portfolio Management." Southwestern Educational Publishing, 9<sup>th</sup> Edition.
- French. K.R. 1980. Stock Returns and the Weekend Effect. *Journal of Financial Economics*, 8: 55-69.
- Foerster, S. R., 1994. Stock Market Performance and Elections: Made-in-Canada Effects? *Canadian Investment Review*, 39-42.
- Foerster, S. R. and J. J. Schmitz, 1997, The Transmission of U.S. Election Cycles to International Stock Returns, *Journal of International Business Studies*, 28(1), 1-27.
- Gupta, R. and Basu. P.K. (2007). "Weak Form Efficiency in India Stock Markets," *International Business & Economics Research Journal*. 6 (3): 57-64.

- Harms, P. (2002). Political Risk and Equity Investment in Developing Countries, *Applied Economics Letters* 9(6): 377-80.
- Hassan. M. K., Maroney, N. C., El-Sady, H. M. and Telfah, A. (2003). Country Risk and Stock Market Volatility, Predictability, and Diversification in the Middle East and Africa, *Economic Systems* 27( 1): 63-82.
- Herbst. A. F. and C. W. Slinkman. 1984, Political-Economic Cycles in the U.S. Stock Market, *Financial Analysts Journal*, 40(2), 38-45.
- Huang. R. D. 1985, Common Stock Returns and Presidential Elections, *Financial Analysts Journal*, 41(2), 58-62.
- Hudson. R., Keasey, K., Dempsey, M. (1998). Share prices under Tory and Labour governments in the UK since 1945. *Applied Financial Economics*, 8, 389-400.
- Jones T. (2002). "Presidential Elections Cycles and Stock Market Returns." Conference paper for the American Academy of Accounting and Finance.
- Keim, D.B., & F Stambaugh. (1984): "A further investigation of weekend effects in stock returns", *Journal of Finance*. Vol 39. pp. 819-840.
- Kendall, M. (1953): "The analysis of Economic time series". *Journal of the Royal statistical Society*, Series A, 96 pp. 11-25.
- Kim. H. Y. and Mei, J. P. (2001). What Makes the Stock Market Jump? An Analysis of Political Risk on Hong Kong Stock Returns. *Journal of International Money and Finance* 20(7): 1003-1016.



Levinson. Mark (2006). Guide to Financial Markets. London: The Economist (Profile Books). Pp. 145-6, ISBN 1-86197-956-8.

Lofthouse. S (2001): "Investment management" *Journal of Finance*, Vol.47, pp. 275-301.

MacKinlay A.C., 1997. —Event Studies in Economics and Finance, *Journal of Economic Literature*, Vol. 35, p. 13-39

Niederhofer. V., S. Gibbs. and J. Bullock, 1970, Presidential Elections and the Stock Market, *Financial Analysts Journal*, 26, 111-113.

Nippani, S. and W. B. Medlin, 2002, The 2000 Presidential Election and the Stock Market, *Journal of Economics and Finance*, 26(2), 162-169.

Ngugi. W (2008): "Stock market performance before and after general election. A case study of Nairobi Stock Exchange". *Unpublished MBA project, VON*.

Nofsinger, J.R (2004). "The stock market and political cycles". Paper presented at the annual meeting of the Financial Management Association. New Orleans, L.A.

Nordhaus. W.D. (1975), "Political Business Cycle." *Review of Economics Studies*, 42, 169 - 190.

Pantzalis, C., D. A. Stangeland. and H. J. Turtle, 2000, Political Elections and the Resolution of Uncertainty: The International Evidence, *Journal of Banking and Finance*, 24(10), 1575-1604.

Perotti, E. C. and Oijen, P. V. (2001). Privatization, Political Risk and Stock Market Development in Emerging Economies, *Journal of International Money and Finance* 20( 1):43—69.

R. Weil, M. Wagner and P. Frank. The Role of the Financial Expert, Third Edition, edition. New York: J. Wiley & Sons, 2001.

Reilly F. & Brown C. (1997). Investment Analysis and Portfolio Management 5th Edition. New Jersey: Prentice Hall Inc.

Richard. L.P., (2006). "Buy on rumour: Anticipatory effect and Investor behavior." Downloaded from <http://www.marketpsvch.com/money.php>. Behaviour Finance Personality Test.

Riley, W.B. and Luksetich, W.A. (1980). The Market Prefers Republicans: Myth or Reality. *Journal of Financial and Quantative Analysis*, 15(3):541 -560

Roll. R.. & Ross, S. A. (1980). An Empirical Investigation of the Arbitrage Pricing Theory. *The Journal of Finance Vol. 35, No. 5 (Dec., 1980)* 1073-1103.

Santa-Clara, P. and R. Valkanov, 2003, The Presidential Puzzle: Political Cycles and the Stock Market. *Journal of Finance*, 58(5), 1841-1872.

Serra A.P., 2002, —Event study tests: A brief survey, *Universidade do Porto, Working papers da FEP*, no. 117, p.2-12

Siegel, J.J. (1998). "Stocks for the Long Run." New York: McGraw Hill.

Sharpe, W. F. (1964). Capital Asset Prices: A Theory of Market Equilibrium under Conditions of Risk. *The Journal of Finance* Vol. 19, No. 3 (Sep., 1964), 425-442.

Sharpe, W. (2001): "Capital Asset Prices: A theory of market equilibrium under Conditions of Risk", *Journal of Finance*, Vol. 19, pp. 425-442

Sharpe, W.F. Alexander, G.J, Barley, J.V. 2003. Investments, 6<sup>th</sup> Edition, Prentice - Hall, New Delhi, 2003

Willard, K., Guinnane, T., Rosen, H., 1996. Turning points in the civil war: views from the Greenback market. *American Economic Review* 86, 1001-1018.

## **APPENDICES**

### **APPENDIX I: Companies Listed on the NSE by market segment.**

#### **AGRICULTURAL**

Eaagads Ltd  
Kapchorua Tea Co. Ltd  
Kakuzi Ltd  
Limuru Tea Co. Ltd  
Rea Vipingo Plantations Ltd  
Sasini Ltd  
Williamson Tea Kenya Ltd

#### **COMMERCIAL AND SERVICES**

Express Ltd  
Kenya Airways Ltd  
Nation Media Group Ltd  
Standard Group Ltd  
TPS Eastern Africa (Serena) Ltd  
Scangroup Ltd  
Uchumi Supermarket Ltd  
Hutchings Biemer Ltd

#### **TELECOMMUNICATION AND TECHNOLOGY**

Access Kenya Group Ltd  
Safaricom Ltd

#### **AUTOMOBILES AND ACCESSORIES**

Car and General (K) Ltd  
CMC Holdings Ltd  
Sameer Africa Ltd  
Marshalls (E.A.) Ltd

#### **BANKING**

Barclays Bank Ltd  
CFC Stanbic Holdings Ltd  
Diamond Trust Bank Kenya Ltd  
Housing Finance Co Ltd  
**Kenya Commercial Bank Ltd**  
National Bank of Kenya Ltd  
NIC Bank Ltd  
Standard Chartered Bank Ltd  
Equity Bank Ltd  
The Co-operative Bank of Kenya Ltd

#### **INSURANCE**

Jubilee Holdings Ltd

Pan Africa Insurance Holdings Ltd  
Kenya Re-Insurance Corporation Ltd  
CFC Insurance Holdings  
British-American Investments Company (Kenya) Ltd

**INVESTMENT**

City Trust Ltd  
Olympia Capital Holdings Ltd  
Centum Investment Co Ltd  
Trans-Century Ltd

**MANUFACTURING AND ALLIED**

B.O.C Kenya Ltd  
British American Tobacco Kenya Ltd  
Carbacid Investments Ltd  
East African Breweries Ltd  
Mumias Sugar Co. Ltd  
Unga Group Ltd  
Eveready East Africa Ltd  
Kenya Orchards Ltd  
A.Baumann CO Ltd

**CONSTRUCTION AND ALLIED**

Athi River Mining Ltd  
Bamburi Cement Ltd  
Crown Berger Ltd  
E.A.Cables Ltd  
E.A.Portland Cement Ltd

**ENERGY AND PETROLEUM**

KenolKobil Ltd  
Total Kenya Ltd  
KenGen Ltd

Kenya Power & Lighting Co Ltd

Source: NSE Website ([www.nse.co.ke](http://www.nse.co.ke))

## **APPENDIX II: Companies that were sampled in this study.**

### **AGRICULTURAL**

Kakuzi Ltd

Sasini Ltd

### **COMMERCIAL AND SERVICES**

Kenya Airways Ltd

Nation Media Group Ltd

TPS Eastern Africa (Serena) Ltd

Scangroup Ltd

### **TELECOMMUNICATION AND TECHNOLOGY**

AccessKenya Group Ltd

Safaricom Ltd

### **AUTOMOBILES AND ACCESSORIES**

CMC Holdings Ltd

Sameer Africa Ltd

### **BANKING**

Barclays Bank Ltd

CFC Stanbic Holdings Ltd

Diamond Trust Bank Kenya Ltd

Housing Finance Co Ltd

Kenya Commercial Bank Ltd

National Bank of Kenya Ltd

NIC Bank Ltd

Standard Chartered Bank Ltd

Equity Bank Ltd

The Co-operative Bank of Kenya Ltd

### **INSURANCE**

Jubilee Holdings Ltd

Kenya Re-Insurance Corporation Ltd

### **INVESTMENT**

Centum Investment Co Ltd

### **MANUFACTURING AND ALLIED**

East African Breweries Ltd

Mumias Sugar Co. Ltd

Unga Group Ltd

Eveready East Africa Ltd

### **CONSTRUCTION AND ALLIED**

Athi River Mining Ltd

Bamburi Cement Ltd

Crown Berger Ltd

EA.Cables Ltd

**ENERGY AND PETROLEUM**

**KenoIKobil Ltd**

**Total Kenya Ltd**

**KenGen Ltd**

**Kenya Power & Lighting Co Ltd**

*Source: NSE Website ([www.nse.co](http://www.nse.co)).*

### APPENDIX III: STOCK PRICE MOVEMENT AND RETURNS

Date	KAKI'ZI		SASINI		KENYA AIRWAYS		NATION MEDIA GRP		NASI INDEX	
	Price	Return	Price	Return	Price	Return	Price	Return	Price	Return
-6	47.25	38.97%	8.75	7.36%	49.5	-1.00%	124	5.08%	79.18	1.32%
-5	79	67.20%	14.4	64.57%	60	21.21%	138	11.29%	84.43	6.63%
-4	75	-5.06%	14.45	0.35%	56.5	-5.83%	144	4.35%	90.31	6.96%
-3	74	-1.33%	13.45	-6.92%	55.5	-1.77%	141	-2.08%	91.86	1.72%
-.2	78	5.41%	14.05	4.46%	46.75	-15.77%	140	-0.71%	95	3.42%
-1	82	5.13%	14.2	1.07%	46.75	0.00%	142	1.43%	97.74	2.88%
0	83	1.22%	13.25	-6.69%	47	0.53%	158	11.27%	95.93	-1.85%
1	84	1.20%	13.3	0.38%	45.75	-2.66%	167	5.70%	98.92	3.12%
2	87.5	4.17%	14.6	9.77%	44.75	-2.19%	164	-1.80%	102.36	3.48%
3	82	-6.29%	12.75	-12.67%	46	2.79%	159	-3.05%	98.01	-4.25%
4	81.5	-0.61%	13.05	2.35%	46	0.00%	167	5.03%	97.82	-0.19%
5	81	-0.61%	12.9	-1.15%	45.75	-0.54%	171	2.40%	99.02	1.23%
6	79	-2.47%	11.55	-10.47%	39.5	-13.66%	173	1.17%	96.66	-2.38%

Date	TPS		SCANGROIP		ACCESS KENYA		SAFARICOM		NASI INDEX	
	Price	Return	Price	Return	Price	Return	Price	Return	Price	Return
-6	47	-1.57%	26.75	2.88%	20.75	-5.68%	5.4	2.86%	79.18	1.32%
i	63.5	35.11%	27.25	1.87%	20.25	-2.41%	5.55	2.78%	84.43	6.63%
1 -4	64	0.79%	27.25	0.00%	19.7	-2.72%	5.8	4.50%	90.31	6.96%
-3	60	-6.25%	33	21.10%	17.4	-11.68%	5.55	-4.31%	91.86	1.72%
-.2	56.5	-5.83%	39.75	20.45%	20.25	16.38%	5.8	4.50%	95	3.42%
-1	58	2.65%	36.25	-8.81%	19.9	-1.73%	5.85	0.86%	97.74	2.88%
0	57	-1.72%	54	48.97%	17.35	-12.81%	4.85	-17.09%	95.93	-1.85%
1	61	7.02%	62	14.81%	18.65	7.49%	4.45	-8.25%	98.92	3.12%
2	69.5	13.93%	68	9.68%	17.3	-7.24%	4.85	8.99%	102.36	3.48%
3	68	-2.16%	56.5	-16.91%	16	-7.51%	4.5	-7.22%	98.01	-4.25%
4	68.5	0.74%	61.5	8.85%	13.5	-15.63%	4.7	4.44%	97.82	-0.19%
5	65	-5.11%	62.5	1.63%	13.55	0.37%	4.45	-5.32%	99.02	1.23%
6	64	-1.54%	58	-7.20%	9.7	-28.41%	4	-10.11%	96.66	-2.38%

Date	CMC		SAMEER		BARCLAYS		CFC		NASI INDEX	
	Price	Return	Price	Return	Price	Return	Price	Return	Price	Return
-6	10.4	-10.34%	6.55	13.91%	50.5	2.54%	44.25	-1.67%	79.18	1.32%
-5	12	15.38%	9.5	45.04%	51	0.99%	40	-9.60%	84.43	6.63%
-4	13.5	12.50%	9.65	1.58%	57.5	12.75%	50	25.00%	90.31	6.96%
-3	13.05	-3.33%	8.2	-15.03%	59	2.61%	68	36.00%	91.86	1.72%
-.2	12.7	-2.68%	8.85	7.93%	61.5	4.24%	74	8.82%	95	3.42%
-1	12.4	-2.36%	8.65	-2.26%	66	7.32%	84.5	14.19%	97.74	2.88%
0	13	4.84%	8.95	3.47%	65.5	-0.76%	87	2.96%	95.93	-1.85%
1	12.95	-0.38%	8.7	-3.33%	67.5	3.05%	88.5	1.72%	98.92	3.12%
2	13.1	1.16%	8	-8.05%	67	-0.74%	88.5	0.00%	102.36	3.48%
j	11.95	-8.78%	5.95	-25.63%	61.5	-8.21%	80.5	-9.04%	98.01	-4.25%
4	12.25	2.51%	7.7	29.41%	62.5	1.63%	75.5	-6.21%	97.82	-0.19%
5	12.05	-1.63%	6.4	-16.88%	63	0.80%	80.5	6.62%	99.02	1.23%
6	9.9	-17.84%	6.05	-5.47%	69	9.52%	79	-1.86%	96.66	-2.38%



DTB			HFCK		KCB		BK		NASI INDEX	
Date	Price	Return	Price	Return	Price	Return	Price	Return	Price	Return
-6	71.5	0.00%	17.55	-2.77%	20.5	-6.82%	39.75	1.92%	79.18	1.32%
-5	79	10.49%	17	-3.13%	22	7.32%	57.5	44.65%	84.43	6.63%
-4	85.5	8.23%	23.5	38.24%	23	4.55%	43.75	-23.91%	90.31	6.96%
-3	84.5	-1.17%	20.5	-12.77%	20.25	-11.96%	40.25	-8.00%	91.86	1.72%
• 2	89.5	5.92%	21	2.44%	18.6	-8.15%	39.5	-1.86%	95	3.42%
• 1	%	7.26%	23.75	13.10%	19	2.15%	39	-1.27%	97.74	2.88%
o	108	12.50%	24.25	2.11%	19	0.00%	38.5	-1.28%	95.93	-1.85%
1	109	0.93%	26.75	10.31%	20.75	9.21%	39	1.30%	98.92	3.12%
2	134	22.94%	28.75	7.48%	22.5	8.43%	39.75	1.92%	102.36	3.48%
3	131	-2.24%	25.25	-12.17%	21.25	-5.56%	38.5	-3.14%	98.01	-4.25%
4	135	3.05%	26.5	4.95%	21.75	2.35%	38.75	0.65%	97.82	-0.19%
5	145	7.41%	27.25	2.83%	23	5.75%	45.5	17.42%	99.02	1.23%
6	144	-0.69%	29.25	7.34%	23.25	1.09%	47	3.30%	96.66	-2.38%

NIC			STANCHART		EQUITY		COOP BANK		NASI INDEX	
Date	Price	Return	Price	Return	Price	Return	Price	Return	Price	Return
-6	36	2.86%	178	5.33%	15.6	-2.19%	9.75	0.52%	79.18	1.32%
-5	32.5	-9.72%	189	6.18%	15.8	1.28%	10	2.56%	84.43	6.63%
-4	38.75	19.23%	199	5.29%	18.55	17.41%	11.85	18.50%	90.31	6.96%
-3	36.75	-5.16%	216	8.54%	22.5	21.29%	12.65	6.75%	91.86	1.72%
• 2	39.5	7.48%	222	2.78%	24	6.67%	15	18.58%	95	3.42%
-1	39.5	0.00%	254	14.41%	23.75	-1.04%	15	0.00%	97.74	2.88%
o	46.25	17.09%	251	-1.18%	25	5.26%	16.5	10.00%	95.93	-1.85%
1	45.5	-1.62%	275	9.56%	26.75	7.00%	18.3	10.91%	98.92	3.12%
2	49.25	8.24%	259	-5.82%	26.25	-1.87%	19.9	8.74%	102.36	3.48%
3	48.25	-2.03%	270	4.25%	25.5	-2.86%	19	-4.52%	98.01	-4.25%
4	46	-4.66%	258	-4.44%	26.75	4.90%	19	0.00%	97.82	-0.19%
5	50	8.70%	271	5.04%	29	8.41%	20.25	6.58%	99.02	1.23%
6	50	0.00%	279	2.95%	28.5	-1.72%	20.25	0.00%	96.66	-2.38%

J1B11.EE			KENYA RE		CENTUM		EABI.		NASI INDEX	
DattJ	Price	Return	Price	Return	Price	Return	Price	Return	Price	Return
-6	135	-2.88%	12.8	-4.83%	12.5	-6.37%	152	1.33%	79.18	1.32%
-5	171	26.67%	13.5	5.47%	15.6	24.80%	162	6.58%	84.43	6.63%
-4	180	5.26%	13.25	-1.85%	17.85	14.42%	170	4.94%	90.31	6.96%
-3	173	-3.89%	11.9	-10.19%	18.7	4.76%	177	4.12%	91.86	1.72%
• 2	170	-1.73%	12.1	1.68%	22.25	18.98%	181	2.26%	95	3.42%
-1	174	2.35%	12.4	2.48%	22	-1.12%	182	0.55%	97.74	2.88%
o	197	13.22%	12.2	-1.61%	23	4.55%	179	-1.65%	95.93	-1.85%
1	189	-4.06%	11.95	-2.05%	25.25	9.78%	188	5.03%	98.92	3.12%
2	195	3.17%	12	0.42%	24	-4.95%	212	12.77%	102.36	3.48%
3	189	-3.08%	11.8	-1.67%	24.25	1.04%	216	1.89%	98.01	-4.25%
4	184	-2.65%	11.05	-6.36%	23	-5.15%	201	-6.94%	97.82	-0.19%
5	195	5.98%	11.4	3.17%	24	4.35%	184	-8.46%	99.02	1.23%
6	187	-4.10%	10.55	-7.46%	22	-8.33%	182	-1.09%	96.66	-2.38%

Date	MI MIAS		I NGA		EVEREADY		ATHIRIVER		NASI INDEX	
	Price	Return	Price	Return	Price	Return	Price	Return	Price	Return
-6	9.95	11.17%	9.7	6.59%	3.55	-5.33%	104	0.00%	79.18	1.32%
-5	10.5	5.53%	10.5	8.25%	4.7	32.39%	114	9.62%	84.43	6.63%
-4	13.05	24.29%	11	4.76%	4.85	3.19%	115	0.88%	90.31	6.96%
-3	12.8	-1.92%	11.85	7.73%	4.35	-10.31%	128	11.30%	91.86	1.72%
-.2	12.85	0.39%	12.25	3.38%	4	-8.05%	140	9.38%	95	3.42%
-1	13.65	6.23%	12.45	1.63%	3.85	-3.75%	155	10.71%	97.74	2.88%
0	11.75	-13.92%	12.7	2.01%	4	3.90%	162	4.52%	95.93	-1.85%
1	12.2	3.83%	12.7	0.00%	3.8	-5.00%	183	12.96%	98.92	3.12%
2	10.8	-11.48%	12	-5.51%	3.6	-5.26%	176	-3.83%	102.36	3.48%
3	9.55	-11.57%	10.95	-8.75%	2.5	-30.56%	170	-3.41%	98.01	-4.25%
	9.7	1.57%	11	0.46%	3	20.00%	183	7.65%	97.82	-0.19%
5	8.9	-8.25%	11	0.00%	2.8	-6.67%	189	3.28%	99.02	1.23%
6	8.05	-9.55%	10.65	-3.18%	2.5	-10.71%	178	-5.82%	96.66	-2.38%

Date	BAMBI'RI		CROWN BERGER		EA CABLES		KENOLKOBIL		NASI INDEX	
	Price	Return	Price	Return	Price	Return	Price	Return	Price	Return
-6	170	1.19%	27	5.88%	22.5	-3.23%	63.5	4.10%	79.18	1.32%
-5	187	10.00%	28	3.70%	22	-2.22%	77	21.26%	84.43	6.63%
-4	189	1.07%	38	35.71%	22.25	1.14%	84	9.09%	90.31	6.96%
-j	200	5.82%	33.25	-12.50%	19.35	-13.03%	100	19.05%	91.86	1.72%
_2	200	0.00%	31.75	-4.51%	20.25	4.65%	91.5	-8.50%	95	3.42%
-1	200	0.00%	35.75	12.60%	19.25	-4.94%	101	10.38%	97.74	2.88%
0	201	0.50%	37	3.50%	18.85	-2.08%	96	-4.95%	95.93	-1.85%
1	212	5.47%	38	2.70%	18.8	-0.27%	99.5	3.65%	98.92	3.12%
2	206	-2.83%	37	-2.63%	18.1	-3.72%	107.5	8.04%	102.36	3.48%
3	1%	-4.85%	32	-13.51%	15.4	-14.92%	100	-6.98%	98.01	-4.25%
4	187	-4.59%	36	12.50%	16.25	5.52%	100	0.00%	97.82	-0.19%
5	201	7.49%	34.5	-4.17%	16	-1.54%	100	0.00%	99.02	1.23%
6	196	-2.49%	33	-4.35%	18.95	18.44%	93.5	-6.50%	96.66	-2.38%

Date	TOTAL KENYA		KENGEN		KPLC		NASI INDEX	
	Price	Return	Price	Return	Price	Return	Price	Return
-6	31	4.20%	13.4	-7.27%	161	8.05%	79.18	1.32%
-5	30.25	-2.42%	15	11.94%	170	5.59%	84.43	6.63%
-4	30	-0.83%	15.8	5.33%	180	5.88%	90.31	6.96%
-3	29.75	-0.83%	16.95	7.28%	200	11.11%	91.86	1.72%
	28.5	-4.20%	17.1	0.88%	200	0.00%	95	3.42%
-1	30.5	7.02%	17.45	2.05%	196	-2.00%	97.74	2.88%
0	29.5	-3.28%	17.45	0.00%	206	5.10%	95.93	-1.85%
1	31.75	7.63%	17.65	1.15%	236	14.56%	98.92	3.12%
2	30.25	-4.72%	17.95	1.70%	225	-4.66%	102.36	3.48%
3	29	-4.13%	16.45	-8.36%	225	0.00%	98.01	-4.25%
4	29	0.00%	17	3.34%	240	6.67%	97.82	-0.19%
5	28.75	-0.86%	16.6	-2.35%	240	0.00%	99.02	1.23%
6	28	-2.61%	15.2	-8.43%	220	-8.33%	96.66	-2.38%

**APPENDIX IV: PRICE MOVEMENT AND RETURNS PER SEGMENT.**

	<b>AGRICULTURAL</b>	<b>COMMERCIAL</b>	<b>TELECOM AND TECH</b>	<b>AUTO AND ACC</b>	<b>NASI INDEX</b>
<b>Date</b>	<b>AY. Return</b>	<b>AV. Return</b>	<b>AY. Return</b>	<b>AY. Return</b>	<b>Return</b>
-6	23.17%	1.35%	-1.41%	1.78%	1.32%
-5	65.88%	17.37%	0.18%	30.21%	6.63%
-4	-2.36%	-0.17%	0.89%	7.04%	6.%%
-3	-4.13%	2.75%	-7.99%	-9.18%	1.72%
-2	4.93%	-0.46%	10.44%	2.62%	3.42%
-1	3.10%	-1.18%	-0.43%	-2.31%	2.88%
0	-2.74%	14.76%	-14.95%	4.15%	-1.85%
1	0.79%	6.22%	-0.38%	-1.86%	3.12%
2	6.97%	4.91%	0.88%	-3.44%	3.48%
3	-9.48%	-4.83%	-7.37%	-17.20%	-4.25%
4	0.87%	3.65%	-5.59%	15.%%	-0.19%
5	-0.88%	-0.41%	-2.47%	-9.26%	1.23%
6	-6.47%	-5.31%	-19.26%	-11.66%	-2.38%

	<b>BANKING</b>	<b>INSURANCE</b>	<b>INVESTMENT</b>	<b>MANUFAND ALLIED</b>	<b>NASI INDEX</b>
<b>Date</b>	<b>AY. Return</b>	<b>AV. Return</b>	<b>AV. Return</b>	<b>AY. Return</b>	<b>Return</b>
-6	-0.03%	-3.86%	-6.37%	3.44%	1.32%
-5	5.10%	16.07%	24.80%	13.19%	6.63%
-4	12.53%	1.71%	14.42%	9.29%	6.96%
-3	3.61%	-7.04%	4.76%	-0.10%	1.72%
-2	4.69%	-0.03%	18.98%	-0.50%	3.42%
-1	5.61%	2.42%	-1.12%	1.17%	2.88%
0	4.67%	5.80%	4.55%	-2.42%	-1.85%
1	5.24%	-3.06%	9.78%	0.00%	3.12%
2	4.93%	1.80%	-4.95%	-2.37%	3.48%
3	-4.55%	-2.37%	1.04%	-12.25%	-4.25%
4	0.22%	-4.50%	-5.15%	3.77%	-0.19%
5	6.96%	4.57%	4.35%	-5.84%	1.23%
6	1.99%	-5.78%	-8.33%	-6.13%	-2.38%

	<b>CONSTR AND ALLIED</b>
<b>Date</b>	<b>AV. Return</b>
-6	0.96%
-5	5.27%
-4	9.70%
-3	-2.10%
-2	2.38%
-1	4.59%
0	1.61%
1	5.22%
2	-3.25%
3	-9.17%
4	5.27%
5	1.27%
6	1.45%

<b>ENERGY AND PETROLEUM</b>	<b>ALL SHARES AVERAGE</b>	<b>NASI INDEX</b>
<b>AV. Return</b>	<b>AV. Return</b>	<b>Return</b>
2.27%	2.13%	1.32%
9.09%	18.72%	6.63%
4.87%	5.79%	6.00%
9.15%	-1.03%	1.72%
-2.95%	4.01%	3.42%
4.36%	1.62%	2.88%
-0.78%	1.47%	-1.85%
6.75%	2.97%	3.12%
0.09%	0.56%	3.48%
-4.87%	-7.10%	-4.25%
2.50%	1.70%	-0.19%
-0.80%	-0.25%	1.23%
-6.60%	-6.60%	-2.38%

## APPENDIX V: SUMMARY OF STOCK BETA BY SEGMENT

S/n	Market Segments	Beta Factor	
		Before	After
1	Agriculture	6.716	2.053
2	Commercial and Services	1.573	1.321
3	Telecommunications and Technology	0.673	1.753
4	Automobiles and Accessories	5.149	1.743
5	Banking	1.052	1.214
6	Insurance	2.569	0.930
7	Investment	3.064	-0.027
8	Manufacturing and Allied	2.457	1.120
9	Construction and Allied	1.570	0.627
10	Energy and Petroleum	0.291	0.847