

This work is licensed under a
Creative Commons Attribution-NonCommercial-
NoDerivs 3.0 Licence.

To view a copy of the licence please see:
<http://creativecommons.org/licenses/by-nc-nd/3.0/>

SOIL AND WATER CONSERVATION IN KENYA

Proceedings of a Second National Workshop,
Nairobi, March 10 - 13, 1982

edited by

D.B. Thomas and W.M. Senga

Published by

Institute for Development Studies
and Faculty of Agriculture,
University of Nairobi
P.O. Box 30197, Nairobi.

This paper has protection under the Copyright Act,
Cap. 130 of the Laws of Kenya.

1983

TRIBUTE

Professor William M. Senga, one of the editors of these proceedings, died suddenly on June 7th, 1983, at the age of 47. At the time of his death, he was Director of the Institute for Development Studies and had completed almost all the arrangements for this publication.

Mr. Jim M. Nightingale, joint author of paper no. 18, died on February 26th, 1983, at the age of 73. As a farmer he had been active in efforts to improve the conservation of soil and water and to promote tree planting in dry areas. He was also a recognised authority on beekeeping in Kenya.

We would like to take this opportunity, on behalf of ourselves and our colleagues, to express our deep appreciation for the contribution made by Professor William Senga and by Mr. Jim Nightingale to this publication and to the Nation.

| | |
|--|---|
| Kabiru Kinyanjui Acting Director, Institute for Development Studies. | Donald B. Thomas Department of Agricultural Engineering, Faculty of Agriculture. |
|--|---|

ERRATA

Due to rearrangement of material, the following
page numbers have been deleted:
192, 193, 204, 205, 274, 275.

TABLE OF CONTENTS

| | <u>Page</u> |
|--|-------------|
| PREFACE | |
| ABBREVIATIONS | |
| OPENING ADDRESS | |
| <u>SECTION A. EROSION PROCESSES AND RATES</u> | |
| 1. Rainfall erosivity in Kenya - some preliminary conclusions by K.M. Rowntree | 1 |
| 2. The magnitude and sources of soil erosion in some humid and semiarid parts of Kenya and the significance of soil loss tolerance values in soil conservation in Kenya by R.G. Barber | 20 |
| 3. Erosion monitoring programme of the National Environmental Secretariat by L.A. Lewis | 47 |
| 4. The design and installation of runoff plot equipment for the National Dryland Research Station, Katumani, Machakos by L.G. Ulsaker | 50 |
| 5. Field experiments on soil erosion in Amboseli, Kajiado District by B. Aubry and E.K. Wahome | 65 |
| <u>SECTION B. EROSION AND LAND USE SURVEYS</u> | |
| 6. The role of soil surveys and land evaluation in assessing soil erosion hazard by F.N. Muchena | 79 |
| 7. A preliminary report on an evaluation and detailed mapping of the erosion susceptibility at Kaloleni, Kilifi District by C. Gachene and R.G. Barber | 87 |
| 8. A reconnaissance survey of erosion processes in Machakos District, Kenya by L.M. Reid. | 105 |
| 9. Application of low level aerial survey to studies of soil erosion by M. Norton-Griffiths | 123 |
| 10. Landsat data for resource analysis by B.N. Haack | 151 |
| 11. A case study of the application of Landsat data for soil and vegetation analysis in the Rift Valley west of Nairobi by L.A. Isawa | 161 |

| | <u>Page</u> |
|---|-------------|
| <u>SECTION C. POLICIES, PROGRAMMES AND TRAINING</u> | |
| 12. Soil and water conservation extension - the Kenya experience by S.N.J. Njoroge | 174 |
| 13. The role of the Permanent Presidential Commission on Soil Conservation and Afforestation in promoting soil and water conservation by G.K. Mburathi | 185 |
| 14. Strategies and constraints of planning soil and water management programmes on the catchment basis in Western Kenya by P.A.M. Misiko | 194 |
| 15. Practical Farmers' training in conservation by M.A. Zobisch | 206 |
| 16. Information for soil and water conservation by Mutuku Nzioki | 213 |
| <u>SECTION D. PHYSICAL PLANNING AND ECONOMIC APPRAISAL</u> | |
| 17. An integrated approach to land development and soil conservation in agricultural settlement projects - the Magarini experience by C.M. Adamson, I.R. Melville, G.T. Kariuki | 220 |
| 18. The counter-contour system of soil and water conservation and land drainage by J. Nightingale and G. Nightingale | 235 |
| 19. The design of artificial waterways for densely settled areas of steep land by D.B. Thomas | 241 |
| 20. Evaluation and economic appraisal for soil conservation in a pilot area by L. Hedfors | 257 |
| <u>SECTION E. WATER RESOURCES, CONSERVATION AND UTILISATION</u> | |
| 21. Water conservation activities in arid and semiarid zones of Kenya by M. Trojanov | 263 |
| 22. Athi River sediment yields and significance for water resource development by A.S. Wain | 274 |
| 23. Integral filter system for reservoirs of small earth dams by V. Werner | 294 |
| 24. The potential of runoff harvesting for crop production and range rehabilitation in semiarid Baringo by P.D. Smith and W.R.S. Critchley | 305 |

| | <u>Page</u> |
|--|-------------|
| 25. Use of microcatchments for tree planting in soil conservation for semi-arid areas by E.G.C. Barrow | 324 |

SECTION F. FOREST MANAGEMENT AND TILLAGE PRACTICES

| | |
|---|-----|
| 26. The effect of plant residues on water holding capacity of the soil in no tillage systems by R.W. Michieka | 333 |
| 27. The role of agroforestry in soil and water conservation by Amare Getahun | 338 |
| 28. Effects of forest management practises on soil and water conservation in Kenya forests by P.K.A. Konuche | 350 |
| 29. The problems of soil erosion and fertility maintenance in the tropics by S.K. Mutiso | 360 |
| 30. Zero/minimum tillage in the tropics - some comments and suggestions by P.A. Huxley | 370 |
| 31. Conservation tillage in semiarid areas of Kenya by G. Muchiri and F.N. Gichuki | 395 |
| QUESTIONS AND COMMENTS | 420 |
| FIELD VISIT TO MACHAKOS | 428 |
| FIELD VISIT TO MURANGA | 431 |
| CONCLUSIONS AND RECOMMENDATIONS | 437 |
| WORKSHOP PROGRAMME SUMMARY | 442 |
| LIST OF PARTICIPANTS | 443 |

P R E F A C E

The proper use of soil and water resources is basic to meeting the needs of Kenya's population which is not only expanding rapidly but also seeking a better standard of living. This volume reflects a growing interest among the scientific community in soil and water conservation as it contains more than twice as many papers as the proceedings of the first workshop on this subject held in 1977.

The papers presented here give some indication of the "state of the art" in Kenya at the present time and should prove a valuable source of information and ideas for those involved in extension, teaching and research. A broad range of topics are covered showing that conservation is part and parcel of proper land use and that conservation of water and conservation of soil must go hand in hand.

The papers have been grouped under six headings of which the first two are concerned mainly with surveying and measuring erosion processes. This type of study is important for assessing long term trends and making predictions about the consequences of changes in land use or conservation practice. The third section covers important aspects of Government policy and programmes and reviews the information sources that are available to research workers and planners. The fourth section is concerned with aspects of physical planning and economic appraisal and reflects some of the problems and possibilities of the large mechanised farm and the small labour intensive holding. The conservation and utilisation of water resources in semi-arid areas is the main topic of the fifth section and introduces the concept of water harvesting which is attracting increasing interest. The last section presents some aspects of the management of forest and cropland and examines the role of agroforestry in soil and water conservation.

After the formal presentation of papers, questions and comments were invited and participants were asked to record their remarks. We are grateful to Mr. R.G. Barber for compiling the material submitted and for help in many other ways.

The scientific approach to soil and water conservation in tropical areas with a high rural population, small farms and big variations in climate is still undergoing development. It is therefore important to keep policies and programmes under regular review and, where necessary, to adapt or modify current practices in the light of new information or experience. The establishment of a coordinating body to carry out such a function was one of the main recommendations arising out of the discussions which are summarised at the end of this publication under Conclusions and Recommendations.

We believe that these proceedings will be useful both by documenting what is known and by indicating areas where further research is needed. One aspect which is barely mentioned here, but deserves greater attention from research scientists, is the human factor in soil and water conservation. Conservation is only likely to be successful where the farmer understands what is needed and is able to carry it out. The farmer's own perceptions, abilities and constraints warrant much greater attention in future.

As a contribution to the workshop, the staff of the University Library at Kabete Campus under the direction of Mr. S. Durrani, Librarian, produced a bibliography on soil and water conservation in Kenya which should be invaluable to anyone writing a review or planning a research programme and wanting to know what has already been done. Further useful bibliographic material was provided by Mr. Mutuku Nzioki, Librarian, Egerton College, and it is intended that a comprehensive bibliography should be published in due course.

The success of the workshop, which was attended by more than 130 people, was due to the excellent cooperation between various organisations including the University of Nairobi, Egerton College, Ministry of Agriculture, Ministry of Water Development, National Environment and Human Settlement Secretariat, Kenya Agricultural Research Institute, Permanent Presidential Commission on Soil Conservation and Afforestation and several others.

We would like to thank the following people for assistance in planning and organising the workshop and/or reviewing papers:-

Mr. R.G. Barber, Prof. B.L. Bondurant, Mr. S. Durrani,* Prof. R. Ford, Mr. F.N. Gichuki, Prof. C.M. Jacob, Mr. D. Kamweti, Dr. S.O. Keya,* Mr. F.W. Mbote,* Mr. S.G. Mburu,* Dr. J.P. Mbuvi, Dr. R.W. Michieka,* Dr. P.A.M. Misiko, Mr. F.N. Muchena, Mr. J.M. Mureithi, Mr. S.K. Muriuki,* Dr. D.N. Ngugi,* Mr. S.N.J. Njoroge, Mr. S.F.O. Owido,* Dr. F. Owino,* Mr. P.D. Smith, Mr. L. Ulsaker,* Dr. F. Wangati.

(*Members of the Organising Committee)

We are especially grateful to Prof. J.M. Mungai, Vice Chancellor, University of Nairobi for giving the closing address in which he emphasised the need for academics to be involved with national development at a practical level; and to Dr. D.N. Ngugi who, as Dean of the Faculty of Agriculture and Chairman of the Organising Committee, gave continuous support and encouragement.

We would also like to thank the Director of the National Environment and Human Settlement Secretariat and the Director of the Kenya Agricultural Research Institute for making a contribution from USAID budgeted funds to assist with publication.

Two field trips were arranged during the workshop so that participants could see the progress being made and the problems being encountered in two very different districts, Machakos and Muranga, and we would like to thank Messrs J.M. Gitau, J.N. Mbuthia, S.K. Ndaba, M.K. arap Too, M. Zovisch and V. Warner for helping to arrange these trips and explaining the projects and programmes visited.

Special thanks go to Mrs. Esther A. Onim, Secretary to the Department of Agricultural Engineering, for her highly efficient secretarial help in connection with the workshop over a period of about two years and to Mrs. I. Ulsaker for compiling the original list of participants.

Last but not least, the staff of the Institute for Development Studies must be thanked and in particular Mr. Samson E. Otieno, Mrs. Agnes M. Ng'ang'a, Mrs. Margaret G. Karimi and Mrs. Prisilla Mutisya who typed the final manuscript. Mrs. Justina Muchura, IDS Publications Editor, assisted with proof reading and supervised the various stages of this publication.

D. B. Thomas
Senior Lecturer, Department of Agricultural
Engineering and Workshop Organising Secretary.

W. M. Senga
Director, Institute for Development Studies.

Nairobi, Kenya
March, 1983.

ABBREVIATIONS

| | |
|----------------|--|
| A.A.O. | Assistant Agricultural Officer |
| A.I.D. | Agency for International Development (of USA) |
| A.S.A.L. | Arid & Semiarid Lands |
| A.S.A.R.C. | Agricultural Sciences Advisory Research Committee (of NCST) |
| B.P.S.A.A.P. | Baringo Pilot Semiarid Areas Project |
| C.I.D.A. | Canadian International Development Agency |
| D.A.N.I.D.A. | Danish International Development Agency |
| D.A.O. | District Agricultural Officer |
| D.L.O. | District Livestock Officer |
| D.L.R.D.O. | District Land Resource Development Officer |
| D.O. | District Officer |
| E.A.A.F.R.O. | East African Agricultural & Forestry Research Organisation (now KARI) |
| E.M.I. | Embu/Meru/Isiolo |
| F.A.O. | Food & Agriculture Organisation of the United Nations |
| F.T.C. | Farmers' Training Centre |
| G.K. or GoK | Government of Kenya |
| I.C.R.A.F. | International Centre for Research in Agroforestry |
| I.C.R.I.S.A.T. | International Centre for Research in Semiarid Tropics |
| I.D.S. | Institute for Development Studies |
| I.I.T.A. | International Institute of Tropical Agriculture |
| K.A.R.I. | Kenya Agricultural Research Institute |
| K.R.E.M.U. | Kenya Rangeland Ecological Monitoring Unit |
| K.S.S. | Kenya Soil Survey |
| K.V.D.A. | Kerio Valley Development Authority |
| L.B.D.A. | Lake Basin Development Authority |
| M.I.D.P. | Machakos Integrated Development Programme |
| M.O.A. | Ministry of Agriculture |
| M.O.W.D. | Ministry of Water Development |
| N.A.L. | National Agricultural Laboratories |
| N.C.S.T. | National Council of Science and Technology |
| N.D.F.R.P. | National Dryland Farming Research Project |

| | |
|------------|---|
| N.E.H.S.S. | National Environmental & Human Settlement Secretariat (formerly National Environment Secretariat) |
| O.D.A. | Overseas Development Administration (of U.K.) |
| S.C.S. | Soil Conservation Service (of USA) |
| S.I.D.A. | Swedish International Development Agency |
| T.A. | Technical Assistant |
| T.A.R.D.A. | Tana and Athi Rivers Development Authority (formerly Tana River Development Authority) |
| T.P.I.P. | Training Project in Pedology (Netherlands) |
| U.N.D.P. | United Nations Development Programme |
| U.N.E.P. | United Nations Environmental Programme |
| U.S.A.I.D. | United States Agency for International Development |
| U.S.L.E. | Universal Soil Loss Equation |
| U.S.S.C.S. | United States Soil Conservation Service |

OPENING ADDRESS

By

Dr. D.N. NGUGI
Dean, Faculty of Agriculture
University of Nairobi.

Ladies and Gentlemen:

First let me start by welcoming all of you to the Faculty of Agriculture. For those of you for whom this is your first time to visit the Faculty, I wish to extend a very warm welcome.

The first time that a Soil and Water Conservation Workshop was held in Kenya was in September, 1977. At that workshop, which was held in this same room, various papers on soil and water conservation were presented and discussed. At that workshop it was agreed and resolved by the participants that there was need for similar workshops to be held on a regular basis in order for the participants to keep abreast of research and other development activities in Soil and Water Conservation. Hence the convening of this second workshop. We in the Faculty feel particularly honoured by the fact that for a second time the organisers have chosen our Faculty to be the venue for the workshop.

As in the first workshop, the objectives of this workshop, remain the same, that is:-

- (i) To bring together researchers, teachers, extension officers and others who are concerned with the problems of soil and water conservation.
- (ii) To exchange information and discuss problems in assessing needs and in planning, implementing and evaluating conservation systems.
- (iii) To identify priorities for future work and to seek ways of increasing the effectiveness of research, teaching and extension.

The workshop is a joint exercise planned and organised by staff from the Faculty of Agriculture, Ministry of Agriculture, Kenya Agricultural Research Institute, Egerton College and other bodies.

As I have just said, the last forum of this kind took place at Kabete in September, 1977. Since that time there have been many changes and developments which emphasise the need once again to bring together all those who are concerned with soil and water conservation. The developments include:-

- (a) the establishment of projects involving soil and water conservation in Machakos, Kitui, Baringo, Embu/Meru/Isiolo, and elsewhere.
- (b) the growth of the National Environmental Secretariat, reorganisation of Kenya Agriculture Research Institute (K.A.R.I.) and the establishment of the Permanent Presidential Commission on Soil Conservation and Afforestation.
- (c) the development of an educational programme producing a small but growing number of people with specialisation in soil and water conservation.

Examples include the following:

- (i) B.Sc. Agric. Engineering Programme at the University of Nairobi with an Option in Soil and Water Engineering
- (ii) Postgraduate Diploma Programme in the Faculty of Agriculture with Options in Soil Conservation and Irrigation
- (iii) Diploma in Agricultural Engineering at Egerton College with an option in Soil and Water Engineering.

Coordination among those involved in all these activities is needed and the workshop will help to facilitate this.

The specialist in Soil and Water Conservation needs to be able to integrate knowledge from a wide range of disciplines such as Soil Science, Hydrology, Agronomy, Ecology and Engineering. Furthermore he needs an understanding of the social and economic constraints within which the farmer operates. Many of the problems faced are difficult to solve and we need to recognise areas of ignorance and uncertainty and to investigate situations where the measures tried have proved unsatisfactory and the proper solutions are not yet known. In particular we need to take more account of variations in soils, slopes, and climate and farming practices and to understand how these affect the conservation measures we recommend. We also need to see conservation as part of the farming system designed to preserve, improve and utilize the land.

It is often argued that research is not needed, and that implementation is the main weakness in conserving soil and water. However experience has shown that some measures implemented have only lasted a short time. Undue haste has sometimes aggravated the problems needing to be solved and has occasionally led to loss of confidence among the farmers affected. Considering the size of the problems it is surprising that so little research has been done. It must be recognised that research is usually slow and costly but much can be gained by careful documentation of work which is done and evaluation of successes and failures.

The University of Nairobi has already made a contribution in research on problems of soil and water conservation. Several Faculties and Departments have been involved and more work can be done if financial support is forthcoming. A proposal for a Soil and Water Conservation Research Unit has been included in the University Development Plans and could be implemented if a donor agency can be found to support it.

Both staff and students have been involved in research and the project reports of the postgraduate diploma students are helping to document the present situation in the country with respect to soil and water conservation. The improvement in library documentation services in the University, Egerton College and the Ministry of Agriculture is making available a wealth of material from inside and outside Kenya which is relevant to the problems we are confronting.

In view of the changes and developments taking place in the country and the small but increasing supply of specialist manpower it is necessary to change the organisational framework for handling soil and water conservation. We welcome the recent amalgamation of soil and water activities in one division of the Ministry of Agriculture and hope that this division will be strengthened by additional staff with relevant qualifications and experience who can speed up the planning and implementation of measures to control soil and water losses. In view of the range of projects and organisations involved in soil and water conservation there is a need for a strong team of specialists in the Ministry of Agriculture who can provide the direction and coordination required and long term continuity which is often lacking in crash programmes and short term projects. In this connection the career prospects must be satisfactory in order to attract staff of suitable calibre.

Conservation of water is as important as conservation of soil. The potential for irrigation will be limited by the rapidly increasing demands on water supplies for domestic and industrial use. Conservation of rainfall where it falls can make a major contribution to increasing food supplies in areas of low and unreliable rainfall. The workshop will pay particular attention to the collection, storage and utilisation of runoff in arid and semi-arid areas.

The proceedings of the workshop will be published in due course and the material will then be available to a much wider audience both in Kenya and elsewhere. It will also provide some baseline information from which progress can be seen in the years ahead. On behalf of the organisers, I wish to express deep appreciation to several organisations which have offered to assist in the publication of the proceedings.

Lastly, let me once again welcome you and wish everybody very fruitful deliberations in the workshop.

Conservation of water is as important as conservation of soil. The potential for irrigation will be limited by the rapidly increasing demands on water supplies for domestic and industrial use. Conservation of rainfall where it falls can make a major contribution to increased water supplies in areas of low and unreliable rainfall. The workshop will pay particular attention to the collection, storage and utilisation of runoff in arid and semi-arid areas.

RAINFALL EROSIVITY IN KENYA-SOME PRELIMINARY
CONSIDERATIONS

By

K. M. Rowntree
Department of Geography
Kenyatta University College

INTRODUCTION

The relationship between rainfall characteristics and soil erosion, or its surrogate catchment sediment yield, has been the subject of many studies throughout the world. Rainfall is known to have two important effects on erosion. On the one hand the rainfall provides the energy that seals the soil surface and detaches soil particles, and is also the source of overland flow which further detaches and transports the particles. On the other hand rainfall provides the moisture that supports a vegetation cover. This in its turn both dissipates the energy of rainfall and overland flow and encourages high infiltration rates. The early study by Langbein and Schumm (1958) illustrated this relationship well; a later study by Douglass (1967) substantiated their results. Both pieces of work showed that maximum sediment yields occurred in areas with an annual rainfall-evaporation balance of between 30 and 50 millimetres. Lower rainfall amounts lead to a decrease in the available energy for erosion whereas higher rainfall supports a denser vegetation cover which protects the soil from the erosive effects of the rainfall.

The seasonal variation of rainfall and its relationship to vegetation cover is also of significance, especially in tropical areas which experience a marked contrast between wet and dry seasons. This was taken into account by Fournier (1962) who found that catchment sediment yields were closely related to the index p^2/P where P is the mean annual rainfall and p is the maximum mean monthly rainfall. As pointed out by Morgan (1979 p. 27), this is an index of the concentration of rainfall into one month. It thus gives a crude index of rainfall intensity and also indicates the seasonality of rainfall and the

CONSIDERATIONS

length of a dry season during which the plant cover decays. The p^2/P index thus combines factors of rainfall energy with those of ground cover and gives an indication of the relative erosion risk. A study by Morgan (1979, p. 76) showed that in Malaysia p^2/P was significantly correlated to drainage texture, a measure of gully density. Gullies are characteristic of areas with strongly seasonal rainfall and high rates of surface runoff.

Few studies have explicitly followed up this relationship between rainfall and vegetation cover in the assessment of erosion risk. More usually, research has been confined to studies of rainfall energy or erosivity alone without regard to the vegetation factor. A number of rainfall erosivity maps have been produced for different parts of the world. The first such map was compiled by Wischmeier and Smith (1965) for the United States; other examples are that for Zimbabwe by Stocking and Ellwell (1976), for East Africa by Moore (1978) and Malaysia by Morgan (1979, p. 75). The papers by Stocking and Ellwell and by Moore both present a seasonal analysis of erosivity and stress the significance of concomitant changes in the vegetation cover, but do not go further. It is the aim of this paper to outline a programme for assessing the regional variations in erosion risk in Kenya as related to rainfall erosivity and vegetation cover. Two approaches are followed. Firstly a map of p^2/P values is presented, following earlier work by Fournier and Morgan. This provides a reconnaissance map of erosion risk based on a minimum of analysis. Secondly an analysis of rainfall data is presented for Katumani Research Station, Machakos, showing both the seasonal distribution of storm erosivity and the changes in the estimated soil moisture deficit. This latter value is used here as an indicator of plant vigour and hence ground vegetation cover. From the results of this detailed analysis for one station a proposal is made for a regional study of erosion risk.

the maximum near monthly rainfall. As pointed out by Morgan (1979, p. 75), this is an index of the concentration of rainfall into one month. It thus gives a crude index of rainfall intensity and also indicates the seasonality of rainfall and the

AN ASSESSMENT OF EROSION RISK FOR KENYA USING p^2/P VALUES

Monthly rainfall data for 111 stations were available from the publication Climatological Statistics for East Africa, Part I, Kenya, published by the East African Meteorological Department, Nairobi, 1975. Although concentrated in western and central Kenya these data provide a fair cover for the whole country. From the 111 points, areas with similar values for p^2/P were delineated. It was apparent that breaks in the p^2/P values were associated with topographic features so these were used to locate the boundaries between areas. The final map is presented in Figure 1.

A wide range in p^2/P values occur in Kenya; a minimum value of 13 was found in Lodwar in Northern Kenya and a maximum of 123 for Lamu on the coast. Values are related to both total rainfall and to seasonality so that they tend to be highest to the east of the Rift Valley where the rainfall is sharply bimodal.

Morgan (1979) distinguishes high risk areas as those having a p^2/P value exceeding 50mm. On this basis five areas of high risk can be found in Kenya. These are all characterized by moderate to high rainfall (over 800mm up to 2000mm) and a marked seasonality. The three areas of greatest risk are the northern coastal belt, the Kitui-Yatta area and the upper slopes of the Aberdares and Mount Kenya, all with mean p^2/P values lying between 81 and 110. The southern coastal belt and the footslopes of the Aberdares and Mount Kenya have rather lower p^2/P values lying between 51 and 80.

Much of Kenya can be included in the moderate category with p^2/P values lying between 31 and 50. There are two main areas in this category; the first includes the lower lying areas from the Athi-Kapiti plains in the south up through Isiolo to the northern border. This is an area of markedly seasonal rains, but with annual totals below 800mm. The second area is the Lake Basin in the west which has a higher rainfall between 1300 and 2000mm but a more even distribution through the year.

The areas of lowest risk, with p^2/P values between 11 and 30, include the low rainfall areas of Eastern Kenya, the Rift Valley, the Uasin Gishu plateau in western Kenya, the Mau Escarpment and the Laikipia plateau. These areas have a moderately high to low rainfall evenly distributed through the year.

Regional contrasts in rates of soil erosion in Kenya have been reviewed by Edwards (1977). He distinguishes two areas of particularly high erosion risk, the upper Tana catchment and the Basement Complex areas. The upper Tana catchment is one of the areas with a high p^2/P value. Steep slopes and intensive cultivation increase the risk already inherent in the rainfall distribution. Many of the areas underlain by the Basement Complex fall into the moderate risk category for p^2/P , but the risk will be aggravated by the erodible, sandy soils and poor vegetation cover that they support. The Kitui-Yatta area also includes Basement Complex soils; here the magnitude of the erosion risk due to a combination of rainfall and soil factors will be very high. Edwards also notes high erosion rates in the Baringo area. Although the Rift Valley has a low mean p^2/P value, that for Marigat was found to be 40.

The map of p^2/P (Figure 1) shows the erosion risk due to rainfall factors only and takes no account of topography, soils and landuse. Even so there appears to be a relationship between observed erosion rates and p^2/P values. Hence the map should indicate those areas of high erosion risk where conservation measures are most important, especially where the topography or soils aggravate the potential for erosion.

SEASONAL CHANGES IN STORM EROSIVITY AND THEIR RELATIONSHIP TO THE POTENTIAL SOIL MOISTURE DEFICIT, KATUMANI RESEARCH STATION, MACHAKOS DISTRICT

Katumani Research Station was selected as the example in this pilot study primarily because of the ready availability of five day rainfall and evaporation data from the monthly Farming Weather reports published by the Kenya Meteorological Department as well as rainfall records from a Dines tilting syphon

tropical gauge established in 1974. Katumani is also of interest because of the considerable amount of erosion research already carried out in this area (Thomas, 1974; Moore, 1979; Thomas et al 1979). The time span for the present study is from 1974 to 1981. This is a short period for the analysis of rainfall data, but is sufficient to point to certain relationships which can be explored further for other stations. The eight years analysed include a range of annual totals with five dry years (1974 to 1976, 1980 and 1981) and three wet years (1977, 1978 and 1979).

Estimation of rainfall erosivity

Rates of soil erosion have been related to a number of storm characteristics including the total rainfall depth, intensity and storm energy. Storm energy appears to be the most significant and has been widely used as the basis of indices of storm erosivity. Several such indices have been derived, but there does not appear to be any one which is the best universal predictor of soil erosion. These indices have been reviewed elsewhere (Lal, 1977; Moore, 1978; Morgan, 1979). The index adopted in the present study is the EI_{30} index as used by Stocking and Ellwell (1976) in their work in Zimbabwe. Hence direct comparisons can be made between the two studies. The EI_{30} index combines the total kinetic energy of a storm with the maximum sustained intensity lasting for thirty minutes. Monthly and annual erosivity is found by summing values for all storms over the relevant time period. Stocking and Ellwell give the following criteria for a storm:

- i) Storms must be separated by an interval of at least two hours; amounts of less than 0.25mm in one hour were regarded as zero rainfall.
- ii) A storm must have a maximum five minutes intensity greater than 25mm/hr.
- iii) Only rainfall occurrences greater than 12.5mm were considered as storms.

These criteria were adopted in the present study with the minor modifications of a maximum five minute intensity greater or equal to 25mm/hr and a minimum storm depth of 12.5mm. In all, seventy

four storms met these criteria.

For each of the seventy four storms the trace from the autographic gauge was divided into small time increments of uniform intensity and for each such period the rainfall depth, duration and, hence, intensity were noted. The kinetic energy for each time increment was estimated from the intensity; the kinetic energy for the storm was calculated by summing the individual values for all time increments. Hudson's relationship as used by Stocking and Ellwell (1976) was used to estimate kinetic energy from the intensity.

The relationship is given as:

$$E = 29.8 - \frac{127.5}{I} \text{ J/m}^2/\text{mm}$$

where E is kinetic energy and I is intensity in mm/hr. The total energy for the storm was then found as:

$$E_s = \sum_{i=1}^n \left(\left(29.8 - \frac{127.5}{I} \right) q_i \right) \text{ J/m}^2$$

where q_i is the quantity of rain in millimetres in time increment i . The E_s was then multiplied by the maximum sustained thirty minute intensity to give the EI_{30} index of storm erosivity.

The storm erosivity values (EI_{30}) were analysed as follows. Firstly, the seventy four storms were ranked by erosivity and the rainfall depth accumulated for the ranked storms. The percentages of rain over the eight year period falling as storms with an erosivity greater than given values were calculated. From the storm ranking the return period of storms of these same erosivities were estimated using a partial series of all storms.

For each month the erosivity for individual storms was summed and hence for the eight year period the mean monthly value was found. Similarly, the annual erosivities and mean annual erosivity were calculated. Further, the monthly distribution of rainfall as erosive storms and storms with erosivity greater than 10,000, 22,000 and 40,000 $\text{J-mm/m}^2\text{-hr}$ was found.

Estimation of the potential soil moisture deficit

The moisture budget for a soil is given by the general relationship

$$P = Et + \Delta S + R$$

where P is precipitation, Et is evapotranspiration, ΔS is the change in stored soil moisture and R is runoff or percolation. Evapotranspiration rates are controlled on the one hand by the evaporation potential as determined by atmospheric conditions and on the other hand by the availability of moisture in the form of precipitation and stored soil moisture. If the availability of moisture is low then actual evaporation falls below the potential and a soil moisture deficit develops, equal to the difference between the actual and potential evaporation. At such times vegetation will start to wilt and, if the deficit is severe or prolonged, the vegetative parts will die back altogether. The soil moisture deficit should therefore be a good indicator of live vegetation cover and hence the ability of the vegetation to conserve the soil.

Mean monthly estimates of the potential moisture deficit were taken from the soil moisture budget for Katumani analysed by Obasi and Kiangi (1977). Their values are derived from mean monthly estimates of precipitation and evaporation. The mean monthly deficits are shown in Figure 3, together with mean monthly erosivity. In addition an analysis of the five-day soil moisture budget was carried out on a continuous basis from September 1975 to December 1981. This allowed a detailed study of the timing of erosive rains with respect to real time changes in the soil moisture status. For each year the five-day potential moisture deficit and the erosivity of each storm were plotted as a bar graph. Examples for 1977 and 1980 are shown in Figure 4. From these graphs, individual storms were classified according to their timing with respect to the potential moisture deficit. Wet storms were defined as those occurring at a time when the five-day deficit had not exceeded 5mm for a period longer than ten days. All other storms were classified as dry. According to Moore (1978) many crops do not attain 50% cover until at least 30 days after planting so that although storms falling early in the wet season

have been classified as "wet", in terms of ground cover they are effectively "dry". Thus a classification based directly on the potential moisture deficit underestimates the potential erosion risk.

Results

The distribution of storm erosivity as a percentage of total rainfall is shown in Figure 2. The analysis showed that 37% of the rainfalls as erosive storms defined according to the given criteria. Some of these storms had a fairly low erosivity, 7% being between 2,000 and 6,000 J-mm/m²-hr. Such erosivities were equalled by other rainfall events of depths or intensities lower than those used to define an erosive storm. From a selection of these events the maximum erosivity was calculated as 5,460 J-mm/m²-hr for a rainfall depth of 22mm with a maximum five minute intensity of 17.3 mm/hr. Thus the percentage of storms with erosivities exceeding 2,000 J-mm/m²-hr will be greater than 37%.

It is unlikely that rainfall events with erosivities exceeding 10,000 J-mm/m²-hr would have been excluded from the analysis. Such storms made up 25% of the total rainfall. The equivalent percentage for 20,000 J-mm/m²-hr was 16% and for 40,000 J-mm/m²-hr was 7%. Storms of these erosivities had estimated return periods of 0.23, 0.5 and 1.3 years respectively. The maximum storm erosivity of 134,560 J-mm/m²-yr occurred in April 1981 when 98mm of rain were recorded in a period of 4½ hours. The value of I₃₀ for the storm was 58mm per hour. By extrapolation a storm of this erosivity would have a return period of around 50 years.

Annual erosivity, given in Table 1, ranged from a minimum of 16,000 J-mm/m²-hr in 1976 to a maximum of 346,343 J-mm/m²-hr in 1977. There does not appear to be a strong relationship between annual erosivity and annual rainfall, a result in line with Stocking and Ellwell's work. The mean for the eight year period is 164,362 J-mm/m²-hr. This figure is in the order of ten times those found by Stocking and Ellwell (1976) for Zimbabwe.

Their maximum mean annual erosivity was just over 14,000 J-mm/m²-hr. Morgan (1979, p.28) presents a graph for mean monthly storm energy at three stations in Zimbabwe, after work by Hudson. Hudson found a value for mean annual storm energy of 4,900 J/m² for Salisbury, a figure in general accordance with equivalent energy values for Katumani. Stocking and Ellwell's map of erosivity indicates a mean annual erosivity of 11,000 J-mm/m²-hr for Salisbury. Given Hudson's energy figure, this indicates an average value of 2mm/hr. For Katumani the values for I₃₀ ranged between 10 and 60 mm/hr. The discrepancy between Stocking and Ellwell's results and those for Katumani cannot be explained easily, but on account of the correspondence with Hudson's energy figures the Katumani results will be accepted as valid.

Turning now to the seasonal distribution, it can be seen from Table 2 and Fig. 3 that the month with the highest mean erosivity was April with a value of 69,668 J-mm/m²-h, coinciding with the highest mean monthly rainfall. Table 2 shows that the erosivity of individual storms was high. Of the total monthly rainfall 47% came as high erosivity storms and 15% as storms with an erosivity greater than 40,000 J-mm/m²-h. The timing of these erosive storms is such that the erosion risk is high coming as they often do at the beginning of the month when the potential moisture deficit is severe and the vegetation cover poorly established. Cultivation at this time would further aggravate the risk. This point is not fully brought out in Fig. 3 which shows April to be a month without a potential moisture deficit, but it can be seen for example in Fig. 4 which shows a sequence of highly erosive storms falling at the beginning of April 1977.

May had a much lower erosivity. 49% of the total monthly rainfall came as erosive storms, but these were generally of low to moderate erosivity. Only 12% of rainfall came as storms with erosivities greater than 20,000 J-mm/m²-hr and none exceeded 40,000. Figure 3 indicates a small mean potential moisture deficit in May, but the five day analysis showed that this was not present in wetter seasons. Generally May can be considered as a month with a good vegetation cover, thus indicating a low

erosion risk.

From June through to October erosivity was at a minimum. The total value for these months over the eight year period was accounted for by two moderate storms, one in July 1974 and one in September 1975. Thus, despite the dryness of these months and the consequent high potential moisture deficit, the erosion risk was low.

The erosivity of storms in the short rains was significantly lower than in the long rains (March to May). Although November had the second highest mean rainfall, it had a mean erosivity of only 15,306 J-mm/m²-hr and a maximum storm erosivity of 24,295 J-mm/m²-hr.

Only 29% of the monthly rainfall came as erosive storms. December had an even lower erosivity value, due largely to the infrequent nature of erosive storms. In some years storms of high erosivity occurred, as can be seen by the maximum value of 34,889 J-mm/m²-hr.

The period between the long and short rains had relatively high erosivities given the generally low rainfall. In January, February and March the percentage of monthly rain falling as erosive storms was 57%, 48% and 51% respectively. Mean erosivities were 13,150, 10,196 and 34,037 J-mm/m²-hr. The erosivity of individual storms tended to be high. In March 9% of the monthly rainfall came as storms with an erosivity exceeding 40,000 J-mm/m²-hr. The erosive storms in March may or may not have marked the beginning of the long rains, but in all cases they were associated with a high potential moisture deficit as were the storms of January and February. This would indicate that with a consequent poor vegetation cover the erosion risk during this period would have been moderate to high.

As a final analysis, storms were cumulated for wet and dry periods as defined in Table 3. With the exception of 1981, the higher proportion of erosive rains fell in the dry period. In 1980, 77% of the erosive rains fell in this period, due largely

to one high energy storm at the beginning of March. For all years an average of 60% of the annual erosive rainfall comes in the dry period when the vegetation cover is lowest.

CONCLUSIONS

The analysis of rainfall erosivity and potential soil moisture deficits at Katumani has shown that the period of greatest erosion risk is that immediately preceeding and at the start of the long rains in March and April. High storm erosivity is coupled with high potential moisture deficits. In certain years the erosion risk is also significant in January and February. For the rest of the year the risk is much less. The erosivity of storms occurring in the short rains of November to December is much lower than those associated with the long rains. In the dry season between the long and short rains erosive storms are rare and of low magnitude.

It cannot be assumed that the pattern for Katumani will apply to other stations in Kenya and further analysis is needed to extend the study to different climatic regions within the country. In 1974 the Meteorological Department extended its network of recording gauges so that data is now available for 34 stations. This should provide a reasonably substantive network for mapping regional variations in erosivity. Potential evaporation records are also widely available.

Conservation measures must cater for the maximum expected risk. Maps of annual erosivity average the risk through the year and hence mask the higher risk occurring for a short period. More useful for conservation purposes would be a map showing the maximum risk for this short period which for Katumani would be in March and April.

Before the present study can be extended two things are required. Firstly it is necessary to define the relationship between vegetation cover and the potential soil moisture deficit. Secondly the potential soil moisture deficit and storm erosivity should be combined so as to give an index of erosion

risk at different times of the year.

The author knows of only limited data on seasonal changes in vegetation cover and as yet no review has been made. It is hoped that some data for grassland communities will become available from current studies at Kenyatta University College. One other possibility considered is the use of Landsat imagery to monitor seasonal changes in vegetation cover, but the feasibility of such a study has not yet been looked into. Any further information for a range of plant communities and landuse systems would be most useful to the extension of this study.

REFERENCES

- Douglass, I 1967. Man Vegetation and the Sediment Yield of Rivers, NATURE, 215 pp. 925-8
- Edwards, K.A. 1977. 'Regional Contrasts in Rates of Soil Erosion and their Significance with Respect to Agricultural Development in Kenya' in Greenland D.T. and Wiley, L.R. (ed.) In the Role of Soil Physical Properties in Maintaining the Productivity of Tropical Soils, London.
- Fournier, S.F. 1962 Carte du Danger D'Erosion on Afrique au Sud du Sahara, 'Fonde Surel Aggresivite Climatique Et la Topopographie.' Notice Explicative. Cee-CCTA, Paris.
- Langbein, W.B. and S.A. Schumm, 1958. 'Yield of Sediment in Relation to mean Annual Precipitation.' Transactions of the American Geo-physical Union, 39, pp. 1076-84.
- Moore, T.R. 1979 'Land Use and Erosion in the Machakos Hills', Annals Association of American Geog., 69, 419-431.
- Moore, T.R. 1978. An Initial Assessment of Rainfall Erosivity in East Africa Technical Communication No.11 Department of Soil Science, University of Nairobi.
- Morgan, R.P.C. 1979. Soil Erosion. Longman.
- Obasi, G.O.P. and P.M.R. Kiangi 1977. Monthly Distribution of Water Balance Components in Kenya. Technical Memorandum No. 24. Kenya Meteorological Department, Nairobi.
- Stocking, M.A. and Elwell, H.A. 1976. Rainfall Erosivity over Rhodesia. Transactions Institute British Geographers, 1, 231-245.
- Thomas, D.B. 1974, Air Photo Analysis of Trends in Soil Erosion and Landuse in Part of Machakos District, Kenya. M.Sc. Thesis, University of Reading.
- Thomas, D.B., Edwards, K.A., Barber, R.G., Hogg, I.G.G. 1979. Runoff, Erosion and Conservation in a Representative Basin in Machakos District. Kenya. Paper presented to the International Conference on Agricultural Hydrology and Watershed Management. Ibadan Nigeria, Nov. 20 - 24th.
- Wischmeier, W.H. and D.D. Smith, 1965. Predicting Rainfall Erosion Losses from Cropland East of the Rocky Mountains. USDA Agr. Res. Serv. Handbook 282.

Table 1: Annual Storm erosivity, Katumani research station

| Year | Annual Rainfall mm | Annual Erosivity J-mm/m ² -hr | Erosive Storms as % Annual Rainfall |
|------|-----------------------|---|--|
| 1974 | 419 | 53,710 | 21 |
| 1975 | 588 | 81,223 | 39 |
| 1976 | 523 | 16,006 | 11 |
| 1977 | 884 | 346,343 | 50 |
| 1978 | 830 | 119,812 | 31 |
| 1979 | 954 | 247,991 | 39 |
| 1980 | 541 | 189,633 | 58 |
| 1981 | 648 | 260,175 | 39 |
| Mean | 673 | 164,362 | 37 |

Table 2: Distribution of storm erosivity (J-mm/m²-hr) by Month Katumani research station, 1974-1981.

| Month | Mean Rainfall (mm) | Mean Monthly Erosivity | Max EI ₃₀ for one Storm | % Rain Falling as Erosive storms | % Storms with EI ₃₀ greater than | | |
|-------|--------------------|------------------------|------------------------------------|----------------------------------|---|--------|--------|
| | | | | | 10,000 | 20,000 | 40,000 |
| Jan | 52 | 13,150 | 27,900 | 57 | 35 | 31 | 0 |
| Feb | 39 | 10,196 | 26,784 | 48 | 34 | 13 | 0 |
| Mar | 94 | 34,034 | 66,709 | 51 | 33 | 20 | 9 |
| April | 175 | 69,668 | 134,560 | 47 | 41 | 32 | 15 |
| May | 61 | 20,961 | 37,082 | 49 | 35 | 12 | 0 |
| June | 12 | 0 | 0 | 0 | 0 | 0 | 0 |
| July | 10 | 822 | 6,574 | 25 | 0 | 0 | 0 |
| Aug | 7 | 0 | 0 | 0 | 0 | 0 | 0 |
| Sept. | 9 | 301 | 2,407 | 21 | 0 | 0 | 0 |
| Oct | 28 | 0 | 0 | 0 | 0 | 0 | 0 |
| Nov | 136 | 15,306 | 24,295 | 29 | 10 | 4 | 0 |
| Dec | 72 | 7,094 | 34,889 | 12 | 12 | 5 | 0 |
| Year | 673 | 164,362 | 134,560 | 37 | 25 | 16 | 7 |

Table 3: Distribution of storm erosivity between 'Dry' and 'Wet' Periods, Katumani research station, 1976-81

| Year | Dry (J-mm/m ² -hr) | Wet | Dry as % Total Erosivity |
|-------|----------------------------------|---------|-----------------------------|
| 1976 | 10,302 | 5,704 | 64 |
| 1977 | 219,462 | 126,881 | 62 |
| 1978 | 62,240 | 57,572 | 52 |
| 1979 | 186,821 | 61,170 | 75 |
| 1980 | 133,760 | 55,873 | 77 |
| 1981 | 95,224 | 164,951 | 37 |
| Total | 707,809 | 472,151 | 60 |

Note: 'wet' period defined as one in which the potential moisture deficit had not exceeded 5mm per five days for more than ten days.

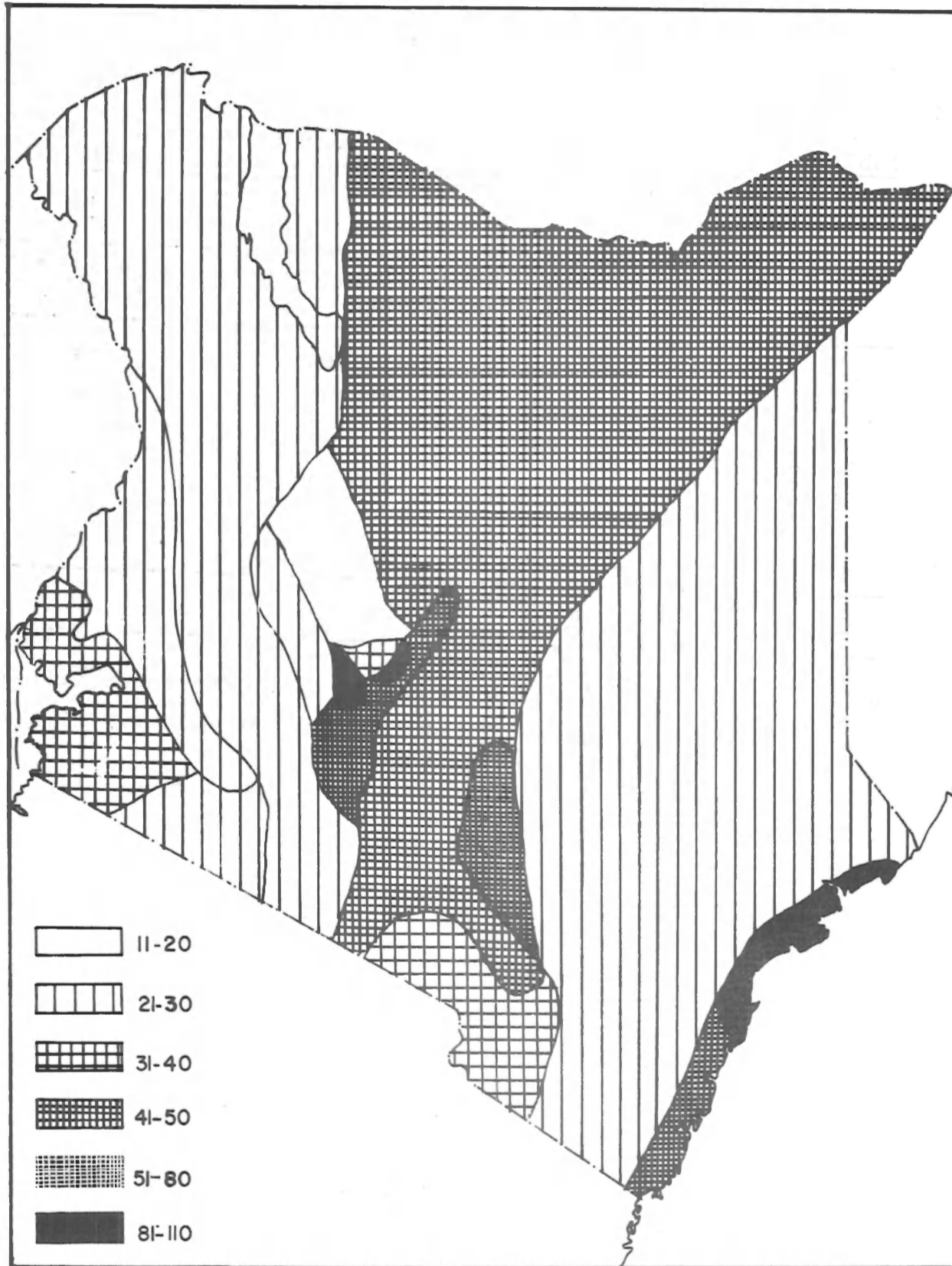

FIG. 1. REGIONAL VARIATIONS IN EROSION RISK AS GIVEN BY THE $\frac{P}{P}$ VALUE

FIG. 2. CUMULATIVE DISTRIBUTION OF STORM EROSIVITY

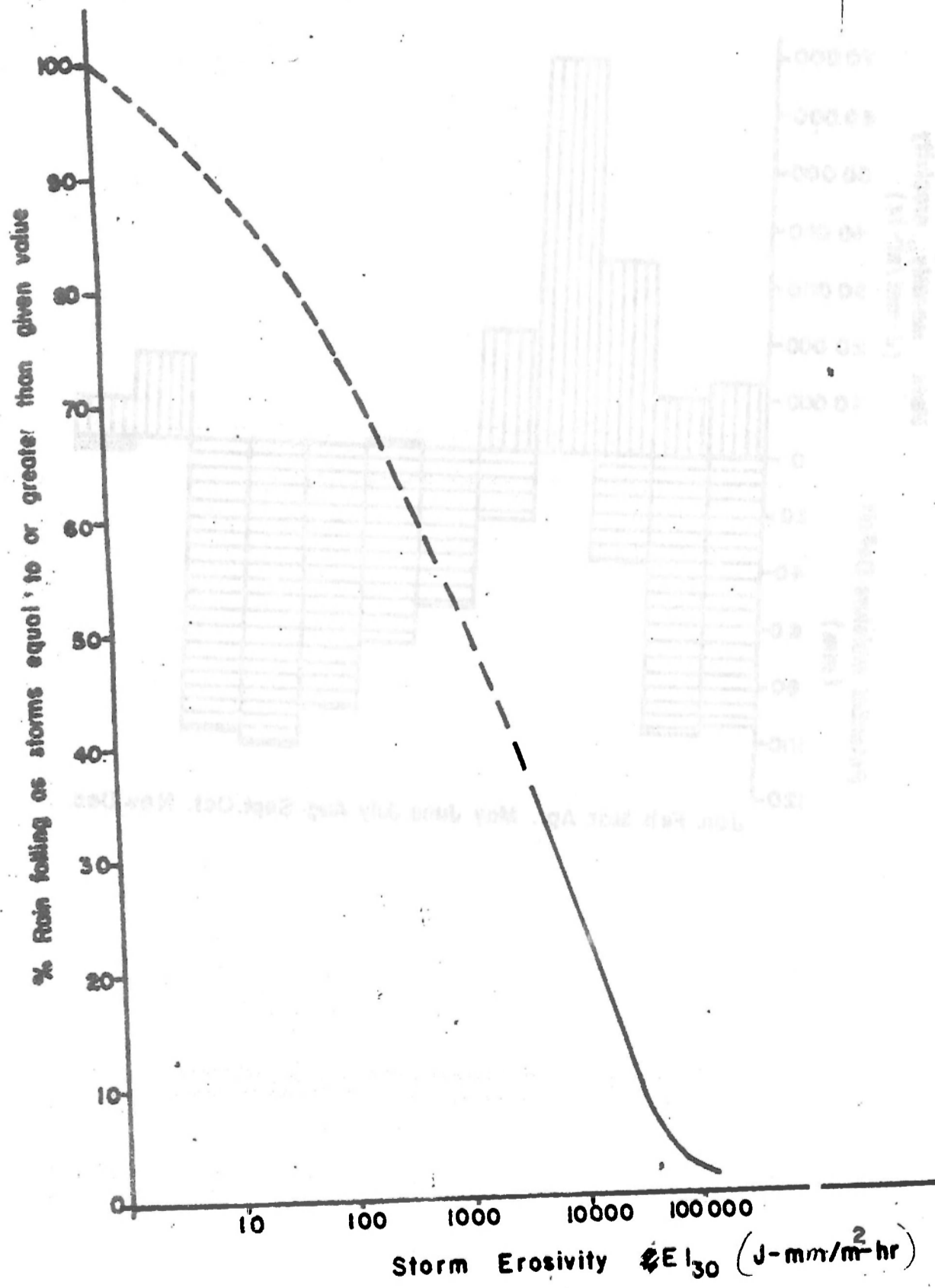

Fig. 3 Monthly Distribution of Storm Erosivity in Relation to Soil Moisture Budget. For Katumani Research Station.

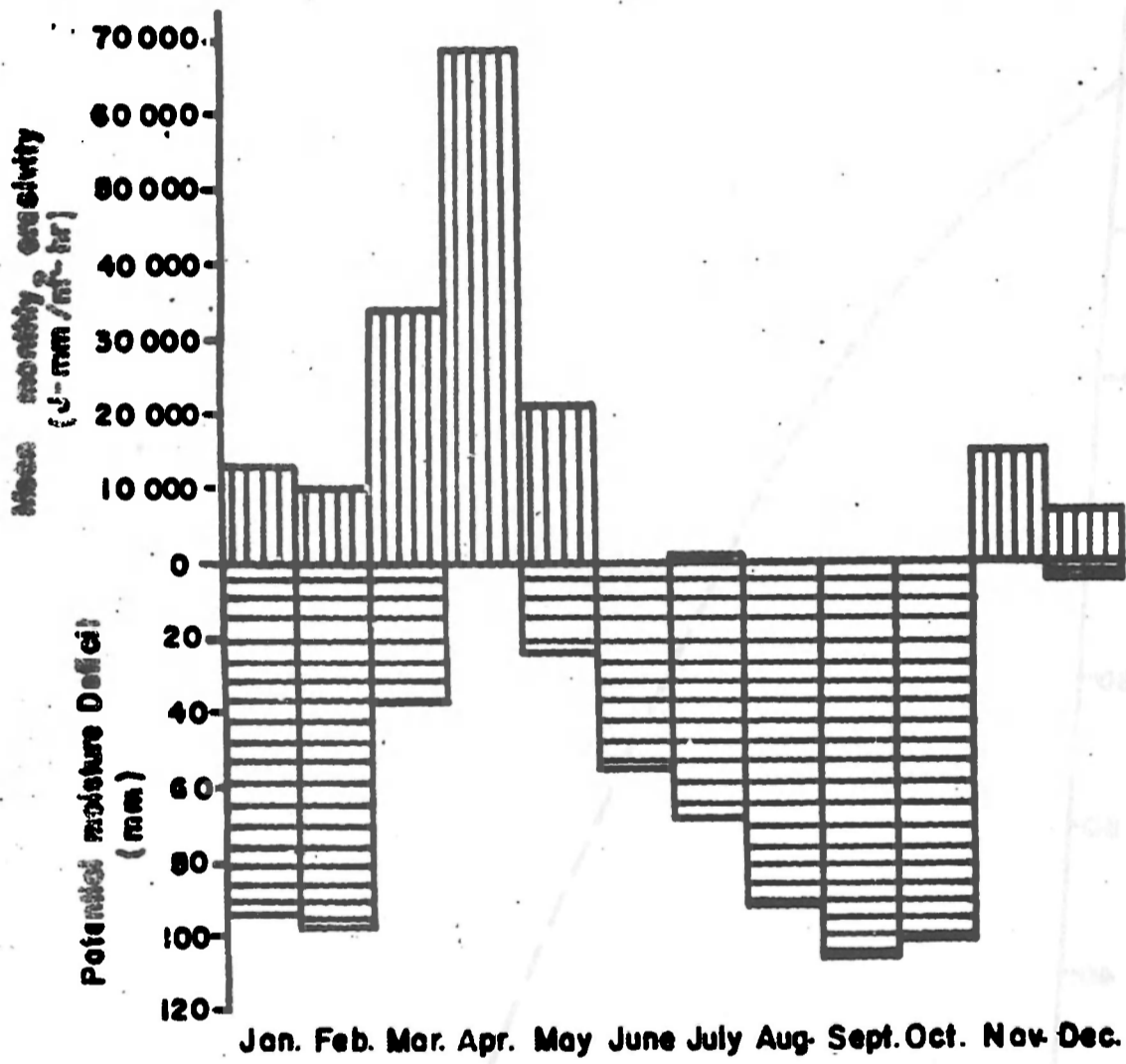
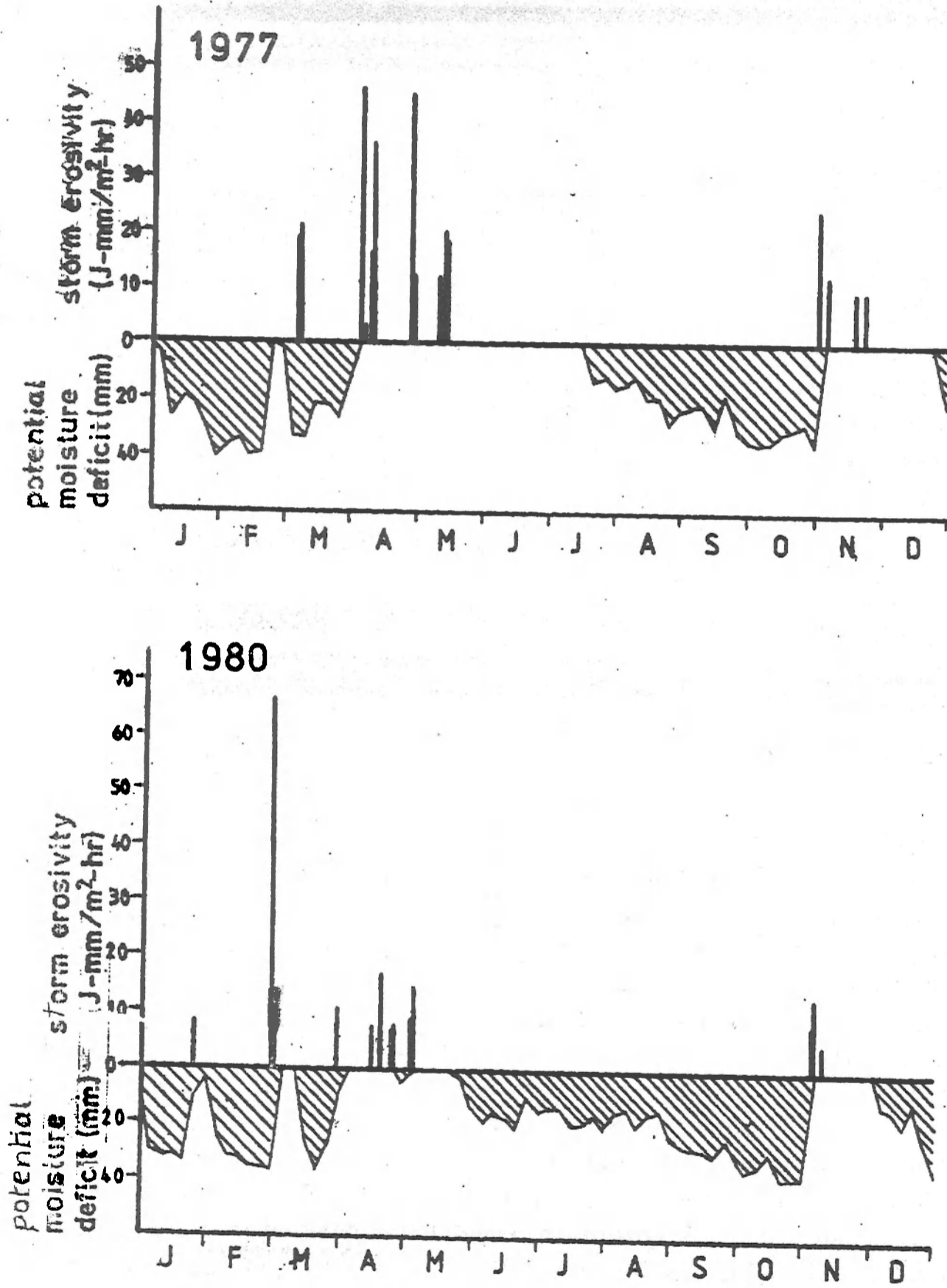

Fig. 4: Storm Erosivity and Potential Moisture Deficit, 1977 and 1980. For Katumani Research Station.



THE MAGNITUDES AND SOURCES OF SOIL EROSION IN SOME HUMID AND SEMI-ARID PARTS OF KENYA, AND THE SIGNIFICANCE OF SOIL LOSS TOLERANCE VALUES IN SOIL CONSERVATION IN KENYA.

By

R. G. Barber
Department of Soil Science
University of Nairobi

INTRODUCTION

Alarmingly high measurements of soil erosion rates have been published by various workers in Kenya for both humid areas (Dunne and Ongweny, 1976; Ongweny, 1979) and semi-arid areas (Dunne, 1977; Dunne et al. 1978; Moore, 1979; Thomas et al., 1981). Dunne (1979) has shown that the dominant factor controlling soil losses is land use. In this paper examples are given of some of the problems associated with assessing the magnitudes, sources and erosion processes responsible for these high soil losses. This is followed by a discussion of the choice of tolerable soil loss values and their significance in relation to conservation measures for cultivated land.

THE MAGNITUDES, SOURCES AND EROSION PROCESSES RESPONSIBLE FOR SOIL LOSSES IN SOME HUMID AREAS OF KENYA.

Catchment Sediment Yields and Soil Losses From Hillsides

Most of the published data on erosion rates in the humid areas of Kenya are based on measurements of suspended sediment transport rates from drainage basins (Dunne, 1974). Data for the average annual sediment yields from five catchments of the Upper Tana river in the Aberdares are given in Table 1 (Dunne and Ongweny, 1976; Ongweny, 1979). The calculated values are based on corrected sediment rating curves and river flow duration curves for the periods 1956-1970 and 1970-1977. The average sediment yields range from 369 to 1356 t/km²/yr. Sediment yields from the cultivated areas in each catchment were calculated from the areas under forest and cultivation, and an assumed sediment yield of 20 t/km²/yr from the forested areas (Ongweny, 1979). Sediment yields from the cultivated areas are appreciably higher than the average catchment sediment yields, and range from 507 to 3036 t/km²/yr and from 786

to 4707 t/km²/yr for the two periods of flow data. When these values are converted into equivalent average reductions in soil depth, assuming a soil bulk density of 1.0, the highest values are 2.6 and 4.7 mm/yr for the Maragua and Mathioya catchments respectively. However, these values in Table 1 are for suspended sediment loads and exclude bed load contributions which Dunne and Ongweny (1976) assume to be about 10% because of the fine textured nature of the soils. It is also claimed (Dunne, 1979) that the suspended sediment yield values are a reasonably accurate estimation of the rates of soil loss from the hillsides, i.e. that the sediment delivery ratio, which relates catchment sediment yields to the amount of soil loss from hillsides, is close to 1.0, Edwards (1979) however, estimates a sediment delivery ratio of not more than 0.10, which would give hillside erosion rates of at least 10 times the values given in Table 1. As yet, there are no reliable local data from which sediment delivery ratios can be estimated for drainage basins in Kenya. Nevertheless, the annual rates of soil loss from cultivated lands in the Mathioya and Maragua catchments are very high, and if it is assumed that interrill and rill erosion are the dominant erosion processes, the above values are substantially greater than the maximum tolerable soil loss values used in the USA (Arnoldus, 1977).

Table 1: Suspended sediment yields from sub-catchments of the Upper Tana river in the Aberdares (Dunne & Ongweny, 1976)

| Catchment | Average Sediment Yield | Sediment Yields from Cult. Land | | | |
|--------------|-------------------------|---------------------------------|--------|----------------------|-------|
| | (t/km ² /yr) | (t/km ² /yr) | | (mm/yr) ⁺ | |
| | (a) | (a) | (b) | (a) | (b) |
| Upper Sagana | 415* | 793* | 1229 | 0.8* | 1.2 |
| Mathioya | (886) | (3036) | (4706) | (3.0) | (4.7) |
| Maragua | 1356 | 1684 | 2610 | 1.7 | 2.6 |
| Thika | 447 | 507 | 786 | 0.5 | 0.8 |
| Chania | 369 | 719 | 1114 | 0.7 | 1.1 |

* based on 1960-1970 flow data

(a) based on 1956-1970 flow data

(b) based on 1970-1977 flow data

+ assuming a soil bulk density of 1.0

() estimated values.

Source: Dunne and Ongweny, 1976.

The Soils in the Mathioya and Maragua Catchments and their Erosion Susceptibility

The dominant soils in the Mathioya and Maragua catchments are humic andosols, humic and eutric nitosols (Sombroek, 1980). The humic andosols are mainly under forest, pasture or cultivated with tea and would be expected to give very low sediment yields (Ongweny 1979; Othieno, 1975). The eutric nitosols, and by inference the humic nitosols, have been shown to possess a very low erodibility (Barber, *et al.* 1979), i.e. they are characterised by a high inherent resistance to erosion. This has led some workers to state that there are therefore no serious erosion problems on the nitosols! Thus the high sediment yields in the Mathioya and Maragua catchments may appear to be unexpected. However, erosion rates depend not only on soil erodibility, but also on the erosivity of the climate, slope gradient, slope length, and on the crop management and conservation practices. Hence, although the nitosols have a low erodibility compared to other soils, due to their very stable microstructure (Ahn, 1979), they can still give rise to high erosion rates on long, steep slopes where annual crops are cultivated in the absence or near absence of conservation measures. These in fact are the conditions found in many parts of the Mathioya and Maragua catchments. Moreover, Tefera (1981) has shown that when a eutric nitosol from Kabete was subjected to various moisture contents for the prolonged period of 16 hours, the structural stability decreased exponentially with increasing aggregate moisture content (Fig. 1). This may account for the very high soil losses measured from small (1.5 m²) plots on a eutric nitosol at Kabete from two intense rain storms falling on wet soils during May 1979 (Table 2). The values given are mean values from 6 plots.

Table 2: Erosivity and Soil Loss at Kabete

| Date | Amount of rain (mm) | R Factor (English units) | Soil Loss | |
|---------|---------------------|--------------------------|----------------------|---------|
| | | | (Kg/m ²) | (t/ha)* |
| 10.5.79 | 49 | 30 | 1.11 | 11.1 |
| 26.5.79 | 62 | 13 | 0.81 | 8.1 |

*Extrapolation of soil losses to tonnes/ha from kg/1.5m² cannot be considered reliable.

The Sources of and Erosion Processes Responsible for the High Sediment Yields

The data in Table 1 establishes that erosion rates from cultivated land in the humid areas can be very high, but gives no indication of the nature of the erosion processes responsible nor the precise sources of the sediment. To what extent are the eroded sediments derived from interrill and rill erosion, stream bank erosion or from mass movement? And to what extent are the sediments derived from cultivated fields, from dirt roads and footpaths, or from ditches and drainage channels? The type of conservation measures required to reduce the basin sediment yields will clearly depend on the source of the sediments and the nature of the erosion processes responsible.

Road and Footpath Erosion

Dunne (1979) has emphasized the important contribution to catchment sediment yields made by the erosion of dirt roads and footpaths, which in heavily populated areas often form a dense network linked to the streams and rivers. From measurements of the total surface area of dirt roads in a part of the Chania basin, Dunne estimated, on the basis of soil loss measurements from rural roads in N. America, that 15-35% of the Chania sediment yield could have originated from dirt roads. Dunne also claimed that the sediment contribution from footpaths could be of a similar order of magnitude to that from the roads. Thus 30 to 70% of the catchment sediment yields could have been derived from road and footpath erosion.

Gulley Erosion

Gulley erosion appears to be an important source of sediments in many of the Upper Tana river catchments, particularly since the construction of tarmac roads. Often this has led to greatly increased runoff volumes from the tarmac surfaces, exceeding the discharges with which the existing drainage ways were in equilibrium prior to the construction of the tarmac roads, and as a result gulley and stream bank erosion have developed. However,

there are, to the author's knowledge no reliable estimates of the sediment yields caused by gully erosion in any of the Upper Tana catchments.

Mass Movements

The significance of mass movement as an erosion process and source of sediments in drainage basins has been largely overlooked in the past. However, the Kangema Divisional Agricultural Office has recorded 40 mass movements in a 300 km² area within the Mathioya and Maragua catchments. In a recent study by Kamau (1981), 35 of these mass movements were associated with humic andosols, on slopes of 55-80%, that were cultivated with tea, coffee, pyrethrum, maize and vegetables. Kamau estimated that the 40 mass movements had mobilised about 1,000,000 m³ of soil, equivalent to about 3,000 t/km² in the area sampled. Although most of the mobilised soil does not directly enter the drainage channels, 4 out of the 10 mass movements studied by Kamau extended to the river banks, and had changed from landslides or earthflows into mudflows at the foot of the mobilised soil mass. Continuing mudflow movements combined with stream bank erosion had noticeably increased the river water turbidity. Moreover, most mass movements were observed to be very susceptible subsequently to other erosion processes. A detailed study at one of the sites, a humic andosol at Wanjerere, showed that the soil behaved as an extra-sensitive 'clay', i.e. its liquid limit (the moisture content at which a remoulded soil first attain viscous properties) was less than the soil's natural moisture content, even up to 24 hours after saturation (Fig. 2). Such soils are particularly susceptible to mass movements. Moreover, Kamau showed the andosols to have a very high water sorption capacity compared to nitosols (Fig. 2), and consequently the component of the soil mass acting along a potential shear plane will be greatly increased during periods when the soil is close to saturation (Fig. 3). At such times the soils shear strength will be greatly reduced because of higher pore water pressures reducing both the cohesion and the soil's internal frictional strength. Under these conditions the probability of landslides or earthflows occurring will be greatly enhanced. Kamau (1981)

states that about 80% of the 40 mass movements were triggered by very heavy rainfall in May 1981 when more than 300 mm rain fell in 8 consecutive days. Some evidence suggested that mass movements in this area have coincided with high (3000 mm) annual rainfall totals with a recurrence interval of about 10 years. If this is correct the rate of mass movement would be about 300 t/km²/yr, but the rate at which such mobilised soil masses would enter the drainage system would be much slower. No estimates of mass movement contributions to catchment sediment yields are available for Kenya.

Estimation of the Extent of Rill and Interrill Erosion from Cultivated Land

The area of land that becomes degraded by gulley erosion, mass movements, stream bank, road and footpath erosion is probably very small compared to the size of the catchment, but the contribution to the total sediment yield may be very significant. Thus the estimated average annual reductions in the soil depth from cultivated fields (Table 1) may be overestimates. The only reliable data for soil losses by rill and interrill from the humid areas are those obtained by Othieno (1975) at Kericho on a humic nitosol from runoff plots on 10% slopes. Rates of soil loss in the first year from young tea fields and with interplanted oats were 161 and 34 t/ha/yr respectively. Clearly, much more data is required, including reliable estimates for sediment delivery ratios, before any reasonable estimates can be made of the annual rates of soil depth reduction by rill and interrill erosion from farmers' fields. Such information can best be obtained by installing runoff plots in farmers fields on different soils, slopes and for different crops. Once a certain amount of runoff plot baseline data has been obtained, portable rainfall simulators can be used to give comparative soil loss values with which to extrapolate the runoff plot data to other soil types.

THE MAGNITUDES, SOURCES AND EROSION PROCESSES RESPONSIBLE FOR SOIL LOSSES IN SOME SEMI-ARID AREAS OF KENYA.

Catchment Sediment Yields

In the semi-arid areas the available data on catchment

sediment yields is much more limited, and partly reflects the difficulties of taking regular samples from seasonal streams (Edwards, 1979). Moreover, many of the semi-arid catchment areas are associated with coarse grained Basement Complex rocks where bed loads are likely to form a major contribution to the total sediment load. The difficulties of measuring bed loads and estimating sediment delivery ratios may produce large errors in the estimated sediment production rates from hillsides in the semi-arid areas. However, the problem of estimating the total load was largely overcome in the Tiuni catchment, Machakos District, by constructing a weir with a level approach channel from which the 'bed load' deposits could be periodically measured and removed. The 'suspended sediment load' was automatically sampled from the flow passing over the weir. From a limited period of measurements, the catchment sediment yield was estimated to be 535 t/km²/yr (Thomas, et al., 1981). Although this value is typical for many catchments in the semi-arid areas, higher values of up to 1,500 t/km²/yr have been estimated from the Maruba river, Machakos District (Edwards, 1979) and even as high as 20,000 t/km²/yr equivalent to 20mm/yr from a steep grazed catchment (Dunne, 1979).

Sources of, and Erosion Processes Responsible for the High Sediment Yields

Measurements of soil losses from each of the main land use types in the Tiuni catchment with a rainfall simulator showed that the ratio of soil losses per unit area was 50:15:1 for the degraded grazing land: cultivated land: good grazing land (Thomas et al., 1981). Using these comparative values of soil loss, the land use areas, the estimated catchment sediment yield and an assumed maximum sediment delivery ratio of 0.2, the minimum rates of soil loss were estimated as shown in Table 3.

These values show that the degraded grazing land is the major source of eroded sediment. The minimum soil loss rate of 4.5 mm/yr is not dissimilar, bearing in mind that it is a minimum value, to the estimates of 5 - 15 mm/yr obtained by Moore (1979) from measurements of exposed Cenchrus ciliaris and Acacia spp.

Table 3: Minimum rates of soil loss from different land use types in Eiuni catchment, Machakos district (Thomas et al., 1981)

| Land Use Type | % of Catchment | Soil Loss Ratio | Minimum Soil Loss Rates (t/km ² /yr) | Soil Loss Rates (mm/yr) |
|---|----------------|-----------------|--|----------------------------|
| Degraded Grazing Land | 37 | 50 | 5,330 | 4.5 |
| Cultivated Land | 43 | 15 | 1,600 | 1.3 |
| Good Grazing Land, Bush and Woodland | 20 | 1 | 110 | 0.07 |

Source: Thomas et al., 1981.

roots in the same area. Moore's estimates can probably be regarded as fairly reliable. The minimum estimated soil loss rates from all but the good grazing land, bush and woodland are well in excess of the maximum tolerable soil loss values accepted in the USA (Arnoldus, 1977). However, the soil loss ratios for the three land use types obtained with the rainfall simulator reflect the susceptibility of the land to rill and interrill erosion. The contributions from gully, stream bank, road and footpath erosion are unknown, but could be very significant if the minimum values given in Table 3 seriously underestimate total soil losses from the hillsides.

Thus the same situation arises as for the humid areas, viz that much more data is required before the precise sources, magnitudes and erosion processes responsible for the high catchment yields can be established for the semi-arid areas. Estimates of the annual reductions in soil depth from rill and interrill erosion from cultivated land can best be obtained from runoff plots in combination with rainfall simulators as discussed in Section 2.7.

COMPARISON BETWEEN CURRENT ACCELERATED AND CURRENT NATURAL EROSION RATES

Sections 2, and 3 have stressed the very high, current accelerated erosion rates due to man's influence from some drainage basins in both humid and semi-arid parts of Kenya. At the same

time, the lack of knowledge concerning the precise sources of these sediments, their magnitudes, and the nature of the erosion processes responsible have been emphasised. Some of the values for erosion rates, particularly those obtained by tree root and mound measurements in the semi-arid grazing lands (Moore, 1979; Dunne *et al.*, 1978), are probably reasonably reliable. The extremely low soil loss rate obtained from a humid grazing area at Kabete, albeit with a rainfall simulator, (Barber and Thomas, 1981), is also probably realistic. The only reliable rates of soil loss from humid cultivated land are those obtained by Othieno (1975) from runoff plots on nitosols planted with young clonal tea plants with and without interplanted oats. The rates of erosion from cultivated land in the semi-arid areas viz. from the Iiuni study (Thomas *et al.*, 1981) and with a rainfall simulator (Barber *et al.*, 1979) cannot be regarded as realistic in absolute terms. These estimates of the current accelerated erosion rates are presented in Table 4 for comparison with the current natural or geological rates of erosion estimated by Dunne (1979).

It is apparent from Table 4 that even though the validity of some of the accelerated erosion rates is doubtful, the rates are nevertheless one or two orders of magnitude higher than the natural erosion rates, with the exception of grazing land in the humid areas.

The Relevance and Significance of Soil Loss Tolerance Values

Soil loss tolerance (T) values are the maximum permitted soil loss rates that 'will permit a high level of crop productivity to be maintained economically and indefinitely' (Wischmeier and Smith, 1978). The generally accepted T values for renewable and non-renewable soils are given in Table 5 (Arnoldus, 1977), and are primarily based on soil rooting depths. These values apply to areas where rill and interrill erosion are the dominant erosion processes, i.e. where soil losses occur more or less uniformly over the land surface.

Table 4: Estimated Natural and Accelerated Current Erosion Rates (mm/yr)

| | Natural erosion rates | | Accelerated erosion rates | |
|-------------------------------------|-----------------------|----------------------|--|---|
| | | | Grazing land | Cultivated Land |
| Humid areas (Volcanic rocks) | 0.02 | to 0.03 ^a | 0.0001 ^c | 5.8 ^f 28.3 ^g |
| Semi-arid areas (Basement rocks) | 0.04 | to 0.12 ^b | 5 to 15 ^d 5.3 to 10.5 ^e | (1.3) ^h (0.6 to 5.5) ^j |

() denotes particularly unreliable values

a Dunne (1979) for forested areas

b Dunne (1979) for lightly grazed woodland, bush and grassland.

c Barber and Thomas (1981) from rainfall simulator trials; good pasture land, 10% slope, eutric nitosol, Kabete.

d Moore, (1979) from tree and grass root exposures; degraded grazing land, chromic luvisols and orthic ferralsols, Iiuni.

e Dunne et al., (1978) from tree root and mound measurements; degraded grazing land, sandy clay loams, Amboseli.

f Othieno, (1975) from runoff plots; young tea interplanted with oats, 10% slope, nitosol, Kericho.

g Othieno (1975) from runoff plots; young tea, manually cultivated, 10% slope, nitosol, Kericho.

h Thomas, et al., (1981) from catchment yields and rainfall simulator trials, Iiuni.

j Barber et al., (1979) from rainfall simulator trials, 10% slope, ferral-chromic luvisol, Katumani.

A knowledge of the T value for a particular soil is intended to help, by application of the Universal Soil Loss Equation (USLE) (Wischmeier and Smith, 1978), in selecting appropriate land use types and management practices, to ensure that the resultant rate of soil loss does not exceed the T value. On the other hand Bennema and De Meester (1981) have suggested that the selected T value should be determined not only by the nature of the soil, e.g. its depth and fertility profile, but also

Table 5: Guide to Assessing Soil Loss Tolerance (T) Value

| Rooting Depth (cm) | Soil Loss | | Tolerance Values | |
|--------------------------|---|-----------------------------------|---|-----------------------------------|
| | Renewable soils ^a t/ha/yr | Loss soils ^a mm/yr* | Non-renewable soils ^b t/ha/yr | Loss soils ^b mm/yr* |
| 0 - 25 | 2.2 | 0.18 | 2.2 | 0.18 |
| 25 - 50 | 4.5 | 0.37 | 2.2 | 0.18 |
| 50 - 100 | 6.7 | 0.56 | 4.5 | 0.37 |
| 100 - 150 | 9.0 | 0.75 | 6.7 | 0.56 |
| > 150 | 11.2 | 0.93 | 11.2 | 0.93 |

a Substrata can be economically transformed into favourable rooting medium.

b Substrata cannot be economically transformed into favourable rooting medium.

* Assuming a soil bulk density = 1.2g/cm^3

by the type of land use being considered. Thus the tolerable soil loss for a shallow rooted crop in a deep soil may be quite unacceptable for a deep rooted crop growing in the same deep soil. Bennema and De Meester have therefore proposed that the acceptable rate of land degradation due to erosion, which takes land use into account, is more meaningful than the tolerable soil loss rate based only on soil depth. This approach has obvious merits, but problems could arise if changes in the type of land use, or changes in the face of the downstream water are likely to arise in the future. Thus if a fairly high T value is selected for a shallow rooted crop being grown in a deep soil for a particular area, the resultant decrease in soil depth with time may later preclude the possibility of changing the land use to a deep rooted crop, even though this may be desirable because of changing social or economic circumstances. Consequently the author advocates that soil losses should always be restricted to the minimum possible values unless this is totally unfeasible on economic grounds.

How valid are the T values given in Table 5, and how applicable are they to different environmental conditions in

Kenya? The maximum T value of 11.2 t/ha/yr was established in the USA on the basis of very scanty evidence suggesting that the rate of formation of the top humic A₁ horizon in a permeable, medium textured soil in well managed crop land was about 11.2 t/ha/yr or 0.9 mm/yr (Bennett, 1939). This rate of formation is much faster than the rate at which most parent materials weather to form soil. The average weathering rate for unconsolidated parent material is about 1.1 t/ha/yr, equivalent to about 0.09 mm/yr (Smith and Yates, 1968; Smith and Stamey, 1965). The rates at which consolidated parent materials weather are much slower, particularly in semi-arid and arid environments. Dunne et al., (1978) have estimated soil formation rates in Kenya of 0.18 to 0.30 t/ha/yr (0.014 to 0.024 mm/yr) from consolidated parent material in the humid areas and rates less than 0.125 t/ha/yr (<0.01 mm/yr) from consolidated parent materials in semi-arid regions. These soil formation rates are appreciably lower than the accelerated erosion rates except for grazing land in the humid areas (see Table 4), and consequently soil depth will rapidly diminish (Fig. 4) especially for the degraded grazing lands in semi-arid areas. In a more detailed analysis of the life span of soils, Dunne et al., (1978) has shown that, in the absence of any conservation measures being introduced, about 50% of the Amboseli grazing lands on Basement Complex rocks will have been stripped of their soil cover within 50 to 125 years, depending on the future rate of erosion. The problem may be almost as acute in some of the cultivated areas. Even without any interference from man, the estimated soil formation rates are lower than the current geological erosion rates.

If conservation measures and cropping practices are introduced for cultivated land, using an appropriate T value e.g. 6.7 t/ha/yr for a soil of 120 cm depth, the thickness of the soil's A horizon may be preserved, but the soil's rooting depth will still decrease. A comparison between the rate of soil loss governed by a tolerable soil loss value of 6.7 t/ha/yr and soil formation rates is shown in Table 6.

Table 6: Estimated Soil Formation Rates and Tolerable Rates of Loss for A Soil of 120 cm Rooting Depth

| | Soil formation rate from consolidated rocks (mm/yr) | Rate of soil loss for T value of 6.7 t/ha/yr (mm/yr) |
|-------------------------------------|---|--|
| Humid areas (Volcanic rocks) | 0.014 to 0.024 ^a | 0.56 ^b |
| Semi-arid areas (Basement rocks) | < 0.01 ^a | 0.56 ^b |

^aDunne et al., (1978)

^bAssuming a soil bulk density = 1.2

From Fig. 4 it can be seen that even when 'good' conservation and management practices are implemented so that the tolerable soil loss value is not exceeded, soil depth will still be reduced by 20% within about 350 years or 17 generations. Reductions in soil depth become particularly serious in semi-arid areas where the quantity of available water is frequently the most limiting factor in crop production. If a relatively large proportion of the seasonal rainfall occurs in a few very heavy storms, which is the situation in much of semi-arid Kenya, then the soil must be deep enough (i.e. possess an adequate available water capacity, to retain most of the water from these heavy storms if the crop is to reach maturity. As the soil depth decreases, the soil's capacity to retain water will steadily decrease, and the yield and the probability of obtaining a crop will both be reduced. It can therefore be concluded that soil loss tolerance values do not permit 'a high level of crop productivity to be obtained economically and indefinitely!.' This raises ethical and moral considerations which have been discussed by McCormack and Young (1981). The more we permit soil degradation to occur, the more difficult and the more costly it will be for future generations to halt degradation and to restore soil productivity. Future generations will undoubtedly benefit from our efforts to control erosion, and we surely have a responsibility to conserve our soil for their benefit, even if the costs

involved are uneconomic on a short term basis.

POSSIBLE APPROACHES FOR REDUCING SOIL EROSION RATES

Recent evidence has suggested that soil erosion rates in Kenya are increasing. In the semi-arid grazing areas Dunne *et al.*, (1978) have shown a three- to four-fold increase in erosion rates in the Amboseli area during the 10 to 15 years prior to 1976. Ongweny (1979) has reported significantly higher catchment sediment yields from the humid cultivated areas of the Aberdares from 1970 to 1977 compared to the period 1956 to 1970. In the predominantly semi-arid cultivated areas of Machakos, Kitui and Embu Districts, data for the annual food production per mm of rainfall has decreased from $1.09 \cdot 10^6$ kg/mm rainfall in 1970 to $0.48 \cdot 10^6$ kg/mm rainfall in 1976 (Government of Kenya, 1978). This decline in productivity has been attributed to land degradation by water erosion. Thus the problem appears to be getting steadily more serious. Moreover even the implementation of management practices based on the generally accepted soil loss tolerance values will not succeed in maintaining the productivity of land on a sustained basis. Ideally, rates of soil erosion should be restricted to soil formation rates, but in most cases, and particularly where terraces are graded to permit discharge, it is extremely difficult, if not impossible, to restrict erosion even to 1.1 t/ha/yr i.e. 0.09 mm/yr (McCormack and Young, 1981). Soil formation rates in Kenya are generally less than 0.024 mm/yr. The problems may seem insuperable, yet that should not dissuade us from striving to minimise the rate at which land is being degraded. The following discussion refers to just a few measures which may be of help in reducing soil losses from cultivated land.

For the semi-arid areas, apart from the steeper land, it has been proposed that level (end-to-end) steep backslope terraces should be constructed with partially closed ends (Thomas *et al.*, 1980; Barber *et al.*, 1981). Such terraces, by acting as closed systems, should restrict soil and water losses to very low values, provided the 'lip' is of adequate height and the terraces are properly constructed and well maintained. A

nomograph has been produced to assist in obtaining the correct design specifications. With time these terraces will develop by natural erosion and tillage practices into level (front to rear) bench terraces (Fig. 5), when further soil and water losses should be negligible. However, these claims need to be verified by further research and particularly with respect to the maximum slopes on which they will be effective. Spacing of these terraces must be selected so that the reduction in soil depth along the upper parts of the terrace, during the transformation to level bench terraces, does not result in the soil depth being reduced beyond the minimum value required by the crop. The relationship between tolerable reduction in soil depth, slope of the land and the optimum terrace width has been given by Barber and van Eijnsbergen (1981).

One of the main factors responsible for high soil and runoff losses from cultivated land is the development of surface crusts. Tefera (1981) has shown for a wide range of Kenyan soils that crust thickness is highly correlated with per cent runoff ($r = 0.81$)** and soil loss ($r = 0.80$ **). A previous laboratory study on the effectiveness of three soil conditioners applied at different concentrations to a highly erodible luvisol, showed that polyvinyl acetate (PVAc) was the most effective in reducing surface crusting and gave 97% and 84% reductions in runoff and soil loss respectively when compared to controls, (Barber, 1979). Subsequent field trials with PVAc confirmed its effectiveness in reducing erosion and runoff (Barber and Thomas, 1981), and PVAc appears not to be readily degraded in temperate soils (Young and Harris, 1976). However, its persistence in tropical soils requires further study (Harris, 1982). In the semi-arid areas the increased infiltration due to the PVAc infiltration would be expected to give higher crop yields (Dowker, 1963) and to offset to a greater or lesser extent the costs of applying the PVAc. Preliminary analyses (Barber, 1979) suggest that PVAc may be economical for some high value crops, in addition to reducing soil erosion, but this needs to be substantiated by further studies in the field.

In the humid areas the much higher rainfall is likely to preclude the widespread use of level (end-to-end) steep back-slope terraces. Graded terraces capable of discharging excess runoff are probably more appropriate, but additional measures may still be needed to restrict soil losses to minimum values. If detachment is the limiting factor it will be preferable to reduce the rate at which soil particles are detached. Songambele (1982) has convincingly demonstrated that the application of filter mud at 30 and 60 t/ha greatly reduced the detachability of two soils (Fig. 5) as measured by the water drop test of Bruce-Okine and Lal (1975). There is also evidence suggesting that the application of organic manures to a humic andosol at Gituamba has significantly reduced its detachability. Grass mulches at rates of 1, 2 and 4 t/ha and PVAc applications have also been shown to reduce detachment from a eutric nitosol at Kabete (Barber and Thomas, 1981). If transportation is the limiting factor it will be preferable to reduce the transportation capacity of the overland flow. Possible approaches would be the construction of ridges parallel to the contours, the application of mulches or crop residues, and by the use of grass strips. Studies on the latter method have recently been initiated by Tefera, (1982) but the effectiveness of mulches and crop residues on different soil types and slopes still needs to be investigated.

CONCLUSIONS

Although considerable data exist from both humid and semi-arid areas showing that sediment yields in many rivers are unacceptably high, there is very limited evidence to indicate the precise sources and erosion processes responsible for these high erosion rates. The contributions from gully, road, foot-path and stream bank erosion and from mass movements have not been quantified, but may contribute significant proportions to the total sediment yields. In such cases the high soil losses often assumed to be derived from cultivated land may be over-estimates. Very little reliable data is available for soil losses by rill and interrill erosion from cultivated land, though some probably reliable data has been recorded from grazing land. It is recommended that runoff plots need to be established in the

cultivated areas on selected soil types, cropping practices and slopes to provide base-line data which could then be extrapolated to other soil types using rainfall simulator data.

Despite the uncertainty of existing erosion rate data from the cultivated areas, this data and that from the grazing lands in the semi-arid areas, are far higher by one or two orders of magnitude than the natural erosion rates and the estimated soil formation rates from consolidated parent materials. These erosion rates are excessive and soil depth will be reduced at drastic rates unless effective conservation measures are introduced. These effects are likely to be most serious in semi-arid regions where soil depth, and hence the soil's available water capacity, is often one of, if not the most important of the soil properties affecting crop yields. In the absence of conservation measures in the semi-arid grazing lands, it has been estimated that 50% of the land in the Amboseli basement areas will be stripped of its soil cover within 50 to 125 years. Moreover, there is evidence that soil erosion rates are accelerating for both grazing and cultivated lands in some parts of Kenya.

If cropping and conservation practices are introduced to limit soil losses from cultivated land to the tolerable soil loss values used in the USA, there will for many soils still be a decline, though at a slower rate, in the productivity of the land. Thus for a soil of 120 cm rooting depth there would be a 20% reduction in depth within 350 years. This slow but steady decline in productivity raises certain ethical and moral issues. To what extent are we responsible for conserving the soil for future generations? For the next 5, 10, 20 generations or for how long? Our decision on this issue will of course influence the intensity and stringency with which soil conservation measures must be implemented.

In order to minimise soil losses it is suggested that steep backslope terraces, and polyvinyl acetate under some circumstances, may be very effective in reducing soil losses from cultivated land in the semi-arid areas. However, more research is needed on the effectiveness of steep backslope terraces,

especially on steeper slopes, and on the economic feasibility of using polyvinyl acetate, and its persistence in soil under tropical conditions. In humid cultivated areas graded terraces will often be indispensable, but where detachment is the dominant process limiting erosion, further decreases in soil loss may be achieved by the incorporation of organic materials or the application of mulches to reduce detachability. Where the transportation capacity of overland flow is the limiting factor, soil losses may be diminished by ridging, the application of mulches or crop residues or by grass strips. However, the effectiveness of these measures on different slopes and on soils of different erodibility needs to be investigated.

REFERENCES

- Ahn, P.M. 1979. 'Microaggregation in Tropical Soils. Its Measurement and Effects on the Maintenance of Soil Productivity.' In Lal, R. and Greenland, D.J. (Eds.) Soil Physical Properties and Crop Productivity in the Tropics. Wiley and Sons, Chichester.
- Arnoldus, H.M.J. 1977. 'Predicting Soil Losses due to Sheet and Rill Erosion,' FAO Conservation Guide No.1 pp. 99-124, FAO, Rome.
- Barber, R.G.; Moore, T.R. and Thomas, D.B. 1979. 'The Erodibility of Two Soils from Kenya'. Journal of Soil Science, 30, pp 579-91.
- 1979. 'The Influence of Polyvinyl Acetate and Polyvinyl Alcohol on the Runoff and Soil Losses from a Highly Erodible Soil from the Semi-Arid Areas of Kenya.' E. Afr. Agric. For Journal. 44 (2) In Press.
- & Thomas, D.B. 1981. 'Infiltration, Surface Runoff and Soil Losses from a High Intensity Simulated Rain Storms in Kenya.' Report to FAO, Rome. Faculty of Agriculture, University of Nairobi.
- & Moore, T.R. 1981. 'Studies on Soil Erosion and Runoff, and Proposed Design Procedures for Terraces in the Semi-Arid Arable Areas, of Machakos District, Kenya'. In Morgan R.P.C. (Ed.) Soil Conservation, Problems and Prospects. Wiley and Sons, Chichester.
- and Van Eijsbergen, A.C. 1981. 'A Proposed Model to Predict the Development of Level Bench Terraces from Steep Backslope Terraces.' J. Ag. Eng. Res. 26 pp. 271-76.
- Bennett, H.H. 1939. Soil Conservation. McGraw Hill, Inc. New York.
- Dunne, T. 1974. Suspended Sediment Data for the Rivers of Kenya. Report to the Ministry of Water Development, Nairobi.
- & Ongweny, G.S. 1976. 'A New Estimate of Sedimentation Rates on the Upper Tana River,' Kenyan Geographer, 2, pp. 20-38.
- 1977. Intensity and Controls of Soil Erosion in Kajiado District, Kenya. Consultancy Report, Kenya Wildlife Management Project, Food and Agriculture Organisation, Nairobi.
- ; Dietrich, W.E. and Brunengo, M.J. 1978. 'Recent and Past Erosion Rates of Erosion in Semi-Arid Kenya'. Z. Geomorphol. Suppl. 29, pp. 99-100.

- _____ 1979. 'Sediment Yield and Land Use in Tropical Catchments'. J. of Hydrol. 42, 281-300.
- Edwards, K.A. 1979. 'Regional Contrasts in Rates of Soil Erosion and their Significance with Respect to Agricultural Development in Kenya'. In Lal, R. and Greenland D.J. (Eds.) Soil Physical Properties and Crop Production in the Tropics. Wiley and Sons, Chichester.
- Government of Kenya, 1978. Marginal/Semi-Arid Lands Pre-Investment Inventory Report No. 1. Analysis and Project Identification.
- Harris, P.J. 1982. Personal Communication.
- Bruce-Okine, E. and Lal, R. 1975. Soil Erodibility as Determined by a Raindrop Technique. Soil Science 119, pp 149-57.
- Dowker, B.D. 1963. Rainfall Reliability and Maize Yields in Machakos District, E. Afr. Agric. For J. 28, 134-38.
- Kamau, N.R. 1981. A Study of Mass Movements in Kangema Area, Muranga District, Kenya. Postgraduate Diploma Soil Conservation Report. Faculty of Agriculture, University of Nairobi.
- McCormack, D.E. and Young, K.K. 1981. 'Technical and Societal Implications of Soil Loss Tolerance'. In Morgan, Op.Cit.
- Moore, T.R. 1979. 'Land Use and Erosion in the Machakos Hills', Ann. Ass. Am. Geog. 69, pp 419-31.
- Ongweny, G.S. 1979. 'The Hydrology of Sediment Production Within the Upper Tana Basin in Eastern Kenya. Proceedings of the Canberra Symposium, December 1979'. IAHS-AISH Publ. No. 128, pages 447-457.
- Othieno, C.O. 1975. 'Surface Rainoff and Soil Erosion on Fields of Young Tea'. Trop. Agric. (Trinidad) 52, pp 299-308.
- Smith, R.M. and Stamey, W.L. 1965. Determining the range of Tolerable Erosion. Soil Sci. 100, 414-424.
- Smith, R.M. and Yates, R. 1968. Renewal, Erosion, and Net Change Functions in Soil Conservation Science. Trans. 9th. Int. Congr. Soil Sci. Vol. 5, Paper No. 77.
- Sombroek, W.G. 1980. Legend of Exploratory Soil Map of Kenya. Int. Comm. No. 22. Kenya Soil Survey, Nairobi.
- Songambele, S.I. The Effects of Filter and Mud and Factory Ash on Some Physical, Dynamic and Chemical Properties of Sugarcane Soils from Kilombero, Tanzania, M.Sc. Thesis, University of Nairobi. In Preparation.

Tefera, F. 1981. An Evaluation of the Applicability of the Consistency C_{5-10} Index and Water Drop Method for Predicting Crusting, Runoff and Soil Losses for Some Kenya Soils. Postgraduate Diploma Soil Conservation Report. Faculty of Agriculture, University of Nairobi.

——— 1982. Personal Communication.

Thomas, D.B.; Edwards, K.A.; Barber, R.G. and Hogg, I. 1981. Runoff, Erosion and Conservation in a Representative Catchment of Machakos District, Kenya. In Morgan, Op. Cit.

Thomas, D.B., Barber, R.G. and Moore, T.R. 1980. Terracing of Cropland in Low Rainfall Areas of Machakos District, Kenya, J. Agric. Eng. Res. 25, pp 57-65.

Wischmeier, W.H. and Smith, D.D. 1978. Predicting Rainfall Erosion Losses - a Guide to Conservation Planning. U.S. Dept. Agric. Handbk No. 537.

Young, A. and Harris, P.J. 1976. Preliminary Investigation into the Biodegradability of Polyvinyl Alcohol and Polyvinyl Acetate. Med. Fac. Landbouww. Rijksuniv. Gent 41/1.

Fig.1 RELATIONSHIP BETWEEN AGGREGATE DETACHABILITY AND AGGREGATE MOISTURE CONTENT AFTER 16 HOURS EQUILIBRATION FOR A EUTRIC NITOSOL

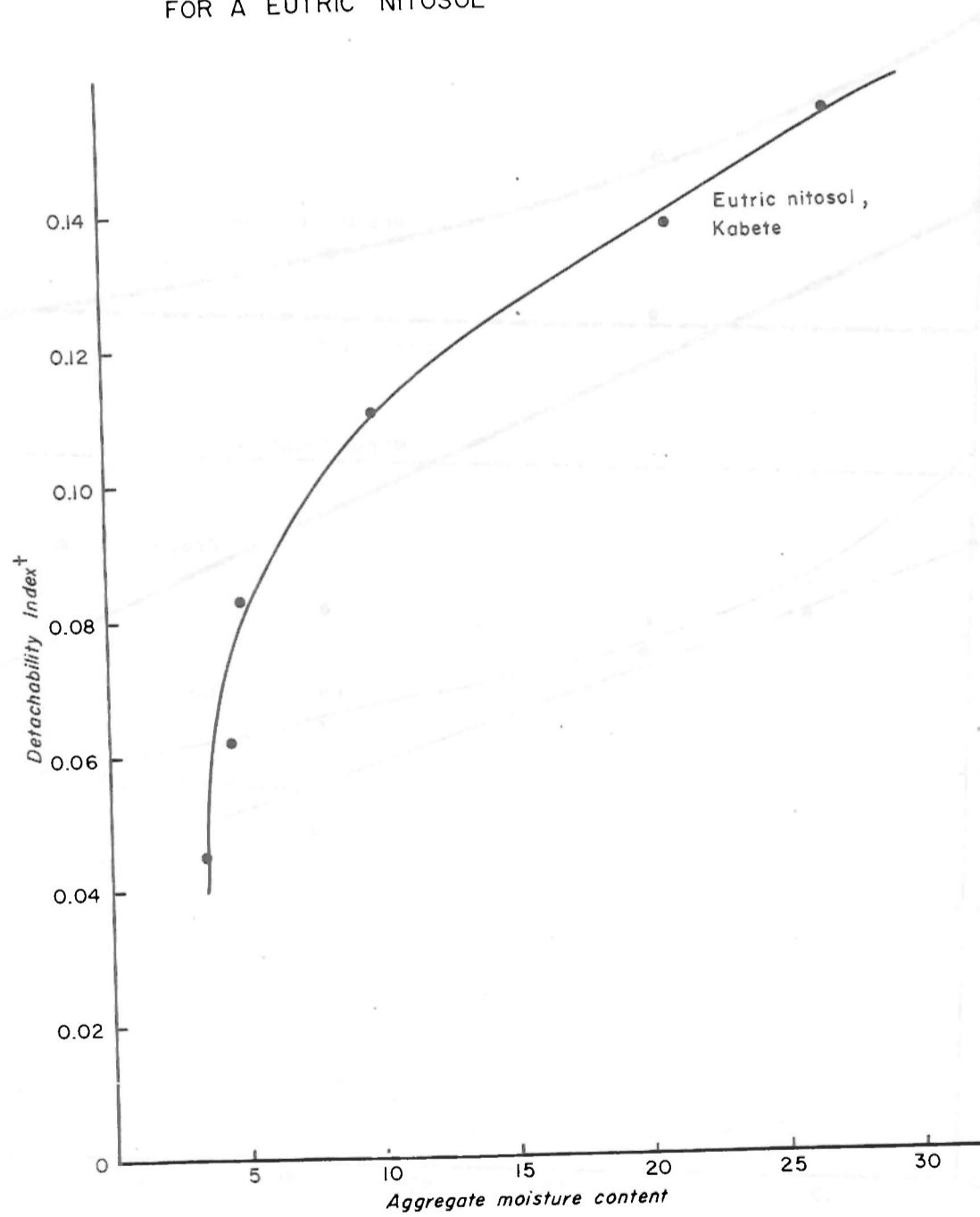

[†]Given by the reciprocal of the number of water drops required to disperse the aggregate

Source: Tefera, 1981

Fig.2 MOISTURE CONTENT DRAINAGE CURVES

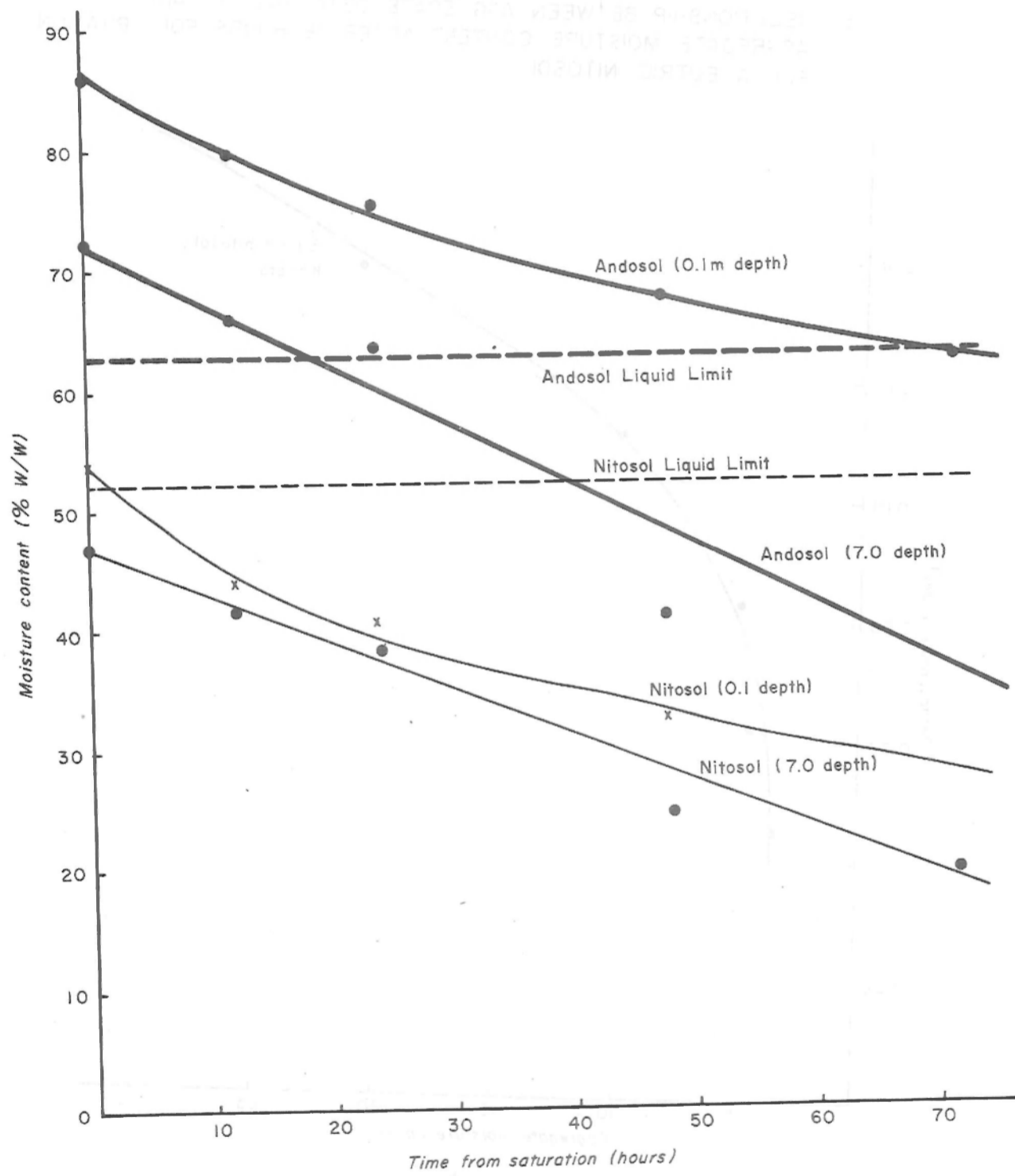

Source : Kamau, 1981

Fig. 3 SIMPLIFIED RELATIONSHIP BETWEEN SHEAR FORCE AND SHEAR STRENGTH OF A SOIL MASS

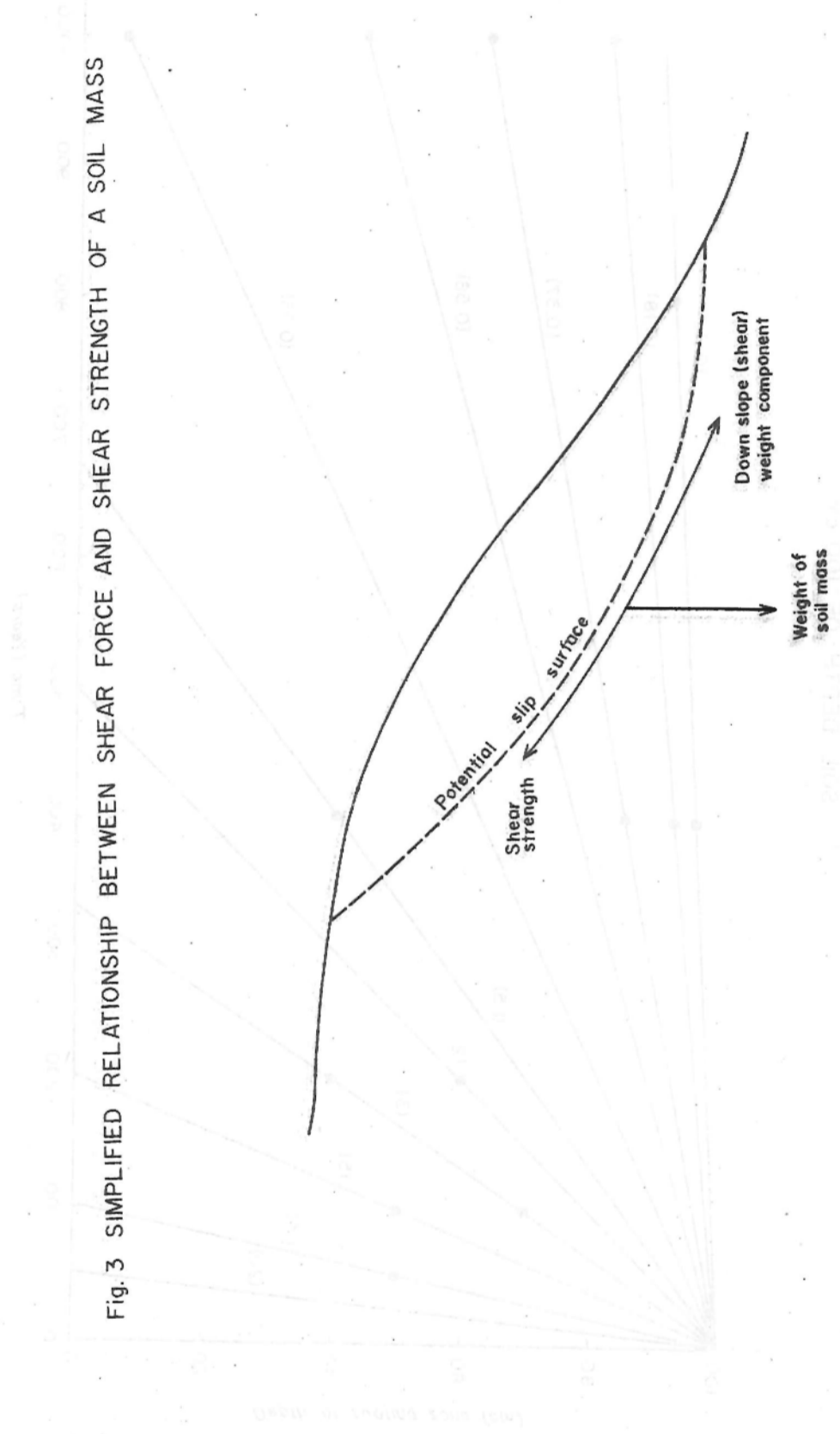
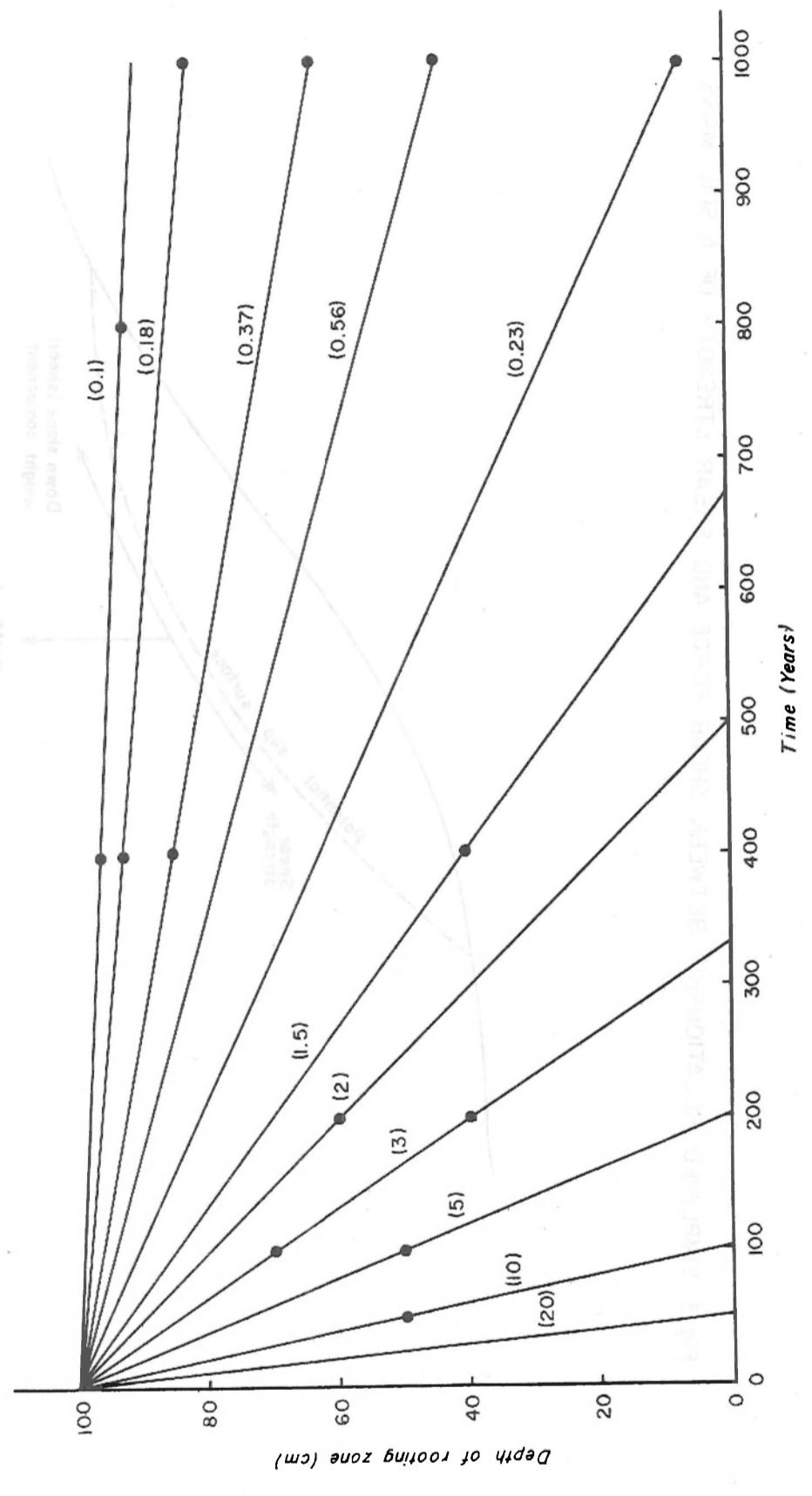

Fig. 4 DECREASE IN SOIL DEPTH WITH TIME FOR DIFFERENT RATES OF SOIL LOSS AND AN INITIAL SOIL DEPTH OF 100 cm



Figures in parentheses represent erosion rates (mm/yr); the rate of soil formation is assumed to be negligible.

FIG. 5 The initial steep backslope terrace and the derived level bench terrace.

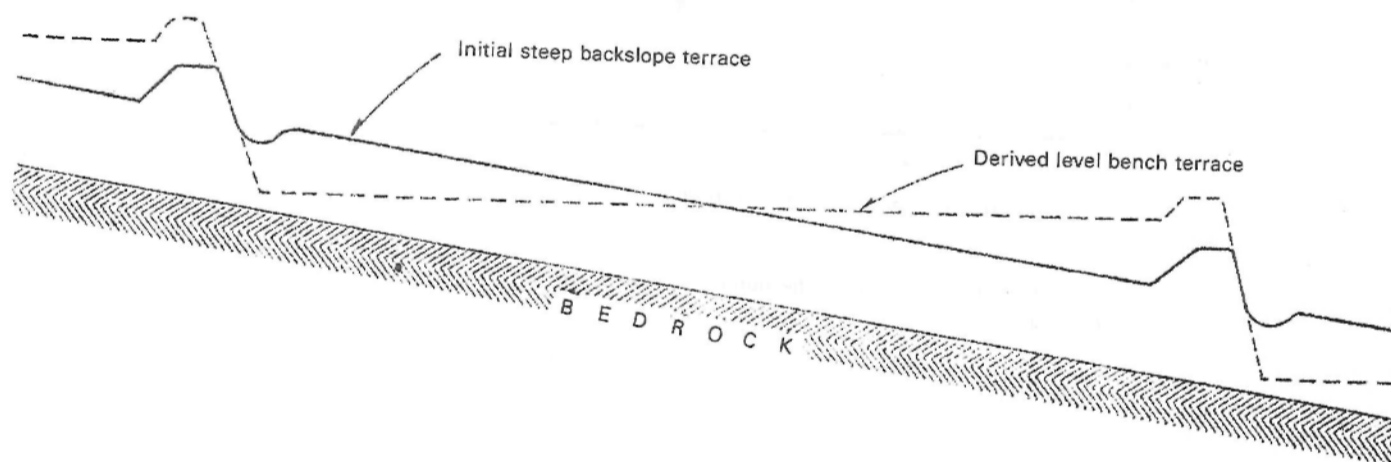
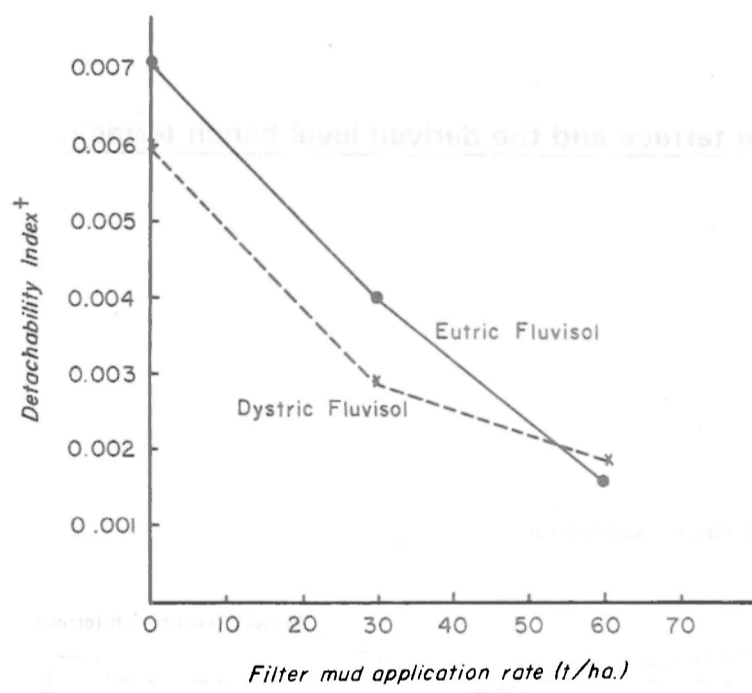

Fig.6 INFLUENCE OF INCORPORATED FILTER MUD
AGGREGATE DETACHABILITY



† Given by the reciprocal of the number of water drops required to disperse the aggregate

Source : Songambele , 1982

THE EROSION MONITORING PROGRAMME OF
THE NATIONAL ENVIRONMENT
SECRETARIAT

By

L. A. Lewis
National Environment Secretariat
Nairobi.

In July, 1981 the Natural Resources Management Division of the National Environment Secretariat began the initial stage of developing a programme to assess land degradation within Kenya. The first phase in this monitoring programme is concentrating on estimating the amount of soil loss as well as determining the environments in which major erosion occurs. The ultimate objectives are to quantify the amount of erosion occurring, identify the general environmental settings in which erosion is a major problem, and to make this information available to any ministry concerned with ameliorating land degradation. A second objective is to develop a simulation technique to determine if proposed activities will be deleterious to the existing land resource base and, if so, what changes in land use plans might be suggested to minimize negative impacts (objective 3). It is the intent of the Secretariat that the data provided will be useful in designing general safe criteria for land use planning and legislative purposes.

The pilot area in Kenya where data are to be gathered for the development of the soil erosion monitoring is Kiambu District, Central Province. Given the relatively weak data base for this area, it was necessary first to develop criteria to determine whether in fact land degradation is occurring and, if so, to what degree. Six maps and tables of all of Kiambu District were compiled illustrating the distribution and variability of estimated soil loss under 'natural' vegetation conditions. These values are considered to represent tolerable soil loss levels for agricultural purposes.* These values imply that

* These maps are available in the National Environment Secretariat.

even under natural conditions the soil loss is high such that certain areas are prone to excessive sedimentation if reservoirs would be built in the catchment areas.

A reconnaissance of Kiambu District is under way examining the various environmental settings found in the area as well as to observe the state of soil erosion and conservation. Within each of the seven divisions, the division's agricultural officer and often the D.O. point out the problem areas from their perspectives. In addition conversations with the farmers add further insights into crop selection, conservation practices, as well as other factors affecting soil erosion. Preliminary measurements on some serious gully formations are being made during this phase including location, magnitude, and the apparent cause.

Some preliminary observations concerning land degradation that will be monitored during the 1982 long rains are: First, the impact of clearing ever increasing steep slopes for agricultural purposes. This trend is likely to continue to meet the needs of the rapidly growing rural population. Erosion is clearly accelerating due to the use of these marginal lands. Non-reversible change is likely to occur in some areas (For example the upper regions of Gatundu Sub-division) and the soil resource will deteriorate if present trends continue. Second, concomitant with the use of these steeper lands is deforestation. Third, almost all soil erosion resulting from agriculture is from sheet wash, but ever increasing gully erosion is occurring on rural lands due to runoff from roads. This relatively new problem appears to be accelerating. Data on this phenomenon will be obtained. One gully already measured has removed at least 1,972 cubic metres of good agricultural land and has resulted in severe depositional problems. Gully formation along footpaths is also a problem, but unlike those resulting from road construction, conservation is already noted in many parts of the district. Fourth, many of the cash crops are particularly prone to accelerate erosion if conservation is not practiced. For example, pyrethrum in Limuru and Lari Divisions appear to result in high soil losses.

Within Kiambu five automatic raingages have been installed to measure the amount, duration, and intensity of rains during 1982. In addition 28 soil traps are installed in all of the major environmental settings found in the area. The relations between crop, ground cover, precipitation, topography, soil, and conservation practices in affecting soil erosion are to be determined. By comparing the actual soil erosion being determined through the field work with the 'natural' soil loss values already obtained an assessment of land degradation will be developed. This phase of the project should be completed by December, 1982. The findings from the Kiambu study will then be applied to other areas in 1983. The Secretariat eventually intends to monitor land degradation nationally once the methodology for the assessment is completely developed.

THE DESIGN AND INSTALLATION OF RUN-OFF PLOT EQUIPMENT
FOR THE NATIONAL DRYLAND FARMING RESEARCH STATION,
KATUMANI, MACHAKOS

By

Larry G. Ulsaker
USAID Dryland Cropping Systems Research
Project
KARI, Muguga, Kenya.

INTRODUCTION

Runoff plot equipment was designed and installed at the National Dryland Farming Research Station (NDFRS), Katumani, Eastern Province, Kenya during 1980. The installation will facilitate a long term research program involving measurement of soil erosion and water runoff, investigation of the causes and mechanics of each, and evaluation of preventive measure.

After several decades of specialized research on soil erosion and conservation problems it has been found that there is no satisfactory substitute for runoff plots as they supply basic data which may be secured only by actual measurement of the quantities of soil and water lost by erosion and runoff, Kirkby and Morgan (1980)).

This account describes the design, construction, and installation of the runoff equipment. It will serve to document why and how the work was done as it was, which will be useful to those working on the Katumani runoff plots. It may also be of assistance to others planning to develop additional runoff research facilities.

There are as many ways to develop a runoff research site as there are sites (hundreds) because every site in use today is unique. The equipment design criteria will vary with the location soil type, land use, and climate of each site. Yet basic procedures have been developed to aid site selection, and methods of determining equipment design are established, Mutchler (1963). This publication reports how these were utilized in developing the runoff

plots at the NDFS, Katumani.

SITE SELECTION

Geographic Area and Soil Type. One of the objectives of this runoff site is to evaluate the influence of climate and soil conditions on erosion in the Machakos area. Therefore the site must be located on a prevailing slope of a major soil type. Fortunately, such a site exists on the NDFS. The well drained, deep, dark reddish brown, friable, sandy clay soil of undulating uplands, on which the site is located, was developed on biotite and banded gneisses and occurs extensively in broadly scattered patterns throughout the area. It is classified as a chromic luvisol by the FAO/UNESCO (1974) soil classification system, or as an oxic paleustalf by the USDA Soil Taxonomy (1975) system. Siderius and Muchena (1977) concluded that crop research results derived on the NDFRS may be extrapolated to the medium potential areas of Eastern Province, though only for areas with similar rainfall distribution and altitude. Considering these restrictions plus that of soil type the crop research results may still be extrapolated to an area of over 100,000 hectares according to the Consortium for International Development, Pre-investment Inventory (1978).

Another objective is to compare the effects of different agronomic practices on erosion and water runoff. Consequently, the plots must accommodate statistical comparison, which requires that all plots have comparable slopes, soils, history, etc., to minimize variables other than those being studied.

Topographic Considerations. When the geographic area and soil type have been determined, it is desirable to select an area of uniform slope which represents the upper half of the percent slope range for the chosen soil type.

Careful inspection of over 240 hectares on the station failed to reveal a site with uniform slope, soil type, and history that was large enough to accommodate 16 runoff plots. Therefore,

the number of plots was cut to 12. In the United States most of the first runoff plots were 72.6 feet (22 meters) long with widths in multiples of 6 feet (1.83 meters) to give multiples of $\frac{1}{100}$ acre in area. These dimensions were widely used for convenience in making calculations. Also new plots of the same length allowed more direct comparison with old plot data. A 10% slope had been selected earlier because a considerable portion of this soil type occurred on that gradient as well as much of the surrounding cultivated area. To develop a site on a 10% slope that could accommodate 22 meters long plots required plowing out an old terrace. Avoiding such extensive surface soil disturbance was considered more important than being able to compare results directly with old data, at least for the time being. Consequently the plots are currently 10 meters long.

Plot width has little relation to soil loss per unit area on plots cultivated up and downhill and a three meter wide plot will accommodate five 60 cm rows, which is adequate for most research purposes. In many of the earlier plots, rows were planted along the contour. It soon became recognized however, that contour field management cannot be simulated in runoff plots because of complete balking within small plots and little concentration of row water, Mutchler (1963). Therefore most runoff plots are now planted up and downhill, and quantitative data are adjusted for effectiveness of contour-farming.

Considerable area is required below the plots for the measuring equipment (runoff collecting tanks). Placing the equipment further down the slope will reduce the excavation necessary to maintain adequate head. But the possible sites available and experimental objective, a topographic map on a 3 meter grid with a 0.5 meter contour interval was made. It would have been desirable to overlay a soil map on the topographic map, but there was no map available and arrangements could not be made to conduct another detailed soil survey of the area as well as design, fabricate, and install the runoff equipment before the approaching short rains (October, 1980). In retrospect, it would have been prudent to take the time for another detailed

soil survey, as other factors delayed installation until just prior to the long rains (March, 1981).

The farm manager for the NDFRS, Katumani, provided the following history of the site:

It was first cleared and plowed in 1958. Although not recorded it is assumed the terraces were constructed at the same time.

| | |
|--|------------------|
| 1957 - 1958 (October) Rains | Cleared |
| 1958 Long (April) Rains | Catch Crop |
| 1958 - 1959 Short Rains thru 1961 Long Rains | Grass |
| 1961 - 1962 Short Rains thru 1964 Long Rains | Cropped |
| 1964 - 1965 Short Rains thru 1968 Long Rains | Grass |
| 1968 - 1969 Short Rains thru 1974 Long Rains | Cropped |
| 1974 - 1975 Short Rains | Beans |
| 1975 Long Rains thru 1975-1976 Short Rains ... | Cropped |
| 1976 Long Rains | Sorghum |
| 1976 - 1977 Short Rains thru 1978 Long Rains | Pasture |
| 1978 - 1979 Short Rains | Maize |
| 1979 Long Rains | Pasture |
| 1979 - 1980 Short Rains | Cropped |
| 1980 Long Rains | Beans |
| 1980 - 1981 Short Rains | Completed |
| | Installation of |
| | Runoff Equipment |
| 1981 Long Rains | Maize |

In some instances, the specific crop was not recorded nor were the fertilizer application rates, yields, or other agronomic data.

EQUIPMENT DESIGN

Although no two runoff sites are the same, the basic equipment always consists of a plot boundary to prevent water and soil from entering or leaving the plot; a collector which serves as a weir at the end of the plot; a conveyance channel to handle the flow of soil and water; a sludge tank to contain the soil sediment and water; a multislot divisor with a precision plate

to accurately measure out a portion of the overflow from the sludge tank; and one or more aliquot tanks to contain the measured overflow. Many researchers install small, removable intertanks directly below the inflow spout of the sludge and aliquot tanks. This greatly reduces the time and labour required to sample and cleanup after small storms and improves the accuracy of volume measurements.

The equipment must collect the runoff and soil loss from the plot and hold a measured portion for measurement and analysis. Generally, three basic types of measurements are required to determine the amount of soil erosion, sediment movement, and sediment deposition: (1) measurements of sediment in surface runoff from small experimental plots, (2) measurement of the eroded area to determine the volume of material removed, and (3) measurements of the volume and density of sediment deposits. The size and capacity of the equipment are determined by the anticipated maximum rate and amount of runoff and sediment to be sampled. For equipment design purposes, the storage required for runoff and soil loss is estimated by using 100 percent of the 24-hour duration rainfall amount expected once in 100 years. Mutchler (1963) acknowledges that runoff rarely equals 100 percent of the rainfall, but feels that it is safest for figuring the storage capacity required. The maximum 24-hour rainfall amount recorded at Katumani between October, 1956 and February, 1982 is 100mm.

An estimate of soil loss is also needed in figuring the design volume for storage. Soil loss measurements for the marginal lands of Kenya have not been determined, but the Consortium for International Development (1978) utilized the universal soil loss equation (USLE) to estimate soil loss in the districts of Machakos and Kitui. The estimate for an 8 percent, 60 meter slope under continuous maize with residue removed was 114 tons/hectare/year.

Plot Boundaries can be made from earth ridges, wood or asbestos - cement planks, sheet metal strips, etc. Each has advantages and disadvantages. The author has experienced good results

with 26 ga. sheet metal strips 2.5 meters long x 22 cm. wide. They can be handled by one man and easily removed when cultivation of the plots is necessary. Two matched holes are drilled in the ends of each strip so they may be bolted together, making them watertight. They are placed on edge along the plot boundary and pounded in about 8 cm. - deep enough to prevent piping and tunneling by rodents. A little soil is then heaped up against the outer face of the strips to increase their stability and prevent seepage. Still, periodic checks during the rains are essential to eliminate leaks and seepage.

The Runoff Collector can be made of various materials and designs. Sheet metal construction is preferred to concrete so the level can be adjusted to the level of the plot as erosion occurs. An endplate of galvanized steel furnishes a stable attachment for the collector and blocks off the plot end. It should extend at least 20 cm. below the bottom of the collector trough. The collector and endplate are designed to reach across the entire 3 meter width of the plots. For wider plots, it is best to concentrate the runoff before collecting it.

This collector and endplate were made from 26 ga. galvanized sheet metal. The collector is 25 cm. wide and 35 cm. deep as illustrated;

Collector Trough

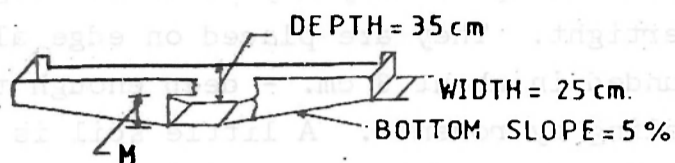

NOTE: M; is equal to height of conveyance channel (25cm).

The width must be enough to form an efficient channel and allow easy cleaning. The bottom slope should be a minimum of 5 percent, but can be more, depending on the overall length of the trough and the required depth. The latter depends on whether a rate measuring flume is used or whether the runoff is conducted directly to the sludge tank. Rate measuring flumes enable a runoff hydrograph to be made from erosion experiments but are more complicated to design, maintain, calibrate; and present problems of measurement inaccuracy due to sediment deposition in them. When no rate measurements are taken, the collector depth is based on the size of the conveyance channel needed to carry the runoff load.

The collector trough is covered with a 2.5 cm mesh screen to help keep field trash out of the system. A sheet metal cover fits over the top to prevent rain from entering.

The Conveyance Channel must be designed to handle a minimum velocity of 2 f.p.s. (0.61 m.p.s.) at about 20 percent of the largest flow expected. This ensures nonsilting velocities throughout most of the range of flows encountered. The largest flow expected is estimated to be .0424 cusec. (1.2 l/s).

When the above requirement for minimum velocity is used, the conveyance channel must be placed on a supercritical slope. Thus, the design problem resolves into a calculation of capacity governed by entrance conditions and slope requirements to maintain a minimum velocity. Since the flow goes through critical depth, the channel depth at entrance must equal critical depth plus half the hydraulic depth plus freeboard as in the case of an open conduit.

For a rectangular channel, the total depth (M) is
$$M = d_c + \frac{D}{2} + G$$

where d_c = critical depth

D = hydraulic depth = d_c for a rectangular section

G = freeboard

Critical depth is dependent on flow rate, so an estimate of runoff rate is used to calculate critical depth from the equation:

$$d_c = \left(\frac{Q^2}{b^2 g} \right)^{\frac{1}{3}} = \left(\frac{.0424^2}{.49^2 \times 32} \right)^{\frac{1}{3}} = \begin{matrix} .063\text{ft} \\ (1.9\text{cm}) \end{matrix}$$

where Q = flow rate = .0424 cusec (1.2 l/s)

g = gravity = 32ft/s² (9.81m/s²)

b = channel width = .49ft (15 cm)

The freeboard (G) is approximately 10% of the waterdepth, so

$$G = \frac{1}{10} \left(d_c + \frac{D}{2} \right) = \frac{1}{10} \left(.063 + \frac{.063}{2} \right) = \begin{matrix} .0095\text{ft} \\ (0.28 \text{ cm}) \end{matrix}$$

Then using the first equation to find M

$$M = d_c + \frac{D}{2} + G = .063 + \frac{.063}{2} + .0095 = \begin{matrix} .104\text{ft} \\ (3.12 \text{ cm}) \end{matrix}$$

This M is the channel depth necessary to prevent ponding in the plot. As it could be desirable to make the plots much larger in the future, the channel depth was increased to 25 cm.

Sludge Tank Storage capacities vary greatly with location soil type, land use and climatic conditions. Brakensiek, Osborn and Rawls (1979) report that sediment rates as high as 110 tons per hectare have been recorded from single runoff events and that the bulk densities of the trapped sediment ranges from 641 to 1,602 Kg/m³. The bulk density of the surface soil at the Katumani runoff site is 1,220 Kg/m³.

Assuming a maximum annual soil loss of 114 t/ha. and that the sludge can be emptied after a storm causing half this loss, then the required capacity is .14m³. To allow for plot enlargement and storage space for water, a sludge tank with .78m³ capacity

was designed to be made with 25 ga. metal, 1.82 x .76 x .60 meters with rounded ends and a top.

The major function of the sludge tank is to retain and store all the heavy soil material, passing only a mixture of suspended sediment to the multislot divisor. High entrance velocities from the runoff plot will cause turbulence in the sludge tank. This is reduced by placing two screens across the flow through the sludge tank, thereby increasing deposition. The screens also keep trash, snakes, etc. from clogging the divisor. They don't extend to the tank bottom and freeboard is allowed at the top to insure flow even if the screens do become filled with trash. The screen near the entrance is of 2.5 cm. mesh and the second is 1.3 cm. mesh. Both screens are removable for easy cleaning of the tank and the tank bottom is fitted with a drain plug.

The Multislot Divisor is a device for taking an aliquot of runoff water. It is based on the premise of a uniform horizontal flow velocity throughout the head variations. The essential part is the slot plate which contains 9 slots 2.54 cm wide x 20.32 cm high with a capacity of 1.5 c.f.s. (42.5 l/s). Various other slot plate designs exist with capacities ranging from .09 to 4 c.f.s. (2.5 - 113.2 l/s).

As the runoff flows through the slots, it is divided into equal parts. The portion discharged by the centre slot is retained in the aliquot tank. The multislot divisor is one of the best sampling units available for quantitative measurements of runoff and with careful construction and installation, the divisor ratio is accurate to about 1 percent for a runoff period.

The use of a sludge tank contributes to the success of the multislot divisor since the heavier soil drops out in the sludge tank. Hence the divisor only has to handle the suspended silt load. An entrance arrangement to the divisor (as illustrated) ensure suspended load mixing.

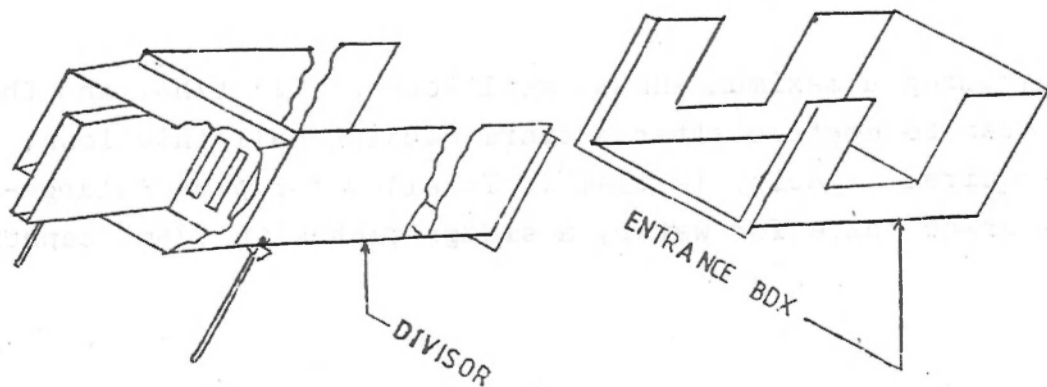

The detailed specifications and plans for the multislot divisor that were followed by the contractor are included in Mutchler (1963).

It is important to select a good contractor and work closely with him during construction of the equipment, especially the multislot divisor. One who has a machine for punching the slot plate will achieve slot plate similarity much easier than one who must saw and shape to the required tolerances. For example, the slots and precision plate should not deviate from a straight line by more than 0.13 mm. and it is best if they are stainless steel. The contractor should be an excellent welder experienced in working with stainless steel, as the precision plate has to be electrically spot welded to the slot plate. Also all welded seams and soldered joints must be watertight. All inside surfaces should be smooth with no dents, warps, blemishes, solder or tool marks. Good machine shop practices are required in the fabrication and assembly of all the equipment so the closer one works with the contractor, the better.

The Aliquot Tank stores that portion of the runoff discharged by the center slot of the multislot divisor. It is made of 26 gauge galvanized metal, 1.5 meter diameter and 1 meter deep with a storage capacity of 2,640 litres. Like the sludge tank, it is coated with bitumen, fitted with a drain plug, and a 72 litre can is set under the inlet to catch small flows.

Covers are necessary for each piece of equipment to prevent precipitation from falling directly into the system. The collector cover is 26 ga. galvanized sheet metal. Those for the sludge and aliquot tanks are 26 ga. sheet metal; for the conveyance channel, 22 ga. galvanized sheet metal.

INSTALLATION OF EQUIPMENT

The essential features of any runoff plot installation include those required for acquiring accurate data and those for convenient operation. To insure adequate consideration of these features, the installation should be fully planned even before

making the site selection, as a runoff plot can be designed for almost any site topography.

The downslope topography dictates the amount of excavation and type of drainage required for the equipment. The ideal situation is where the slope allows placement of the tanks close to the surface and the use of ditches to drain away runoff waste. This was not possible at Katumani, as the space between the bottom of the plots and the next terrace was barely adequate for the pits and service road. A service road along the line of equipment is essential to provide access with vehicles. The pits had to be close up under the plots and the conveyance channel leading from the plot to the sludge tank, a maximum of 4 meters long. Still, all the surplus runoff from surrounding areas cannot be disposed of in surface ditches. Four 7 cm diameter culverts, equally spaced, convey runoff under the road to four 2 m³ pits filled with rock. As in the conveyance channel design, the culverts had to be installed so the flow velocity is kept above 2 f.p.s. (0.61 m.p.s.).

The first step in installation is to establish the permanent plot corner markers with the aid of the topographic map and the survey stakes. As mentioned earlier, a minimum plot size of 3 by 10 meters was determined acceptable for the research objectives of this runoff site. Since the primary tillage treatments will be performed by ox-drawn implements, a 5 meter strip between each plot boundary was designed to allow turnaround space for the oxen. Half of this intermediate area next to a plot is cropped and treated in the same manner as the plot and in fact form part of the plot except for collection of runoff and measurement of yields. In the plot area, a good guide is to tolerate no more than plus or minus 6 cm irregularity from the average plane surface. Areas exceeding this irregularity will require smoothing, but this should only be done with the counsel of a soils man experienced in soil erosion work.

Next, the sites for installing the collectors, excavating the tank pits, digging the drainage ditches and constructing the access road with culverts and sump pits were staked out. The

downslope topography dictates the pit excavation depth which had to be calculated separately for each pit based on the elevation of the collector unit and the conveyance channel slope requirements. The elevation of the various equipment pieces should be recorded and checked annually to insure proper alignment and to maintain the runoff plot slope. Therefore a permanent bench mark was established in a non-cultivated area of the runoff site.

The sheet metal boundaries are easily pounded into the ground on cultivated plots. On pasture or sod plots, they may also be pounded in when the soil is wet. If they must be installed when the soil is dry and hard, it will help to use a jig made up of two planks spaced about 1 cm apart. Actually, a jig is helpful, under any condition, in keeping the boundaries aligned during installation. If necessary, steel round pegs driven vertically on either side of the strips every 2 meters or so will hold them upright. At the lower end of the plot boundary, the strips are slipped into 1 cm wide slots cut 15 cm deep in the ends of the collector end plate.

Upon completion of the boundary installation, earth is packed around the boundary-end plate joint and, in cultivated plots, around the outside of the boundaries to prevent leaks.

The Collector was welded to the end plate during fabrication to form one solid unit. Some researchers prefer to bolt the collector to the end plate after installing the latter. In either case, a trench wide enough to allow tamping from both sides of the end plate should be dug. It must be deep enough so the lip of the collector is just level with the soil surface. The trench may be 2 - 3 cm shallower than necessary and the end plate driven in to the proper depth, but sheet metal is easily deformed so this should be done carefully. In dry soil, the bottom of the trench can be softened with water. While digging the trench, stockpile the top soil then replace it last after tamping the end plate in solid with subsoil. If the collector is bolted to the end plate, the seams should be sealed with roofing cement.

The conveyance channel is designed to slip over the rectangular collector outlet and fit into the rectangular notch of the sludge tank. The seams of these two connections are sealed with roofing cement.

The conveyance channel length may be varied to allow placing the tanks nearer the ground surface. For example, if the minimum conveyance channel slope was 2.5 percent and the ground slope below the runoff plot was 10 percent, the tanks could be .23 meter nearer to the surface for every additional 3 meter length of channel used.

At Katumani the space below the plots barely allowed a 4 meter channel so the tanks had to be installed below the soil surface. This required deep excavation pits. Here also it is best to stockpile the topsoil so it may be spread over the subsoil after completing the excavation and forming the soil around the pit to prevent water from running in.

The sludge tank should be placed on a stable platform. This facilitates sampling the runoff and cleaning the tank without wading in the mud so much. Since this work is done after a rain, it is a wet, sloppy job at best. The tanks at Katumani are on platforms made of treated 2 x 6 in. boards nailed across cedar planks 4 x 4 in. The platforms are supported on sunken concrete blocks and the bottoms of the pits are covered with a 10 cm layer of gravel.

The multislot divisor unit functions with the floor level and the precision strip level. It should be bolted to the sludge tank in a semipermanent manner and positioned so that the top of the entrance box is level with the bottom of the inlet pipe as illustrated:

SLUDGE TANK AND MULTISLOT DIVISOR

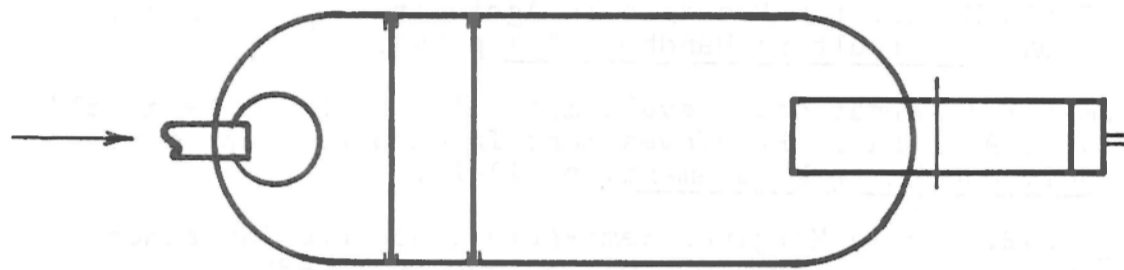

PLAN

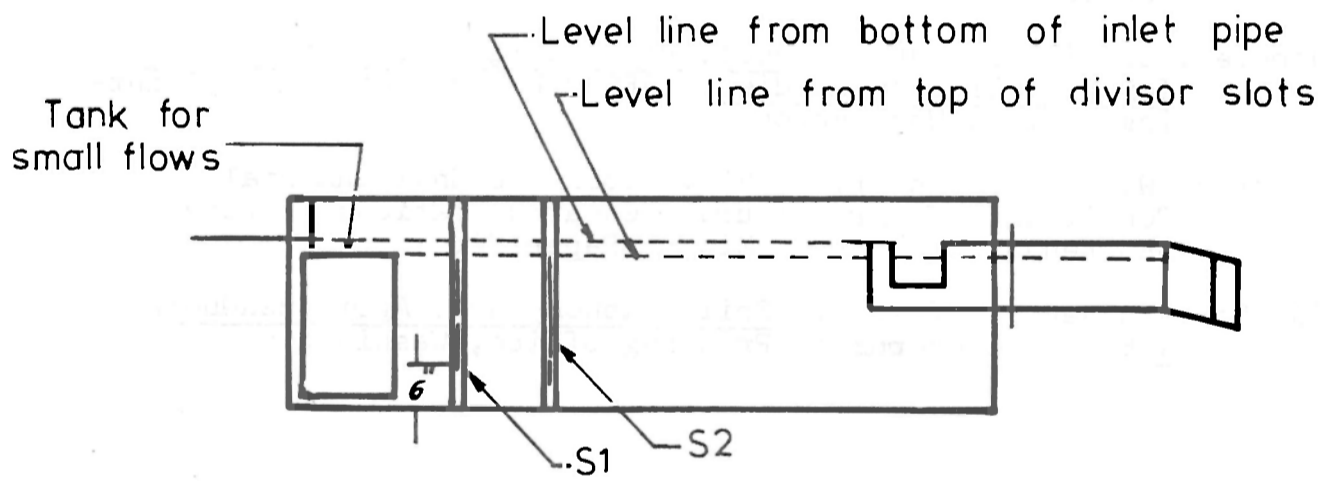

SECTIONAL VIEW

1/2 Mesh for S1 1/4 Mesh for S2

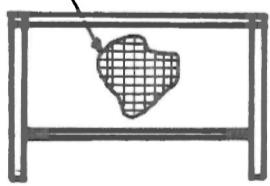

Screen

REFERENCES

- Brakensiek, D.L.; Osborn, H.B. and Rawls W.J. Coordinators. 1979. Field Manual for Research in Agricultural Hydrology. USDA. Agriculture Handbook 224 p.246.
- Consortium for International Development. 1978. Kenya Marginal/Semi-Arid Lands Pre-Investment Inventory. Report 4. Soil and Water Management. p. 12-20.
1978. Kenya Marginal/Semi-Arid Lands Pre-Investment Inventory. Report 10, Soil Science p. 30-34.
- FAO/UNESCO. 1974. Soil Map of the World Vol.1 Legend. UNESCO. Paris.
- Kirkby, M.J. and Morgan, R.P.C. 1980. Soil Erosion. John Wiley and Sons. p. 78.
- Mutchler, Calvin, K. 1963. Runoff Plot Design and Installation for Soil Erosion Studies. (ARS/USDA) US Government Printing Office, Washington.
- Siderius, W. and Muchena F.N. 1977. Soil and Environmental Conditions of Agricultural Research Stations in Kenya. NAL/Kenya Soil Survey Misc. Paper M5.
- USDA Soil Survey Staff 1975. Soil Taxonomy Scs. Agri. Handbook 436. U.S. Government Printing Office, Washington.

FIELD EXPERIMENTS ON SOIL EROSION IN AMBOSELI,

KAJIADO DISTRICT

By

Brian Aubry,
Department of Geological Sciences
University of Washington,
Seattle, U.S.A.

and

E. K. Wahome,
Kenya Rangeland Ecological Monitoring Unit,
Ministry of Environment & Natural Resources,
Nairobi, Kenya.

INTRODUCTION

Studies of soil erosion processes have mainly been conducted in agricultural areas in the technologically advanced countries and few experiments have been conducted in the arid and semi-arid regions (Dunne et al., 1980; Dunne, 1977). The Universal Soil Loss Equation, developed by the U.S. Soil and Water Conservation Service, has been shown to be of uncertain relevance in tropical areas, although it has been used with success as an index of soil erosion in Kenya in a study of the effects of woodfuel harvesting on soil erosion (Dunne et al., 1981). Although attempts have been made to calibrate it, serious gaps exist in our knowledge of soil erosion in countries where climatic and land use conditions differ from those existing in the developed countries. Therefore, careful studies are necessary, especially in the arid and semi-arid regions where rates of soil erosion have been shown to be exceedingly high, so that objective decisions about soil conservation measures in rangeland management can be formulated. Furthermore, we do not know a great deal about the degree to which various soil conservation measures reduce soil loss. Methods which are suited to field conditions are needed to examine both soil erosion processes and the effectiveness of soil conservation measures in the rangeland. This paper presents an improved methodology for providing quantitative data on surface runoff, infiltration capacity, soil loss and sediment transport under varying rainfall intensities

in areas of differing slope gradient, vegetation cover, soil type, and land use practice. We also present briefly some preliminary results of artificial rainfall experiments concerning spatial variability of infiltration capacity and the effects of vegetation cover, surface texture, and rilling on soil loss. This work is a continuation of work begun under a Ministry of Tourism and Wildlife consultancy in 1976 (Dunne, 1977).

STUDY AREA DESCRIPTION

The study area is situated to the North of Amboseli basin on Eremito Ridge in a belt of Precambrian granitic schistose basement rocks. The region receives 300 mm of rainfall per year and has a vegetation cover of grassland (ground cover of 5 - 75%) and bush grassland with patches of scattered bush (canopy cover of up to 40%) on the higher steeper hillslopes. The area is utilized by large herbivore population of domestic stock and wild game. The soils are sandy clay loams mostly 50 cm to 150 cm deep. The hillslopes have lengths greater than 500 m and only a small proportion have gradients greater than 0.10. The hillslopes have simple profiles and smooth surface with no rills or gullies on the upper several hundred metres. Rilled segments occur towards the lower ends of slopes.

PREVIOUS WORK

The original rainfall simulator experiments, which form a preliminary phase of this study, were concerned with controls of soil erosion in Kajiado District. The rainfall simulator used was designed for easy operation and maintenance under field conditions, and is well described in Dunne (1977) and Dunne et al., (1980). Briefly, it consisted of a wooden frame, 3.0 m high, which supported a single rail with a vertically mounted spray nozzle on a wheeled trolley. The nozzle was pulled rapidly back and forth, irrigating a plot 1.0 m to 1.2 m wide and 5 m long. Runoff and eroded soil were collected at the foot of the plot in a folded sheet metal trough with a 10% slope and a narrow outlet for convenient sampling.

The spray nozzle, operating at a height of 3.0 m, reproduced 60 to 70% of the kinetic energy of natural rainstorms and a median drop diameter 80% of those in natural storms.

The problems associated with this rainfall simulator were:

(a) The small plot size, which did not always allow for natural areal variabilities in vegetation cover and surface texture, and which, perhaps, allowed for lateral movements of subsurface moisture, producing infiltration rates which were slightly high.

(b) An imperfect reproduction of natural kinetic energy, which has been highly correlated with soil loss (Smith and Wischmeier, 1958; Stocking and Elwell, 1975).

(c) A non-uniformity of rainfall distribution.

(d) It provided no techniques for measurement of local sediment transport by overland flow or of the upslope and downslope components of aerial sediment transport by rainsplash.

Dunne (1977) found that the major controls of soil erosion were volume of runoff, vegetation cover, hillslope gradient, soil type, and animal trampling. Infiltration capacity was found not to vary with vegetation cover or degree of trampling in an obvious manner, though he was comparing data for different localities. The presence of a coarse sand lag, which accumulates on the ground surface as fine soil particles are washed out of the sandy topsoils, complicated results, especially in the Amboseli region. It was found difficult to develop a relationship between vegetative cover and soil loss because of these textual effects which became highly significant as vegetation cover declined. All previous experiments were conducted on unrilled plots.

EXPERIMENTAL METHODOLOGY

The present experiments are being conducted with a rainfall simulator which represents an improvement over that designed earlier. The aim of designing an improved rainfall simulator was to reproduce more closely the kinetic energy and uniformity of

natural rainstorms as they occur in tropical regions, and to increase the plot width and length without augmenting the logistical difficulties of performing experiments in remote areas.

The new rainfall simulator is slightly more cumbersome, but can be carried to an area on a small pick-up and moved around a hillslope by six people without dismantling. It includes components for simulating rainfall from a water supply and for collecting runoff from a bounded plot. The equipment consists of a wooden frame, 4.9 m high, supporting two parallel metal rails along which wheeled trolleys with vertically mounted spray nozzles are rapidly moved back and forth over the plot irrigating an area 6.0 m long and 2.5 m wide. Two nozzles are used instead of one in order to produce the effect shown in Fig. 1, i.e. increased uniformity of rainfall distribution on a widened plot. The nozzles used are the Veejet 80100 and 80150, the same used by the U.S. Soil and Water Conservation Service in the elaborate "rainulator" (Meyer and McCune, 1958), though our rainfall simulator irrigates from a greater height. The kinetic energy of rainstorms obtained are greater than 90% of those in natural tropical storms for the intensities employed, while the media drop size falls in the lower range of those in natural storms.

Water is supplied to the nozzles from two 500 gallon (2,250 l) tanks (if no local source of water is available) by a small petrol driven pump which suffices for an experiment that lasts one hour. Nozzle pressure is controlled by a return line which leads water back to the tanks connected at a valve junction along the outlet hose. Pressure remains constant during an experiment.

The plot is bounded by 15 cm metal strips driven firmly into the soil. Runoff and eroded soil are collected at the foot of the plot in an inclined trough, or, on rilled plots, by a concrete 'throat' installed in the channel below the plot.

Fig. 1 Veejet nozzle discharge vs distance from the center of the spray. Two nozzles spaced five feet apart produce an increased uniformity of drop distribution. The nozzle is moved out of the page to irrigate the Plot.. From Meyer (1958).

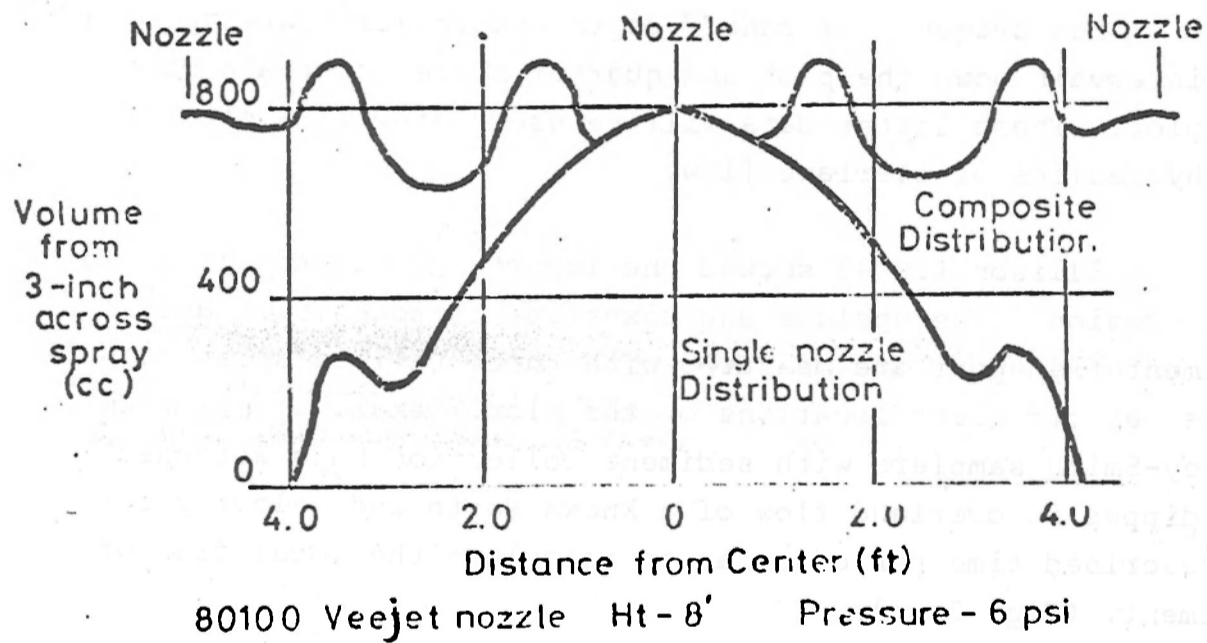

Discharge of runoff and sediment is measured continually during an experiment by repeatedly collecting and discarding runoff in a 1 litre sample bottle, noting the time to fill the bottle. At every two minute interval one litre runoff samples are retained for sediment production determination. Rainfall intensity is measured by an array of 21 rain gauges spaced uniformly on the plot. Infiltration capacity is calculated throughout the experiment as the difference between the constant average rainfall intensity and the runoff discharge rate for each two minute interval. The rate of soil loss per unit of runoff is obtained by filtering the collected runoff samples and dividing the weight of sediment by the time taken to fill the bottle.

Measurements of runoff depth and velocity are taken at 1 m intervals down the plot and quarter metre intervals across the plot. These latter data will be used later in a study of the hydraulics of overland flow.

Ellison (1944) showed the importance of rainsplash in soil erosion. The upslope and downslope components of aerial sediment transport are measured with three Ellison splash cans placed at different locations on the plot. Small 6 cm x 2 cm Helley-Smith samplers with sediment collection bags attached are dipped in overland flow of a known depth and velocity for a prescribed time period so as to calculate the local flux of sediment. (Fig. 2, 3).

RESULTS

Recent experiments have been performed on a single hillslope where gradient and soil type are relatively constant. The aim was to study spatial variation in infiltration rates and the effects of vegetation cover, surface texture, and rilling on soil loss. The results emphasize the complexity of processes of soil erosion in this area, the controls of factors not present in studies conducted in other regions, and the need for continuing work. Six sets of experiments were performed on six plots with vegetation covers of 0%, 5%, 10%, 35% and 75%. The latter two plots were clipped down to 19% and 35% basal cover,

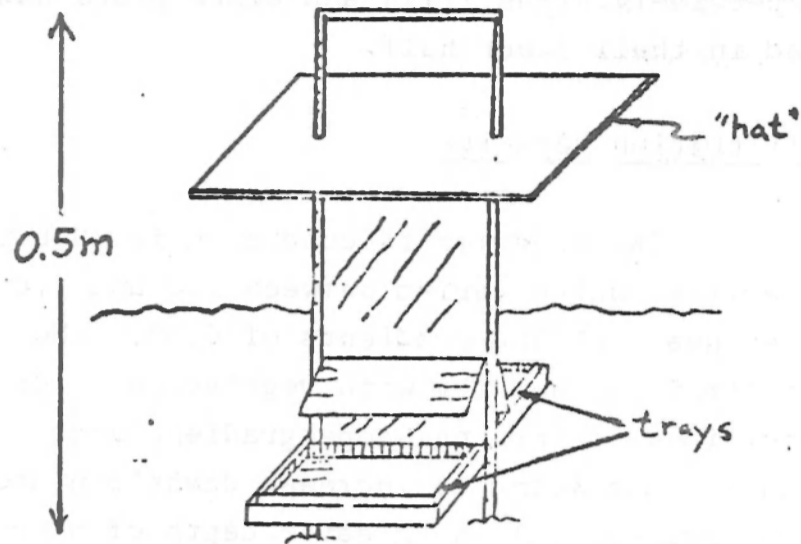

Fig. 2. Ellison Splash Can. The upslope and downslope components of sediment transport by rainsplash are deposited in the trays on either side of the vertical separation wall. The horizontal "hat" prevents raindrops from falling directly into the trays. The splash can is positioned with the vertical wall perpendicular to the direction of maximum slope.

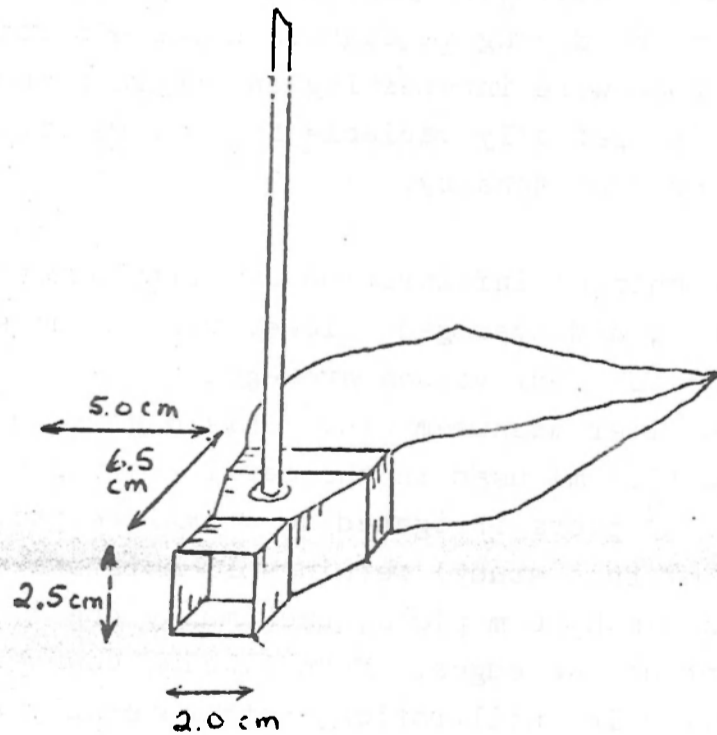

Fig. 3. Helley-Smith Sampler. The device is dipped into the runoff. It is oriented so that the flow enters the open end. Sediment is trapped in the bag while water is allowed to flow out.

respectively. The fifth and sixth plots had 0% cover and a rill head in their lower half.

Infiltration Capacity

The experiments conducted in 1976 yielded infiltration capacities which varied between 2.0 and 3.0 cm/hr for plots with cover near 10% and gradients of 0.02. (No correlation of infiltration capacity with vegetation cover was found under conditions of varying slope gradient and soil type.) Infiltration capacity was found to increase downslope and two explanations were offered: (a) The greater depth of overland flow provides a larger head to drive water into the soil; (b) Soil surfaces downslope are less subject to raindrop sealing as they are protected by the thick sheet flow. We have noted that soil characteristics vary markedly downslope: the soil colour changes, the sand/silt clay ratio increases and aggregation improves. (Recent experiments on rilled plots near the foot of the slope showed infiltration capacities, 25 - 50% greater than those close to the ridge.)

Experiments have been performed to examine the infiltration capacity with varying vegetation cover and root density. The results obtained were interesting and suggest that infiltration capacity is spatially variable but not related in a simple manner to cover or root density.

Measurements of infiltration capacity varied between 0.7 and 4.0 cm/hr., and averaged a lower value than suggested by the 1976 experiments. Our values averaged 0.5 to 1.0 cm/hr. lower than the earlier measurements. This may be due to the small plot width (1.2 m) used in the earlier studies. We have noticed that 1.0 m² plots irrigated to stimulate production (another aspect of this study) retain soil moisture much less efficiently than 3 m by 6 m plots, presumably due to the high moisture gradient at the edges. More likely, however, is spatial variability in infiltration, both laterally and downslope. Plots from the earlier experiments were situated adjacent to each other for experiments on similar areas subjected

to different levels of artificial trampling. The present experiments were done on plots widely separated with different covers.

Results show that there is no significant correlation between cover and infiltration rate. At this point, it can be postulated that on these slopes infiltration is controlled by subtle changes in soil characteristics which are sometimes accompanied by marked changes in species composition. It was noted that soil in heavily vegetated areas showed lower concentrations of coarse particles. At this time a study is being initiated to examine spatial variability of infiltration more carefully. It is clear, however, that runoff, the major control of soil erosion, is not generated uniformly on these hillslopes.

The Cover Factor

An approximate relationship between ground cover and soil loss per unit of runoff was presented in Dunne (1977) and is reproduced in Fig. 4. Only the point for 12% cover came from Amboseli and in fact, this early study was unsuccessful in producing such a diagram for a single locality. Fig. 4 shows that soil loss is expected to decrease sharply as vegetation cover increases from 0 to 30%. Further increases in cover produce lower reductions in soil loss. The general form of the graph is in agreement with that predicted by the Universal Soil Loss Equation for cultivated lands in the U.S.A.

Recent experiments on a wide range of covers on a single hillslope in Amboseli produced the graph in Fig. 5. It shows that the dramatic upturn in soil loss at lower covers does not occur as expected. It was postulated that this was due to the effect of a surficial sand lag which acts to protect the soil from raindrop impact. On plots with covers of 5 and 10% the sand lag occurred over 50% or more of the plot area. On the 10% cover plot the surficial lag was removed with a brush. Soil loss rates then increased by 2 to 3 times generating the upper line in Fig. 5. Our data have been plotted with Dunne's data for 2 m wide trampled plots yielding a consistent relationship

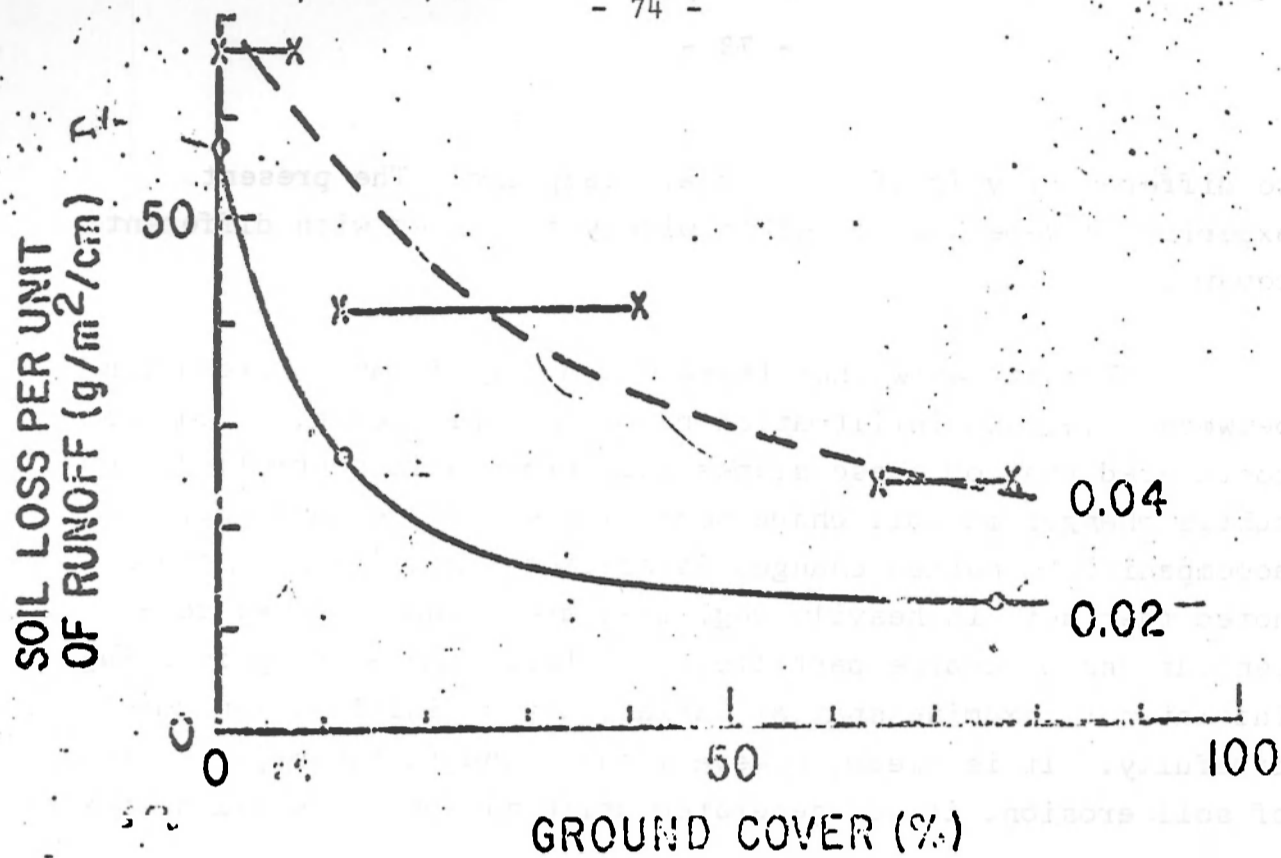

Fig. 4. Approximate relationship between soil loss and vegetation cover from Dunne (1977). Only the point for 12% cover is from Amboseli.

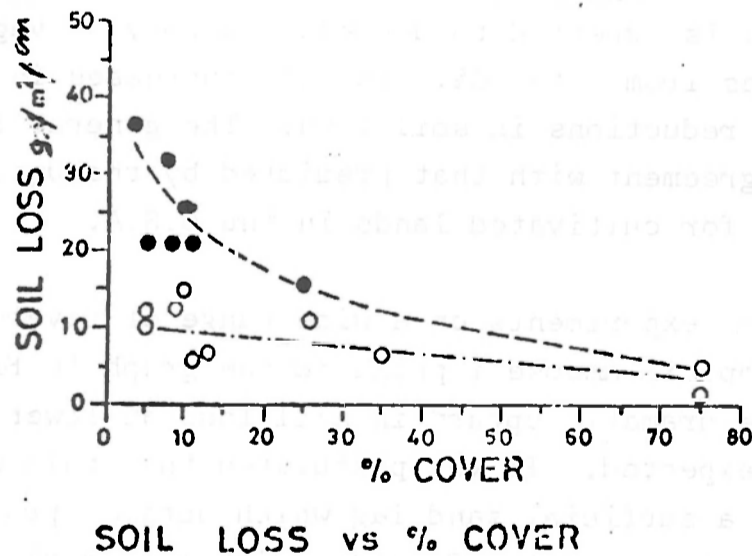

Fig. 5. Relationship between soil loss and vegetation cover for Amboseli on a slope of .02. The lower curve represents plots with an undisturbed surficial sand lag. The upper curve represents plots with the sand lag removed or disturbed by high levels of artificial trampling (Dunne, 1977). Since the graph makes use of data from experiments with slightly different plot widths, it should be taken as preliminary, but indicative of the protective effect of a sand cover.

similar to Fig. 4. (Although our plots are slightly wider than this so that the kinetic energy of the rainstorms was not identical, the data appear to be comparable.)

At high covers soil erosion remains at values relatively low. As cover decreases, erosion increases slightly but the protective effect of the surficial sands becomes highly significant. If the surface lag is disturbed mechanically so that fine particles are brought to the surface, soil loss rates increase dramatically. When the surface texture effect is removed the vegetation cover vs. soil loss graph takes on a form similar to that suggested by the USLE.

Reid (1981) has shown that inclusion of a ground surface factor in the USLE produced good agreement with soil loss rates for gravel surfaced roads in Washington State, U.S.A. Inclusion of such a factor, called the B-factor, for the portion of the surface which is not covered by stones or dead wood, i.e., the percent of the surface which is available for erosion, could be useful in predicting erosion rates for Kenyan hillslopes. This is also suggested in a study of the effects of woodfuel harvest on soil erosion by Dunne et al., (1981). In this report it was suggested that 'the fraction of the soil surface covered by immobile gravel or large pieces of wood could be altered due to woodfuel harvest or by the emergence of a gravelly subsoil on severely eroded sites.'

Rill Studies

Experiments on plots with rill heads have been started on the lower portions of the slope. As they have just begun they will not be discussed here in detail. The rill studied was approximately 9 cm deep, 30 cm wide, and extended half way up the plot where it died out in several directions in a fingering pattern. The persistence of rills seems to be controlled by the relative importance of rain splash degradation of surface irregularities vs. sheet wash incision, a notion suggested by Meyer (1975), Walker et al., (1978), and Dunne (1980).

The most striking feature of experiments on rills is the enormity of the increase in soil loss. Efficiency of erosion increases tremendously as water becomes channelized. Our preliminary experiments have shown that soil loss increased 10 to 20 times for similar rainfall intensities and runoff volumes for the rill plot as compared to unrilled plots. Sand and gravel are easily moved downslope when the channel is filled to the bank-full stage. Cobbles of 3 cm size have been seen to move sporadically.

CONCLUSION

This paper has introduced an improved system of rainfall simulation for soil erosion studies which is cheap, portable, and suited for use in remote areas. The equipment offers a technique for work in tropical areas where more information on local controls and processes of soil erosion is needed for effective decision making management. It also offers a workable method of evaluating in the field the effectiveness of various soil conservation measures and for predicting accelerated soil erosion in response to changes in land use. For example, plans for assessing the impact of wood-fuel harvesting using artificial rainfall experiments are planned for the near future. This will allow direct observation of the nature of changes following woodfuel harvest.

Preliminary data from the semi-arid regions have shown that infiltration rates can vary spatially by as much as five times, and seems to be controlled by local soil characteristics. Runoff is generated non-uniformly downslope and also laterally. Vegetal cover and surficial sand lags act similarly to keep erosion at relatively low values. Disturbance of the sand lag by moderate to high levels of trampling increases erosion by 2 to 3 times, although the sand lag is quickly re-established as fine particles are washed out. Rill formation increases erosion in the study area tremendously, depending upon the drainage density.

ACKNOWLEDGEMENTS

The authors wish to thank Mr. D.K. Andere, Project Manager, KREMU; Professor T. Dunne, Department of Geological Sciences, University of Washington, Seattle, U.S.A; Dr. G.S. Ongweny, Department of Geography, University of Nairobi; and Mr. M.O. Olang, Senior Range Ecologist, KREMU, for their encouragement and continuing support during this on-going study. Much appreciation is also extended to Mr. James Goodman for his assistance in designing the rainfall simulator, and George Francis Malile, Laura Pinato-Aubry, Charles Muchoki, Peter Maina, Frank Msafiri, and David Wambua for their field assistance during the experiments. The study is supported by KREMU and the National Science Foundation, U.S.A.

REFERENCES

- Dunne, T., 1977. Intensity and controls of soil erosion in Kajiado District, Kenya; U.N. Food and Agriculture Organization, Nairobi, 151 pp.
- Dunne, T., 1980. Formation and controls of channel networks; Progress in Physical Geography, Vol. 4, No.2.
- Dunne, T., Aubry, B., and Wahome, E.K., 1981. Effect of woodfuel harvest on soil erosion in Kenya. KREMU/Ministry of Energy publication.
- Dunne, T., Dietrich, W.E., and Brunengo, M.J., 1980. Simple and portable equipment for erosion experiments under artificial rainfall; J. Agric. Engng. Res., 25, pp 1-8.
- Ellison, W.D., 1944. Studies of raindrop erosion. Agric. Engng., 25. pp 131-6 and pp 181-2.
- Meyer, L.D., 1958. An investigation of methods for simulating rainfall on standard runoff plots and a study of the drop size, velocity, and kinetic energy of selected spray nozzles. Special report 81. Purdue Univ. Agric. Exp. Sta.
- Meyer, L.D., and McCume, D.L., 1958. Rainfall simulator for runoff plots. Agric. Engng., 39 (10), pp 644-8.
- Reid, L.M., 1981. Erosion from gravel surfaced roads in forests, Olympic Mts., Washington; M.Sc. thesis, Univ. of Washington, Seattle. U.S.A.
- Smith, D.D., and Wischmeier, W.H., 1958. Rainfall energy and its relation to soil loss; Amer. Geophys. Union Trans., 39, pp 285-291.
- Stocking, M.A., and Elwell, H.A., 1976. Rainfall erosivity over Rhodesia; Inst. of British Geographers Trans., New Ser. 1, pp 231-245.
- Walker, P.H., Kennel, P.I.A., and Green, P., 1978. Transport of a non-cohesive mixture in rainfall and runoff experiments, Soil Sci. Soc. Am. J., Vol. 42, 793-801.

THE ROLE OF SOIL SURVEYS AND LAND EVALUATION IN
ASSESSING SOIL EROSION HAZARD

By

F.N. Muchena
Kenya Soil Survey
National Agricultural Laboratories
Nairobi.

INTRODUCTION

Soil survey is the practical wing of pedology which is the study of the genesis of soils. It indicates the location and extent of each kind of soil. From the soil map, interpretations can be made to show the various alternatives for safe use of the soil. Soil mapping can enable comparison to be made between results gained in different areas of survey. It can also enable extrapolation of the results and experiences gained from one area to similar areas where no conservation measures have been carried out and thus ensure that the available knowledge is used without unnecessary duplication.

Land evaluation is the process of collating and interpreting basic inventories of soil, vegetation, climate and other aspects of land in order to identify and make a comparison of promising land-use alternatives in terms applicable to the objectives of the evaluation. It is the purpose of this paper to outline the role of soil surveys and land evaluation in assessing erosion hazard and also to give a qualitative assessment of susceptibility to erosion of some of the major soils of Kenya.

RESOURCE INVENTORY AND ASSESSMENT

Since 1972 the Kenya Soil Survey embarked upon a programme of systematic inventory of the soil and land resources of the country, by mapping them per quarter-degree topographical sheet at reconnaissance level; reconnaissance soil surveys (scale 1:100,000 for the high-and medium-potential areas; 1:250,000 for the low potential areas).

These surveys are carried out to serve multi-purpose land use planning.

In addition to reconnaissance soil surveys other soil surveys are being conducted at various levels of details. These levels involve site evaluations, exploratory, semi-detailed and detailed mapping. The level of mapping depends on the purpose of investigation but all soil maps are interpreted to provide the information that is also relevant to the need of the land user. Thus the exploratory soil map of the country at scale 1:1,000,000 can be utilized in assessing the degradation hazard of the major soils of the country at the national level. The reconnaissance soil surveys (scale 1:100,000 or 1:250,000) can be used to assess soil degradation hazards at the regional level or per major catchment areas. Where no information exists at reconnaissance level, site evaluations can be carried out. These are short period investigations which depend largely on aerial photo interpretations and are primarily aimed at a preliminary assessment of the situation for a project formulation.

For all the areas covered by the reconnaissance soil surveys a land evaluation is carried out. This involves the assessment of essential land characteristics to provide ratings of relative suitability of the land for physically possible and socially and economically promising forms of land use with minimum land degradation hazard. For each survey area, background studies are carried out to define the relevant land use alternatives. The rating of the suitability of the different tracts of land in a survey area for any particular land utilization type is done largely in a relative, qualitative way.

The comprehensive aspect of the land evaluation on the basis of reconnaissance soil survey implies that not only the soils themselves are studied but also topography (including gullying), the climate, the vegetative cover, the present-day land use and the erosion susceptibility. All land suitability assessments carried out presuppose stable and sustained agricultural use ie. land degradation through soil erosion, including

FIG. 1 Location of reconnaissance soil surveys

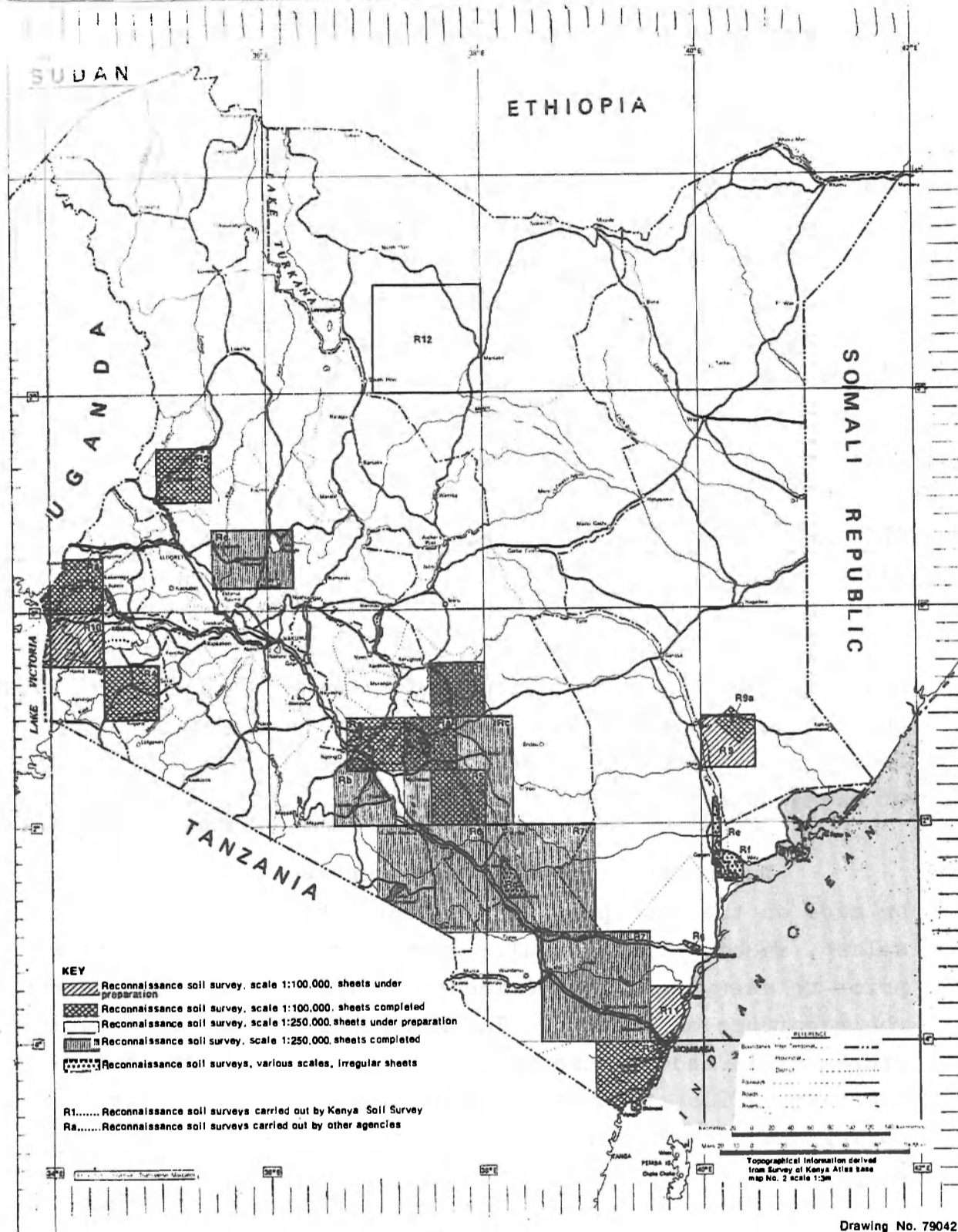

soil fertility loss, is precluded if a tract of land is grouped with any of the classes of suitability. Erosion susceptibility receives particular attention during the surveys. A soil erosion hazard map is normally included in the soils report. The estimation of the soil erosion hazard per mapping unit takes into account: slope (percent and length), climate (especially rainfall characteristics) and susceptibility to sealing/capping of bare soil surface. The latter is based on an empirical combination of data on topsoil structure, structure stability, grain size distribution (especially silt/clay ratio), bulk densities, infiltration measurements and visual observations. Figure 1 gives the location of areas where reconnaissance soil surveys with a comprehensive land evaluation have been carried out.

GENERAL OBSERVATIONS ON SUSCEPTIBILITY TO SOIL EROSION OF SOME MAJOR SOILS OF KENYA

All sloping lands are exposed to erosion if not properly managed and protected. Depending on the soil type, particularly on soil texture and structure, the grade of erosion will differ from place to place on different slopes and under different levels of management.

During the course of soil surveys some observations can be made on the susceptibility of soils to erosion by observing splash, sheet, rill and gully erosion and also wind erosion prior to carrying out experiments or measurements to determine the magnitude of erosion. In this paper a brief qualitative statement is made on the susceptibility to erosion of some of the major soils of Kenya. The observations noted have been made during the course of the exploratory and reconnaissance soil mapping.

Luvisols and Acrisols are soils with an ABC sequence of horizons, of which the A-horizon is relatively low in organic matter and/or is acid. The B-horizon is argillic and is

Luvisols and Acrisols are soils with an ABC sequence of horizons, of which the A-horizon is relatively low in organic matter and/or is acid. The B-horizon is argillic and is

characterised by illuviation of silicate clay minerals. The illuviation usually shows a distinct increase of texture over relatively short distance. The structure of the B-horizon is usually angular blocky. Luvisols have a base saturation determined by NH_4OAC at pH 7.0 of more than 50% whereas Acrisols have a base saturation of less than 50%.

The subsoil of these soils often has low porosity and has relatively high bulk densities. This results in relatively low water storage capacity. These soils have a poor structural stability of the topsoil resulting in a tendency to form a strong seal on the surface. This again leads to low infiltration rates and hence a lot of run-off. As a result of this, these soils are easily eroded and the erosion can be severe even on gentle slopes. Luvisols and Acrisols are widespread in Kenya, the bulk of them being found in the semi-arid areas.

Nitosols

These are very deep, often dark red, dusky red or dark reddish brown clay soils. They usually have a moderate to strong subangular blocky topsoil which is underlain by a moderate angular blocky subsoil. The soils are friable or very friable and are porous throughout.

They are developed on base-rich rocks and occur on undulating to rolling uplands in moister climates than the Luvisols and Acrisols. They have a favourable moisture storage capacity and aeration conditions. They show a marked structure stability which enables them to be cultivated even on moderately steep gradients with minimum degradation hazard.

Ferralsols and Intergrades

Ferralsols are strongly weathered and strongly leached soils with indistinct soil horizon differentiation. They have a texture of sandy loam or finer. They are friable, highly porous and permeable. The structure is weakly coherent massive to

subangular blocky and is characteristically stable. Some of the Ferralsols have high infiltration rates and hence are relatively resistant to erosion. However, associated with Ferralsols are intergrades between Ferralsols and Luvisols or intergrades between Ferralsols and Acrisols. These intergrades, like the Acrisols and Luvisols, have a tendency to form a strong seal on the surface. This leads to low infiltration rates and hence run-off. These intergrading soils are therefore easily eroded.

The Ferralsols and intergrades are often found occurring on old geomorphic surfaces in Machakos, Kitui, Kajiado, Kwale, Embu, Trans Nzoia, Busia, Siaya and Kisii Districts.

Vertisols

These are mainly dark, cracking clay soils lacking distinct horizons in their profile. They are fine in texture and the clay minerals are of the montmorillonite type. During the dry season they shrink markedly and large cracks develop whilst during the wet season the soil swells. The infiltration rates of the dry soil is very high because of the many cracks. The permeability drops to very low values once the soil is saturated. Under this condition the soil is very susceptible to erosion.

Vertisols are widespread in Kenya. They are found in the Kano Plains, Athi Plains, Mwea Plain, Laikipia District, Yatta, Masinga and Bura East.

Solonetz

These are soils that contain little soluble salts but much exchangeable sodium on the exchange complex. A high level of exchangeable sodium causes the clay to disperse. The dispersed clay subsequently moves from the A to the B horizon, and forms a natric horizon. The texture of the A-horizon is usually lighter than that of the B-horizon. It has been noted

in the Marsabit-Kulala area that where the vegetation cover has been removed on these soils due to over-grazing, the soils have been subjected to very severe soil erosion both by wind and water action. This has left exposed the natric B horizon which can barely support plant growth due to its high exchangeable sodium content and associated poor physical properties. Solonetz are found in association with Solonchaks mainly in the semi-arid and arid parts of Kenya.

Arenosols

These are coarse textured soils containing less than 15% clay. They commonly occur on quartz-rich crystalline or sedimentary rocks or unconsolidated sediments derived from them. They have a low moisture storage capacity per unit volume. Some Arenosols have a tendency for the surface horizon to harden when the soil dries out at the end of the rainy season. This may decrease the porosity of the topsoil and hence result in run-off and erosion. It has also been noted that Arenosols are susceptible to gully erosion.

Arenosols are common in the coastal area and North Eastern Kenya.

Lithosols

These are shallow soils which have a continuous coherent and hard rock within 10 cm of the surface. Most of the Lithosols usually occur on slopes with excessive and often erosive run-off. They are therefore very susceptible to erosion. They are often found in the hilly and mountainous areas in association with Cambisols and Regosols.

Andosols

These are soils that are formed from recent volcanic material. They have a thick, loose, granular dark grey to black A horizon over a yellowish brown or brownish C horizon. They may be coarse or fine textured but have usually a high silt

content. Although Andosols have good physical characteristics and a high water storage capacity erosion may be a serious problem as they consist of rather loose material and often occur on steep slopes of the volcanic areas.

Andosols are found in Nyandarua District, Longonot and Naivasha areas, Chyulu Range, Kinale Forest and Mau Escarpment areas.

Planosols

These are imperfectly drained soils with a pronounced and abrupt transition between a relatively light textured topsoil and a heavy textured, compact and hard B-horizon. They are found on flat or slightly depressional old land surfaces and are subject to very little actual erosion. However, their susceptibility to erosion is very high in areas where the vegetation cover has been reduced by over-grazing.

They are extensively found in the Kinangop plateau and Sotik plateau. They are also found in association with other soils in Laikipia District, Kajiado District and Kwale District.

REFERENCES

For the references the reader is referred to the 'Kenya Soil Survey List of Publications, February 1981'.

A PRELIMINARY REPORT ON AN EVALUATION
AND DETAILED MAPPING OF THE EROSION
SUSCEPTIBILITY AT KALOLENI, KILIFI
DISTRICT

By

C.K.K. Gachene

and

R.G. Barber
Kenya Soil Survey and Department
of Soil Science, University of
Nairobi

INTRODUCTION

It is interesting to note that the soil forming factors - climate, parent material, topography, vegetation, time and man - are very similar to those factors determining soil erosion. This relationship suggests that a soil survey forms a reasonable basis for an erosion survey. Although abundant soil surveys have been carried out in many parts of the world, relatively few attempts have been made at mapping soil erosion susceptibility or erosion hazard especially at a detailed scale. Many research workers are now realizing the need for simultaneously combining soil survey work with erosion susceptibility or erosion hazard mapping since similar data are required for both exercises.

Definitions

Soil erosion hazard is a measure of the degree of soil erosion that is likely to occur when soil erosion has already begun (Bergsma, 1973). Thus when erosion is already in evidence, the erosion hazard reflects the combined effects of all those factors influencing erosion, namely climate, soil type, topography, land use and management practices.

Soil erosion susceptibility is that part of the erosion hazard, which depends only on relatively permanent environmental factors, of climate, topography and soil properties (Bergsma, 1973; Morgan, 1978). Thus the relatively unstable factors such as present natural vegetation, land use and management practises are excluded, and so the erosion susceptibility will not, in general, change with time, in contrast to the erosion hazard which can be greatly affected by changes in land use and conservation practices.

Erosion susceptibility data and maps are of greatest value in delineating areas which differ in their degree of erosion susceptibility, and therefore help to identify those areas which are most in need of erosion control measures. Such data can also serve as a starting point to evaluate the expected risk of erosion under alternative land utilization types, and what practices may be required to provide for a sustained use of the land under these alternative uses. Consequently soil erosion susceptibility is an important, factor in land evaluation studies.

Various research workers have mapped soil erosion susceptibility or hazard in the field using qualitative methods in which slope length, gradient, soil erodibility, climatic erosivity, crop and management practices are rated by a scoring system (Morgan, 1978; Arnoldus, 1974). In such systems, each of these factors is rated on a scale where the lowest number, normally taken as 1, is associated with a low risk of erosion and the highest number with a high risk. The factor scores are multiplied to give a product score which is compared with a chosen classification system to indentify areas of low, moderate and high erosion risk. The scores are mapped, and areas of similar risk are delineated to give a soil erosion susceptibility/hazard map. In Kenya, the Kenya Soil Survey (KSS) has developed a method of evaluating soil erosion 'hazard' at a reconnaissance level (Braun and van de Weg, 1977; Braun and Muchena, 1978, Mbuvi and van de Weg, 1975; Gelens et al, 1976, and Michieka et al, 1978). In the KSS method, an evaluation of the soil erosion 'hazard' is

mapped on the basis of slope length, climate, slope class and soil erodibility. These factors are rated and the ratings are added up. The final rating is classified to give a measure of the soil erosion 'hazard'. However, according to the definitions given by Bergsma (1973), the KSS is actually mapping soil erosion susceptibility and not soil erosion hazard. Bergsma (date unknown) carried out a reconnaissance survey of erosion hazard near Merida, Spain. He made a qualitative evaluation of slope steepness. Slope length, relative position, soil erodibility, vegetative cover and land management. Where conservation practices were being practiced, he reduced the hazard by one class. Elwell(1981) used the percentage seasonal rainfall energy intercepted by the vegetative canopy, rainfall energy, soil erodibility and a topographic ratio to estimate the soil erosion hazard in Zimbabwe. Morgan (1978) conducted reconnaissance, semi-detailed and detailed erosion surveys in Malaysia, Peninsular. At a reconnaissance level, Morgan considered only climate. He did not introduce any category of low erosion risk, for he argued that at least a moderate risk of erosion exists in any humid tropical environment. Arnoldus (1974) has argued on similar lines. At a semi-detailed level, Morgan took into account the influence of soils, drainage density, slopes and landuse. At a detailed level, the catchment was observed regularly for a period of 8 months which enabled Morgan to monitor the frequency of overland flow and hence to distinguish between past and present erosion features. Morgan criticises additive rating systems where each factor is given equal weight and each factor is treated independently, whereas as many authors have shown, there is interaction between the factors. Consequently it would be more appropriate to combine them by multiplication.

The aim of this paper is to present the provisional findings of an M.Sc. project undertaken by the senior author to evaluate and map, at a detailed scale, the erosion susceptibility of a small area of 185 ha at Kaloleni, Kilifi District, Kenya. The approach used was a quantitative parametric method based on the universal soil loss equation (USLE)

(Wischmeier and Smith, 1965), and similar, in some respects, to the method proposed by FAO (1979) for assessing the risk of soil degradation by water. This approach is rather tedious and time consuming but is assumed to give the most accurate assessment of the comparative erosion susceptibility of land. The second part of the study attempted to evaluate how well some qualitative rating methods, which have the advantage of being simpler and quicker to carry out, compare with the erosion susceptibility map obtained, by the quantitative parametric approach, particularly with respect to the modal slopes within the landscape. In this paper, only one qualitative rating method will be considered. It is also hoped that this detailed study may prove to be of value in developing improved procedures for erosion susceptibility mapping at smaller scales.

METHODOLOGY

The area in which the survey was carried out occupied 185 ha at Kaloleni, Kilifi District. The underlying geology was mainly Mariakani sandstones of Triassic age and the slopes were predominantly uniform or convex in shape.

a) Evaluation and Mapping of the Erosion Susceptibility by the Quantitative Parametric Approach

Erosivity Evaluation

The erosivity R factors in ft tons in/acre per year were calculated from the following regression on kinetic energy (KE), where KE is the kinetic energy of rain falling at intensities greater than 25 mm/h for 15 minute periods (Moore, 1979)

$$R = 0.029 KE - 26.0 \qquad r = 0.95$$

The KE values for coastal areas, within which Kaloleni occurs, were obtained from the following regression on mean annual rainfall (x) in mm/yr (Moore, 1979)

$$R = 0.029 KE - 26.0 \quad r = 0.95$$

The KE values for coastal areas, within which Kaloleni occurs, were obtained from the following regression on mean annual rainfall (x) in mm/yr (Moore, 1979)

$$KE = 22.82 x - 15795 \quad r = 0.84$$

This index of climatic erosivity is different to that used by KSS for reconnaissance scales surveys where the erosivity is based on the ratio of rainfall to potential evapotranspiration values (Braun and van de Weg, 1977).

Erodibility Evaluation

A regression equation developed by Gachene (1981) for predicting the erodibility of well drained, non-swelling soils has been used. This regression, between dispersion ratio, clay, organic matter, bulk density and soil loss, appeared to be superior to Wischmeier's nomograph (Wischmeier et al (1971) and to the KSS method (Braun and van de Weg, 1977). This part of the study is still being written up (Gachene 1981) and is not considered: in this paper. The estimated erodibility factors however, do not give realistic values for soil erodibility factor in the Universal Soil loss Equation because they are based on soil losses from single storms (simulated) on small disturbed samples. Nevertheless the relative values between soils should be valid.

Topography Evaluation

This is based on measurements of slope gradients and slope length (L) where L is defined as the distance between the point of origin of overland flow and the point where the gradient is shallow enough for deposition to begin, or where runoff enters a drainage channel. The LS factor was evaluated for each slope segment, delineated by a change in soil type, a break in slope, or a change in slope category, by the method of Foster and Wischmeier (1974). For slope segment 'j' in a

sequence of segments from crest line to drainage line or the lowest point of a slope length (as defined above), the LS factor is given by the following relationship;

$$LS_j = S_j \frac{\lambda_j^{m+1} - \lambda_{j-1}^{m+1}}{22.1^m (\lambda_j - \lambda_{j-1})}$$

Where S_j is the slope factor for segment 'j' given by

$$S = \frac{(0.034S^2 + 0.30S + 0.45)}{6.613}$$

Where S = % slope

λ_j = distance from crest line to bottom of segment 'j' (m)

λ_{j-1} = distance from crest line to bottom of segment 'j-1'
(m)

m = exponent, assumed = 0.5

In this evaluation procedure, soil loss increases logarithmically with both increasing slope gradient and slope length.

Mapping Procedure

A detailed soil map at a scale of 1:10,000 was produced by an interpretation of 1:6,250 aerial photographs of the area, combined with a grid system ground survey where auger samples were described to 120 cm depth on a grid spacing of 200 x 100 m. The soil observation density was one per hectare. The distribution of the soils is shown in Fig. 1. Soil profile pits representative of each of the main soil mapping units were described and analysed to provide the data for evaluating the erodibility factors. Soil mapping took 2½ man months to complete.

Simultaneously with the mapping of the soils, slope lengths, using a 100 m tape, and slope gradients, using an Abney level, were measured. Slope lengths and slope gradients were measured from crest lines down-slope at right angles to the contours for each slope segment to the point where the

gradient became sufficiently shallow for sediments deposition to occur, or to a drainage channel. Slope segments were delineated by a change in soil type, a break in slope, or a change in the slope category. Five slope categories were selected of $0-1^{\circ}$, $1.1-3^{\circ}$, $3.1-5^{\circ}$, $5.1-8^{\circ}$ and more than 8° . The slope gradient map is shown in Fig. 2.

Erosion Susceptibility Evaluation

The slope gradient map was combined with the soil map to produce a slope gradient - soil map. The LS factors were then evaluated for each soil/slope segment unit in a series of 'traverses', selected to cover the whole of the area, from ridge tops to valley bottoms at right angles to the contour lines. The LS, K and R factors were multiplied together to obtain the erosion susceptibility values. These values were then assigned to five erosion susceptibility classes as shown in Fig. 3.

b) Evaluation and Mapping of the Erosion Susceptibility by the Qualitative Rating Method

In this method, the erodibility and slope length parameters are all rated on a 1 to 5 basis, with 1 representing a very low risk and 5 a very high risk of erosion. The slope gradient parameter was given a higher rating of 1 to 9 because of the greater influence slope gradient is believed to exert on soil erosion (Wischmeier and Smith, 1978). This is also in agreement with Braun's (Braun and van de Weg, 1977) method of rating the slope gradient.

Erosivity Evaluation

The erosivity R factor was calculated by the regression given by Moore (1979) and was rated at 3 for the Kaloleni area according to the following rating system.

| <u>Sub-rating</u> | <u>Erosivity (English units)</u> |
|-------------------|----------------------------------|
| 1 | ≤ 100 |
| 2 | 101- 200 |
| 3 | 201- 300 |
| 4 | 301- 400 |
| 5 | > 400 |

Erodibility evaluation

The erodibility K factor values obtained by Gachene (1981) were rated from 1 to 5.

| <u>Sub-rating</u> | <u>Erodibility (English units)</u> |
|-------------------|------------------------------------|
| 1 | ≤ 0.12 |
| 2 | 0.13-0.24 |
| 3 | 0.25-0.36 |
| 4 | 0.37-0.48 |
| 5 | > 0.48 |

Topography Evaluation

The slope gradients used in the evaluation are the modal slope gradients for the whole slope length. The slopes were not divided into slope segments. Rating of the slope gradients is as follows:

| <u>Sub-rating</u> | <u>Modal slope gradient (%)</u> |
|-------------------|---------------------------------|
| 1 | 0-5 |
| 3 | 5-8 |
| 5 | 8-16 |
| 7 | 16-30 |
| 9 | >30 |

The slope length parameters are rated:-

| <u>Sub-rating</u> | <u>Slope length (m)</u> |
|-------------------|-------------------------|
| 1 | ≤ 50 |
| 2 | 51-100 |
| 3 | 101-200 |
| 4 | 201-300 |
| 5 | 300 |

Erosion Susceptibility Evaluation

The sub-ratings for erosivity, erodibility, slope gradient and slope length were multiplied together to give a product score which is then rated from 1 to 5 as follows:

| <u>Rating</u> | <u>Erosion susceptibility</u> | <u>Sub-ratings product</u> |
|---------------|-------------------------------|----------------------------|
| 1 | very low | 0-50 |
| 2 | low | 50-100 |
| 3 | moderate | 100-150 |
| 4 | high | 150-200 |
| 5 | very high | > 200 |

The erosion susceptibility map by this qualitative rating method is given in Fig. 4.

DISCUSSION

Although surface soil properties such as texture, depth of A, horizon, stoniness etc were examined so that the soils could be mapped at the type or phase level, the soils appeared to be remarkably uniform in their top soil as well as subsoil characteristics. Therefore the soils could have been classified at a low category level compatible with the detailed scale of mapping. However due to the lack of lower level categories in the FAO system, the soils were only classified here at the subgroup level.

It has been assumed that the quantitative method gives the best index of erosion susceptibility since it is a detailed slope segment analysis based on the product of R, K and LS factors. We believe the R factor used is the best index of erosivity presently available in Kenya. The K factors, though unreliable in absolute terms are probably reasonably valid in relative terms. The LS factors are presumably valid, as there is no reason to believe the LS relationship established in one country, such as USA, should be different in another country (Foster et al 1979), since the LS factor merely reflects the influence of slope and

relief on the detaching and transporting capacity of overland flow which is basically determined by energy-force relationships.

When comparing the soil and slope maps with the quantitative erosion susceptibility map, it can be seen that most of the least susceptible areas are associated with the luvic arenosols and the plinthic Luvisols in the most gently sloping areas, generally less than 3° . On the other hand most of the areas with a very high erosion susceptibility are associated with chromic luvisols and chromic luvisols with pockets of lithosols which occur on slopes ranging from 3° to 11° . In some areas, where the chromic luvisols were associated with slopes of $3-5^{\circ}$, the erosion susceptibility was moderate to high. Thus slope gradient appears to have an important influence on the erosion susceptibility as would be expected.

The quantitative erosion susceptibility map also reflects the importance of slope position as shown in Fig. 3. i.e. there is a trend of increasing erosion susceptibility from crest line to drainage channel. The vast majority of the slopes in this area, with the exception of the concave slopes associated with the cambic arenosols and the luvic arenosols in the north east are uniform, or more commonly convex in shape. Thus it is the slope segments occupying the lowest position in convex sloping areas and hence with the steepest slopes, often $5-11^{\circ}$, which were generally most susceptible to erosion. The other factor giving high erosion susceptibility values was the long slope length often in excess of 300 m, which encouraged the accumulation of increasing volumes of runoff in a downslope direction.

Field observation supported in general the erosion susceptibility rating map produced by this method. Thus on the steep lower convex slope positions, there were frequent signs of tree root exposures and gully erosion. Stout (1965), Morgan (1978) and Bergsma (1973) have also observed that on uniform or convex slopes, more soil is lost from the lower lying slope segments than from upper-lying segments.

Although this method is presumed to have given a reasonably detailed and accurate indication of the relative erosion susceptibility of the area, the method is tedious and time consuming. It does however pin point the critical or most erosion sensitive areas namely the valley sides with steep slopes at the foot of long convex or uniform slopes. Thus great attention should be paid to these areas when advising farmers on the need for conservation measures. Alternatively, or preferably, these areas should be left under pasture, bush or woodland.

The soil erosion susceptibility map produced by the rating method cannot be expected to give such a detailed or accurate assessment of erosion susceptibility since total slope lengths were considered instead of subdividing the slopes into segments. Thus the best that can be hoped for is a reasonably good correlation with the quantitative method for the modal slopes within the catenary sequence.

The erosion susceptibility map (Fig. 4), based on the qualitative rating method shows that, susceptibility to erosion generally increases from crest line downslope and in some places then decreases before the drainage channel is reached, even though slope gradient is increasing with slope length. This suggests that either deposition is occurring on the valley side slopes (where signs of gully erosion were observed!) or that the lower slope segments were not influenced by overland flow from the upper segments. The distribution of erosion susceptibility ratings especially in the south west part of the area is rather contradictory to field observations since the chromic Luvisols with pockets of Lithosols showed signs of gully erosion where these signs were not visible on the chromic Luvisols occurring upslope. Nevertheless, in many areas the classification of the modal slopes by the qualitative rating method coincided fairly well with the quantitative parametric method. This is mainly in the north eastern part of the map having slopes 5 to 8° and along the crest lines. Clearly however, there is room for improvement in this method.

The main deficiencies in this approach appear to be the inability of this method to indicate the existence of, albeit relatively short, but highly erosion susceptible lower slope sites. Perhaps this could be overcome to some extent by including slope shape and slope position as additional parameters within the rating method. Thus landscapes with pronounced convex or concave slopes would be expected, other factors being constant, to be characterized by relatively higher and lower erosion susceptible lower slope positions respectively, compared to the upper slopes. Moreover these differences would be further accentuated in situations with very long slopes.

It is hoped that the qualitative rating method reported here can be further improved but even if it can be developed to give a reasonably good evaluation of the erosion susceptibility of this small area, there is no guarantee that it will prove to be adequate in other areas. Nevertheless, it is felt that some of the evaluation procedures and concepts introduced here will help in developing better, more generally applicable methods of evaluating and mapping erosion susceptibility at both detailed and smaller mapping scales.

Acknowledgements

All the help and facilities offered to the authors by Kenya Soil Survey, Netherlands Training Project in Pedology and the Department of Soil Science University of Nairobi are gratefully acknowledged.

REFERENCES

- Arnoldus, H.M.J., 1974: Soil Erosion: A review of processes, assessment technique. Agric. University, Wageningen - Netherlands.
- Bergsma, E., 1973: Erosion Factors. Part II. ITC 9/71. Revision 8/77.
- Bergsma, E. date unknown. Reconnaissance survey of erosion hazard near Merida, Spain.
- Braun, H.M.H. and Muchena, F.N. 1978. The Kenya Soil Survey and Soil Conservation. Paper presented at a soil and water conservation workshop in Kenya held at Faculty of Agriculture 21-23rd September 1977.
- _____, and van de Weg, R.F. 1977. Proposals for rating of land qualities. Internal Comm. No. 7. Ministry of Agric., Kenya Soil Survey.
- Elwell, H.A. 1981. A soil loss estimation technique for Southern Africa, pp. 281-292 in Morgan. R.P.C. Soil Conservation: Problems and Prospects. Ed.
- FAO, 1979. A provisional methodology for soil degradation assessment FAO, Rome.
- Foster, G.R. and Wischmeier, W.H., 1974: Evaluating irregular slopes for soil Loss Prediction. TRANSACTIONS ASAE pp 305 - 311.
- _____, Moldenhauer, W.C. and Wischmeier, W.H., 1979. Transferability of U.S. Technology for Prediction and Control of Erosion in the Tropics.
- Gachene, C.K.K., 1981. Measurement of the relative erodibility of some Kenyan soils using a rainfall simulator. M.Sc. thesis Part I - in preparation.
- Gelens H.F., Kinyanjui, H.C.K. and van de Weg, R.F., 1976. Soils of the Kapenguria Area. Kenya Soil Survey, R2.
- Mbuvi J.P. and van de Weg, R.F. 1975: Soils of the Kindaruma Area. Kenya Soil Survey, R1.
- Michieka, D.O; Vleeshouwer, J.J. and van der Pouw, B.J.A. 1978. Soils of the Kwale area. KSS, R3.
- Moore, T.R., 1979. Rainfall erosivity in East Africa. Geogr. Ann. 61A(3-4): pp. 147-156.
- Morgan, R.P.C. 1978: Soil erosion. Longman London and New York.
- Stout, B.A. 1965. Soil Erosion by Water. Some measures of its control on cultivated lands. F.A.O. Rome.

Wischmeier, W.H, Johnson, C.B. and Cross, B.V., 1971. 'A soil erodibility nomograph for farmland and construction sites.' J. of Soil and Water Conservation, 26 (5) 189-193.

_____, and Smith, D.O. 1965. 'Predicting rainfall erosion losses from cropland east of the Rocky Mountains.' Agric. Handbook No. 282. US Govt. Printing Office.

_____, and Smith, D.D., 1978. 'Predicting rainfall erosion losses. A guide to Conservation Planning'. USDA, Agric. Handbook 537.

FIG. 1 Preliminary Generalised Soil Map of Kizurini - Kaloleni.

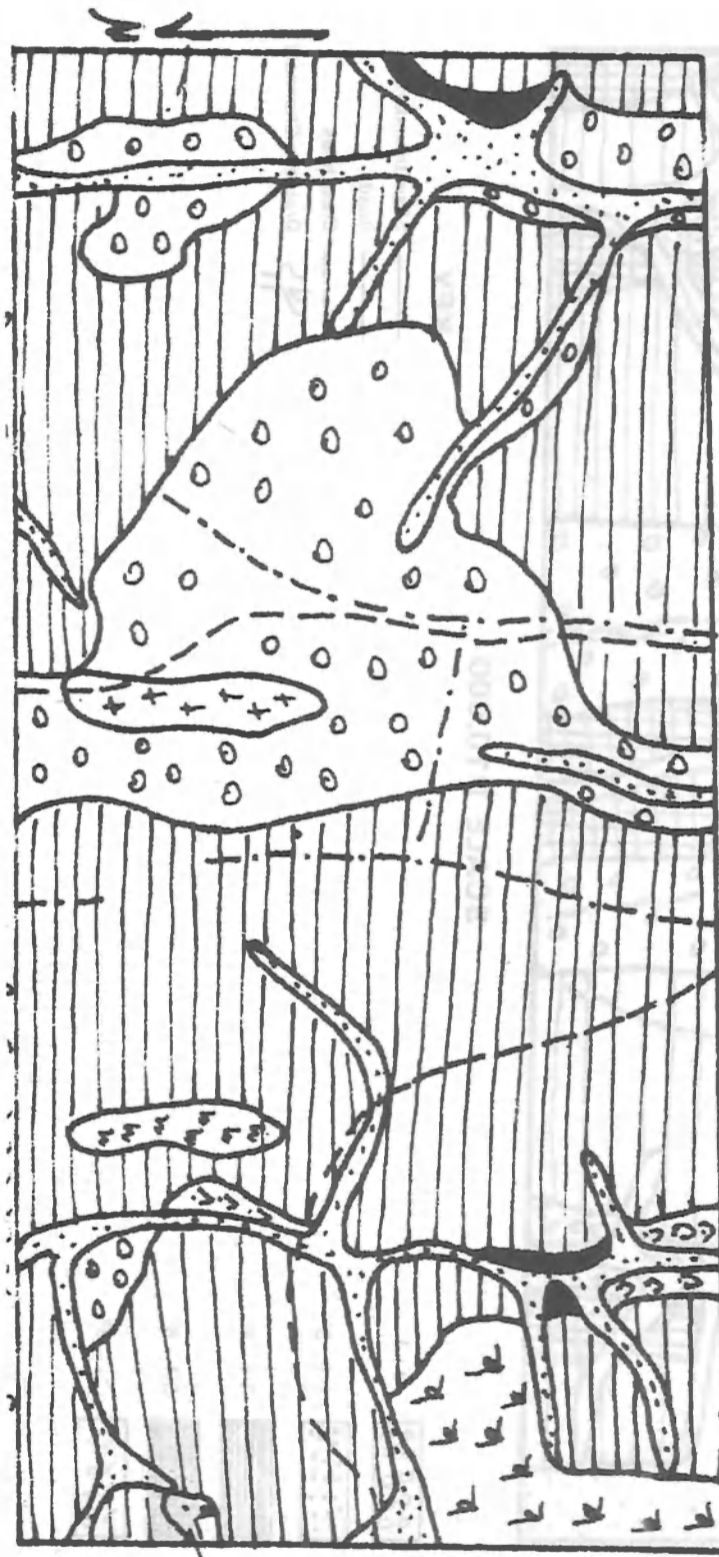

KEY
 Soil boundaries
 Roads
 Crest lines

SCALE 1:10,000

Soil legend

- Soils of varying drainage, depth, colour.
(Consistence and texture, showing stratification (eutric dystic fluvisols))
- Well drained shallow, strong brown to yellow red friable to firms, sandy clay, loam topsoil, stony and rocky (lithosols).
- Well drained moderately deep, dark br. to yellowish br., friable sandy loams to loamy sand (luvic Arenosols)
- Somewhat excessively drained, very deep, yel. br. to br. yellow, friable, loamy sand underlying 25 - 35 cm. v.d. greyish brown, sand loam to soil (luvic Arenosols)
- Well drained, very deep, strong brown to yel. red, friable to firm, sandy clay loam to sandy clay (luvic arenosols).
- Like chromic luvisols but with pockets of lithosols.
- Moderately drained moderately deep to deep yel. brown, firm clay underlying 20 - 28 cm dark greyish brown, sandy clay to clay topsoil (plinthic luvisols)
- Complex of: Plinthic luvisols and greyish luvisols.

FIG. 2 SLOPE GRADIENT MAP

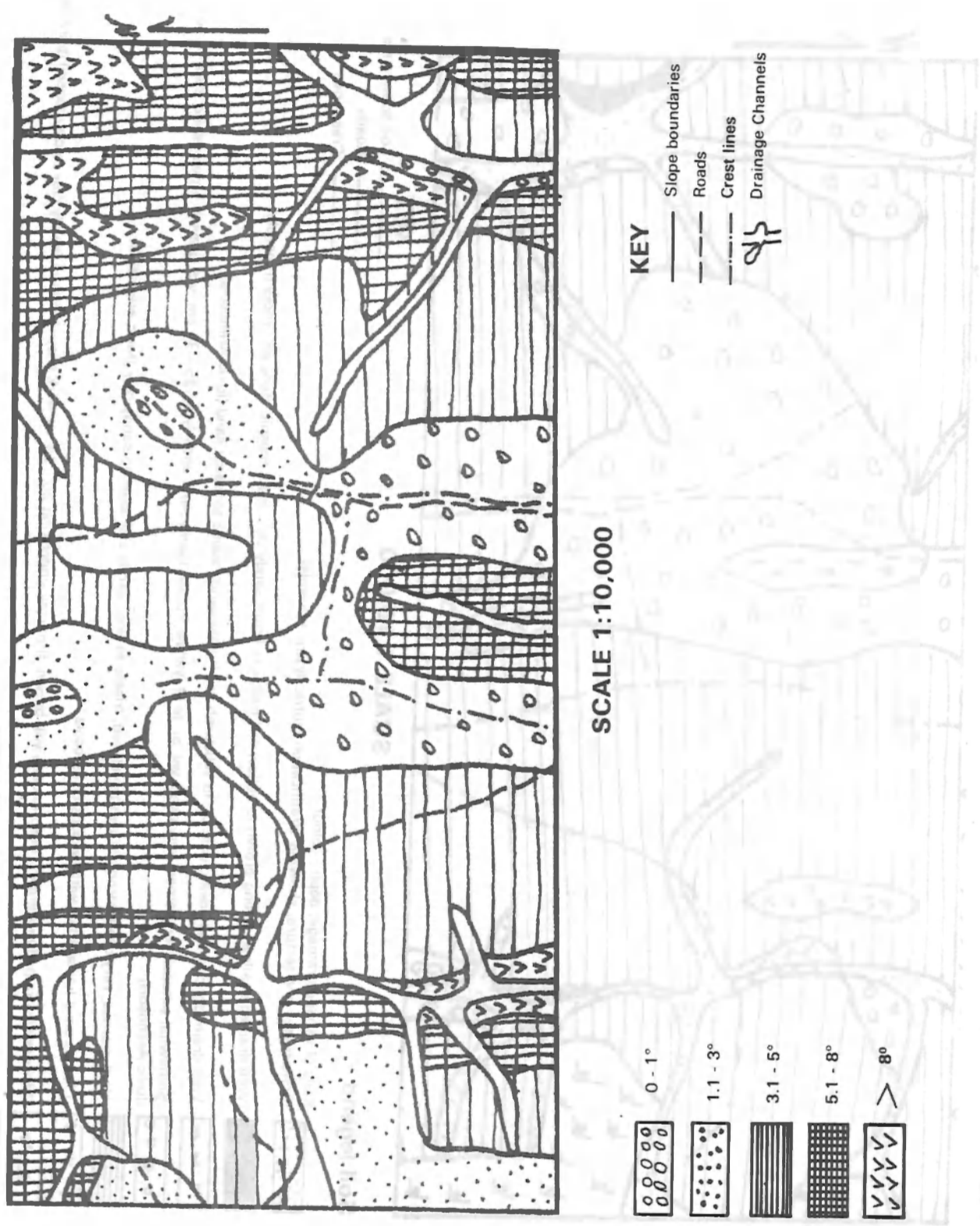

FIG. 1. Картини на Генералниот Социјален Мапа од Китојани - Китојани

FIG. 3
Soil Erosion susceptibility map as evaluated by the quantitative method.

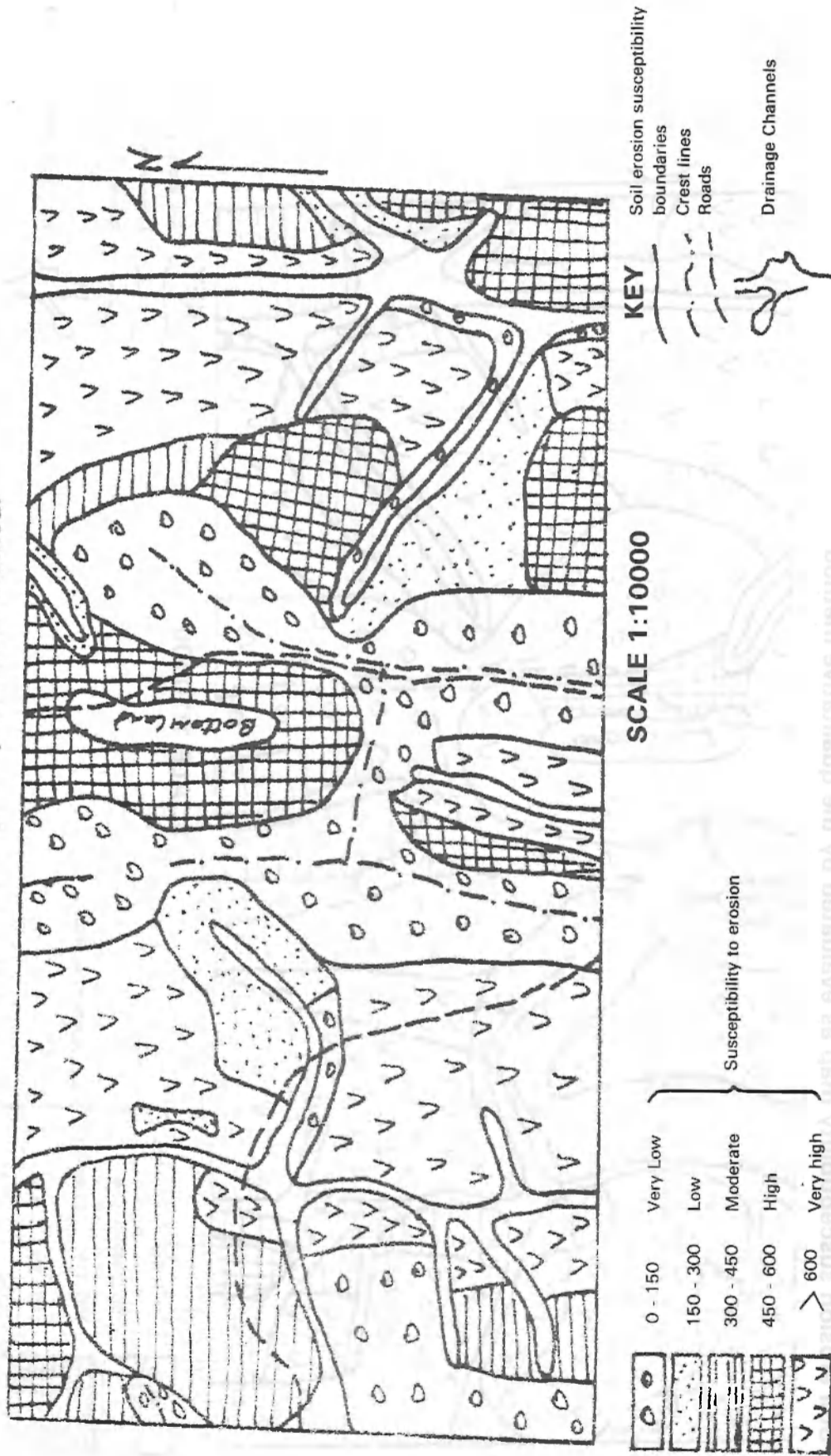
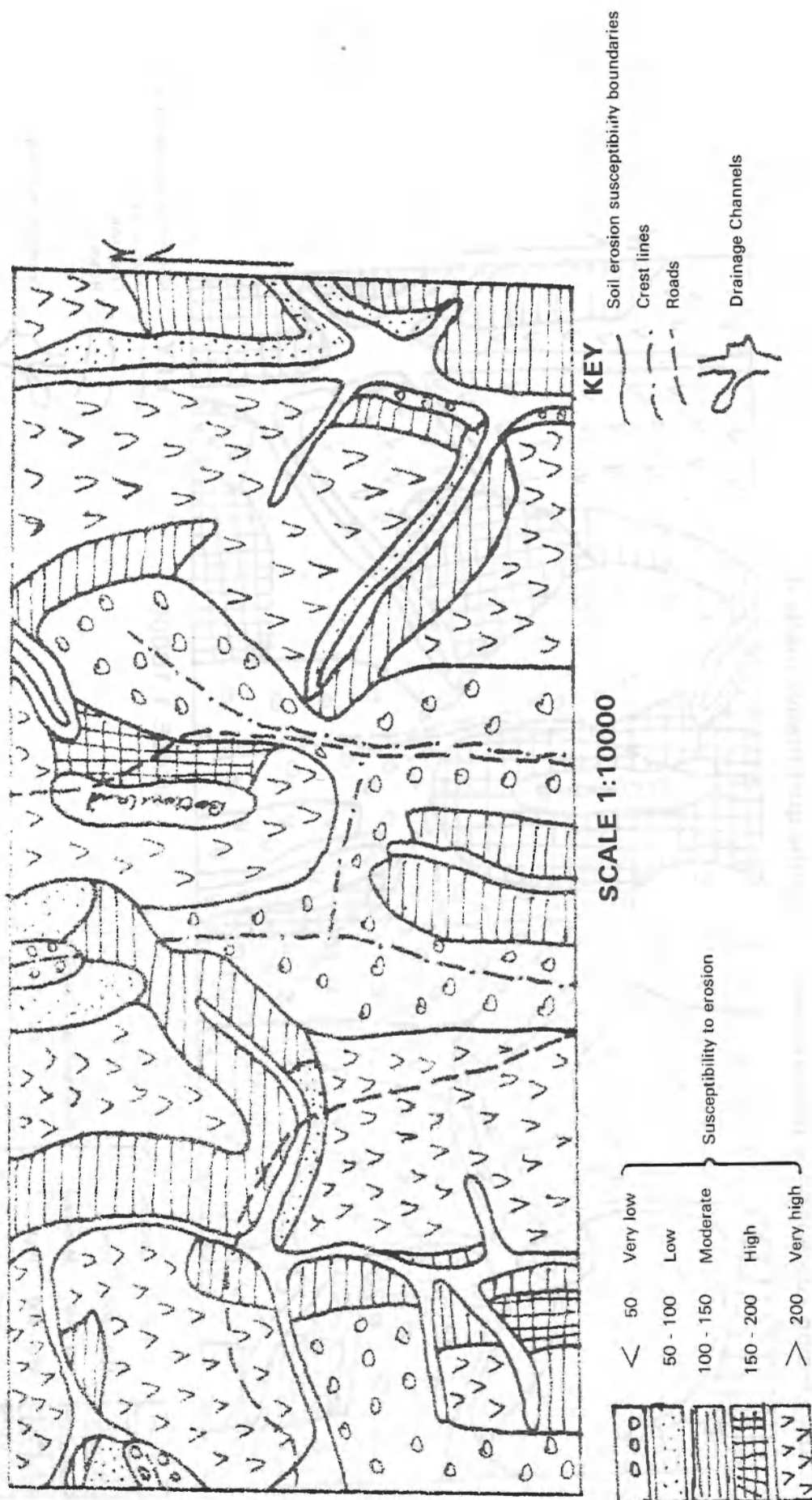

FIG. 3

FIG. 4
Soil erosion susceptibility map as evaluated by the qualitative method



A RECONNAISSANCE SURVEY OF EROSION PROCESSES
IN MACHAKOS DISTRICT, KENYA

By

Leslie M. Reid
University of Washington
Seattle
USA/
EcoSystems
Ltd.
Nairobi
Kenya

Severe soil erosion was recognized as a problem in Machakos District in the 1920's, and since then a variety of measures have been implemented to try to control the erosion. With a history of 60 years of soil conservation measures in effect and a continuing erosion problem, it would be useful to: 1) evaluate the effectiveness of measures already implemented; 2) identify areas needing further conservation work; 3) identify those sediment sources which should be controlled; and 4) determine which soil conservation measures should be implemented in a given situation.

In order to address any one of these problems, it is necessary to have an understanding of the sediment sources. Erosion rates must be defined in terms of both the types of sources contributing sediment and the spatial distribution of those sources. In addition, if the factors controlling erosion rates are known and if erosion rates can be calculated for various combinations and values of the controlling factors, then erosion rates at specific sites and for proposed conservation measures can be estimated given measurements of the controlling factors. This procedure requires the construction of a partial sediment budget for the area of interest. To do so,

1. The significant sources of sediment in the area must be identified.
2. The spatial distribution of each erosion process must be determined.
3. The sediment production rate from each source must be estimated as a function of the rate-controlling variables such as local slope, soil type, and rainfall intensity. Measurements should thus be made over a long enough time period that a representative

distribution of weather conditions may be sampled, and over a wide enough area that a variety of physical parameters may be controlled for.

A complete sediment budget would account for the movement of sediment both before and after its initial dislodgement from the soil surface, providing quantitative measures of soil formation, weathering, and creep rates, and describing rates of sediment transport through the catchment (Dietrich et al., in press).

During 1981 a partial sediment budget was constructed for Machakos District by request of the Machakos Integrated Development Programme and with funding from the European Development Fund. Machakos District is an area of 14,000 km² located directly east of Nairobi (see Figure 1), which contains a variety of topographic, geologic, and climatic conditions. The central part of the district is hilly. Here the bedrock is pre-Cambrian schist and gneiss of the Basement Complex, and the soils derived from it are sandy and often shallow. To the west are Tertiary volcanic plains with vertisolic soils, and further south the Chyulu Hills, a series of Quaternary cinder cones and lava flows. Average annual precipitation correlates closely with altitude, ranging from about 400 mm in the southeast plains to over mm in the central hills. Population density, cultivation intensity, and natural vegetation type are largely controlled by the precipitation gradient: the densest settlement and most intense cultivation are in the once-forested central hills, while the lower, drier grassland plains are sparsely settled and are mainly for grazing.

Evaluation of erosion processes over this large, diverse area was possible using the Systematic Reconnaissance Flight (SRF) survey technique described in a companion paper in this volume (Norton-Griffiths 1982). Such a survey is conducted using a single-engine airplane which flies systematic transects across the area of interest. Observers on each side of the plane count livestock within 150-m wide strips, and at fixed intervals vertical photographs are taken for later analysis of the percent of area cultivated under various crops, conservation methods employed, housing density, frequency of 'erosion events' such as gullies,

and similar parameters. The survey thus provides information on the distribution and frequency of various erosion processes as well as providing comparable information on the land use characteristics which influence the occurrence of the erosion processes. Because the sample sites may be located precisely, ancillary data such as local hillslope angle, slope aspect, and annual precipitation may also be identified for each site from published sources. In Machakos, the SRF survey was flown in February and March, 1981. Transects were spaced at 1.5 or 3.0 km, depending upon the intensity of land use, and photographs were taken at about 1 km intervals from an average height of 120 m. Each photograph covers a 4-ha area and was analyzed at a scale of 1:750.

Time and budgetary constraints prevented the establishment of a monitoring program to measure process rates, so this part of the analysis depended upon published measurements from similar areas. Reconnaissance-level field work was carried out in the study area to provide a means of assessing the applicability of the published or computed rates. In addition, some measurements have been made by other workers in the district (see, for example, Edwards 1977, Moore 1979, Thomas 1974, and Thomas et al. 1981).

Preliminary examination of the SRF photographs disclosed three major sources of sediment: gullying, sheet erosion and eroding stream banks. Of these, sheet erosion and gullying were seen to be the most significant in terms of the constraints they put upon land use and were thus concentrated upon during the study.

Gully Erosion

Gullying is the most evident of the processes considered and was easily identified on the SRF photographs. Gullies were counted on each photograph and the resulting values transformed to densities, which were then mapped over the study area. As expected, the area of most intensive gullying is in the central hills (see Figure 4a), which is also the area of highest rainfall,

steepest slopes, densest population, and most intense cultivation. Because gully frequency may be expected to be positively correlated to any one of these variables and none is independent of the others, it will be necessary to hold the values of all but one constant if the relationship between gully frequency and that variable is to be examined. Of particular concern were the association of gully frequency with hillslope gradient, land use (grazing or cultivation), and conservation methods; the study also outlined associations with soil type and agro-climatic zone, but these will not be described here.

It should be stressed that the identification of an association between gully frequency and a particular variable does not imply a causal relation between the two, and even if a causal relation is present, the direction of causality is not always evident. The issue is further clouded in this case because many of the gullies in Machakos District are essentially fossilized, having shown little or no headward growth since the 1940's (Thomas 1974). Associations valid today may not have been significant when gullies were actively forming 50 years ago. Despite these problems, the identification of associations is useful both in providing a description of the current distribution of gullies with respect to land use and in identifying relationships which further work may prove to be causal.

Of primary concern was the characterization of the type of land use with which gullies are associated. A general classification of gully type demonstrates that very few of the identified gullies are located on cultivated land (see Table 1). Most are on grazing land, while a lower percentage is associated with roads or paths. It is probable that this association is actually stronger than indicated, because the growth of a gully tends to obliterate evidence of the path on which it started growing, and in the following calculations road-related gullies are classified as occurring either on cultivated or on grazing land; streambank gullies are subdivided in the same way. In addition, if cultivation appears in the same SRF photograph as the gully, the gully is considered to be associated with cultivation. This change was made because farmers tend to shift the margins of their fields

to exclude gullies. The relatively high frequency of gullies on grazed land persists despite these redefinitions. The relationship was further tested while holding soil type, agroclimatic zone, and slope constant, and in each case remains valid (see Figure 2, for example). As pointed out above, a causal relation may not be inferred from this evidence alone, and even if it could its nature is ambiguous. Gullies may be most frequent on grazed land, for example, because farmers tend to abandon gullied fields.

A second relationship, however, tends to support a direct causal relation between grazing and gully formation: gully frequency increases with stocking rate on grazed lands (see Figure 3). Although the small sample set (each point represents an average of 8 gullies) means that the lines are not significantly different from each other at the 95% confidence level, the pattern is consistent and suggestive. Further work is necessary to evaluate the reasons for this association, but the high frequency of track-related gullies and the high density of paths on heavily-grazed lands suggests that the lowered infiltration rate on compacted soils and the subsequent channelling of the excess runoff on the path surface may play an important role in gully initiation. In addition, rainfall simulation experiments conducted on grazed lands in Kajiado District demonstrate that trampling increases the erodibility of the soil by destroying its structure (Dunne 1977).

Data from the SRF survey were also used to evaluate the effectiveness of terracing in preventing gully formation. A simple regression of gully frequency versus slope for terraced and non-terraced fields does not work in this case because farmers tend to build terraces in areas that already have erosion problems. Instead, the four crop types for which adequate data exist were ranked by frequency of gullying associated with those fields. Gully frequency in each case was normalized with respect to hill-slope angle by dividing through by the average frequency of gullies on all crops on a given hillslope angle to account for the fact that some crops are likely to be grown on steeper slopes than others. The crop types were then ranked a second time according to frequency of terracing, again normalized by slope, and a Spearman rank corre-

Table 1. Gully distribution by type in Machakos District, Kenya

| <u>Gully type</u> | <u>Percent of total</u> |
|-------------------|-------------------------|
| Grazed land | 45 |
| Road-related | 28 |
| Streambank | 24 |
| Cultivated land | 3 |

Source: Own compilations.

lation performed on the two sets of rankings. The result is a perfect negative correlation: those crops which are most conscientiously terraced have the lowest gully frequencies (see Table 2). In this ranking, gully frequency is lowest and terrace frequency highest on coffee fields, which are always grown commercially. Single-cropped maize is second in terrace frequency, and represents a crop which is dominantly commercial; single-cropping implies the use of mechanical cultivation, which is rarely available to subsistence-level farmers. The third category, fallow fields, occurs both in commercial and subsistence farms, while intercropped maize fields generally represent subsistence-level farming. Thus, once again, the causal relation is elusive: the association of gullies with unterraced fields may just reflect the dual effect of the greater availability of capital with which to construct terraces on commercial farms, and the tendency of commercial farmers to avoid gullied land.

Rates of sediment production from gullying were difficult to determine from the SRF photographs because the current state of activity of the gullies could not always be recognized. Work by Thomas (1974) suggests that many of the gullies in central Machakos were initiated in the 1930's and had reached their maximum extent by about 1948; since then the gullies have only been widening. A maximum current rate of sediment production was thus estimated by dividing total gully volume by the age of the gullies, estimated to be 50 years. Field measurements were used to define a relationship between gully width and depth, which could then be applied to gully dimensions measured on the

SRF photographs to calculate an average gully volume. It was felt that the quality of the data did not justify a more precise definition of sediment production rates and their spatial variation, so the average gully volume was multiplied by the measured gully densities to produce a map of estimated sediment production rate from gullies (see Figure 4a). Direct measurement of rates of back-wasting on gully walls would be easy to make using measurements of root exposure; some such approach would be necessary to define the present erosion rates more accurately.

Table 2. Rankings by gully frequency and by frequency of soil conservation structures among different crop types

| Crop type | Gully frequency | | Frequency of soil conservation structures** | |
|-------------------|-------------------|------|---|------|
| | observed/expected | rank | observed/expected | rank |
| Coffee | 0 | 4 | 1.43 | 1 |
| Single-crop maize | .87 | 3 | 1.03 | 2 |
| Fallow | .97 | 2 | .96 | 3 |
| Inter-crop maize | 1.15 | 1 | .90 | 4 |

* expected value is the average for all crop types, as normalized by slope

** data for slopes of less than 2% are not included.

Sheet Erosion

The second erosional process of major concern in Machakos District is sheet erosion, the gradual washing away of the soil surface by overland flow. This process is most active on areas devoid of vegetation cover, such as roads or paths, cultivated land, and heavily grazed land. The presence of the sheet erosion was not always evident on the SRF photographs, although in the field the presence of lag deposits of sand on the soil surface, erosion pedestals around plants, and small-scale rilling showed it to be active at all sites visited. Rates and distribution of sheet erosion was not calculated in this study.

sheet erosion were thus calculated using the Universal Soil Loss Equation (USLE). A similar approach has been used by Daines et al. (1978), Moore (1979a), and Thomas et al. (1981) at various sites in Machakos District.

The USLE is an empirically defined relationship between the rate of sheet and rill erosion and the physical and biological factors controlling that rate, and is based on over 10,000 plot-years of data collected in North America. Calibration experiments in East Africa, however, are few, and critics of the technique numerous. Workers in Zimbabwe, for example, suggest that the North America data do not adequately account for the erosion caused by short, high intensity tropical rains, and that some clay-rich tropical soils have no counterparts in the United States (Wendelaar 1978). In addition, many of the local tillage methods, crops, and cropping patterns are unknown in the States, and thus have not been calibrated.

For the current purposes, however, determining the precise value of the sediment production rate at a site is not important. Rather, the relative significance of different sources of sheet erosion and the relative severity of erosion at various sites is of greatest interest, and for this the USLE is quite adequate. Dunne et al. (1981) have demonstrated that the USLE predicts the ranking of erosion severity to the 0.05 level of confidence among the very erosion plots on which the Zimbabwe critique is based. In addition, conditions in Machakos District are favorable for the application of the equation. The character of the rainfall is relatively uniform over the area, so inaccuracies in its description will not affect the relative values of calculated erosion rates. Furthermore, the most important soil types in the most severely eroded area are loamy to sandy soils formed on Basement Complex rocks; not only are these textures ones for which the USLE has been shown to be accurate (Wischmeier and Smith 1978), but many of the soils fall into general classifications which have been tested in the United States. Representative tropical soils of other classes such as vertisols and oxisols have now been calibrated under field conditions (Wischmeier and Smith 1978), and these data were used where applicable. Finally, the range in

tillage methods and crop types present in Machakos District provides only minor perturbations in the general patterns of erosion severity; its effect is overshadowed by other more significant influences on erosion rate in the area.

A full description of the USLE is presented in Wischmeier and Smith (1978); Wenner (1980) describes its application to soil conservation in Kenya.

The equation, $A = RKLSCP$ relates the rate of sheet and rill erosion (A, tons/acre) to an index of rainfall character (R, here calculated using the method presented in Moore 1979b), an index of soil character (K, here calculated from soil analyses presented in Sketchley et al. 1978; calculated values agree closely with measured values for similar soils presented in Wischmeier and Smith 1978), a hillslope length factor (L, here calculated from measurements of drainage density), a factor reflecting hillslope gradient (S, here measured from 1:50,000 scale topographic maps), a cropping factor (C, here evaluated using tables in Wischmeier and Smith 1978, and estimates of ground cover presented in Dunne et al. 1981), and a management index (P, evaluated for terraces using tables in Wischmeier and Smith 1978).

The study area was divided into 5 km by 5 km grid cells, and the SRF data were used to estimate the proportion of each cell under forest, grazing land, and a variety of crop types. An average value for each of the parameters described above was measured for each grid cell, and the results used to calculate the total amount of sediment eroded from land in each classification in each grid square. Values for the various crop types were summed to provide a value for cultivated land (see Figure 4c); the distribution of sheet erosion on grazed lands is shown in Figure 4d.

Comparison of field measurements and calculated erosion rates on unpaved roads in north-western North America shows that the USLE provides reasonable estimates of sheet erosion on roads which are not heavily armored with lag deposits of gravel

(Reid 1981). On this basis the USLE was also used to calculate erosion rates on the Machakos road surfaces. Road and path densities were measured on 1:20,000 scale aerial photographs for representative grid cells. Slope lengths along the road surfaces were then measured using a stereoscope, and average gradients measured on topographic maps. Application of the USLE then produced the map shown in Figure 4b.

Figure 4 demonstrates that in each case the highest erosion rates are found in the central hill region. The figure also shows that the single most significant source of sediment is sheet erosion on grazing lands. However, on average only 15% of Machakos District is cultivated; grazing lands dominate sediment production only because they are areally dominant. In addition, the calculations for cultivated land were made assuming the fields to be terraced, as the majority in Machakos District are. Were terracing not present, values for erosion from cultivated land would be about 10 times higher than those shown.

Discussion

If the data from a single grid cell are re-examined in terms of sediment yield per unit area of a given land use, the difference between the dominant source and that undergoing the most severe erosion becomes clear (see Table 3). Although grazing lands are the dominant of the three sources of sheet erosion in the grid square (the average of 73% of each ha of grid square which is occupied by grazing land produces 12 t/yr), the rate of sheet erosion per unit area of the land use in question (in this case, 18 t/yr per ha or grazing land) is not the highest of those considered. The most severe erosion, on the other hand, is on the road surfaces, despite the fact that their average gradient is only half that of the surrounding cultivated and grazed lands. These values may be compared with a loss rate of 0.6 t/ha-yr calculated using the USLE for the same area under the natural forest vegetation that was present before settlement.

In areas of over 13° average gradient and relatively high annual precipitation, erosion rates on well-terraced maize fields

are higher than those on grazed slopes. These conditions are common in the central Machakos hills. Here ground cover density is high on grazed lands even at the end of the dry season; measured values in the area ranged between 30% and 50% in September, 1981. If loss rates significantly higher than the calculated 18 t/ha-yr occurred, then erosion pedestals would be visible even on annual grasses and herbs. No such pedestals were observed, except on gully walls and in association with paths. In drier areas with lower minimum cover densities on grazed lands, the intensity of sheet erosion on grazed lands is expected to increase relative to that on maize fields. In addition, gullies are generally associated with grazed lands and must be taken into account if an

Table 3. Calculated sheet erosion from different types of land use in the central Machakos hills, and corresponding erosion rates per unit area of the given land use. Values are subject to rounding error.

| Type of sheet erosion | Percent of area in use category | Loss rate, with given distribution of land use in area* (t/ha/yr) | Erosion rate per unit area of given land use (t/ha/yr) |
|-----------------------|---------------------------------|---|--|
| Road surface | 2 | 3 | 310 |
| Cultivated land | 23 | 3 | 12 |
| Grazed land | 73 | 12 | 18 |

*A value of 3 t/ha/yr for cultivated land thus implies that the 0.23 ha of cultivated land per ha of land in the area produces 3 t/yr.

overall comparison of sediment production from grazed and cultivated land is to be made.

The difference between the dominant sediment source and the most severely eroded source leads to the necessity of defining the 'significance' of a sediment source in terms of a specific type of land use. For example, if the rate of sedimentation in

local reservoirs is of concern, then the most important source of sediment is clearly sheet erosion on grazed lands. On the other hand, if concern is focused upon an abnormally high rate of soil thinning of a maize field in central Machakos, then it might make sense to convert that site to grazing land. And if structural damage caused by erosion is a topic of worry, then the most significant erosion process is gullying, despite the fact that gullying contributes the least amount of sediment of the sources considered.

This study was described as a reconnaissance survey, and as such, it has covered an extremely wide area rather superficially. The major value of such a study is not the estimates of erosion rates which it produces; these numbers are useful only in indicating the order of the actual loss rates and in providing a means of comparing the effects of different sediment sources. Rather, the study's value lies in its ability to expose large-scale patterns in the distribution of erosional processes, both spatially and in terms of the association of process with land use and physical parameters. The study thus provides the basis for designing long-term monitoring programs by 1) indicating which processes are in need of monitoring, 2) showing where these processes occur, and 3) defining associations which may, with further study, illuminate the specific causes of the erosion problems. Even if further studies are not carried out, reconnaissance surveys are a useful means of determining where erosion control measures are most needed and which sources are in most need of control.

REFERENCES

- Daines, S.H.; Njoroge, P. and Njui, K. 1978. Kenya marginal/semi-arid lands pre-investment inventory report no. 4: Soil and water management. Prepared for the Government of Kenya by the Consortium for International Development, the U.S., Soil Conservation Service, and the staffs of the Ministries of Agriculture, Water Development, and Natural Resources, Kenya.
- Dietrich, W.E.; Dunne, T.; Humphrey, N.F. and Reid, L.M. In press. Construction of sediment budgets for catchments. In Proceedings of a Symposium on Sediment Budgets and Routing in Forest Catchments, 1979, Oregon State University, Corvallis, Oregon, U.S.A.
- Dunne, T. 1977. Intensity and controls of soil erosion in Kajiado District. Report to the Kenya Wildlife Management Project, Ministry of Tourism and Wildlife, and FAO, Nairobi.
- Dunne, T.; Aubry, B. and Wahome, E.K. 1981. Effect of woodfuel harvest on soil erosion in Kenya. Report to Ministry of Energy, Nairobi.
- Edwards, K.A. In press. Regional contrasts in rates of soil erosion and their significance with respect to agricultural development in Kenya. In Greenland, D.J. and Lal, R. (editors) The Role of Soil Physical Properties in Maintaining the Productivity of Tropical Soils. John Wiley, London.
- Moore, T.R. 1979a. Land use and erosion in the Machakos hills. *Annals of the Association of American Geographers* 69(3): 419-431.
- Moore, T.R. 1979b. Rainfall erosivity in East Africa. *Geografiska Annaler* 61A(3-4): 147-156.
- North-Griffiths, M. 1982. Application of low-level aerial survey to studies of soil erosion. In Proceedings of the Soil and Water Conservation Workshop, Faculty of Agriculture, University of Nairobi, Kenya, 1982.
- Reid, L.M. 1981. Sediment production from gravel-surfaced forest roads, Clearwater Basin, Washington. Report to the University of Washington Fisheries Research Institute, FRI-UW-8108.
- Sketchley, H.R.; Mbuvi, J.P. Scilley, F.M. and Wokobi, S.M. 1978. Kenya marginal/semi-arid lands pre-investment inventory report no. 10: Soils. Prepared for the Government of Kenya by the Consortium for International Development, the U.S. Soil Conservation Service, and the staffs of the Ministries of Agriculture, Water Development, and Natural Resources, Kenya.

Thomas, D.B. 1974. Air photo analysis of trends in soil erosion and land use in part of Machakos District, Kenya. Thesis submitted to University of Reading, England.

Thomas, D.B; Edwards, 1981. K.A. Barber, R.G.; and Hogg, I.G. Runoff, erosion and conservation in a representative catchment in Machakos District, Kenya. In Lal, R. and Russell, E.W. (editors), Tropical Agricultural Hydrology. John Wiley, London.

Wendelaar, F.E. 1978. Applying the Universal Soil Loss Equation in Rhodesia. Mimeographed report, Soil and Water Engineering Section, Institute of Agricultural Engineering, Rhodesia. 24 pp.

Wenner, C.G. 1980. Soil Conservation in Kenya. Land Resource Development Division, Ministry of Agriculture, Nairobi. pp. 205.

Wischmeier, W.H.; and Smith, D.D. 1978. Predicting rainfall erosion losses - a guide to conservation planning. U.S. Department of Agriculture, Agriculture Handbook no. 537.

Fig. 1 Location of Machakos District Kenya.

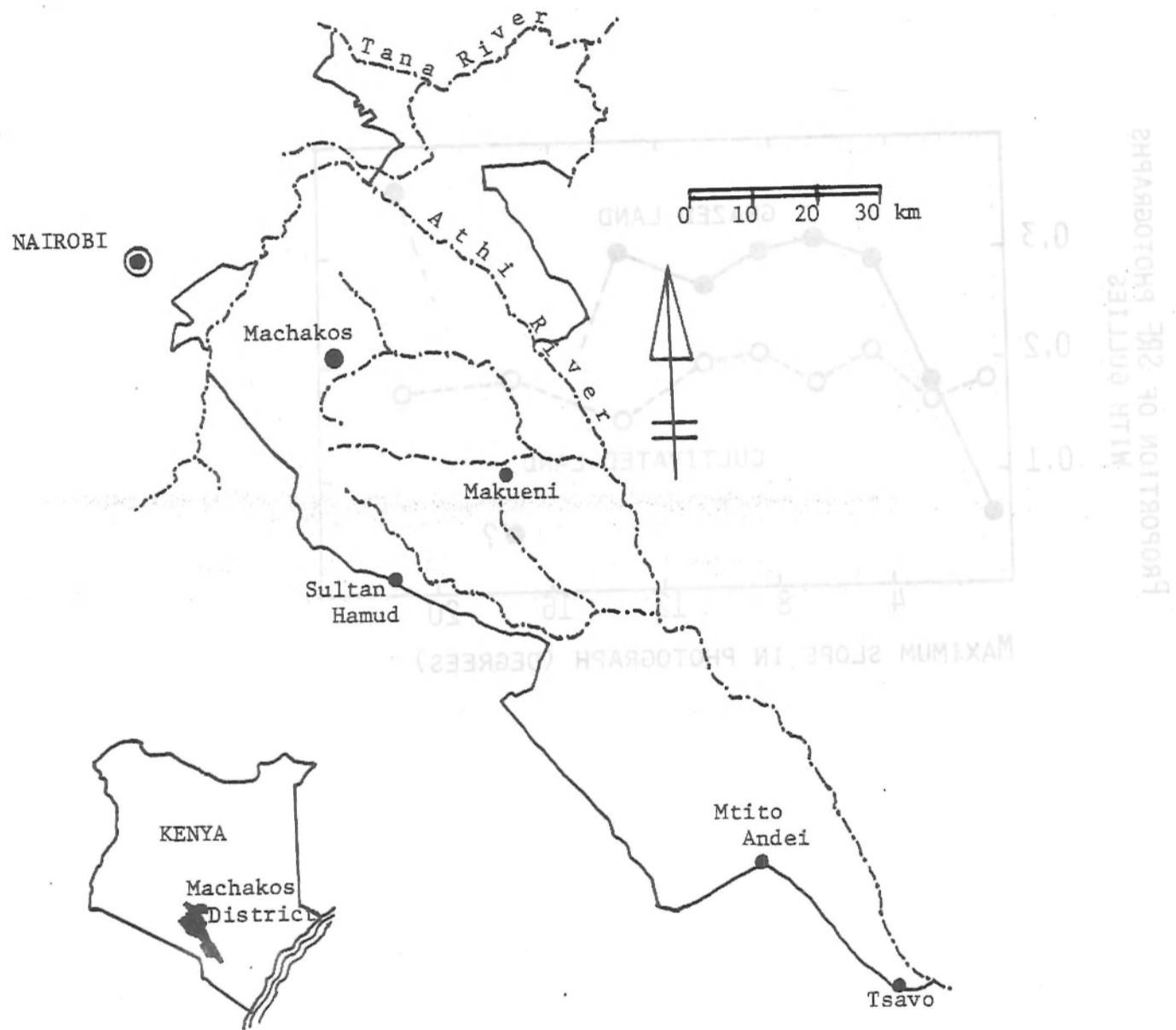

Fig. 2 Gully frequency versus hillslope gradient for grazed and cultivated land.

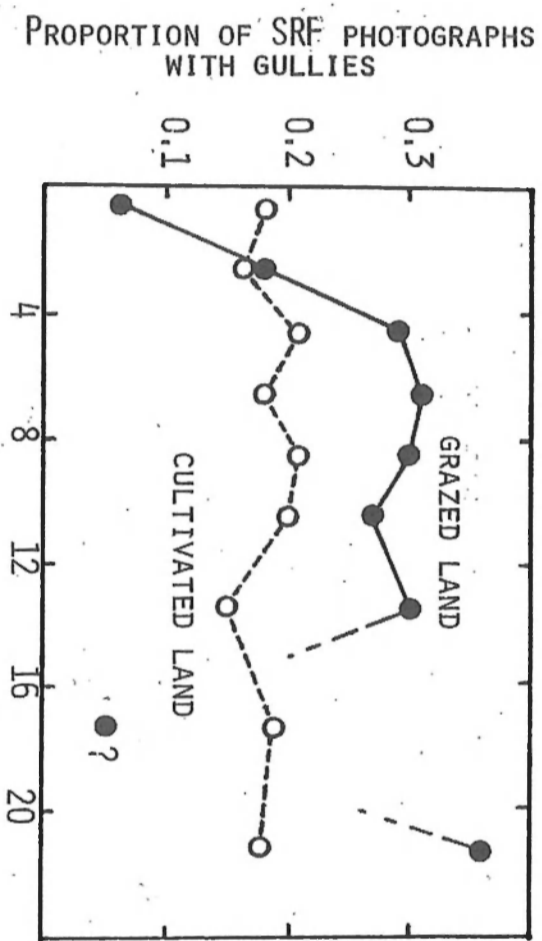

Fig. 3 Gully frequency versus hillslope gradient for various stocking rates on grazing lands - Curves fitted by eye.

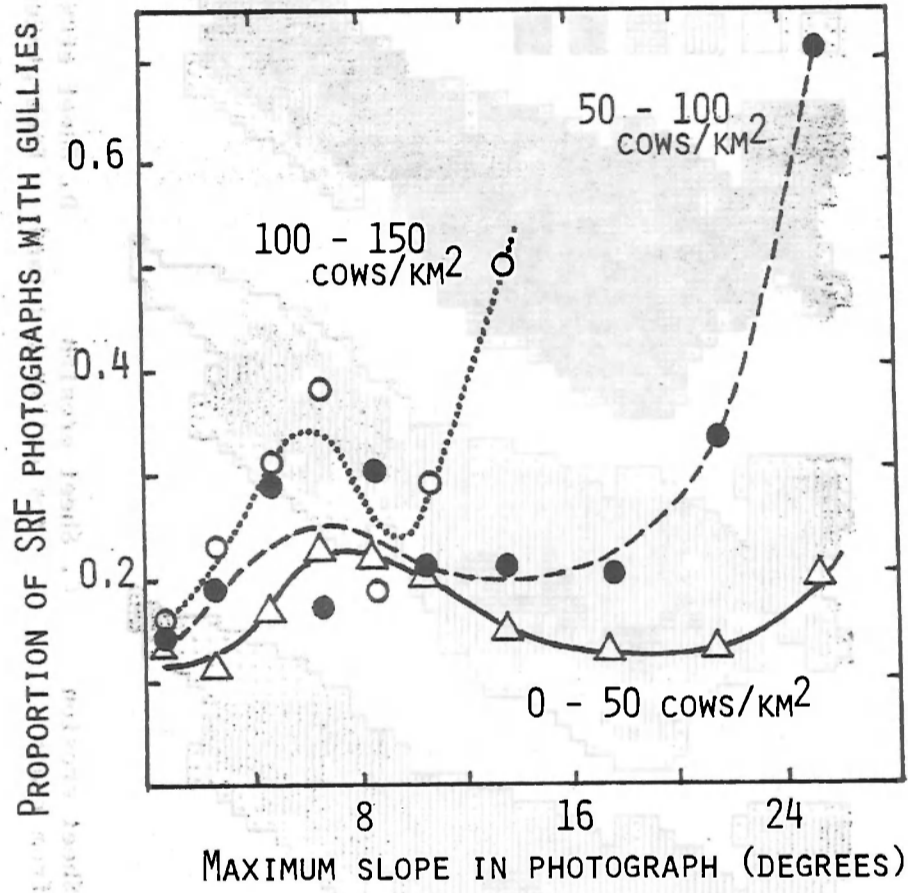
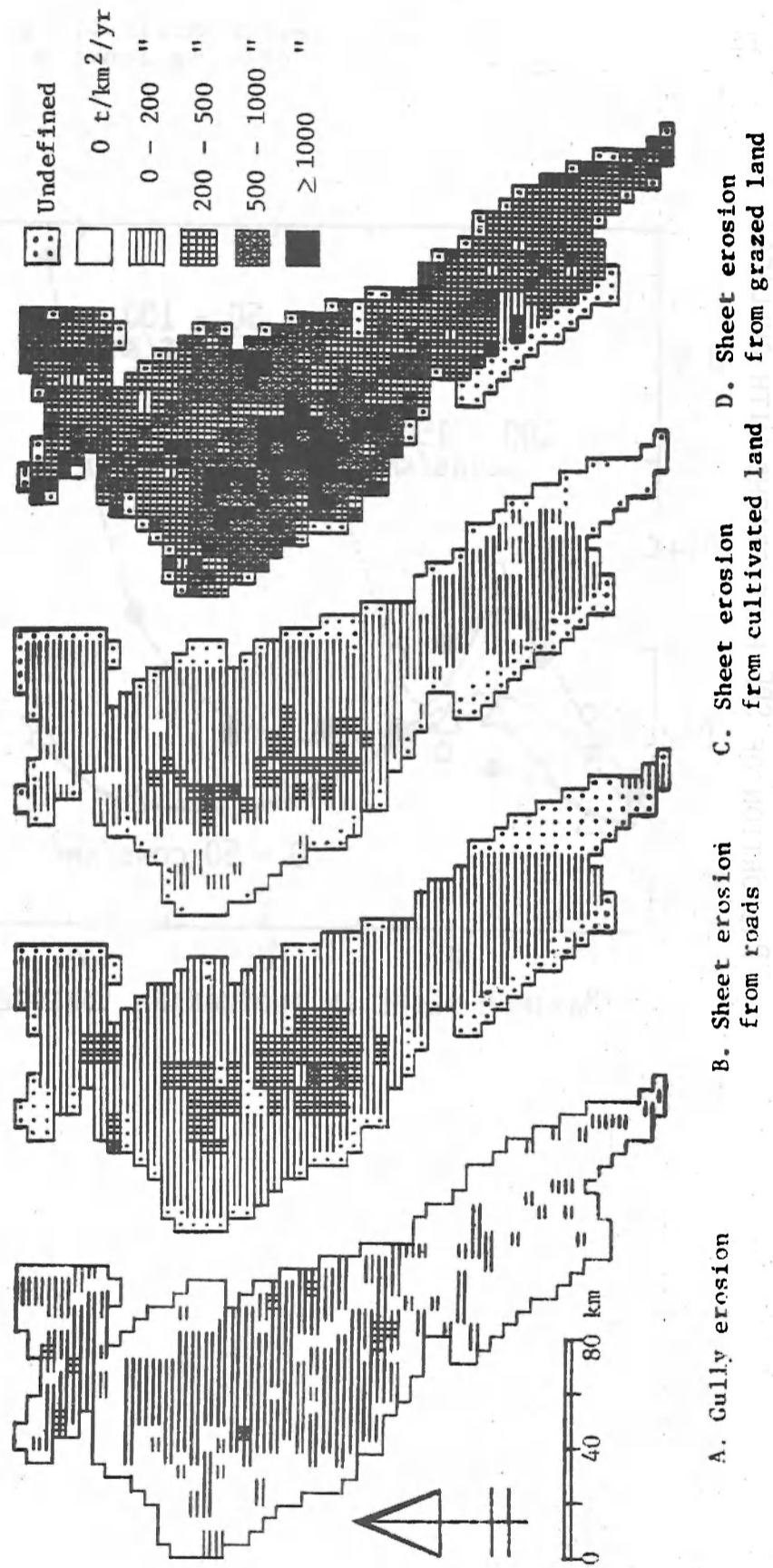

Fig. 4 Contribution from different sediment sources to total sediment production rate. Values are based on an estimate of the sediment production by a given source in each 5x5 km² grid cell divided by the total area of the gridded cell.



A. Gully erosion B. Sheet erosion from roads C. Sheet erosion from cultivated land D. Sheet erosion from grazed land

APPLICATION OF LOW LEVEL AERIAL
SURVEY TO STUDIES OF SOIL EROSION

By

M. Norton-Griffiths
EcoSystems Ltd., Nairobi

INTRODUCTION

The rate at which soil erodes is a function of many interrelated factors, including the nature of the soil itself, the nature of the topography, the intensity, duration and amount of rainfall, and the cover of the natural vegetation.

The impact of human use on the land is to modify these controlling factors so that erosion rates become accelerated. Cultivation strips off the protective vegetative cover and exposes bare soil to the first rains of the season. Felling of woodlands similarly exposes soil to the erosive influences of rainfall, while heavy grazing pressure from stock denudes natural cover. Bare tracks made by people and their stock concentrate run off so that gullies form, as do poorly maintained road networks.

However, the impact of human land use on erosion rates can be minimised by careful land husbandry. Thus terraces reduce slope angles and therefore the speed with which water runs off. Contour ploughing (as opposed to ploughing up and down slopes), ridging, tied ridging and contour bunding all reduce slope lengths and therefore also the speed with which water runs off. Careful stock management can maintain high stocking levels and good plant cover. Well designed and maintained roads, culverts and drainways will minimise damage from gullying. And a judicious selection of crop types, including tree crops, can, with careful management, maintain some plant cover throughout the year.

The aim of soil conservation programme is to modify human land use so that their impacts on soil erosion are reduced. However, to do this, information is needed on

the sources of soil loss, on the processes causing the soil loss, and on the associated land use parameters.

Although field measurements can provide accurate and precise data on the rates of soil loss through different processes (sheetwash, gullying etc.) and from different sources (cultivated land, rangeland, roads etc.), it is extremely difficult to obtain good data from ground surveys on the proportion of land taken up by different land uses. To quantify land use parameters we need to know within a spatial framework the proportion of land taken up by:-

- Cultivation : broken down by type of cultivation (e.g. terracing, flat fields, ridged fields etc.) and by crop type and crop combination.
- Rangeland : broken down by areas under different stocking densities.
- Vegetation Cover : broken down by woody, bush and herbaceous.
- Infrastructure : broken down by roads and tracks, compounds, and bare areas around settlements.

Armed with such information, and with field measurements of the sediment yields associated with each of these parameters, it is possible to calculate a sediment budget for an area. And, as Leslie Reid explains in her contribution to this workshop, the sediment budget is the first step in designing and implementing soil conservation strategies.

THE SYSTEMATIC RECONNAISSANCE FLIGHT

Over the past few years, we have developed and refined a method for quantifying the spatial distribution of land use parameters by a combination of visual observations and vertical photography from low flying, light aircraft. Known as the Systematic Reconnaissance Flight (SRF), the method had its origins in the study of the seasonal migrations of wildebeest in the Serengeti ecosystem, Tanzania, and the associated changes in range quality, water availability and fire.

The SRF is a sampling method whereby an aircraft flies parallel transects across a study area at a ground speed of around 160 kilometres per hour and at a height of some 400 feet above ground level. Visual observations are recorded continuously along the length of each transect, but are divided into successive 'sub-units' on the basis of elapsed time (e.g. 30 seconds) or elapsed distance (e.g. five kilometres). One or more vertical, sample photographs are taken within each sub-unit, and all data recorded during the survey are cross referenced to an individual transect/sub-unit.

The sampling intensity is set by the spacing of the transect which is itself a compromise between the amount of money available for the survey, the size of the study area and the desired precision of the survey estimates. Typically, a ten kilometre spacing will be used for large areas and a tighter spacing for smaller areas.

The survey height is also a compromise between the requirement for the observers to be able to locate and count objects accurately and the area that can be photographed from a vertically mounted camera. A height of 400 feet above ground level is a widely accepted compromise. At this height counting bias is acceptably low (and can be corrected for) while a super wide angle lens photographs a sample area of around 4 hectares. The pilot controls height along the transects by reference to a radar altimeter which gives a continuous read out of height above ground level.

The survey speed is yet another compromise between cost and observer counting bias. A ground speed of 160 kilometres per hour is widely used, and experienced observers have no difficulty in locating and counting objects at this speed.

The key to the SRF method is the accurate navigation of the aircraft along the selected transects. Although navigation is always carried out by reference to maps and ground features, sophisticated navigation systems now provide the capability to maintain very accurate spatial orientation. We use the GNS500A navigation computer which tunes into a worldwide network of sixteen very low frequency radio beacons (the OMEGA/VLF network). The system has an operational accuracy of 0.1 nautical miles (185 metres) and provides the pilot with continuous position information in addition to other important data such as ground speed.

By controlling both flight line orientation and ground speed accurately, each sub-unit along the transect can be accurately located in space. The SRF therefore yields a set of data points each of which can be accurately georeferenced.

An SRF survey is almost always carried out within the framework of a sampling grid, and each data point (sub-unit) is assigned to an individual grid cell. The (UTM) Universal Transverse Mercator is widely used for such sampling frames, for it is a world wide standard grid system which is projected onto many maps, and which can be projected easily onto aerial photographs or other cartographic/thematic data sources.

Figure 1 shows the eastern part of Shinyanga Region, Tanzania, which was surveyed in October 1981 using the SRF method. The 10 kilometre UTM grid system has been projected onto this base map. Figure 2 shows the orientation of the transects on this SRF survey. The transects were spaced at 10 kilometre intervals across the whole of the 24,000

square kilometre study area, and each sub-unit was 1.3 kilometres in length (30 seconds of flying time at 160 kph). Sampling was more intensive over the areas of excessive soil erosion, the transects being spaced at 5 kilometre intervals. 62% of the study area was therefore sampled with transects spaced ten kilometres apart and 38% was sampled with transects spaced five kilometres apart.

VISUAL OBSERVATIONS

Observers sitting in the rear seats of the aircraft continuously scan a sampling strip which is demarcated by rods attached to the aircraft wing struts. The width of the sampling strip is once more a compromise between obtaining as large a sample as possible whilst minimising observer counting bias. Experienced observers can scan a strip of 150 m width at a height of four hundred feet and at a ground speed of 160 kph.

The observers record all their observations onto tape for later transcription, along with time pulses to distinguish between successive sub-units.

Experienced observers are capable of recording a wide range of information on land use patterns, domestic stock, wildlife and erosion. In the SRF survey of Shinyanga referred to above, the observers primarily concentrated on stock, wildlife and erosion.

Cattle, sheep and goats, donkeys and eighteen species of wildlife were tallied on a sub-unit basis, any large herd of animals being photographed for accurate recounting at a later date. Sheep and goats were counted as a combined category due to the difficulty of discriminating each type of animal within their mixed herds.

A wide range of erosion phenomena were also counted within the 150 m sampling strips either side of the aircraft. Sheetwash, gully incidence and character, streambed and stream-bank conditions, and the presence of rilling on roads, fields and open rangeland were all quantified.

Sheetwash erosion was recognised to be active on areas without vegetation or with only sparse vegetative cover, and which showed evidence either of armouring by coarse sediment or of flow concentrations on non-channelled slopes. The relative severity of the erosion was noted, as was its association with rangeland, cultivated land or towns. Rilling was frequently seen in areas of extreme sheetwash, and the number of rill systems in each sub-unit were counted. Here, too, associations with land use were noted.

Whereas rills were defined as narrow hillslope channels of less than 1 metre in width, showing either signs of recent headward erosion or fine digitate form, gullies were identified as wide channels of more than 1 metre with distinct headwalls. The gullies were further divided into those showing signs of recent erosion (e.g. those having steep, non-vegetated walls) and those which were partially healed (e.g. vegetated). Gullies too, were classified according to the land use with which they were associated, rangeland, cultivated land or roads. Where gullies existed as individual, linear features their numbers were counted; where larger areas were affected by gullying, for example a series of gully systems along a footslope of a hill, the count was given a value of 10; and where such a situation persisted for more than half of a sub-unit the count was given a value of 20.

The number of roads falling within the sample strips were counted, and each road was classified according to whether rills or gullies were present on, or were parallel to, the road alignment. Roads parallel to but within the sampling strips were counted only once per sub-unit.

Finally, eroding streambanks were evaluated using much the same technique as with roads. Streams in the sample strips were counted and were classified as non-eroding (over 75% of the bank length vegetated or at a low angle) or eroding (over 25% of the bank length near-vertical and bare of vegetation).

VERTICAL AERIAL PHOTOGRAPHY

Vertical colour photographs, taken along the length of each transect, provide the bulk of the data on land use. Typically, one sample photograph is taken in each sub-unit, although the frequency can be increased over areas of particular interest.

We use an Olympus OM-2 35mm camera equipped with 250 exposure cassettes and an 18mm lens. The field of view covers approximately four hectares at a flying height of four hundred feet above ground level, at a film scale of approximately 1/7500. The radar altimeter reading is recorded at the time of every exposure so that scale and areas calculations can be controlled for each frame individually.

The colour diapositives are analysed by projecting them vertically onto a desk top 'dot-grid', at a 10 x enlargement to give an interpretation scale of 1/750. The semi-random dot grids contain 640 dots over the area of the frame, each dot having an equivalent diameter on the ground of approximately one metre.

A wide range of land use data can be quantified from these vertical, colour transparencies, including information on the area under cultivation, the methods of land management, the types of crops being grown (this is obviously very dependent upon the timing of the survey), the nature of settlements, the ground cover of vegetation, the nature and extensiveness of erosion phenomena, and the amount of land taken up by infrastructure and support activities.

In the Shinyanga SRF survey already referred to, each photograph was analysed in four different ways. First, counts of buildings were made, separating those with **mabati*** roofs from those of traditional style roofs.

Second, dot counts were obtained for a variety of land use types in order to calculate the proportional area of each. Agricultural fields were divided into actively cultivated and currently unused fields. The active fields were further sub-divided into flat fields, ridged fields and rice paddies, and each of these were measured to determine if the field in question was larger or smaller than one hectare. The areas of public transportation arteries, pathways, buildings and yards, hedges and thorn fences, rock outcrops and drainage ways were all evaluated. Woody canopy cover was measured by counting the number of dots which intercepted the crowns of woody vegetation.

The third analysis involved the quantification of a number of erosion phenomena, in particular the area affected by gullies. This was evaluated by counting the number of dot-grid squares into which gullies intruded, each frame containing 160 squares. This gave a better measure of gully area influence than counting the semi-random dots on such a digitate and dynamic feature. Each gully was also classified by its association with roads and paths, streambanks, cultivated land or open rangeland.

Lastly, the predominant soil type of each four hectare sample was classified into one of ten soil categories.

ANCILLARY DATA

The SRF survey technique can, as we have seen, quantify the abundance and distribution of a wide range of land use parameters and erosion phenomena. However, ancillary data is almost always required to interpret the land use patterns and their associations with erosion phenomena and to interpret the causes of the erosion phenomena themselves.

*Galvanised iron roof.

This ancillary data can be obtained from a variety of sources, including topographic maps, soil maps, rainfall maps, satellite imagery, conventional aerial photography, demographic censuses and detailed field surveys. One of the most powerful aspects of the SRF survey method is that it is quite straightforward to integrate such ancillary data into the SRF data set.

In the Shinyanga SRF survey we made use of the following range of ancillary data. Mean elevation, stream density and mean slope angles were obtained from 1/50,000 and 1/250,000 scale topographic map sheets. Data on precipitation, evaporation, livestock occupation history and cattle dips were obtained from previous consulting reports from the area, as were data on soil types and characteristics. Administrative boundaries of Districts, Divisions and Wards were obtained from the Shinyanga regional authorities, along with data on human population densities. Landsat images were used to define areas of excessive land use pressure and high erosion potential, and areas in which land degradation had intensified during the eight year span of the satellite image record. Conventional black and white aerial photographs at approximately 1/40,000 scale and dating from 1964 and 1976 were used to quantify changes in agricultural land use, woody canopy cover and areas affected by gullies. Finally, field studies were carried out to measure the rates of erosion associated with the land use parameters and erosion phenomena quantified by the SRF survey.

DATA COMPILATION AND INTEGRATION

In general terms, the data collected in the course of an SRF survey, including the ancillary data, are in either 'point' form or in 'grid' form. Point data are individual samples or observations collected at a precisely determined point in space. Examples of point data include:

- the number of livestock counted by observers on the SRF survey in a defined sub-unit of a transect;
- the area of cultivated land measured from an individual vertical photograph taken in a defined sub-unit;

- ground measurements of the rates of soil loss from sheetwash erosion;
- an individual farmer interview; and
- soil type identified on an individual 35mm sample photograph.

Grid data is much more coarse and involves classifying an individual UTM grid square on some particular attribute.

Examples of grid data include:

- rainfall : each grid cell is assigned a value for mean annual precipitation, taken from a rainfall map;
- slope : each grid cell is assigned a mean slope angle, measured from topographic map sheets;
- drainage : each grid cell is given a mean value for drainage density, measured from topographic map sheets;
- elevation : each grid cell is given a mean elevation, measured off topographic map sheets; and
- previous cultivation: each grid cell is given a % cultivation area measured from existing black and white aerial photographs (note that the UTM grid must be first projected onto the airphotos).

Every sample point is assigned to a particular grid cell, and every grid cell contains a precisely determined set of sample points. Data are therefore freely transferable between points and grids, and vice versa. Thus, a grid cell can be characterised on the basis of some attribute measured at all the sample points falling within it, such as the average density of livestock, the average area of cultivated land or the dominant soil type. Similarly, all the points assigned to a grid cell can be characterised by any attribute defined for the grid cell as a whole, such as mean elevation or average annual precipitation.

Although some data types do not fall naturally into the point/grid classification, they can still be accommodated in the data set. For example : -

- Administrative Boundaries : Each point is classified according to the District/Division/Ward into which it falls.
- Landsat Image Strata : Each point is classified according to the Landsat image interpretation strata into which it falls.
- Population Data : Population census data on a Division or Ward level are entered into the data set by assigning the relevant density figures to those points already classified on a Division or Ward basis.

Once the data are compiled into point or grid form, new data variables can be calculated from any combination of original variables. Thus, the total density of livestock units can be calculated at each point and in each grid cell from the surveyed densities of cattle, sheep, goats and donkeys. Similarly, the relative change in agricultural land use can be derived from measurements off existing sets of aerial photographs. Furthermore, indices of erosion 'severity' can be created by combining all the erosion data. Figs 3-9 show how data is presented.

There are two main advantages to using a matrix of points and grid cells for the storage and presentation of data. First, the grid cell matrix lends itself to efficient mapping of data variables. The cell format provides the simultaneous depiction of both overall spatial patterns and the underlying local variations.

The second advantage of the point/grid system lies in their ease of manipulation and flexibility for computer analysis. Once the points are classified into the appropriate administrative unit or erosion category, the associated land uses within each can be analysed. Furthermore, the finer texture of the point data permits the analysis of survey data at the local scale as well as at the coarser, subregional scale of the UTM grid cell.

APPLICATION OF THE SRF SURVEY METHOD

The SRF survey is a powerful method for quantifying the abundance and distribution of resources, land use and

erosion phenomena, and for integrating a wide range of data, including ground survey data, to interpret land use patterns and the relationships between such patterns and soil erosion. It must, however, be clearly recognised that the SRF survey is only one aspect of an integrated approach to soil erosion. The advantage of the SRF method is that it can quantify land use parameters and erosion phenomena over large areas relatively quickly and at relatively low cost. The data provided by an SRF survey are effectively impossible to acquire through ground survey methods, but they cannot be interpreted in a meaningful manner without field measurements.

In our recently completed study of soil erosion in southeast Shinyanga Region, Tanzania, the SRF survey fulfilled the following important roles.

(a) Inventory

The SRF data provided an inventory of resource abundance, resource use, land use and erosion phenomena for each District and Division in the study area, including thematic maps of each surveyed attribute. These inventories provide up-to-date information on which future development and soil conservation plans can be based.

(b) Field Studies

Study Units were defined from an assessment of the regional patterns of land use and erosion. The field team was provided with both a comprehensive inventory of the patterns of land use and erosion within each study unit and a preliminary assessment of their interrelationships. The field studies were planned and implemented within these study units.

(c) Extrapolation of Field Results

The results of the field studies were extrapolated on the basis of the SRF data to interpret the regional patterns of land use and erosion.

(d) Recommendation Areas

Recommendation Areas were defined by integrating all information from regional sources, the SRF survey and the field studies. The recommendation areas were homogeneous for environmental attributes, for land use patterns and farming systems, and for the nature, extent and underlying causes of erosion. Programmes for soil conservation and rehabilitation were designed within the framework of these recommendation areas.

COSTS

The costs of an SRF survey are affected by many factors, including the size of the study area, the intensity of the sampling, the logistic difficulties and the amount of ancillary data to be accessed and integrated into the SRF survey data set. An average cost over five SRF surveys in Sudan, Kenya and Tanzania, in areas ranging from 120,000 square kilometres to 14,000 square kilometres, is US \$5.0 per square kilometre. This figure includes the survey, logistic support, data analysis and reporting, but does not include the costs of any associated ground surveys.

Conventional aerial photography currently costs about twice this on a per square kilometre basis, before any analysis or photointerpretation is carried out. The SRF survey method is therefore very cost effective.

LIST OF FIGURES

- Figure 1 : South East Shinyanga, Tanzania. A base map of the 24,000 square kilometre study area with the 10 kilometre UTM grid system overlaid,
- Figure 2 : Flight lines were run east-west across the study area to cut across the major environmental and land use gradients, Flight lines were spaced at 10 kilometre intervals over the study area, and at five kilometre intervals in areas of excessive erosion.
- Figure 3 : Administrative reporting units within the study area. District, Division and Ward boundaries are shown.
- Figure 4 : Relative change in population between 1967 and 1978, derived from population census data.
- Figure 5 : Relative change in agricultural area (active cultivation) between 1964 and 1976, derived from an interpretation of 1/40,000 scale black and white air photocoverages.
- Figure 6 : Relative change in wooded area between 1964 and 1976, derived from same photocoverages,
- Figure 7 : Gully erosion index, derived from visual observations on the 1981 SRF survey.
- Figure 8 : Sheetwash erosion index derived from same data source.
- Figure 9 : Total cultivated land in hectares per square kilometre, derived from the 35mm sample, colour photographs taken during the 1981 SRF survey.
- Figure 10 : Livestock unit density per square kilometre, derived from the visual counts of livestock during the 1981 SRF survey.

REFERENCES

Figure II : Woody canopy cover as hectares per square kilometre, derived from the 35mm sample photograph, 1981 SRF survey.

Figure 12 : Total wildlife density per square kilometre, derived from visual observations of eighteen wildlife species, 1981 SRF survey.

Beaton-Griffiths, W. (1973). Counting the kangaroo: a review of the methods used in the 1960s. *Wildlife Research*, 10, 1-14.

Beaton-Griffiths, W. (1978). Counting kangaroos (and other mammals) in the field. *Wildlife Research*, 15, 1-14.

Beaton-Griffiths, W. (1979). *Wildlife Research: A Review of the Methods Used in the 1960s*. *Wildlife Research*, 16, 1-14.

Beaton-Griffiths, W. (1981). *Wildlife Research: A Review of the Methods Used in the 1960s*. *Wildlife Research*, 18, 1-14.

Beaton-Griffiths, W. (1982). *Wildlife Research: A Review of the Methods Used in the 1960s*. *Wildlife Research*, 19, 1-14.

REFERENCES

- Gwynne, M.D. and Croze, H.J. (1975). East African habitat monitoring practice: A review of methods and application. In, Evaluation and Mapping of Tropical African Rangelands, Bamako, Mali. International Livestock Centre for Africa: Addis Ababa.
- ILCA (1981). Low-Level Aerial Survey Techniques. ILCA Monograph No. 4, International Livestock Centre for Africa; Addis Ababa.
- Norton-Griffiths, M. (1973). Counting the Serengeti wildebeest using two-stage sampling. E. Afr. Wildl. J. 11(2):135-149.
- Norton-Griffiths, M. (1978). Counting Animals (end ed.). African Wildlife Leadership Foundation: Nairobi.
- Sinclair, A.R.E. and Norton-Griffiths, M. (1979). Serengeti: Dynamics of an Ecosystem. Chicago University Press: Chicago.

SOUTHEAST SHINYANGA REGION

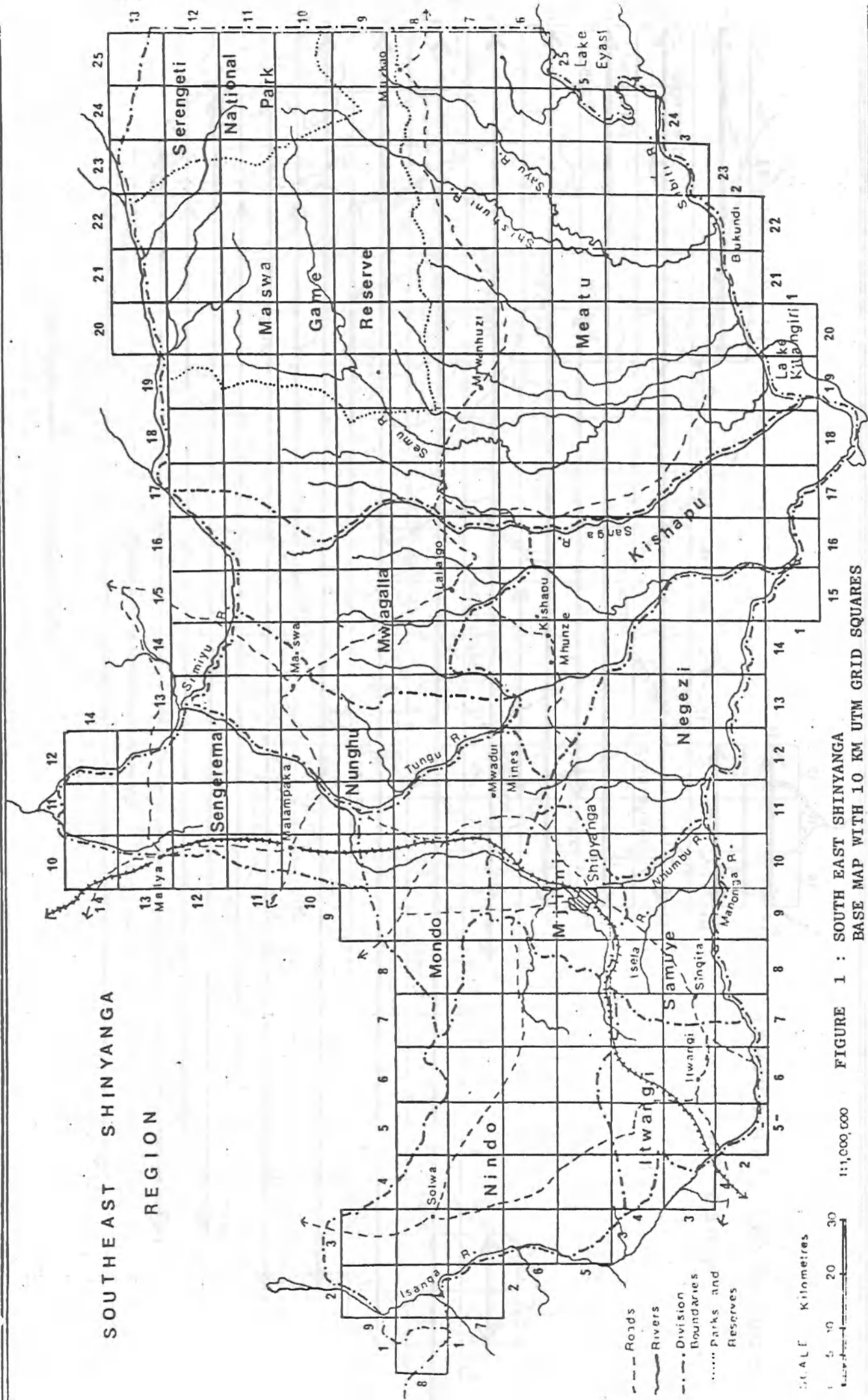

SOUTHEAST SHINYANGA
REGION

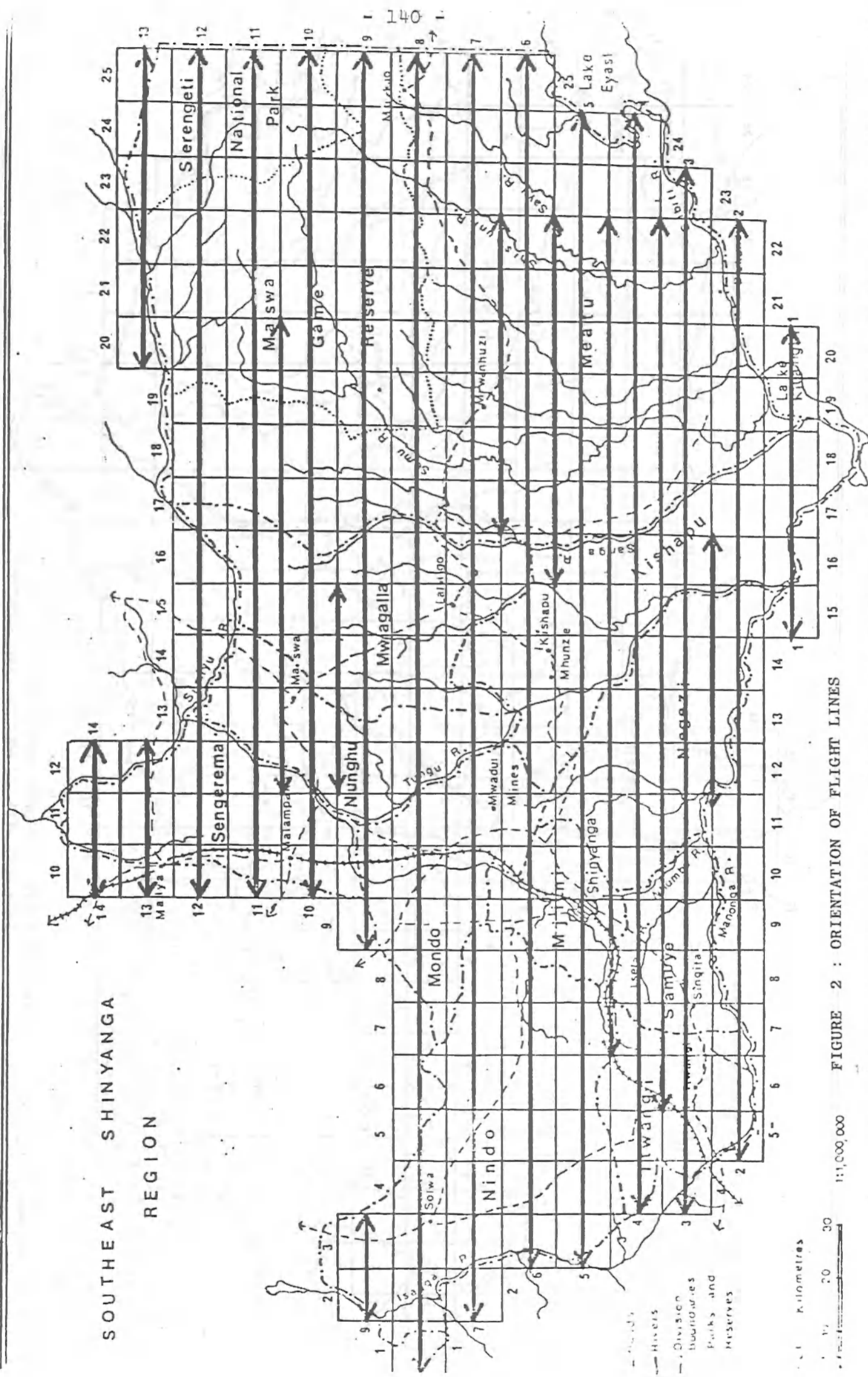

FIGURE 2 : ORIENTATION OF FLIGHT LINES

1:1,000,000
Kilometres
0 20 30

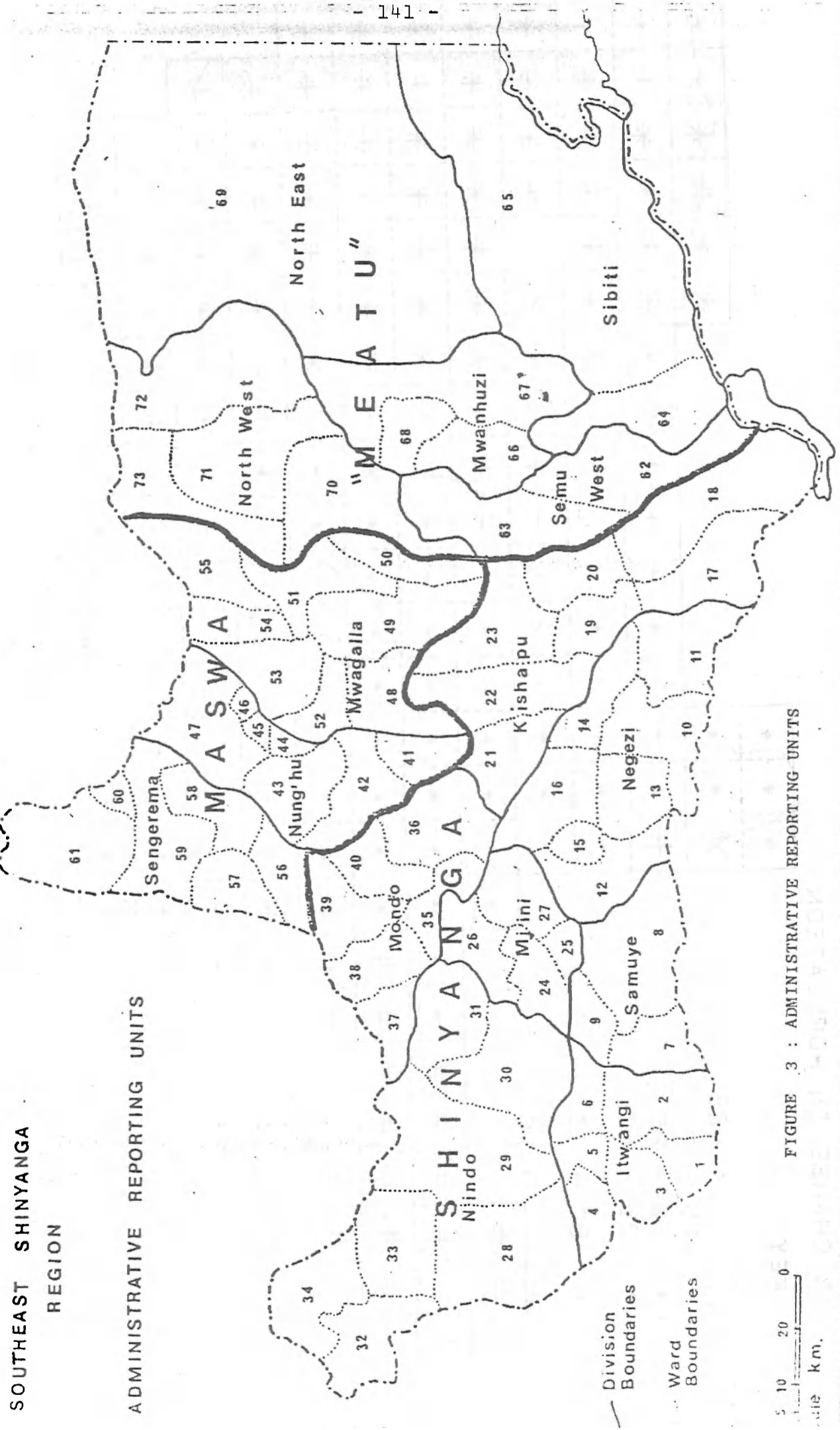

FIGURE 3 : ADMINISTRATIVE REPORTING UNITS

SOUTH-EAST SHINYANGA REGIONAL SURVEY NOVEMBER 1981

% CHANGE IN POPULATION

14 KEY

- 13 X < -25
- 12 - -25 - 0
- 11 + 0 - 25
- 10 * 25 - 50
- 9 * 50 - 75
- 8 # > 75

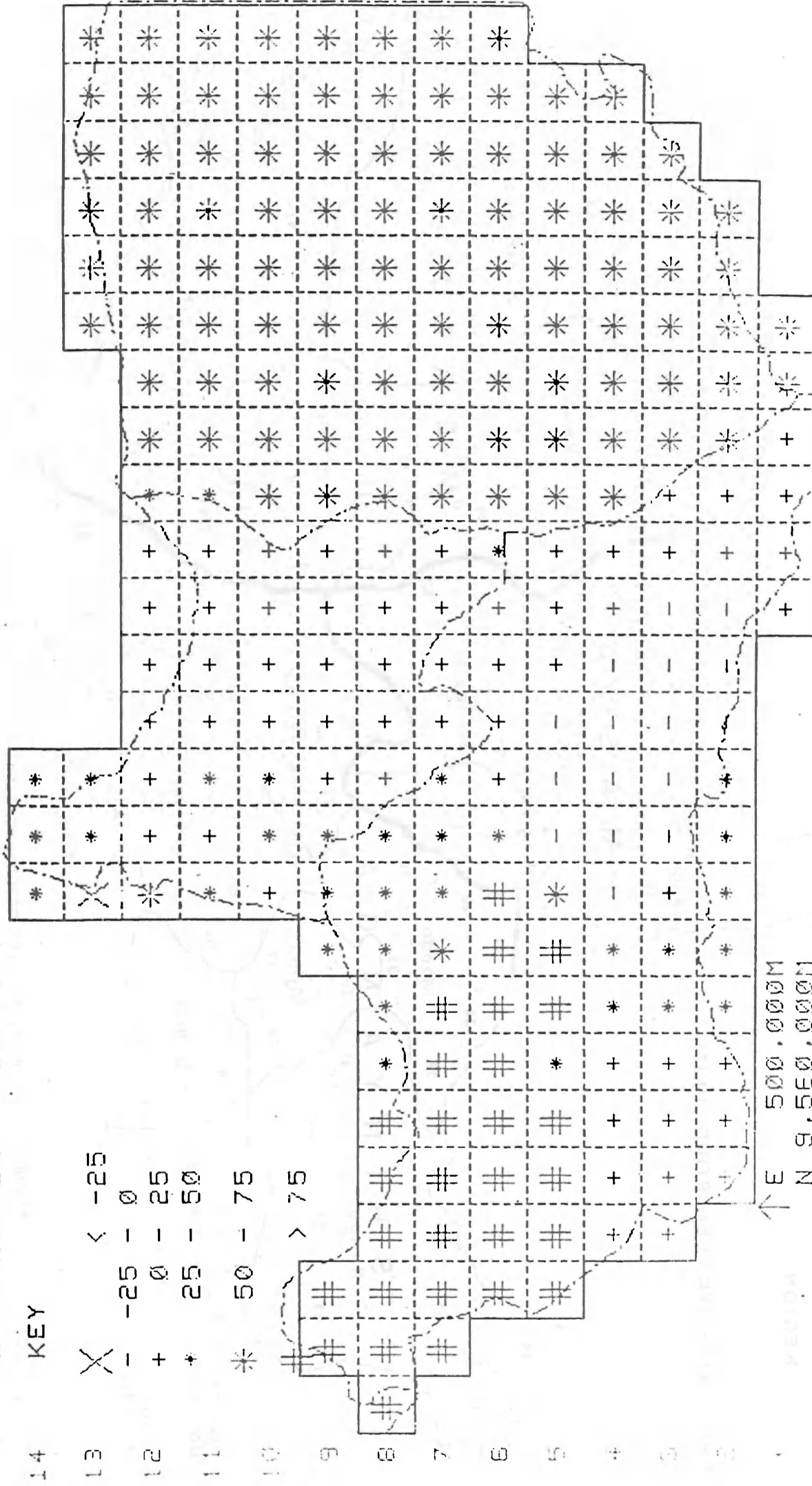

E 500,000M
N 9,5E0,000N

FIGURE 4: RELATIVE CHANGE IN POPULATION, 1967 - 1978

SOUTH-EAST SHINYANGA REGIONAL SURVEY NOVEMBER 1981

% CHANGE IN INDEX

14 KEY

- 13 X < -25
- 12 - -25 - 0
- 11 + 0 - 25
- 10 * 25 - 50
- 9 * 50 - 75
- 8 # > 75

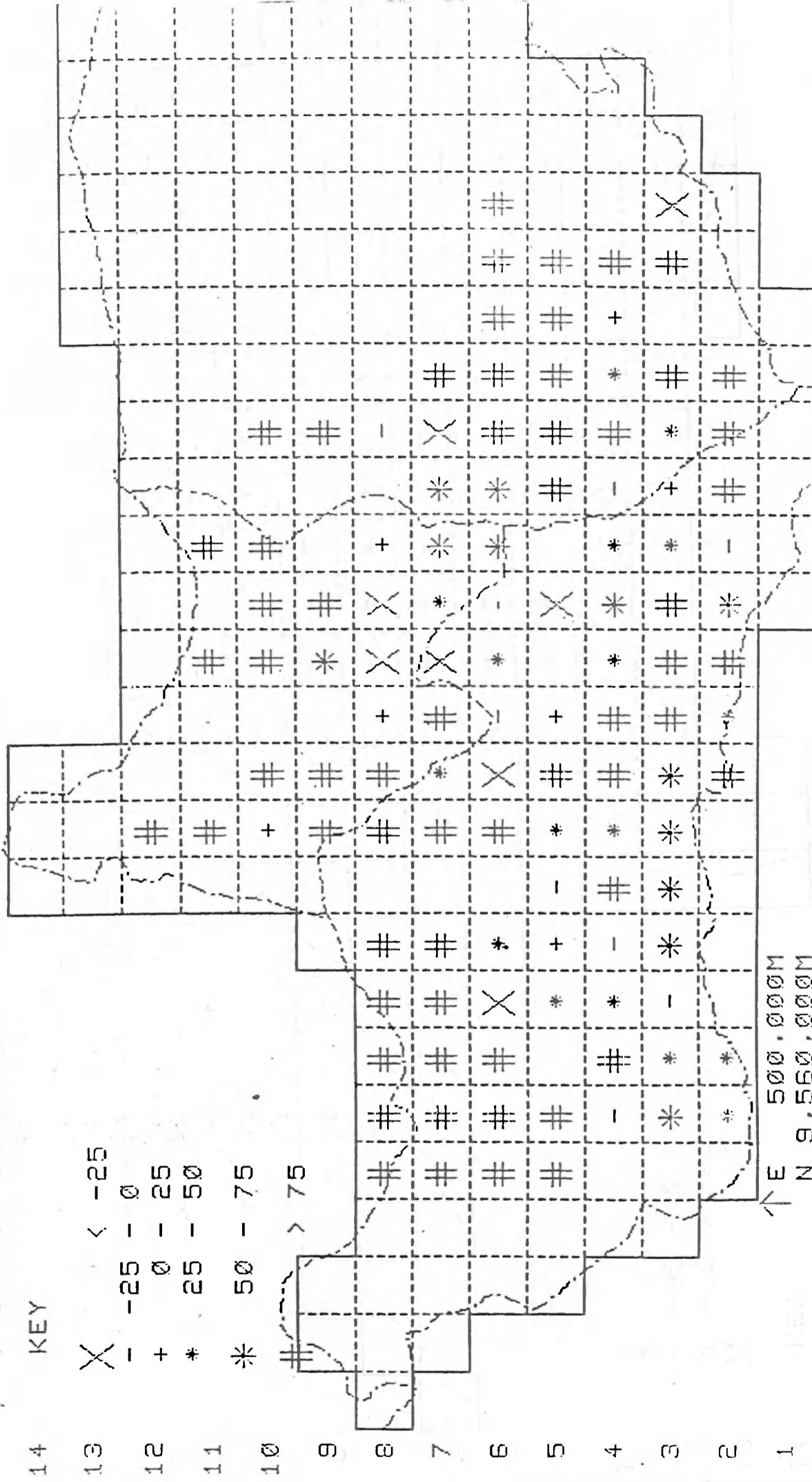

1 2 3 4 5 6 7 8 9 10 11 12 13 14 15 16 17 18 19 20 21 22 23 24 25
 E 500,000M
 N 9,560,000M
 FIGURE 5: RELATIVE CHANGE IN AGRICULTURE INDEX, 1964 - 1976

SOUTH-EAST SHINYANGA REGIONAL SURVEY NOVEMBER 1981

% CHANGE IN INDEX

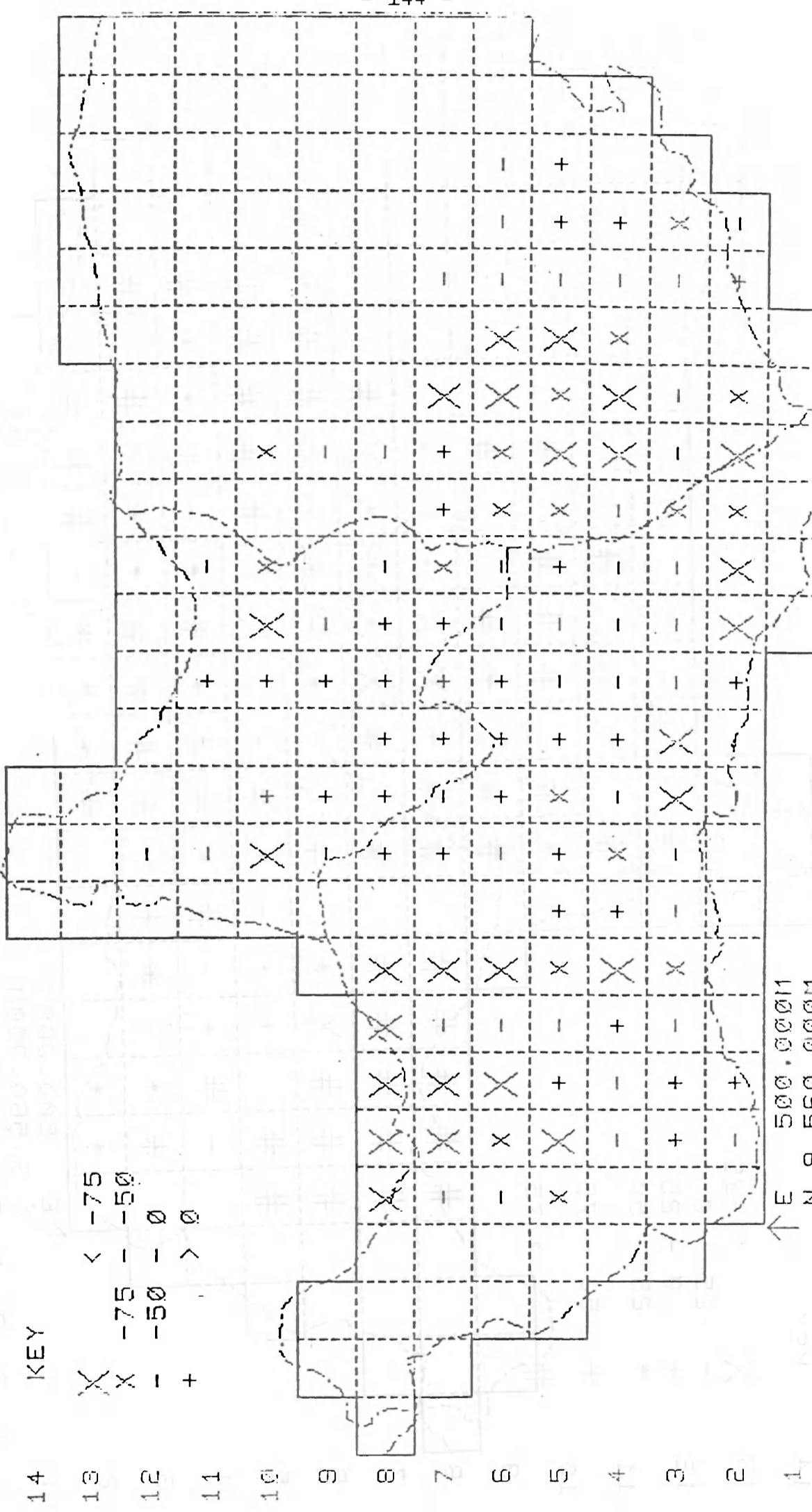

↑ E 500,000M
N 9,550,000M

1 2 3 4 5 6 7 8 9 10 11 12 13 14 15 16 17 18 19 20 21 22 23 24 25
 FIGURE 6: RELATIVE CHANGE IN WOODED AREA INDEX, 1964 - 1976

SOUTH-EAST SHINYANGA REGIONAL SURVEY NOVEMBER 1981

INDEX LEVELS

| | | | | |
|----|-----|---------|----------|--|
| 14 | KEY | | | |
| 13 | . | < 10 | LOW | |
| 12 | * | 10 - 30 | MODERATE | |
| 11 | * | > 30 | HIGH | |
| 10 | | | | |
| 9 | | | | |
| 8 | | | | |
| 7 | | | | |
| 6 | | | | |
| 5 | | | | |
| 4 | | | | |
| 3 | | | | |
| 2 | | | | |
| 1 | | | | |

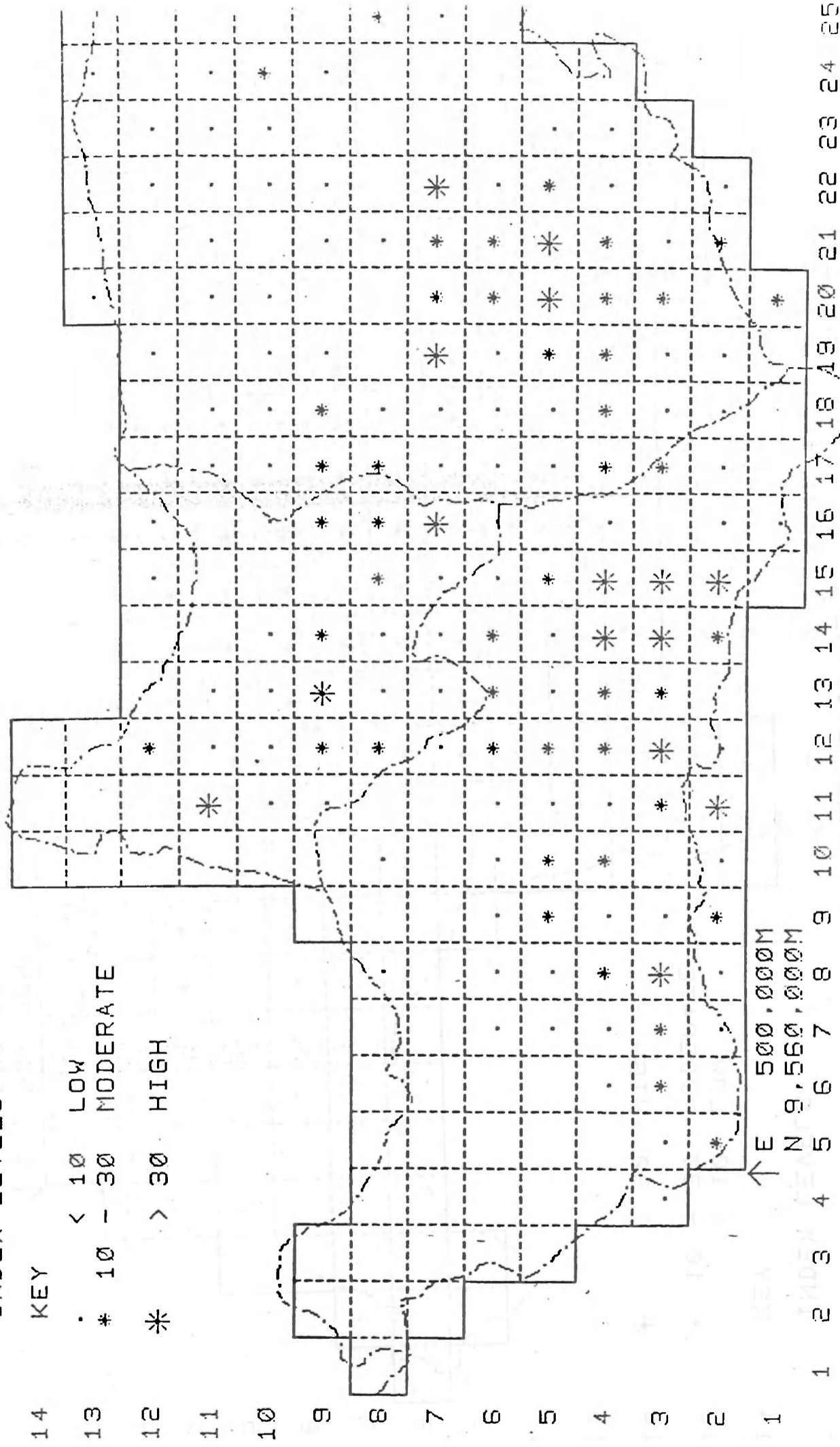
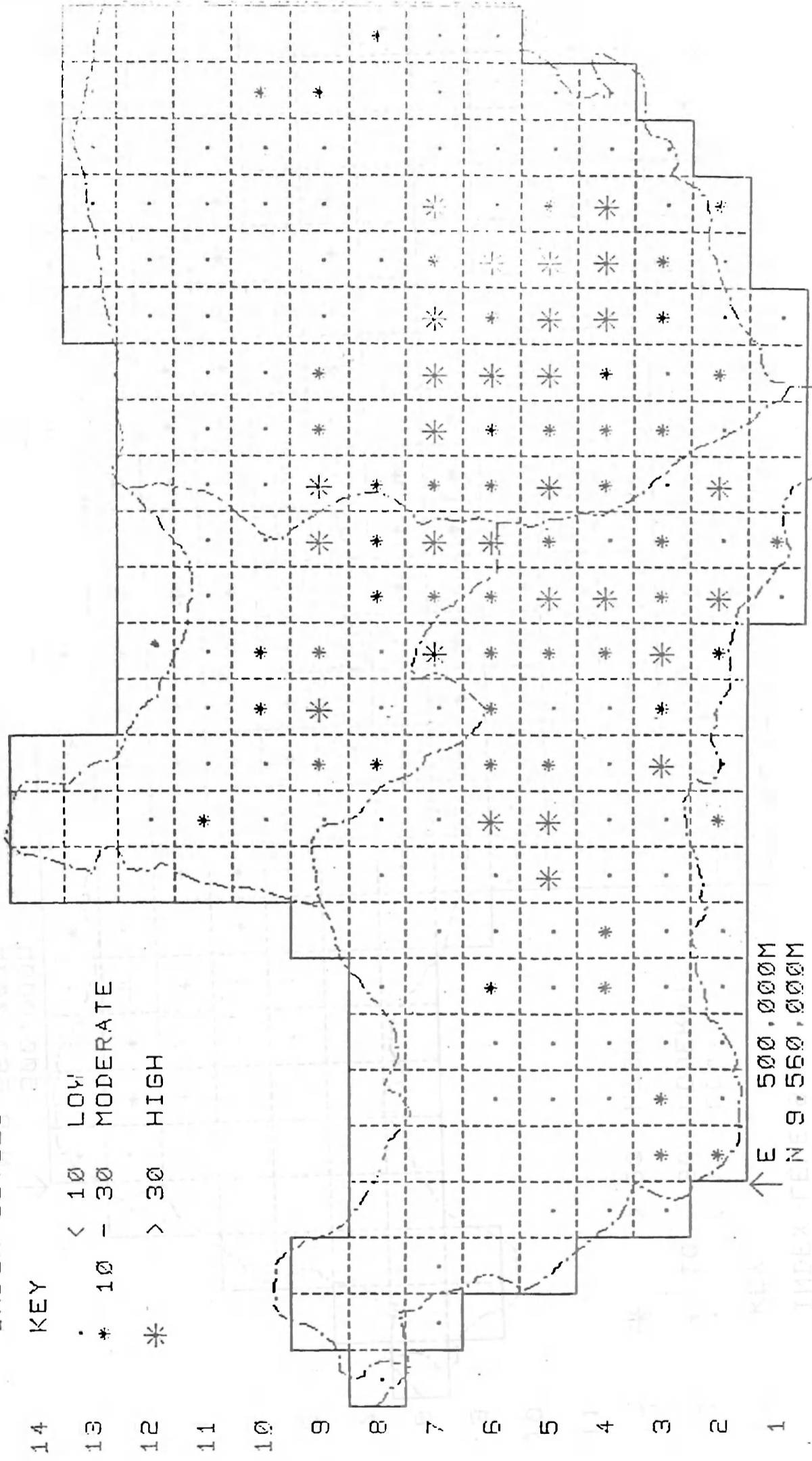

FIGURE 7: GULLY EROSION INDEX

SOUTH-EAST SHINYANGA REGIONAL SURVEY NOVEMBER 1981

INDEX LEVELS

- 14 KEY
- 13 . < 10 LOW
- 12 * 10 - 30 MODERATE
- 11 * > 30 HIGH



↑ E 500,000M
INDEX FEN 9,550,000M

1 2 3 4 5 6 7 8 9 10 11 12 13 14 15 16 17 18 19 20 21 22 23 24 25
FIGURE 8: SHEETWASH EROSION INDEX

SOUTH-EAST SHINYANGA REGIONAL SURVEY NOVEMBER 1981

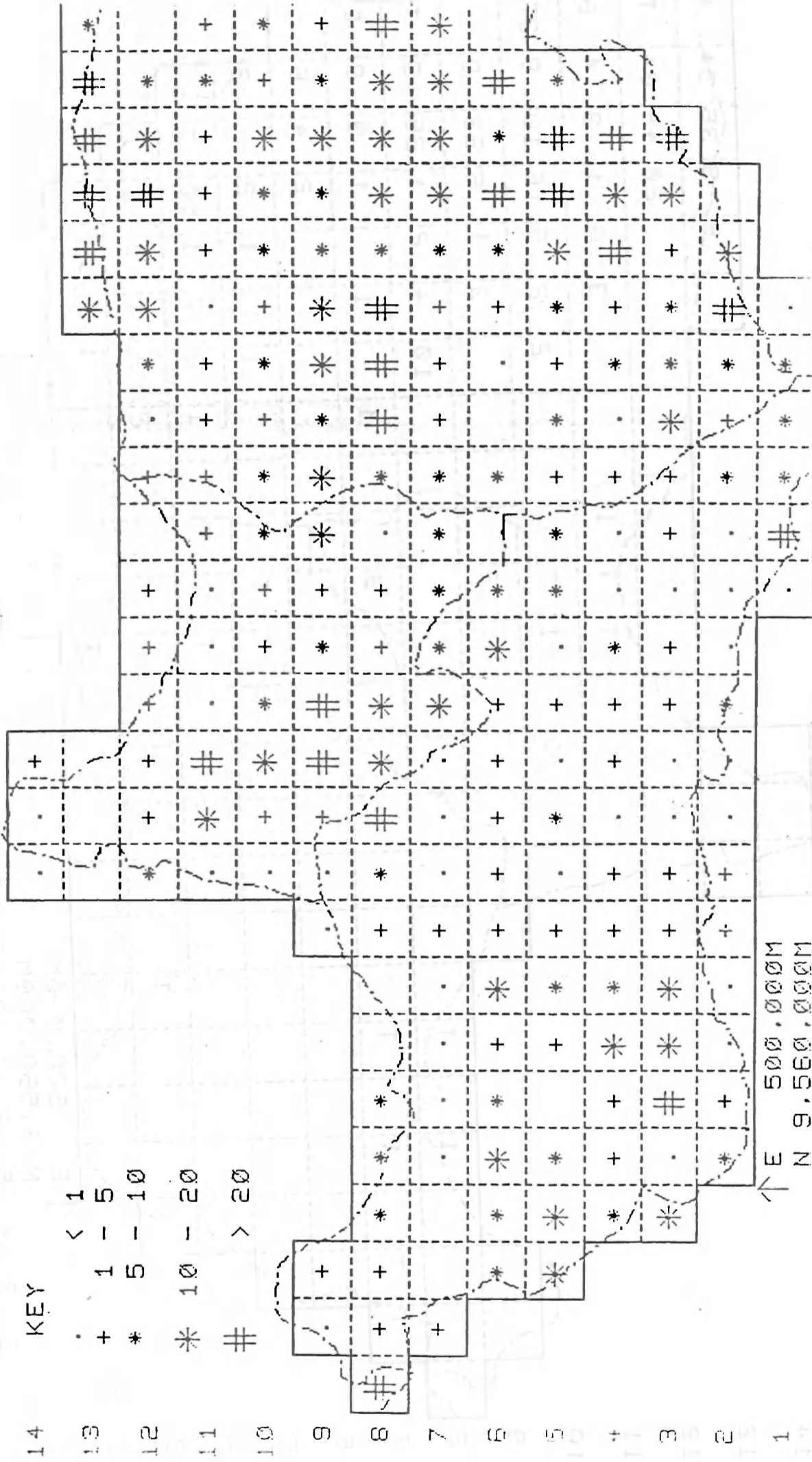

FIGURE 10: TOTAL LIVESTOCK UNITS - KMT2

SOUTH-EAST SHINYANGA REGIONAL SURVEY NOVEMBER 1981

WOODY CANOPY AREA, HA/KM²

| KEY | < 1 |
|-----|---------|
| . | 1 - 5 |
| + | 5 - 10 |
| * | 10 - 20 |
| 米 | > 20 |
| # | |



1 2 3 4 5 6 7 8 9 10 11 12 13 14 15 16 17 18 19 20 21 22 23 24 25

FIGURE 11: AREA OF WOODY CANOPY

SOUTH-EAST SHINYANGA REGIONAL SURVEY NOVEMBER 1981

SOUTH-EAST SHINYANGA REGIONAL SURVEY NOVEMBER 1981

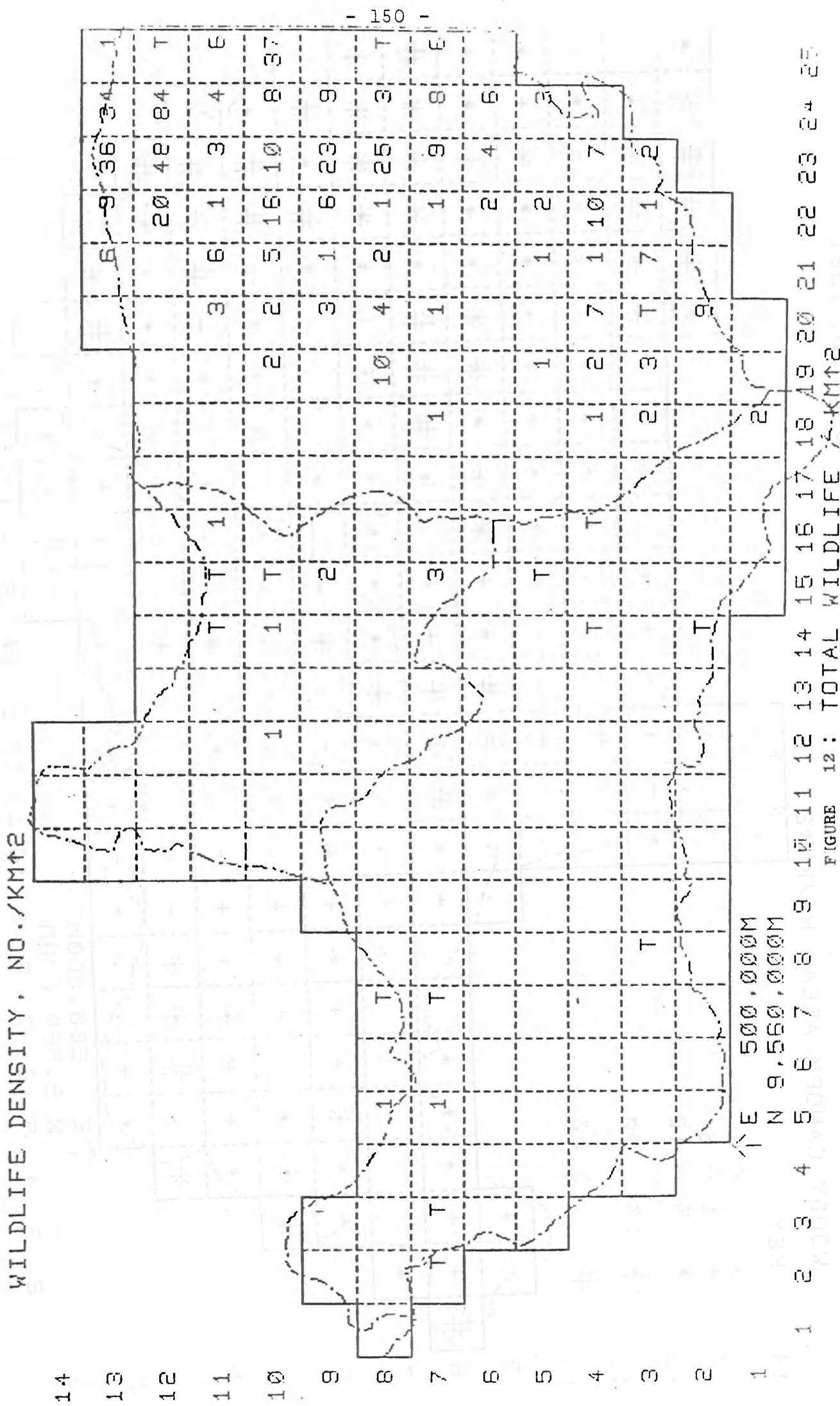

LANDSAT DATA FOR RESOURCE ANALYSIS

By

Barry N. Haack
Regional Remote Sensing Facility
Nairobi.

INTRODUCTION

A major problem for many decision makers and resource scientists is the lack of current reliable information on which to base decisions or conduct scientific investigations. This is particularly true for the extent and location as well as changes in such natural resources as forests, rangeland, agricultural fields, soil types, and water features. A very useful data source in providing such information, especially in a regional context, is the Landsat orbiting satellites. These satellites have been repetitively collecting images of essentially the entire earth's surface since 1972. The purpose of this paper is to describe the Landsat satellite system, the data collected by this system, some applications of this data to soil and water resources, and the availability of this data and services provided by the Regional Remote Sensing Facility in Nairobi.

LANDSAT

The Landsat satellites are part of the rapidly growing techniques of remote sensing. Remote sensing is the collection of information without direct contact, by use of such instruments as cameras, radar systems, acoustic sensors, seismographs, magnetometers and sonar. A narrower but more conventional definition of remote sensing is the practice of data collection without direct contact between the sensor and subject area in ultraviolet to radio regions of the electromagnetic spectrum thus neglecting acoustic, seismic, and some other sensors. Remote sensing has an extensive history in aerial photo-interpretation, a data source still extremely important in current remote sensing techniques.

Remote sensing techniques have changed greatly in the past twenty years with (1) the use of new sensors such as thermal infrared and radar; (2) the use of new platforms, particularly satellites, to collect data; and (3) the use of computers to

analyse the data. The Landsat satellites incorporate all of these techniques. The first Landsat was launched by the United States National Aeronautics and Space Administration (NASA) in July 1972. Its purpose was to demonstrate the value of continuous, worldwide data gathering from an orbital platform. Landsat 1, with an expected lifespan of one year, functioned until January, 1978. Landsat 2 was launched in January 1975 and Landsat 3 was put into orbit in March 1978. To maintain continuity of data all three of these satellites have carried essentially the same instrumentation. The fourth satellite in this series, Landsat D, is expected to be launched in 1982. Landsat D will have some different sensors than its predecessors.

The satellites in the Landsat series orbit the earth at an altitude of approximately 930 km. From this altitude the satellites view a swath of the earth's surface 185 km wide. Each day the satellite makes 14 orbits of the earth, and on the 18th day the orbit pattern repeats. Therefore, every 18 days, Landsat views the entire earth's surface between 81°N and 81°S. The systems on board the satellites do not penetrate clouds. Most places are cloud free on two or more occasions each year and since the launch of the first Landsat satellite the whole of the Eastern African region has been viewed by the satellite on at least two cloud-free occasions. The overall average of cloud-free images per area is six.

There are two sensor systems on board, a return beam vidicon (RBV) system, which is basically a television sensor collecting essentially black and white images with a 40m resolution, and a multispectral scanner (MSS) which records differences in sun reflectance from earth surface features. The RBV system functioned only briefly on Landsat 1 and 2; however, it is being more thoroughly utilized in Landsat 3. The images gathered by the satellite MSS are made up of individual measurements of reflected energy for 0.4 hectare areas of the earth's surface.

These measurements are gathered row by row in a scanning system and transmitted to earth where they are received at ground stations, recorded and then reassembled to make 'pictures' of the earth's surface. A standard Landsat image views approximately 35,000 sq km of the surface of the earth. The measurements collected to make these images are taken in four parts of the electromagnetic spectrum and are measurements of green-yellow light (referred to as band 4), orange-red light (band 5) invisible infra-red energy (band 6), and a further step in infra-red energy (band 7). Precise definition of these bands is as follows:

| | | |
|--------|-----------|-----------------------|
| Band 4 | 500 - 600 | nanometers wavelength |
| Band 5 | 600 - 700 | nanometers wavelength |
| Band 6 | 700 - 800 | nanometers wavelength |
| Band 7 | 800 -1100 | nanometers wavelength |

The images are generally available as prints or transparencies in several sizes but most frequently obtained as 18.5 cm by 18.5 cm products at a scale of 1:1,000,000. Portions of these images can generally be enlarged to a scale of 1:100,000. The images may be obtained in black and white for the RBV data or individual MSS bands. Individual MSS bands can be projected through color filters and registered to produce false color composites (FCC's). The FCC's can be obtained in several band and color filter combinations but most typically produce an image very similar to one obtained by use of color infrared film where vegetation appears red.

The procedures for visual examination of Landsat images are almost identical to those used for interpreting conventional aerial photographs. Landsat's much smaller scale, making objects appear smaller than on aerial photos, is the principal difference. As with aerial photo interpretation the materials needed can range from nothing more than a pencil and transparent paper to expensive, sophisticated optical instruments.

Landsat is not intended to be a substitute for aerial photography and its inability to provide the same type of information as aerial photography should not be cited as a deficiency. This system was primarily intended to provide thematic maps at scales of 1:100,000 or 1:250,000 (Morley, 1977). The spatial extent and frequency of coverage provide advantages of Landsat data over that obtained from aerial photography. The data from these satellites is often complimentary to that from aerial photography and the combination of these data types in multistage sampling is often very effective in resource analysis tasks.

There are several Landsat data characteristics which make it a valuable tool for resource inventory and analysis.

Some of these important characteristics are the following:

1. Worldwide Coverage. There is existing Landsat data for essentially all habitable land surfaces and in some areas of the world this is the only reasonably current or accurate data available.
2. Repetitive Coverage. Repetitive data is important for the analysis of features only observable at specific times such as seasonal fluctuations in lake or reservoir water levels. Multitemporal data is also important to monitor crop growth and other dynamic features.
3. Synoptic View. The extensive area covered by one Landsat scene provides an examination of large features or regional patterns difficult if not impossible by other means.
4. Uniformity Over Time. Each system satellite passes over a given latitude on the earth's surface at approximately the same local time. This uniformity of sun illumination eases data interpretation.
5. Uniformity Over Large Areas. Mosaics of national, subcontinental, or even continental areas can be created using Landsat images.
6. Multispectral. Data are acquired simultaneously in four bands through the same optical system. Some features can be better observed on individual bands or specific combinations of bands.

Burned grasslands or forests can be best seen on MSS Band 7 while turbid water or shallow water features can be best seen on MSS Band 4.

7. Planimetric. Landsat's high altitude and the narrow of land scanned produces near orthographic images. This means that shapes, dimensions, and relative locations of individual features remain almost constant over the entire image.

8. Readily Available. There are no restrictions on the availability of the Landsat data. For East Africa all Landsat images with less than 30 per cent cloud cover are available to examine or purchase at the Regional Remote Sensing Facility in Nairobi.

9. Easily Usable. A great amount of information can be obtained from Landsat data by persons with limited training and without extensive equipment. Many of the basic techniques of aerial photography interpretation can be applied to the imagery. More sophisticated equipment and extensive training can enhance the utility of this data source but are not always required.

10. Inexpensive. The cost of purchasing Landsat images is extremely minimal on a cost per unit area basis. Current, 1982, costs for a 18.5 cm by 18.5 cm color print covering 34,000 square kilometers is 180 Kshs.

The Landsat system has many useful attributes for national or regional resource assessments. There are many situations where this is a very appropriate data source and others where it is not appropriate. Landsat data, as most remotely sensed data, is most useful when combined with other information such as topographic, soils, or geologic maps.

HYDROLOGY APPLICATIONS

In the Eastern Africa region Landsat data provide an important source of information about water resources. The repetitive coverage of Landsat is ideally suited to provide seasonal images of surface waters from which changes in the

areal extent, presence of vegetation, and degree of turbidity may be correlated with contemporary or previous field studies of actual conditions. Data derived from the analyses of such images can provide a rational basis for planning the economic utilization (salt or water extraction and agriculture) and engineering development (roads and airfields) of these hydrologic features.

Simple location of surface water can be done very effectively with Landsat. Surface areas greater than five hectares can be identified with 99 per cent accuracy. Mapping of floods and water courses or water body changes for map updates can also be done very effectively.

Repetitive coverage of Landsat may determine if a stream is in continuous or intermittent flow. Landsat has proved effective in providing data on stream networks for drainage maps in Lesotho.

It has provided reconnaissance-level data needed for the development and operation of large irrigation projects as in Swaziland. Such data may also be used for the design of major impoundment structures and their impact can be Landsat monitored. Landsat data have in some situations provided input to water-demand or ground-water-flow models for irrigation projects.

Landsat data are used to assess major watershed characteristics that affect runoff. It may be possible in the semi-arid and arid watersheds of East Africa to develop information on runoff prediction based on data from Landsat and available meteorological satellites (Haack and Falconer 1981).

Interpretation of a photographic print of Landsat data also reveals features associated with ground-water occurrence such as landforms and landform patterns, drainage characteristics, vegetation types and associations, outcrop patterns, soil tones, lake patterns, and landuse or landcover characteristics. Some detected features directly imply the presence of shallow sands

and gravels; other features indicate rock types or the presence of folds and fractures. There is often a good correlation between lineaments detected on aerial photographs or satellite images and the occurrence of ground water in dense, fractured limestones. There is good reason to believe that many lineaments are related to ground-water occurrence in other types of dense, fractured rocks. Another application of Landsat can be the delineation of zones of potential recharge for ground-water supplies. Delineation of such recharge zones could aid in more efficient management of water quantity and quality (Moore, 1978).

In one area of the Sahel, no surface drainage ways of any substance were found on Landsat, indicating very poor soils for that region. The absence of surface drainage ways may suggest the presence of shallow aquifers which could be developed for livestock watering points for nomadic herds (Macleod, 1973). The regional distribution of existing watering points may also be associated with regional patterns of geology revealed by the Landsat data. Thus for the development of regional hydrology plans Landsat data can play a useful role, as in Tanzania where satellite data have been used by the Bureau of Resource Assessment and Land Use Planning (BRALUP) in compiling data for regional planning purposes (Haack and Falconer 1981).

PEDOLOGY APPLICATIONS

Aerial photography has been an important tool to the soil scientist to plan and operate field activities as well as to delineate soil boundaries. The Landsat data attribute of importance to the soil scientist include 1) availability for some areas where no other data exists, 2) synoptic coverage to identify regional soil patterns, 3) repetitive coverage to provide data under wet or dry soil conditions and when vegetation cover is minimal, and 4) multispectral capabilities because different spectral regions have different functions in soil analysis. Perhaps the greatest utility of Landsat data for the soil conservationist is not the direct examination of soils but the examination of the coverage and condition of vegetation communities which are often indicators of soil differences.

The usefulness of reflectance data from surface features as provided by Landsat for soil mapping is limited because conventional soil series are differentiated by both surface and subsurface properties. Landsat cannot discriminate between soils which are differentiated only by subsurface features. The ability to delineate soil characteristics from this data is a function of the correlation between the spectral properties and important physical or chemical properties of the soils. Soil color is obviously important in soil reflectance, but variations in soil moisture, surface roughness, crusting, or cultural practices also affect reflectance. This data can frequently identify variations in organic content, salinity, and soil moisture. An ability to identify soil moisture will most likely improve by use of a thermal MSS band. The interference of surface vegetation in directly examining soils is often a problem. In some cases this problem can be minimized by use of temporal data when the vegetation interference is minimal. In other situations, the relationship between soil and vegetation is such that an identification of vegetation types or densities is an indicator of soil type. Satellite data is seldom sufficient to identify the same spatial and functional detail as traditional soil mapping but may be very effective in determining broad soil characteristics and soil patterns over wide areas in a short time particularly for reconnaissance surveys. In areas of severe soil erosion creating greater exposure of the subsoil causes a changing of the spectral reflectance which can be seen on Landsat data (Davis, 1975).

REGIONAL REMOTE SENSING FACILITY

Because of the value of remote sensing in natural resources studies and the need for such studies in Africa, the Regional Center for Services in Surveying and Mapping included a remote sensing division in its plans. The Regional Centre, set up under the auspices of the U.N. Economic Commission for Africa, is designed to provide specialized services in surveying and mapping under the motto 'mapping for development'. The United States Agency for International Development (USAID) entered into an agreement with the Regional Centre, which provides support for the remote sensing division.

The Regional Remote Sensing Facility is the remote sensing division of the Mapping Centre. It provides advice, services and support for users in the Eastern Africa. The Facility produces copies of satellite images from an extensive library of photographic transparencies and can create scaled enlargements, map overlays and photographically enhanced images to meet user requirements. There are charges based on a cost-recovery policy for the photographic products. The Facility also provides a programme of subsidized training courses in remote sensing and a subsidized consultant service for investigators wishing to utilize remote sensing data. Work is also done on a co-operative basis with natural resources projects in the region.

SUMMARY

Improved natural resource utilization without excessive environmental damage is a priority task for many managers and decision makers. Good management decisions concerning resource utilization necessitate accurate and current information on the location, quantity, and condition of the resources-information not available to many decision makers. The United States Landsat series of satellites for the collection of natural resource data can often provide information needed by decision makers and natural resource scientists.

The Landsat data is available for essentially all habitable land areas of the earth, collected very frequently, readily available, easily utilized, and inexpensive. It has been demonstrated to be applicable to many resource areas. Landsat cannot be useful in all situations and has limitations but individuals involved in the acquisition of resource information should be aware of the existence and possible utilization of this data source. In East Africa Landsat imagery, training, and technical advice is available from the Regional Remote Sensing Facility in Nairobi.

REFERENCES

- Davis, S.M. ed. 1975. Mapping Soil Characteristics, FOCUS series, Purdue University Laboratory for the Application of remote Sensing, West Lafayette, Indiana, U.S.A.
- Haack, B.N., and Falconer, A. 1981. Remote Sensing of Natural Resources in Eastern Africa - Water Resources, Remote Sensing Facility Publication, Nairobi, Kenya.
- Macleod, N.H. 1973. 'Applications of Remote Sensing to Resource Management and Development in Sahelian Africa,' Symposium on Significant Results Obtained from Earth Resources Technology Satellite, National Aeronautic and Space Administration, Washington, D.C., pp. 1475-1481.
- Moore, G.K. 1978. 'The Role of Remote Sensing in Groundwater Exploration,' Proceedings of Joint Indo-U.S. Workshop on Remote Sensing of Water Resources, Hyderabad, India pp. 22-40.
- Morley, Z.W. 1977. 'Remote Sensing as a Source of Data for Development,' Nossin, J.J. (ed.) Surveys for Development, Elsevier Scientific Publishing Company, Amsterdam, pp. 79-89.

A CASE STUDY OF THE APPLICATION OF
LANDSAT DATA FOR SOIL AND VEGETATION
ANALYSIS IN THE RIFT VALLEY WEST OF NAIROBI

By

Luka Atonya Isavwa
Regional Remote Sensing Facility Nairobi

INTRODUCTION

Background Information

(a) Study Area

The Study area is located in the Rift Valley west of Nairobi mostly along Nairobi-Magadi road which starts near Bomasa of Kenya on Langata Road.

The Rift Valley has been faulted giving rise to steep escarpments up to 1000 metres high. Due to the faulting together with volcanic activities, many varied landforms have been produced. These landforms have various soils including shallow stony reddish soils with frequent surface stones, boulders or rock outcrops. Also due to volcanic activity, ash derived soils of little to moderate profile development have resulted on moderately to gently sloping landforms. These soils mainly support dwarf vegetation.

A number of closed lakes have evolved due to the volcanic activity. Lake Magadi is a good example. It is suggested that many of the lakes were extensive in the past and many of the plains have brown calcareous clays or loam or black cracking clay soils derived from lacustrine deposits (Scott, et al, 1971). The differences in rainfall between Nairobi and Magadi is reflected in the differences in vegetation. Nairobi has an annual rainfall of 907mm (35.7 inches) whereas Magadi has an average of 370mm (14.6 inches). Nairobi has an elevation of 1661 metres above sea level and Magadi is 604 metres above sea level.

Due to a high evaporation loss, Lake Magadi is primarily a thick crust of soda ash at the surface and a highly concentrated solution of sodium sesquicarbonate (trona) below this.

(b) Remotely Sensed Data

Recent developments of high altitude photography and the use of multispectral sensors to identify natural formations are being introduced in the developing world. New mapping and monitoring infrastructure have hence to be created by developing countries in line with the introduction of this space technology in surveying.

Remotely sensed data can be used qualitatively by visual interpretation or by computers to assist in surveys of soils and vegetation cover. Thematic maps which are produced using Multispectral Scanner (MSS) data in addition to aerial photographs can provide data on managing rangelands, estimating carrying capacity of the land, developing environmental indicators as well as evaluating environmental impacts.

Landsat imagery exist in black and white as well as colour composites. In this study colour composites enlarged to a scale of 1:250,000 have been used. The satellite image of Nairobi region which also extends up to Lake Magadi provides a view of the Rift Valley with its major faults and volcanic features as well as indications of the diversified soils and vegetation cover.

METHODOLOGY

The main method used was the visual interpretation of False Colour Composite (FCC) and other imageries. Colour and tone were employed, supplemented with field checks.

The image interpretation is mainly qualitative which is satisfactory provided field work is added. Consistent colour and tone will give a precise indication that the soil (which is a stable matter) is the same or it is the one which has given the changes. Likewise vegetation or other cover will modify the

the colour and tone of the soil. The combination of soil and vegetation analysis appears to be linked due to the influences that each feature renders to the other.

Classification of soil types has been attempted based on land systems which were described by Scott et al (1971). However, classification of land use from imagery will remain a personal task for an indefinite period of time (Odenyo and Pettry 1977).

Land resources express themselves on colour imagery in different colours and tones indicating the amount of electromagnetic radiation (EMR) reflected from the earth surfacial materials. This also depends on the spectral distribution and intensity of incident energy, the angle of incidence of incoming radiation, the orientation of the topography, the roughness of the topography and the absorptive characteristics of the materials. Understanding the reflection of the electromagnetic energy is a prerequisite in classification of the natural resources. Recognition of tonal and textural differences comes with experience (Blair-Rains 1971).

RESULTS AND DISCUSSIONS

Results

The results of the classification of soils and vegetation analysis are given in Table 1. Recognition has been given to the landsystem described for Western Kenya (Scott et al, 1971). The land system approach has been used as a base for classifying the soils and vegetation in addition to image colour.

The present sensor's resolution is adequate only for identification of broad categories of soil and vegetation types. Table 2 is an attempt to use reflectance to classify the soils and vegetation. What is shown in the table is the colour of the images identified followed in the second column by suggested objects that give these colours and the third column suggests the

reflections that are involved. It is suggested that different image dates would give a more complete understanding.

The use of aerial photographs or other forms of remote sensing techniques does not relieve the investigator of the need for fieldwork. The fieldwork revealed a lot of variations which made the present classification possible.

Discussions and Applications

Volcanic Hills

Most of the hills in this area are volcanic in nature and include Ol Esayeti, Ol Esakut, an old volcanic complex, as well as Olorgesailie.

The hills are complex enough as to have many valleys, infilled basins and valley floors. All these different variations give different colours and tones on the Landsat imagery.

The soils on the ridges are shallow reddish brown clay loams which are generally less than 30 cm deep and overlie lava rock. The valley floors have dark reddish brown friable loams to clay loams up to 5m deep. Surface stones are frequent so that from a distance the tops of the hills appear dark grey. Most of the hills described are in the Esakut land system reflecting a lot of variations.

The ridges and valleys support different vegetation types. Mostly they have little herbaceous cover and the rest of the area is nearly covered by rock. Those hills on the eastern side after Olorgesailie have more herbaceous growth than those west of the Olorgesailie hills. Acacia tortilis is found in the valley floors while Sporobolus spp is found on the slopes of these hills. Sansevieria spp is also present amongst the stones. Image colour is a mixture of red for trees, yellowish blue for grass which is dry and whitish patches for exposed soil and rock and plains.

Fault Scarps

The numerous fault scarps are represented by north-south black signatures on the imagery. This is due to the fact that during the time the sensor was over the area, the western side of the scarp was in shadow while the eastern side was illuminated.

The surfaces of the fault scarps are covered by large numerous stones of volcanic origin. The soil is generally shallow mixed with sand and gravel. The colour is generally brown supporting stunted vegetation. The common species are those of the Acacia genus such as Acacia mellifera and A. brevispica which, together with Boscia angustifolia, make up the large percentage of the tree and shrub cover. The grasses are mainly drought resistant such as Sporobolus spp as well as needle grass (Aristida kenuiensis) with very thin leaves to minimize evapotranspiration. The illuminated sides of the fault scarp show a mixture of red, blue and yellow tones.

Foot Slopes

These slopes are characterised by very shallow stony reddish brown loams or sandy loam, with frequent surface stones and lava outcrop, whose depth is variable up to 50 cm. In some places the dark reddish brown fine sandy loams are found with a depth of about 75cm.

The dominant trees are Acacia xanthophloea and A. tortilis. Shorter trees and shrubs such as A. mellifera, Boscia sp. Grewia bicolor and G. villosa are also present. Herbaceous cover is sparse. Sporobolus spp and Aristida kenuiensis are found. The image colour is complex including red, blue, yellow and black tones.

Plains

The plains in this area are suggested to be old lake beds the evidence of which are calcareous soils as well as diatomaceous earths. Oltepesi trading area is situated on one

such lake. The other one is Lake Olorgesailie on the shores of which was the famous settlement of early man discovered and described by Dr. Leakey. The Losinyai plain is extensive east of River Ewaso Ngiro while Ewaso Ngiro is on the west of the river.

The Esonorca, Ongata ol Kulul and Oltepesi appear pale bluish with red tints. During the dry season the colour changes to bluish yellow. This is due to the strong weak reflection of infra red (I-R) wavelength.

Olorgesailie prehistoric site area shows white due to the fact that there is strong radiation from all the bands. The same happens to Losinyai and Ol Kematian plains. When the soil is dry it can assist in the reflection of all the wavelengths since the herbaceous layer is sparse.

Lake Magadi

Lake Magadi appears to be at such a low point that groundwater table reaches the surface. The groundwater is so highly charged with sodium sesquicarbonate that in the hot dry atmosphere of Magadi the lake water evaporates leaving a thick crust of soda ash at the surface and a highly concentrated solution of sodium sesquicarbonate (trona) below this.

The image colour for the lake is white due to the strong reflection in all wavelengths. There are some patches which are black due to change in water content.

CONCLUSION

A False Color Composite displays many different colours and tones which can be used for the analysis of soils and vegetation cover. On the basis of 10 different colours and tones a description of soil types and vegetation can be done since there is a strong relationship between them.

Table 1. Results

It can be concluded that deep red indicate green living forests while pink represents grass usually short and some scattered shrubs. White is the color of those features and objects which reflect strongly in all bands. Other colour combinations are due to the heterogeneity of the landscape and materials which are present.

Thematic maps for inventory and development can be drawn from Landsat data. It is recommended that more multidata analysis be undertaken to add to the foregoing description.

| Color | Description | Vegetation / Land Use |
|---------------|---------------|-------------------------------|
| Dark grey | Dark grey | Open grassland, low shrubs |
| Black | Black | Water bodies |
| Light grey | Light grey | Open grassland, low shrubs |
| White | White | Highly reflective surfaces |
| Dark red | Dark red | Green living forests |
| Pink | Pink | Short grass, scattered shrubs |
| Yellow | Yellow | Open grassland, low shrubs |
| Light green | Light green | Open grassland, low shrubs |
| Dark green | Dark green | Open grassland, low shrubs |
| Light blue | Light blue | Open grassland, low shrubs |
| Dark blue | Dark blue | Open grassland, low shrubs |
| Light purple | Light purple | Open grassland, low shrubs |
| Dark purple | Dark purple | Open grassland, low shrubs |
| Light brown | Light brown | Open grassland, low shrubs |
| Dark brown | Dark brown | Open grassland, low shrubs |
| Light orange | Light orange | Open grassland, low shrubs |
| Dark orange | Dark orange | Open grassland, low shrubs |
| Light yellow | Light yellow | Open grassland, low shrubs |
| Dark yellow | Dark yellow | Open grassland, low shrubs |
| Light cyan | Light cyan | Open grassland, low shrubs |
| Dark cyan | Dark cyan | Open grassland, low shrubs |
| Light magenta | Light magenta | Open grassland, low shrubs |
| Dark magenta | Dark magenta | Open grassland, low shrubs |

Table 1. Results

| Land System | Soil type | Vegetation cover | Image colour |
|-------------|---|--|-------------------------------|
| Karen | Dark reddish brown friable clays to clay loam | Highland forest Found on edge of Nairobi National Park and extending towards Karen and Ngong Trees: <u>Croton megalocarpus</u> , <u>Eucalyptus</u> spp, <u>Grevillea</u> spp. <u>Acacia drepanolobium</u> Shrubs: <u>Rhus natalensis</u> , <u>Euclea</u> spp, <u>Solanum incanum</u> Grass: <u>Themeda triandra</u> , <u>Pennisetum mezianum</u> Forbs: <u>Leonotis</u> , <u>Vernonia</u> spp, <u>Aspilia mossambicensis</u> | Dark red to red |
| Embakasi | Dark grey black crackling clays (Black cotton soils) | Open grassland Area has grasslands with scattered <u>Acacia drepanolobium</u> . <u>Balanites aegyptiaca</u> and <u>Croton</u> spp. The common grasses are <u>Themeda</u> , <u>triandra</u> , <u>Pennisetum mezianum</u> , <u>Setaria phleoides</u> , <u>Ischaemum</u> sp. and <u>Hyparrhenia</u> spp. | Pink |
| | Shallow, yellowish red friable | Riverine forest mainly <u>Acacia xanthophloea</u> lining river channels. Others <u>Acacia tortilis</u> , <u>Croton</u> sp. | Dark red |
| Ngong | Dark brown sandy clay loam over yellow red to reddish brown sandy clay loams. | Highland forest Main trees are as described for Karen. Grassland also occurs on the mountain. | red to pink |
| Hannington | Dark reddish brown sandy clay loam. | Bushland: Mainly bushy shrubs of the <u>Acacia</u> genus on shallow soils. Trees and shrubs: <u>Acacia tortilis</u> , <u>A. brevispica</u> , <u>A. mellifera</u> , <u>A. gerrardii</u> Grass: <u>Pennisetum mezianum</u> , <u>Cynodon plectoctachyum</u> Forbs: <u>Sansevieria</u> , <u>Leonotis</u> spp. | Red/black/blue/Yellow mottles |

| | | |
|--|---|-------------------------------|
| Greyish yellowish brown clay loam | <p><u>Bushed grassland:</u> Mainly <u>Acacia nubica</u> which is leafless. Other trees include <u>Boscia angustifolia</u>.</p> <p>Grass: <u>Sporobolus</u> spp covers less than 1%. Bare ground covers about 80%.</p> | Greyish-Yellow |
| Yellowish greyish soils | <p><u>Bushed grassland.</u> The vegetation surrounds the Greyish-Yellow Lake (L. Magadi). Common species are those of the <u>Acacia</u> genus. Grass: Mostly absent. Bareground: covers more than 90%.</p> | |
| Black cotton soils | <p><u>Bushed grassland</u> The most dominant bush is <u>Acacia drepanolobium</u> (whistling thorn) common on black cotton soils. The other bushes are <u>Rhus natalensis</u>, <u>Solanum incanum</u> <u>Maytenus</u> spp. Grass: <u>Themeda triandra</u>, <u>Setaria phleoides</u>, <u>Sporobolus</u> spp. <u>Pennisetum mezianum</u> Forbs: <u>Aspilia mossambicensis</u> <u>Heliotropium</u> spp.</p> | Blackish blue |
| Reddish dark brown clay loam with surface stones. | <p><u>Bushed grassland.</u> Trees: <u>Acacia tortilis</u>, <u>Acacia gerardii</u> <u>Tarconathus camphoratus</u> (Leleshwa), <u>Albizia</u> spp. <u>Combretum</u> spp. Cover about 1% . Shrubs: <u>Grewia</u> sp. <u>Acacia drepanolobium</u> <u>A. mellifera</u>, <u>Solanum incanum</u> cover about 1% Grass: <u>Themeda triandra</u>, <u>Hyparrhenia</u> spp., <u>Sporobolus</u> spp., <u>Aristida keniensis</u> covers about 20%. Forbs: <u>Leonotis</u>, Bare ground and rock 70%.</p> | Red/Blue/Black yellow mottles |
| Yellowish brown clay loams covered by stones and gravel. | <p><u>Bushed (grassland).</u> The vegetation is made up of <u>Acacia mellifera</u>, <u>A. tortilis</u>, <u>A. nilotica</u>, <u>Boscia angustifolia</u>. Grass: Almost none Bareground: covered by rock mainly of volcanic origin and brownish in colour.</p> | White |

| Land System | Soil type | Vegetation cover | Image colour |
|-------------|---|---|-----------------------------|
| | Yellowish brown clay loams | <p><u>Bushland:</u> <u>Trees:</u> <u>Acacia tortilis</u>, <u>A. mellifera</u> however they cover less than 5%.</p> <p><u>Grass:</u> Some grass inc. <u>Sporobolus sp.</u> In some cases dry.</p> <p>The ground is covered by stones of volcanic origin</p> | Pale bluish green |
| Losinyai | Dark yellowish grey to dark brown silty loam. | <p><u>Forest</u> This is found at base of the Nguruman escarpment.</p> <p><u>Trees:</u> <u>Acacia tortilis</u>, <u>Ficus sycomoris</u>, <u>Boscia angustifolia</u>, <u>Tamarindus indica</u>.</p> <p><u>Shrubs:</u> Profusion of forest undergrowth but the most prominent are the following: <u>Acacia nilotica</u>, <u>A. seyal</u>, <u>Cordia spp.</u> <u>Solanum incanum</u>, <u>Harrisonia sp.</u> <u>Hibiscus flavifolius</u>.</p> <p><u>Grass:</u> <u>Pennisetum clandestinum</u>, <u>Giant Sporobolus</u>, <u>Eragrostis tenuifolia</u>, <u>Hyparrhenia spp.</u>, <u>Themeda triandra</u>.</p> <p><u>Forbs:</u> <u>Aspilia mossambicensis</u>, <u>Sansiviera Vernonia sp.</u>, <u>Glycine sp.</u> Settlements and food crops found also.</p> | Deep red to red |
| | Dark reddish brown to greyish yellowish brown clay loams. | <p><u>Open grassland</u> <u>Trees:</u> cover less than 3% made up of <u>Acacia tortilis</u> <u>Boscia angustifolia</u> <u>Balanites aegyptiaca</u></p> <p><u>Shrubs:</u> <u>A. mellifera</u>, <u>Aerva spp.</u>, <u>Sericocomopsis hilderbrandtii</u></p> <p><u>Grass:</u> <u>Pennisetun mezi- anum</u>, <u>Aristida keniensis</u>, <u>Seteria phleoides</u>, <u>Ischaemum afrum</u>. Most of the grass is dry.</p> | Pale bluish with red tints. |

| Land System | Soil Type | Vegetation cover | Image Colour |
|-------------|--|--|------------------------------------|
| | Diatomite yellowish brown clay loam. (Diatomaceous earths) | <u>Open grassland</u> Plant species as the foregoing Fossil landscape with the above named plants. Others are <u>Pennisetum coloratum</u> . Shrublike <u>Grewia</u> is found. | White |
| Losinyai | Light greyish yellowish clay loam. | <u>Open (grassland)</u> Very little cover with scattered tree and shrub cover. Surface is full of volcanic rocks. Trees that are present are very sparse. <u>Acacia tortilis</u> is common. <u>Grasses</u> such as <u>Pennisetum mezianum</u> and <u>Sporobolus</u> spp are found but widely separated on the ground. | White |
| Esakut | Shallow reddish brown clay loam | <u>Shrubland or Bushed grassland.</u> Mainly on hilly terrain and the vegetation is a mixture. Trees: <u>Acacia xanthophloea</u> , <u>A. tortilis</u> , Shrubs: <u>A. mellifera</u> , <u>A. nilotica</u> , <u>Tarchonanthus camphoratus</u> . Grass: <u>Pennisetum mezianum</u> , <u>Cenchrus ciliaris</u> , | Red/blue/black and yellow tones |
| | Black cotton soil | <u>Open Grassland</u> Plains area surrounded by volcanic hills. Most of the soil is transported to this area. Trees: <u>Acacia xanthophloea</u> <u>A. tortilis</u> . Grass: <u>Pennisetum mezianum</u> , <u>Ischaemum afrum</u> . | Yellowish green or greenish yellow |

Table 2. Reflectance

| <u>Image colour</u> | <u>Object</u> | <u>Observation</u> |
|----------------------------------|--|--|
| Deep red | Indigenous close forest usually on hills. | Very strong I-R and fairly strong green reflectance but poor |
| Deep red - red | Dense vegetation and broad leaf trees. | reflectance of red wavelength which is absorbed in photosynthesis. |
| Pink | Sparse grass, tea, swamps. | I-R reflectance strong. |
| Greenish-Yellow Greyish-green | Bare red soil. Dry grass and trees. | I-R reflectance less strong than reflectance in visible light bands of spectrum. |
| Pale blue | Buildings and some lake surfaces. | |
| Pale bluish green | Dry grass leaf, sparse vegetation | |
| Pale bluish with red tints. | Dry grass, some trees on plain | |
| White | Exposed carbonate on surface of lake. Exposed carbonaceous soil light toned rock. | Strong reflectance in all bands. |
| Red/Blue/Black/ Yellow | Mixed | Reflection mixed. |
| Black | Shadows on ridges, clear water bodies. | Less or no reflection. |

Dry grass and leafless trees may appear pale bluish green or greyish green and this is due to increased reflectance of red light.

Also when light passes through the leafless canopy of trees and bushes like Acacia nubica to the ground it is absorbed and reflected differently.

REFERENCES

- Blair-Rains, A. (1971). The Evaluation of African Rangeland using Aerial Photographs, Land Resources Division, Directorate of Overseas Surveys, Surbiton England.
- Pratt, D.G., Greenway, P.J. and Gwynne, M.D., (1966). A Classification of East African Rangelands with Appendix on terminology. J. appl. Ecology 3: 369 - 382.
- Norton-Griffiths, M. 1981. Grass fires in Serengeti National Park, Tanzania. Remote Sensing Facility, Nairobi.
- Odenyo, V.A.O. and Pettry, D.E. (1977). Land Use mapping by Machine Processing of Landsat-1 Data. Photogrammetric Engineering and Remote Sensing 43, 515-523.
- Orr, D.G. (Undated). Image forming process. Lecture notes, Eros Data Centre Sioux Falls, South Dakota.
- Taranik, J.V. and Trantwein, C.M. (1976) Integration of Geological Remote Sensing techniques in subsurface analysis. U.S. Geological Survey open file Report No. 76 - 402 Sioux Falls, South Dakota.
- Taranik, J.V. (1978). Characteristics of the Landsat multi-spectral data system. U.S. Geological Survey, Report No. 78 - 187 Sioux Falls, South Dakota.
- Williams, D.L. and Stanffer, M.L. (1979). What can the Forestry community expect from Landsat-D Thematic Mapper Data. In the Proceedings of the Symposium on 'Remote Sensing of Natural Resources'. University of Idaho, Moscow, Idaho, Sept. 10-14, 1979.
- Scott, R.N.; Webster, R., and Lawrence, C.J., (1971). A Land system Atlas of Western Kenya.
- Falconer, A. and Isavwa, L.A. Nairobi - Magadi Field trip Kenya Museum Society Sunday 19th July, 1981. Unpublished, Remote Sensing Facility, Nairobi.

SOIL AND WATER CONSERVATION EXTENSION:
THE KENYA EXPERIENCE

By

S.N.J Njoroge
Soil Conservation Extension Unit, Ministry of
Agriculture, Nairobi.

A. PREAMBLE

Resource conservation is an important aspect of nationhood. This aspect was realised in Kenya and the Kenyan Government charged the Ministry of Agriculture through its Land Resources Development Division with the task of carrying out the functions of Soil and Water Conservation in the country. In the Land Resources Development Division there is the Soil and Water Conservation Branch whose entire staff are involved in National Soil and Water Conservation activities. Also in the same division, there is an Agricultural Mechanization Branch which oversees the activities of mechanized aspect of soil and water conservation through its machinery services section. The two branches in the division aim at serving the farmer to achieve his objective of conserving both the soil and water on his farm.

B. POLICY.

Soil Conservation is carried out through two methods namely:

- a) Labour Intensive Approach
- b) Mechanized method.

The labour intensive approach involves carrying out soil conservation on steep slopes where mechanization would not be possible due to the steepness of the land. Here, human labour is utilized completely hence the name Labour Intensive Approach.

On land where the slope allows the use of machinery and the farmers can afford to pay the Government subsidized rates, then heavy machines are used to carry out soil and water conservation activities. These activities involve

terracing, levelling, water hole and dam construction, and drainage works. The essential services in soil and water conservation are subsidized while the non-essential services are not subsidized. These aspects of essential and non-essential services will be discussed later in the paper.

C. LABOUR INTENSIVE APPROACH IN SOIL AND WATER CONSERVATION

1. The Policy

The policy of the labour intensive approach to soil and water conservation is to tackle the problems of soil and water conservation especially in steep land where mechanization is not possible. The human labour is employed to lay and construct cut-off drains i.e. diversion ditches that prevent water from an upper catchment from destroying farm land in the lower slope. The Government pays for both layout and construction of the cut-off drains which protect more than one farm per cut-off drain from water caused erosion. Also artificial waterways are laid and constructed at Government subsidy as in the case of cut-off drains. The artificial waterways are constructed where the cut-off drains cannot empty into a natural waterway, grassland, or stony drain.

Laying of terraces, grass strips and trash lines is also a subsidized aspect. The farmers are expected to construct the terraces once the agricultural staff have laid out the terraces. Similarly as in the case of terraces, the farmers are expected to plant grass strips and lay trash lines as pegged out by the agricultural extension staff. No Government subsidy is involved in terrace construction, planting and laying out of grass strips and trash lines respectively.

2. High Medium Potential Areas

In most high potential areas, the main problem is the high population pressure resulting into fragmentation of farm holdings and spilling over of the excess population into the medium or marginal lands for cultivation. This

pressure results in misuse of available land in both the high and medium potential areas. In the high potential areas, the farmers have cultivated their farms in areas even where slopes exceed 80%. According to the Agricultural Act Cap. 318, no cultivation of land is permissible on slopes exceeding 35%. But these farmers cultivating slopes exceeding 80% have no other pieces of land to cultivate. What should the agricultural extension staff do to such farmers? Should such farmers be stopped from cultivating their only piece of land? Or should the staff devise soil conservation measures that can allow the farmer to cultivate his piece of land without causing soil erosion? These are some of the dilemmas the extension staff face during their daily work in the high potential areas with high population like Kisii or Central Province. In some of these high potential areas, some farmers are practising strip cropping on slopes up to 80%. They start with a woodlot at the top of the hill followed by the homestead and a pasture. Below the pasture is the food crop plot with a strip of bananas and/or sugarcane and another woodlot followed by valley bottom cultivation with sugar canes, vegetables, arrowroots, etc. In such situations, erosion is not serious. But, where strip cropping is not practised, then the acute problem of soil erosion is serious and demands full attention.

The medium or marginal area into which the excess population spills from the high potential area has the problem of land abuse through inappropriate cultivation and indiscriminate grazing. The problem here is the paradox of too little water and too much water at different times of the year. When rains come, these areas have more water than they need and the problem is water conservation. These rains come with heavy downpour when the land is bare due to either land preparation or overgrazing. Ministry of Agriculture staff are involved in advising the farmers to carry out contour ploughing and terrace construction to facilitate water retention on the ground and to allow infiltration of water into the ground as much as possible. This will

increase the water available to the crop. On grazing land, the ideal situation of proper stocking rate is still a major problem as most farmers still want to have a big number of livestock on their farms. This has, and is, still causing the biggest problem of soil erosion in marginal areas of our country.

Water harvesting is another large part of water conservation in marginal lands for both cultivation and tree planting. More of this aspect will be covered by one of my colleagues in the Ministry currently working in Baringo Semi-Arid Areas Pilot Project.

3. Components Involved in the Labour Intensive Approach to Soil and Water Conservation

There are four major components involved in the labour intensive approach to soil and water conservation. These are training, routine soil conservation, gully control and rehabilitation of eroded land and agroforestry nursery development.

These are discussed below.

3.1 Training

The Soil and Water Conservation Branch carries out training of the extension staff of the Ministry of Agriculture and other departments within the Government who are involved in soil conservation extension apart from the Ministry itself. The training is carried out as follows:

a) Senior officers

These are Agricultural Officers and Assistant Agricultural Officers. A one week seminar is held at Kenya Institute of Administration (KIA) Kabete for the senior officers with one day's excursion usually to Machakos District. The Seminar involves coverage of

both the theory of soil conservation and practical training in handling of instruments used in soil and water conservation. These instruments include line level, clinometer, quick set level and pocket stereoscope. The participants use the instruments during the practical training and similar instruments are provided to the field officers for their use in soil conservation.

b) Technical Assistants

The Technical Assistants are the graduates of the Agricultural Institutes who obtain a Certificate in Agriculture after two years training. These officers are trained for two and a half weeks in the theory of soil conservation together with practical training in use of line level, quick set, clinometer and pocket stereoscope in carrying out soil conservation works like terracing, cut-off drain laying and also laying of grass strips and trash lines. Also during the same period, an excursion within the district of training is taken to let the participants see for themselves the practical aspects of soil conservation successes and failures in the field.

c) Provincial Administration Staff

The Provincial Administration staff involved in the training are the District Officers, Chiefs and Assistant Chiefs. These cadres of staff are trained at different times and their training involves the policy issues and their role in soil conservation activities in the field. The duration of training is 3-days with one full day devoted to an excursion in the field to discuss the successes and failures of soil conservation due to various reasons. During the training period, the Provincial Administration staff are instructed about their role in causing either the failure or success of soil and water conservation in their respective positions in the civil service.

d) Local Leaders

This category covers teachers, church elders, councillors and KANU officials. These people have a seminar for two days with one day devoted to a field excursion. One day, similarly to the Provincial Administration course, is devoted to policy issues and their respective role in enhancing soil conservation activities in their local areas. The excursion may be done within their district or outside their district.

e) Farmers

The farmers, though listed last, are the most important element in the training programme. In the field, several field days are held at the local level when the farmers are invited to discuss soil conservation aspects.

In our Farmer Training Centres (FTCs), farmers are taught aspects of soil conservation irrespective of the course attended. Two slide collections are available to show the farmers aspects of good and bad farm management resulting in good and bad land use respectively.

Apart from these types of training which are part of soil conservation extension, the Ministry of Agriculture also sponsors students to the University of Nairobi for post graduate training in soil conservation and Egerton College for soil and water engineering. The Institutes of Agriculture namely Bukura, Embu, and Eldoret are producing graduates with soil and water conservation background who are absorbed into the Ministry of Agriculture extension service.

3.2 Routine Soil Conservation

Routine soil conservation involves laying out of terraces, grass strips, trash lines and construction of both the cut-off drains and artificial waterways. As

outlined in the policy point above, the Government only subsidizes laying out of terraces, grass strips and trash lines but does not pay for their construction, planting, or maintenance. The laying and construction of cut-off drains and artificial waterways are paid for by the Government. The farmers are expected to carry out conservation measures in the plots below the cut-off drains by constructing terraces and/or grass strips and trash lines. The Agricultural staff have at present little problem in carrying out routine soil conservation measures in the field. The only problem noticed in the field is improper design of artificial waterways, especially on very steep slopes where these waterways sometimes result in gullies.

3.3 Gully control and Rehabilitation of Eroded/Overgrazed land

Gully control is one of the areas where little practical experience is available in African conditions. In Kenya, little information is available on methods successfully applied in gully control. With this problem of lack of successful techniques, the Ministry of Agriculture, through the Soil and Water Conservation Branch started gully control measures at a cautious speed. The aim was to give the extension staff. (a) a training ground and (b) an experimental position in which various methods of gully control have been tried and have shown their failures and successes. Gully control has been done using vegetative strips (grass, sisal, euphorbia, etc.), wooden check dams, loose rock check dams, gabion check dams and a combination of two or all of the three types of check dams. In cases where the design has been done correctly and maintenance has followed, especially after heavy rains before the gully has stabilized, successful results have been obtained. However, this exercise has not been without failure, especially where wrong designs of check dams, incomplete work, and poor maintenance after heavy rains have been persistent. But all in all, some experience has been gained by the extension staff who are at present controlling especially small size gullies with little problems.

Rehabilitation of eroded/overgrazed land is done as a demonstration to the farmers to show them that with proper land management, overgrazing can be stopped and more can be obtained from the same piece of land even with the animals present but at a controlled stocking rate. The demonstrations have been done in two ways.

- a) Closing an area from grazing and allowing the natural vegetation to regenerate without any assistance.
- b) Closing an area from grazing, reseeding it with grasses and planting of trees and sometimes ploughing at 1-3 m. intervals to allow water to infiltrate quickly into the soil.

Results have shown that an area under treatment (a) takes a longer period than treatment (b) before it can be economically utilized by the farmers. These demonstrations have given good results and farmers are taking these demonstrations into practise in their farms.

3.4 Agro-Forestry: Nursery Development

Agro-forestry has been incorporated into soil conservation. In the Ministry extension service there are 53 nurseries operated by the Ministry to give the farmers both fruit tree and forest tree seedlings. The fruit seedlings are sold to the farmer at a price of k.shs. 5 while forest seedlings are given free to the farmers.

Fruit tree seedlings are mostly the citrus spp., avocado and bananas (though not a tree). Forest tree seedlings are mostly Grevillea robusta, Cuppressus lusitanica, Pinus spp., Cassia siamea, Acacia spp especially Acacia albida, Leucaena spp., Prosopis juliflora and many local trees which are suitable to various local situations.

Nursery development has some problems, namely:-

- (a) Water for seedlings. Sometimes, despite the nearness to a water source, nurseries cannot get water due to lack of pumping facilities.
- (b) Seeds: The availability of some seeds is poor, especially of forest tree seeds. The shortages have resulted in importation of seed which sometimes, lack viability.

The two problems are being looked into seriously and currently the Ministry is seeking ways and means of having pumping facilities where needed. On seed viability, more stress is now being emphasized on collection of local seeds which have known viability and are less expensive to collect and raise than the imported seeds.

D. MECHANIZED SOIL AND WATER CONSERVATION ACTIVITIES

Mechanized Soil Conservation activities are carried out on slopes where the heavy machinery can work with the limitations being the slope of the land and funds a farmer has for the work. The soil conservation work is classified into two main categories:

- a) Essential soil conservation work.
- b) Non-essential soil conservation work.

The essential soil and water conservation work involves the following:

- i) Terracing work of all types.
- ii) Farm planning, layout, and subsequent construction.
- iii) Drainage work including any reclamation
- iv) Water conservation which includes dams and water hole construction.
- v) Fire break survey, layout and construction.
- vi) All works for land utilization which are conservational in nature.

The non-essential activities are:

- i) Bush clearing
- ii) Destumping including ripping
- iii) Land levelling.
- iv) Trees and ant-hills bull dozing.
- v) Road surveys, layout, and construction.

All essential services carry a Government subsidy while non-essential services do not.

The mechanized soil and water conservation services are supervised by the Agricultural Mechanization Branch within the Land Resources Development Division. At present there are 16 Agricultural Mechanization stations spread out in the country which assist in carrying out mechanized activities of soil and water conservation. The stations are namely Nakuru, Eldoret, Kitale, Kipkelion, Ruiru, Mariakani, (old stations) Machanga, Ciakariga, Marigat, Narok, Migori, Bumala, Garsen, and Garissa (new stations).

E. COOPERATION WITH OTHER GOVERNMENT DEPARTMENTS

The Ministry of Agriculture is cooperating with other Government Departments in carrying out soil and water conservation: the Ministry of Livestock Development, especially in rangeland; the Department of Prisons in raising both the fruit and forest tree seedlings for the farmers in their respective prisons in the country; the Department of Forestry in seed procurement and technical assistance during the training of our nursery assistants; and the Ministry of Energy in woodlot development centres where the Ministry of Agriculture will give all the assistance needed to get the project off the ground.

The Permanent Presidential Commission on Soil Conservation and Afforestation has of late become another Government organ to cooperate in solving the problems of soil erosion.

Last but not least, the Ministry of Culture and Social Services and the Provincial Administration have given the Ministry of Agriculture all the support it needs in carrying out soil and water conservation activities in the field and through the Ministry of Information and Broadcasting getting many messages through the radio and T.V. on the needs and measures required to achieve the desired goals in soil and water conservation.

However, we have had problems with the Ministry of Transport and Communication, especially where new roads are constructed. At present, no soil conservation measures are taken to ensure that water from both the road and road reserves does not cause any erosion on the farm land. Water is usually diverted through culverts into farmland and no precautions are taken to ensure that the water is safely taken down the slope to the natural waterways without causing any adverse effects on the farmland.

F. CONCLUSION

Resource conservation, especially of soil and water, is of paramount importance to any nation. This calls for a concerted effort by all to see that our dear mother soil does not get into the rivers and end up in oceans and lakes to be used no more by our future generations in Kenya. The Government through the Ministry of Agriculture has emphasized the need of this resource conservation and the Ministry of Agriculture extension service is out to achieve this. It is hoped that the University of Nairobi and other institutions of learning will keep the extension service informed of their findings in soil and water conservation for dissemination to the field for the farmers' benefit.

THE ROLE OF THE PERMANENT PRESIDENTIAL
COMMISSION ON SOIL CONSERVATION AND
AFFORESTATION IN PROMOTING SOIL
AND WATER CONSERVATION

By

George K. Mburathi,

I INTRODUCTION

There could not be a better time for a seminar like this to take place in Kenya. Soil erosion everywhere in Kenya has reached a critical and worrying proportion. Hunger for water, particularly in Arid and Semi-Arid areas in Kenya has also reached a worrying situation.

The agents for soil erosion are obvious to all the participants in a workshop like this. They include, inter-alia, overgrazing, deforestation, indiscriminate destruction of catchment areas, etc. However, they all point to land use practices being incompatible with proper conservation measures or practices.

The situation in Kenya, as all of us know, has been exacerbated by:

- 1) Population pressure,
- 2) Scarcity of good fertile farming land,
- 3) Socio-political and socio-economic problems in certain areas of Kenya resulting in immobility of population.
- 4) At times non-systematic and irrational land use practices.

II GOVERNMENT AND NON-GOVERNMENTAL EFFECTS TO CONQUER SOIL EROSION

The problems of soil erosion and any related solutions are very much multifaceted and multidisciplinary. In addition there are strong linkages between soil and water conservation and land use management practices. Hence a large number of Ministries and Institutions and Non-Governmental Organisations have been involved in activities related to the overall

conservation of soil and water. They include, inter-alia:

- 1) The Ministry of Agriculture which is charged with land use and development.
- 2) The Ministry of Livestock Development which is responsible for range management and development.
- 3) Ministry of Water Development which is charged with the responsibility of promoting water catchment and water quality control.
- 4) The Ministry of Environment and Natural Resources which oversees forest and forest development.
- 5) The Provincial Administration which is involved in enforcing certain Acts.
- 6) The Ministry of Energy which is involved in promoting wood fuel conservation.
- 7) The Ministry of Transport and Communications whose responsibilities is to construct roads.
- 8) University of Nairobi which is engaged in research related to soil and water conservation and forestry and other training institutions like Egerton College.
- 9) Ministry of Tourism and Wildlife which controls Wildlife population.

III THE CHALLENGE

Despite all of these efforts, the problem does not seem to be getting less. Instead it has been getting worse and worse. It is therefore imperative that a workshop like this should pay more attention to why this has been the case.

Many of the participants have done a lot of research on soil and water conservation. At least, one could say that most of the methods of controlling erosion have been well documented, and indeed, tested and found to be practical. The biggest challenge to all of us now, in my view, is 'How do we make these methods work in Kenya's situation'.

IV CONSTRAINTS IN THE PAST NATIONAL EFFORTS

It is difficult to pinpoint specific shortcomings comprehensively because of the complexity of the problem. However, the following few could give indicative pointers.

- A) Inadequate coordination in planning and implementation.
- B) Organization duplication and gaps in responsibilities.
- C) Insufficient manpower output and unproductive manpower development.
- D) Lack of national coordinated and farm level oriented research programmes.
- E) Financial constraints.
- F) Inadequacies in relevant legislation and enforcement.

It is my conviction that we have resources, we have the manpower, and we have the capacity to tackle most of the soil erosion related problems. What we are probably missing is a proper organizational setup, efficiency, will, and commitment to tackle the problem from all angles. We need to generate all these factors through creation of awareness of the problem right across all sections of our community in Kenya. We need to impress in everybody's mind, children and adults, that every single soul in the population has a part to play in solving this problem. It is not the concern of the Government alone. Everybody must join hands if we are to avoid the disaster our future generation may experience if the soil is carried away and the forests are depleted. It is against all this background that H.E. the President established the Permanent Presidential Commission on Soil Conservation and Afforestation, and it is now opportune that I briefly mention the terms of reference and functions of the Commission.

V PERMANENT PRESIDENTIAL COMMISSION ON SOIL CONSERVATION AND AFFORESTATION

A. BROAD TERMS OF REFERENCE

- 1) To review the present legislation on Soil Conservation, Afforestation and Flood Control, and to advise on its adequacy and effectiveness.
- 2) To advise in consultation with other relevant agencies on areas that should be declared 'Protected Catchment Areas' and to recommend on the measures to be taken to regulate the management of such protected areas.
- 3) To advise on the measures to be taken to protect water courses with a view to preventing river silting.
- 4) To submit specific recommendations at every stage after deliberating on specific items.
- 5) To continually evaluate the performance of the Government agencies charged with the responsibility of implementing soil conservation, afforestation, and flood control programmes and advise on the adequacy or otherwise of Government machinery for planning and implementation of programmes in the area.

B. FUNCTIONS OF THE COMMISSION

The Commission has the following functions:

- 1) To co-ordinate and monitor government planning efforts and projects in soil and water conservation and afforestation and to initiate the promulgation of national land use policy as a cardinal prerequisite in the implementation of such projects.
- 2) To review, evaluate, and identify gaps in performance of Government Ministries and to encourage private and voluntary efforts in carrying out conservation and afforestation programmes and projects.
- 3) To promote effective liaison between government bodies and the private sector and to encourage private and voluntary efforts in carrying out conservation and afforestation programmes and projects.

- 4) To establish criteria for the design and implementation of conservation and afforestation programmes and projects.
- 5) To co-ordinate donor efforts to provide financial and technical assistance to the nation's conservation and afforestation efforts, particularly those which the Commission identifies as high priority.
- 6) To review existing conservation and flood control legislation, identifying gaps, overlaps, enforcement and other problems, and to initiate new legislation or amendments as appropriate.
- 7) To identify farming, livestock, and other commercial activities that are incompatible with sound conservation practices and initiate corrective measures.
- 8) To initiate and to review such scientific and social research and studies as are necessary for the efficient promotion of the conservation of the nation's natural resource base and setting up research priorities.
- 9) To prepare and disseminate scientific and popular publications and to promote educational efforts that reach all levels of the population and all regions of the country particularly as regards their environment and soil conservation and afforestation needs.
- 10) To coordinate government efforts as well as voluntary efforts in liason with the District Development Committees to ensure that they give proper attention to conservation and afforestation problems and activities.
- 11) To ensure that all dams are designed, constructed, and operated in conformity with sound conservation practices.

- 12) To view the various settlement and irrigation programmes and projects to ensure that land use designs and practices follow sound conservation principles.
- 13) To promote protection of forests, particularly in important water catchment areas, and to effect forest fire control activities.
- 14) To promote the rehabilitation of all degraded forests and eroded lands, including the restoration of land ruined by mining, siltation, and flooding.

VI CONCLUSION

While the Commission will be executing its functions, it will be adopting or adjusting to any new ideas and approaches to the problem of soil erosion and deforestation. Therefore any ideas that may emanate from this seminar and similar gatherings in future are welcomed by the Commission and guaranteed of consequent evaluation and possible adoption.

In this connection it is the Commission's long term commitment to ensure effective soil conservation measures based on:

- A) The best and most up-to date technical information (small secretariat of well qualified personnel to evaluate and monitor);
- B) Co-ordination point for research and development projects in the area of soil conservation (i.e. identification of gaps, mobilization of necessary organizations and funding) to be used by the Commission in designing national priorities for soil loss control;

- C) General population mobilization for effective soil conservation methods at the individual farm level. This will involve high-level government coordination, companies and non-governmental organizations.

STRATEGIES AND CONSTRAINTS IN PLANNING OF SOIL AND
WATER MANAGEMENT PROGRAMMES ON THE CATCHMENT BASIS
IN WESTERN KENYA

By

P.A.M. Misiko
Department of Agricultural Engineering
Egerton College

Introduction:

With increasing population, more and more land is being opened up for crops and animal production, the problem of floods has become increasingly serious and that of control complex. The range of disasters is wide; from the vast and recurring catastrophic flooding like those of Ahero to the occasional floods of Nairobi city.

Although the campaign against environmental deterioration, and in particular against soil erosion as potentially the most serious threat to agricultural development is an old story; there is a new concern - the concern of survival. Every man and woman has **heard** the effects of soil erosion preached and yet tonnes and tonnes of top soil continues to disappear into the oceans and lakes year after year.

In Kenya, inspite of the bitter experience in soil depletion and inspite of advances in technology, the record of progress in effective soil and water management is still generally poor in relation to the needs of many diverse areas. The background of soil and water management is one of long neglect coupled with a general assumption of unlimited land resources. The depressing point is that despite the fact that there is a long record of waste and depletion of watershed resources, land cover, soil and moisture, awareness of the problems, and of the dangers and the necessity for soil and water conservation, has only grown slowly and no real practical advances have been made in control of erosion. Does this mean that those who are in a position to control erosion do not have means and techniques to do so? A recent survey of

Western Kenya has revealed that means and techniques are available but are not used for many reasons - mainly economic but also including inappropriate technologies which cannot be applied where their need is greatest.

Owing to the fact that agriculture is the mainstay of the economy of Kenya, it is the government's policy to encourage farming with the hope that this will lead to increased income, foreign exchange earnings, employment opportunities and improvements in standard of living especially in the rural sector. But it is through farming that much of the soil loss is being encouraged. There is therefore a fundamental dilemma, a solution to which must be found if there is to be any lasting advance in agricultural development in Kenya.

Table 1 Accomplished Measures in Soil Conservation by Districts

| | KAKAMEGA | BUSIA | BUNGOMA |
|----------------------------|----------|-------|---------|
| Cut off drains - Km | 20 | 7 | 35,715 |
| Waterways - m | * | - | 1,178 |
| Grass strips - Km | * | 0.764 | 264 |
| Stone terraces - m | * | 2000 | 625 |
| Fanya Juu Terraces - m | * | 18.6 | 39 |
| Controlled gullies numbers | * | 2 | 2 |
| Bench Terraces - Km | * | 4.672 | |
| Trash lines - m | * | - | 4,821 |

* Data still being collected by field officers.

The Present Situation and Trends on Soil and Water Management

Although there is enough evidence that there has been some progress in soil and water management in the recent years, the rate of advance still falls short of adequate in relation to soil loss in view of the expansion and intensification of land use.

Table 1 indicates that some conservation work is already being carried out. Nevertheless, it is necessary to intensify the basic research and development work, to plan cooperative programmes in land use and water conservation and to coordinate activities aimed at rehabilitation, improvement and management of the catchment areas.

In addition, the roles of various institutions from state to farm level seem to be not well defined. There is sometimes total lack of technical knowhow as to where some of the structures, such as cut off drains, are supposed to be located. At other times there may be a total lack of incentive by the farmers. Hence the farmer may look to the Ministry of Agriculture to provide all needed inputs for measures to conserve soil and water.

Could it be that there is lack of sufficient technical staff to cope with the demand or is the problem that neither the farmer nor the technical officer feel responsible for identifying needs.

The present situation is characterised by on-going conservation movements in certain parts of the country through self help groups. In all this however, there is much room for extension, improvement and co-ordination. The principles and technology of watershed improvement and management on agricultural, range, pasture, and crop lands are moving ahead. But there are serious lags in investment, in rehabilitation and improvement programmes and outlays is good management, inspite of the desirability, economic feasibility and generally excellent economic returns.

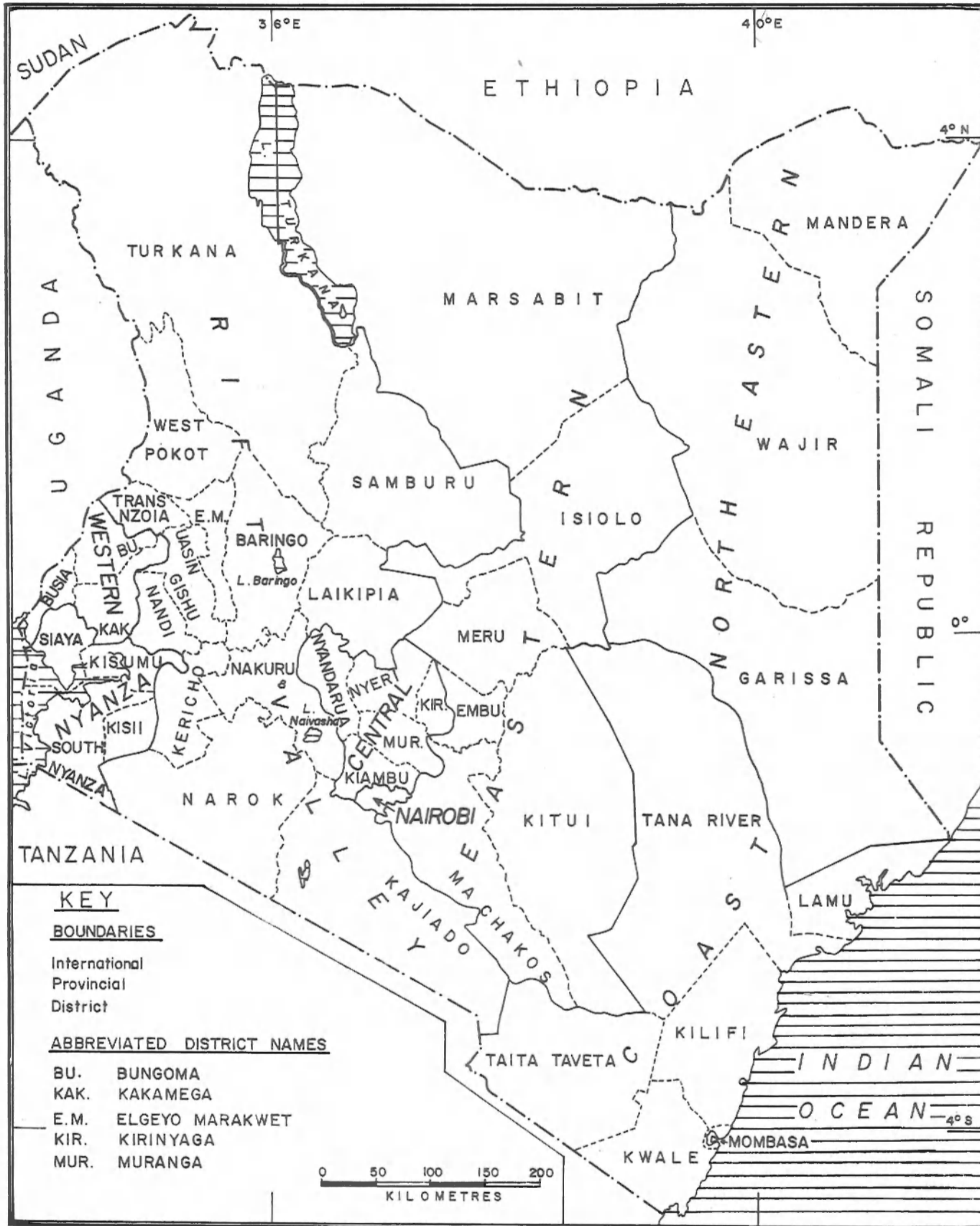

KENYA: PROVINCIAL AND DISTRICT BOUNDARIES MAP

Theoretical River Basin Considerations

In the river-basin situation, watershed lands are under various jurisdictions, viz, state, local and private. These are under various uses e.g. forest, range, agricultural, and multiple combinations.

These conditions stress, naturally the need for wide participation, co-operation and overall support for soil and water management programmes. Problem areas with severe or moderate erosion, local floods, forest encroachment or misuse of agricultural land, exist in nearly all of our river basins. The answers to these problems vary widely with consideration of soil, topography, climate, precipitation and other physical and economic factors. There is no single formula for watershed protection, type of cover or type of structural water-retarding measures.

Although the problems of soil and water management are legion, in the river basin context, the planner is concerned particularly with those requiring coordination in a comprehensive plan. These include of course, soil protection, runoff retardation and storage on the land and in the small streams, and siltation abatement. In matters of land cover, there are additional problems of water economy related to forest use, grazing management and crop production. A specialised problem in this field is that of replacement of water wasting, non-economic cover such as certain types of vegetation found in arid and semi-arid basins.

Some confusion in the public mind has resulted from frequent representation of soil and water management and small headwater works on one hand, and main stream flood control structures on the other, as alternatives. Many claims have been made by over zealous friends of soil and water management that would make the larger works completely unnecessary. However, the generalized conditions are that no more than the first few centimetres of a major flood producing precipitation will be held back in cover and soil, and that a sufficient number of small reservoirs cannot be provided to hold the remaining runoff from heavy precipitation in a drainage basin of any size. The headwater measures can, under

such conditions, only spread the discharge somewhat over time and reduce the extreme peak of flood flows in small drainage areas. However, the primary benefits of watershed treatment stand upon their own merits, and their place as complementary to a main-control, river system plan are not to be discounted. The exaggerated claims for river system planning ignore the very substantial value of soil and moisture conservation in situ and of local flow retardation, with resulting benefits in production from the soil and in mitigation of reservoir and other downstream silting. In this connection it should be added that the watershed may sometimes have only a minor effect when compared with bank and channel scouring in contributing to the total volume of alluvial materials shifted down the river to the plains.

Derived Benefits of Soil and Water Management

Soil and water management is a field in which there is often no tangible and saleable product. Public investment is generally not directly reimbursed. The purpose is to prevent wastage and to enhance national resources of soil and water. In this sense the investment is a necessary one with feasibility projects and programmes resting upon enhanced wealth and production in and from those resources.

The benefits of the programmes in soil and water conservation and increased production are both direct and indirect and are generally difficult to assess by individual land owners or local entities, although a degree of equity in cost-sharing is attained through the cooperation at local or district level. A great deal of the needed work is, however, economically beyond the private farmer on a private investment - and - return basis. This is particularly true of lands denuded of top soil which cannot be rehabilitated and operated commercially but whose protection and usage are of public interest in general. The essential general tasks of survey, research and development, demonstration and education in soil and water management are also generally beyond private and local capabilities.

Objectives, Policies and Issues in Soil and Water Management

Essentially there are two main objectives of a national programme of effective soil and water management. The first is the sustained and increased usefulness and production of the land. The second is the conservation and use of waters from the hills, the lakes and rivers. The deeper aims naturally, are those of conservation and development in general, the enhancement of human productivity and well being and the welfare of the environment. These are particularly well served by good land and water management.

The central and direct issue in carrying out such objectives is that of re-invigoration, extension, and improvement of current programmes and of their closer coordination in a purposeful and viable whole, designed, to meet the pace of growing land deterioration and expanding material need. From the national aspect a major issue is the coordination of two important parts of water control - a well - rounded watershed management plan and an overall plan for the development of the land and the water resources of the river basin.

In its pioneering view of the problems of soil and water management, the Ministry of Agriculture, Land and Farm Management Division brought out a 'Position paper on Soil Conservation' that seeks and stresses the need of public participation from agencies and private owners and operators in common efforts; recognition of government responsibility for leadership, planning, administration and liberal financial support; recognition of regional responsibilities in the organization of the obligation of private ownership to use preventive measures in erosion control with liberal public help; and coordination of policy in this field with that in other related fields.

In the first soil and water conservation workshop in 1977, the issue of erosion control was seen in very similar terms. Soil deterioration through erosion and its causes were noted as the country's most acute problem of land use. The workshop emphasised the need of protection of the land against all forms of erosion and in its very broad review of soil and water conservation progress and issues, the workshop saw desirable policies as follows:-

1. Soil and water conservation should be a principle objective in basic programmes to bring economically controllable deterioration of land under control within a reasonable time.
2. Government policies and activities - agricultural conservation, land adjudication etc, should be adjusted to strengthen the soil and water conservation.
3. In addition to providing sound technical information and advice, the need to have a National Soil and Water Conservation Committee was seen as an obvious body which could look into the problem of land reclamation in Kenya. (This has been achieved already as the Permanent Presidential Commission on Soil Conservation and afforestation.)

Planning Soil and Water Management

The discussion above indicates how soil and water management programmes should be planned. A key to an effective soil and water management programme is, in the long run, as in so many other instances, a strengthened programme of basic research and the evaluation of development in the field. A review of development and controlling practices and policies over recent years, and of the present situation in specific terms, is relevant to present day policy and plan formation.

Flood control, with conservation of water through storage in the soil and in underground and surface waters in upper reaches, should be recognized as a principal factor in soil and water management planning and development. Consistent with other aspects reservoir storage should be designed for greatest possible use and re-use of flood waters. All measures of flood protection works, flood-plain zoning, flood forecasting, release of sediment-loaded water on land, combinations of reservoirs and other works, should be considered in soil and water management planning.

The need for the inventory and reappraisal is essential, for new goals to be defined and greater progress on a broad front.

Conclusion

In summary, today's need is for a comprehensive reappraisal of existing policies, plans and programmes, and progress if Western Kenya is to forge ahead in soil and water conservation for sustained agricultural production.

On the national scene, there is a need of stepping up the pace and coverage of survey, research and development, and of extended cooperative effort in soil and water conservation work in damaged and threatened areas. In this, time limits should be set for definite stages of accomplishments in the various aspects of area organization or acquisition, rehabilitation, development and management.

In the river-basin areas generally, there is definite need for more closely tying together in complementary fashion the planning and programming for watershed and headwater area development and that for tributary and mainstream development. Both of these should be included as primary elements in a comprehensive river-basin plan.

References

- 203 -

1. Lamprey, H. (1977): 'Desertification of Northern Kenya: Some Preliminary observations'. Paper presented at the National Seminar on Desertification, held in Nairobi, 6-8 June, 1977.
2. Maher, C. (1937): 'Soil Erosion and Land Utilization in Kamba (Machakos) Reserve'. Government Printer, Nairobi.
3. Ministry of Agriculture: Land and Farm Management Division (1978) 'Position Paper on Soil Conservation' in Soil and Water Conservation in Kenya, Occasional Paper no 27 Institute for Development Studies University of Nairobi
4. Ministry of Agriculture: Land and Farm Management Division 'Amendment of the Agriculture Act (CAP. 318) section 48 (1) of the Laws of Kenya'.
5. Misiko, P.A.M. (1978): 'Situation Regarding Soil and Water Management in Kenya'. Egerton College Agricultural Bulletin vol. 2 no. 2 pp. 48-53.
6. Misiko, P.A.M. (1979): 'Environmental Engineering for Rural Progress'. The Impact of Agricultural Education on Schools and Colleges on Rural Environment and Development. Proceeding of 2nd conference, Kenya Agricultural Teachers Association (KATA) Held in Mombasa 26-30 August, 1979 pp. 60-67.
7. Misiko, P.A.M. (1982): Personal Interviews with Agricultural Officers in Busia, Bungoma, Kakamega and Nandi Districts.
8. Westley, Sidney B: Publication Editor (1978), Soil and Water Conservation in Kenya. Occasional Paper No. 27, Institute of Development studies, University of Nairobi and Egerton College.

PRACTICAL FARMERS' TRAINING IN CONSERVATION TECHNIQUES:
- OBSERVATIONS AND EXPERIENCES IN MACHAKOS DISTRICT -

By

Michael A. Zobisch
Machakos Integrated Development Programme.
Machakos.

1. INTRODUCTION

Misuse and depletion of agricultural resources by farmers necessitates an increased effort to speed up the application of appropriate soil and water conservation techniques. It was observed by the author that during the last two to three years, the awareness of farmers in Machakos District of the current erosion problem and its consequences for the future has multiplied, resulting in a constantly increasing demand for professional advice and assistance from the appropriate institutions. However, governmental and non-governmental resources (financially and staff-wise) are limited and are not the only means to solve erosion problems everywhere in the country. This implies that farmers should take more responsibility and make a greater effort themselves to improve their land management.

A majority of farmers are still exclusively dependent on agricultural extension staff for advice and practical aid on very simple conservation techniques. Because of the large number of farmers in widespread operational areas (administrative locations and sub-locations) and the diverse characteristics of the extension staff's duties which cover the whole field of agriculture, this staff cannot cater for the increased demand of farmers seeking help.

These constraints define the need to enable more farmers to apply simple conservation techniques themselves through a specially designed training programme, so as to make them more independent from the locational extension staff and to relieve the latter from mass routine work.

2. THE MIDP FARMERS' TRAINING PROGRAMME

The Machakos Integrated Development Programme (MIDP) has therefore started a trial training programme for farmers which is meant to cover all aspects of soil conservation which can be carried out by them. This need made it necessary to simplify a number of techniques and to present them in a way the farmers can understand them. In order to achieve long term success, a programme like this must be continuous, and, if necessary repetitive. The following reflects methods and experiences of MIDP during its trial courses.

2.1. Training Units

The whole programme is divided into sections which serve as training units. They are:

- a. design and layout of terrace systems,
- b. improved soil tillage,
- c. set-up and management of self-help nurseries,
- d. pasture improvement (improved fodder production),
- e. rural afforestation (tree planting on farms),
- f. improvement of rural roads and footpaths,
- g. construction of simple gully structure (sediment traps, check dams, inlet structures, etc.)

Each unit represents a course on its own. The units are equally important for the farmers and experience has shown that the farmers are not yet convinced of this. They all know, that, for instance, terracing benefits them and they are ready to invest a lot of effort into this activity. But they do not yet believe that pasture improvement, rural afforestation and road maintenance are as important in the long run.

2.2. Selection of Training Units

The training programme has to start with the component (unit) in which the farmers have the greatest confidence. In our case, this is terracing techniques. Experience has shown that once farmers realize that they can successfully design and

lay out terraces for themselves and discover that they are effective they will be ready to attempt other techniques they previously had shunned due to their prior misgivings. This is the time to start with the training of such techniques.

2.3. Selection of Course Participants

Realizing the number of farmers in the District (approximately 200,000 families according to the 1979 census) and their demand for training, it is unrealistic to believe that each individual farmer could and should be trained. With more emphasis and effort being put on the development of self-help groups, there is an opportunity to build up and organize pools of trained farmers within these groups. Once the existence of farmers' training courses is known (through chiefs' barazas), there is generally great demand for participation. This is the stage to involve the groups.

Each group gets the option to select two to four members, depending on the size of the group, and to delegate them to the courses. This group selection process serves two purposes. Since all farmers organized within a group have usually known each other very well for a long time, the group is likely to select farmers who are intelligent and educated enough to follow the courses successfully and at the same time will be cooperative and ready to help the other members of the group. This process largely eliminates the possibility of selecting farmers who will be uncooperative with their neighbours or fail to share their newly acquired skills. It will also, to some extent, aid in the formation of new action; although this was rarely observed in Machakos District, an area with traditional self-help groups.

2.4. Principles of Course Implementation

Several important principles have to be observed when organizing farmers' courses of this type.

The courses must be oriented towards practical exercises, with the number of participants limited to enable the instructor to effectively teach the course. Classroom situations should be avoided as it has proven to hamper the retention of information by the farmers. They are generally unfamiliar with proper classroom-type teaching, i.e. lectures, the use of blackboards, and are uncomfortable sitting for long periods of time. This impairs their ability to concentrate.

The most convenient course size for this sort of activity was twelve participants forming three groups of four farmers each. This gave the instructor the chance to allocate sufficient time to each group and to thoroughly discuss questions and problems arising during the exercises.

The courses should be as short as possible and contain a minimum of necessary theory, enough to enable the participants to understand why certain practical steps have to be taken. For example, the course concerning terrace system design and lay out, using the line level, usually took one full day. A short presentation of information and demonstration of the instrument was introduced at the beginning of the course, field exercises practised during the remainder of the morning session and most of the afternoon session; and a complete terrace system laid out at the end of the day. This was to be constructed by the farmers later as their first project.

The course sessions should be conducted, if possible, in the local language because in many cases the farmers' knowledge of Swahili was not enough. Most of our courses were held in a mixture of Swahili and Kikamba, depending on the participants and the instructors.

The courses should be organized and conducted as locally as possible. This reduces travelling time and cost for the farmers. It was found that a distance of about eight to ten kilometres was the maximum a farmer could walk without being too exhausted to follow the course.

The participants would normally gather in the nearest village and use a field of a nearby participating farmer as the training ground.

The farmers would normally cater for themselves with food although MIDP has sometimes provided a snack available at a local restaurant or shop. But providing food was not observed to be any significance concerning the attendance of the farmers.

2.5. Post-Course Considerations

It is very important that the farmers are able to actually apply the obtained skills in the field. Therefore, at least each group, or where possible, each participant, should be given the necessary instruments or inputs. This makes them really independent in their work and avoids building up a potential of educated, but inactive farmers. This especially applies to situations where the acquisition of tools is beyond the farmer's financial limits. For terrace design, each course participant in Machakos was issued with a set of line levels. For pasture and fodder improvement, a basic supply of grass seeds and tree seedlings was given.

It is vital, for a long term success of any farmers' training programme, that a follow up on the post-course activities and performances of the participating farmers be carried out as a standard exercise by the instructor. Follow-up in the case of the terracing course was done approximately four to six weeks after the course. In this way, the instructor can insure that his courses were appropriate and enable him to correct possible errors and misunderstandings. It also provides information as to the general progress of self-help groups in conservation works. At this stage, it is important to support active self-help groups with a sufficient number of handtools. According to experience in Machakos, this greatly encourages the groups' motivation to intensify their activities.

2.6. Instructors' Qualifications

Another critical point for success of the courses is the performance of the instructor himself. Experience shows that the average locational and sublocational technical assistant and junior assistant can perform this task well after a short 'refresher session'. They are also capable of organizing the course themselves at sublocational level in conjunction with the chiefs, subchiefs, and non-governmental organizations.

Each instructor must be equipped with adequate transport facilities; with either sufficient funds to travel by bush-taxis or with a bicycle so that he can reach training groups in remote areas for course instruction and follow-up.

2.7. Visual Aids

A useful complement in farmers' courses is the provision of supporting visual aids. First of all, a specially designed handout, based mainly on clear illustrations (simple drawings and photographs), will not only aid the instructor during his explanations, but also serve as a technical reference to the farmers after the course. It has also proved to be useful to distribute additional posters or picture books which also illustrate the problem of erosion and possible solutions in more general ways. This increases awareness by the farmers and readiness to adopt conservation measures. In Machakos, adult education classes have also served to help prepare the basis for an increased demand for training in a similar way.

Because of the lack of a power supply and the complicated technology of the projection equipment, the role of slides and movie films in up-country farmers' training courses is restricted, making them unsuitable for a training programme of this nature. Use of these techniques would also increase the total cost of the programme significantly.

2.8. Farmers' Performances Observed After The Trial Courses

During the period from September, 1980, to December, 1981, a total of 287 farmers were trained, representing 7,745 group members organized in 189 self-help groups. Follow-ups conducted four to eight weeks after the courses, showed a terrace layout performance per participant ranging from 167m to 1012m, with an average of 535m. This totals up to a layout distance of 153 kilometres. Generally, the quality of the layout was satisfactory. Only very few layout lines needed to be corrected.

3. CONCLUSIONS

The courses described above showed that it is not only possible, but also feasible and successful to conduct up-country farmers' courses in practical conservation techniques. The involvement of self-help groups in the selection of the participants is a significant advantage.

Care has to be exercised during the course to balance theoretical basics with practical exercises. This provides a thorough understanding of the practical steps in the field and is achieved without loading the participants with too much unnecessary theory which might tend to confuse them. The offer to farmers of further courses covering other aspects of conservation must be timed carefully, so that the courses can be conducted as soon as the demand for them arises. Adult education classes seem to be an ideal forum to initiate and detect these needs.

ACKNOWLEDGEMENTS

Thanks are due to all officers and persons who assisted us in the implementation and subsequent follow-up of the trial courses: Michael Njoroge, Joseph Mbuthia, and Justus Kinyua from the District Agricultural Office; Gerald Oosterwijk and Paul Valentin from the Dutch Volunteer Service; and Arnold Maingi from the Diocese of Machakos.

INFORMATION FOR SOIL AND WATER CONSERVATION IN KENYA

By

Mutuku Nzioki
Librarian Egerton College

INTRODUCTION

Agriculture is the backbone of Kenya's economy. About 90% of the population live in the rural areas and depend on agriculture for their livelihood. It is impossible to imagine Kenya without agriculture and the rural people without their livelihood. Soil and water are the basic necessities for agriculture and information for their conservation ought to be given the appropriate regard to match the importance of agriculture in Kenya.

What is Information

Information implies experimental, theoretical and observational knowledge in soil and water conservation. Results of scientific research when extracted and put into various packages for different purposes are known as information. A theoretician who advances an idea that soil and water conservation measures should take into account cultural, traditional and monetary aspirations ought to be given credit. In the past conservation measures have succeeded in Machakos through 'Mwethya' Communal work, approach. The writer has observed a one time beautiful farm near Mau Narok go to ruins with gulleys simply because it was rented for wheat production and the renter was interested in the crop and not the soil. He chose the easier way of ploughing down the gentle slope! A farmer who refuses to continue terracing his land because he experienced crop failure in earlier terraced portions, ought to be given credit for his observational knowledge which is part and parcel of the nature of information.

NATURE OF INFORMATION FOR SOIL AND WATER CONSERVATION

Informal Information

There is a world of unwritten, oral information with rural farmers as a result of observation and experience. This should be tapped and exploited for the benefit of soil and water conservation.

Informal communication between soil and water conservation scientists is a manifestation of the wealth of information that is in existence. It is not unusual for researchers to communicate their findings through letter or pre-prints. Discussions during workshops and conferences is a clear indication of the apparent dormant knowledge.

Formal Information

The written information is available in many diverse forms:

Primary Publications

Journal articles, research reports, theses, conference proceedings. These are convenient as they are easily accessible through bibliographical guides.

Secondary Publications

Abstracting and indexing journals. These are used for current awareness and retrieval services. Information contained in these suffers the problem of delay in processing for use.

Tertiary Publications

Reviews, Bibliographies and Directories contain useful information and can be prepared to answer specific questions. A directory of current researches and researchers in soil and water conservation would be a very useful tool which would eliminate duplication and hence reduce costs.

Computer Tapes and Microfilms

Computers can store large quantities of information and handle and retrieve this with speed and flexibility. These are expensive and should not be given priority particularly when appropriate technology is being discussed so much today. Microfilm and microfiche are other forms in which information can be stored and disseminated. It can be stored in large quantities but requires special equipment to utilise it.

What is Available

To many researchers unless they happen to know that particular information exists, they assume that it does not exist. And if it does, it is probably out of date and there is no need to look for it. Appropriate technology is however proving that old, simple techniques are worth trying in spite of space age technology. In their assumption of non-existence of information, researchers write up proposals, carry out experiments, trials, research projects and meet at workshops to report and discuss their findings just to find later a lot had been done before! Plenty of saving in time, effort and, of course, money could have been achieved if they were informed.

To be well informed one requires a package of information in a suitable form, knowledge of its existence and the techniques of how to find and use it. Existence of information demands its production, collection, processing and organisation.

Information for soil and water conservation in Kenya started evolving in the mid thirties after soil erosion became a real problem. Before the thirties, the concern was on soil fertility, crop and animal diseases and new crops. Then came erosion at the turn of the 1930s. The first comprehensive publication on soil erosion was issued by the Department of Agriculture, Division of Plant Industry as Bulletin No. 1 in 1935. Entitled 'Soil Erosions,' it discussed the dangers of wide-spread deterioration of land, and the occurrence and methods of preventing soil erosion. Copies were distributed to farmers, administrative and agricultural officers. Informal information was passed to farmers during field days by way of demonstrations and also at barazas.

The growth of formal information between 1930 and 1980 is marked by a notable decline during the 1940s which reached rock bottom in the 1950s. It started to rise in the 1960s and gathered momentum in the 1970s. (see diagram). Between 1930 and 1980 over 150 articles, reports and pamphlets on soil and water conservation were published in primary publications. The combined total pages approximate 3,500 which is no mean figure.

Growth of Information on Soil and Water Conservation 1930 - 1980

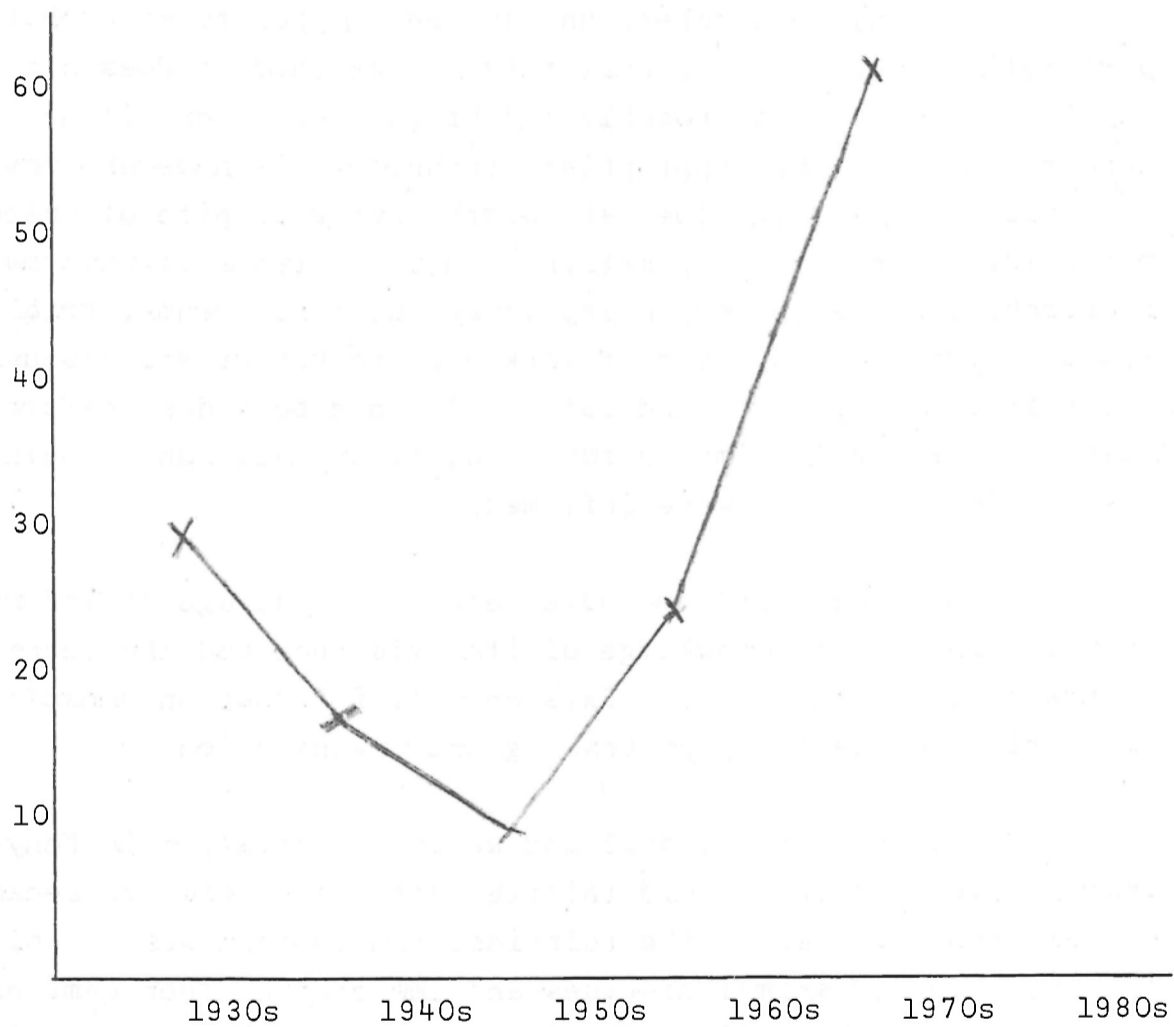

Growth of Information on Soil and Water Conservation
1930 - 1980.

PROBLEMS AND SUGGESTED SOLUTIONS

Scatter

The existing information is scattered all over primary publications locally and overseas with no bibliographic control tool. This scatter is expected to continue and maintain the impression of non-existence of information. Some attempt at control, is being made by the Kenya Agricultural Documentation Centre through KADOC Abstracts and by Egerton College through 'Recent Literature of Kenya Agriculture' in Egerton College Agricultural Bulletin. These are however too general to satisfy the needs of specialised researchers. Information for soil and water conservation is so important that it is necessary to establish and maintain bibliographic control.

Dissemination Problems

Reports from government ministries and international organisations are unduly classified. Declassification processes take long or are never done. Why should technical information which has nothing to do with security be classified? Why should technical documents end up in files to await burial at the National Archives or emerge first in Rome or elsewhere. Technical information of non-security nature should not be classified information.

Publication Problems

The number of local primary journals is limited. There is no guarantee that articles will be published. Hence authors tend to send materials overseas with great expectation of some prestige. Publishing information about Kenya outside Kenya is not in the best interests of Kenya but in the interest of the author. Attempts should be made to ensure that facilities are available for researchers to publish locally.

Lack of Knowledge in Information Usage

Studies in usage of information indicate scientists prefer simple straight-forward methods e.g. talking, scanning and browsing and informal communication. Some depend on 'Information Gatekeepers' i.e. individuals with desire and ability to secure information and circulate to colleagues as a mark of scholarly achievement. Soil and water conservation scientists in Kenya are probably no different. It might be worth while to undergo instruction in the use of information e.g. how to establish information control, how to do literature search etc. Workshops and seminars on how to use information are accepted and expected features for science and technology in developed countries.

Lack of Co-ordination in Information

Information for soil and water conservation is generated at various places. A number of government ministries, international organisations, educational institutions and commercial firms are all involved in soil and water conservation in one way or another. The information generated in these ought to be available to anyone interested.

It would appear that there is need to have a national technical information centre under the guidance of the highest possible authority. This should co-ordinate all the technical information in the country. In doing this, it should be responsible for generation, production, collection and organisation of information. This is in line with the recommendation of the National Council for Science and Technology put forward in the Kenya National Paper for United Nations Conference on Science and Technology for Development, The need to acquire and catalogue information produced in the country has been realised. The situation calls for the establishment of a National Bibliographic Service.

REFERENCES

1. Beck, Gerhard. 1978. Seminar use of documentation and information for planning and decision making. Nairobi KNAAS 36 pp.
2. Beck Gerhard. 1979. Information and documentation, the challenge of the future. In John B. Castellino & Canute, P:M: Khamala (Ed): The role of water resources in development. Proceedings of the 13th Annual Symposium of the East African Academy September 1977. Nairobi KNAAS pp. 278-282.
3. Gray, John; Pery, Brian. 1975. Scientific information: Oxford University Press 62 pp.
4. National Council for Science and Technology. 1979. Kenya National Paper for United Nations Conference on Science and Technology for Development, Nairobi. National Council for Science and Technology.
5. Kenya Science and Technology Act 1977. No. 3 of 1977.

Editor's Note. This paper was presented together with a bibliography containing nearly 150 references. It is hoped to incorporate this bibliography with that prepared by library staff at the University (Kabete Campus) and to publish a joint bibliography in due course.

AN INTEGRATED APPROACH TO LAND DEVELOPMENT AND SOIL
CONSERVATION IN AN AGRICULTURAL SETTLEMENT PROJECT:
THE MAGARINI EXPERIENCE

By

C. M. Adamson,
I. R. Melville,
G. T. Kariuki
Magarini Settlement Scheme,
Department of Settlement,
Malindi.

INTRODUCTION

The Magarini Land Settlement Scheme is a joint Kenya and Australian Government funded settlement project. The Department of Settlement is the administering body. The Australian component is contracted to the Australian agricultural consulting firm of McGowan International from the Australian Development Assistance Bureau.

The project is located approximately 35 kilometres north west of Malindi. The area has a semi-arid climate; water is the main constraint to development and this has restricted existing land use to subsistence farming during the wet season. Land use intensity is not great and the main occupants of the area are the Giriama people with a small inclusion of the Wasanya tribe. The area has been little developed and basic infrastructure of roads, schools dispensaries etc. is poorly developed.

The aim of the Project is to improve the living standards of the people in the area by providing the means for permanent settlement of existing squatters. This calls for provision of a water reticulation system, road, and other infrastructure services, the layout and clearing of plots and the development of a farmers co-operative.

Initially an area of 40,000 hectares has been identified and gazetted. This forms the first phase of the project and approximately 2,500 plots will be settled. It is hoped that the project will be repeatable and be extended to include other similar areas. Already an area to the south of the project towards the Sabaki river is now being surveyed for extension of the project.

Following the initial proposals, an evaluation program was carried out between 1976 - 1978. During this time basic resource inventories were completed and a hydrometeorological network was established. In 1979 the implementation phase began and to date almost 700 plots have been developed and settled.

2. THE PHYSICAL ENVIRONMENT

2.1 Climate

Two climate stations are maintained in the area by the Ministry of Water Development. One station is at Marafa and has a station record of 4 years. The other station is located at the General Investigation Station and has been established for a year. Both stations measure the main climate variables. These are listed in Table 1. Longer term daily rainfall records are also available within the area.

The climate of the area is semi-arid and rainfall is the limiting factor to agricultural production. There is a bimodal rainfall distribution with both long and short rainfall seasons which are initiated by the change in the monsoonal wind direction.

The long rains are reliable and generally bring 65-70% of the annual rainfall. The long rains occur during the South-East trades and commence in late March/early April and last until June/July.

The short rains are unreliable and frequently fail. These may bring 20% of the annual rainfall and occur during November/December when the winds swing to the North East.

High rainfall intensities can be recorded from isolated storms at the onset of the rains. Most soil erosion is recorded at the commencement of the long rains when heavy storms coincide with poor ground cover conditions. For the remainder of the season rainfall intensities decrease but rainfall duration and areal extent increase. Thunder is rare.

2.2 Runoff

Two gauged Catchments together with two gauging station on the Ngandi River system were established in 1977. These are now maintained by the Ministry of Water Development.

Depending on the amount of rainfall, runoff can occur from both the long and short rain seasons. However, runoff occurs more frequently during the long rains due to the greater rainfall reliability and amount. On small catchments, runoff can occur from both localized high intensity short duration storms and general long duration falls. On the larger catchments such as the Ngandi River, periods of prolonged general rainfall are needed before flows occur. Records to date (anon - 1980) show an average annual runoff yield of 73 mm. for the smaller catchments. This converts to an equivalent yield of 730 m³ of runoff water per hectare per year or 7.5% of rainfall.

2.3 Land Form

Topography within the present development area consists of gently undulating land with a maximum elevation of 150 metres at Magarini ridge. Relief consists of a system of ridges with broad flat crests which gradually increase in slope towards drainage lines. Most of the land slope is less than 8%.

2.4. Soils

Two pedological surveys (anon 1977, McGarity 1980) and one survey on soil/water relationships (Njihia and Owido 1981) have been carried out for the project. Soil fertility analyses are also available.

Of the soils identified, the following are the most relevant and are ranked in order to occurrence.

1. Black earths of the solonetz group.
2. Duplex yellow earths.
3. Light textured, gradational grey sodic solonetz soils.
4. Rendzinas.
5. Black swelling plastic clays.
6. Acid sands.

1. Black earths of the solonetz group. Northcote Key Gn 3.43 (Northcote 1979) Typically, these are sandy clay loams within the 35 cm A horizon. Clay content increases to sandy clay at the B horizon. They have a very high infiltration and a high erodibility rating.

2. Duplex Yellow Earth. Northcote Key Dy5.33 (5.23). These are sandy loams over sandy clay loams. A₁ horizon is present, varying upto 15 cm. They have a high infiltration and a high erodibility rating.

3. Gradational grey sodic solonetz soils. Northcote Key Gn 4.53. Sandy clay loam increasing to sandy clay. A₁ horizon is 15 cm. Total A horizon is 40 cm. Infiltration is high. They are highly erodible, the B horizon being extremely so.

4. Rendzinas. Non cracking brown friable plastic clays. Northcote Key Uf6.32. A₁ horizon is upto 15 cm. A₂ is a further 15 cm. They are well drained, have moderate to rapid infiltration and

Table 1: Meteorological Summary - Marafa Average 4 Years 1978 - 1981

| Month | Rainfall (mm) | Rain Days | Temperature | | Wind Run (Km ² m) | Evaporation (mm) | Sunshine (hrs) |
|-----------|------------------|--------------|--------------------|--------------------|---------------------------------|---------------------|-------------------|
| | | | Max ^o C | Min ^o C | | | |
| January | 52.5 | 6 | 32.4 | 22.5 | 1641 | 142.6 | 217.3 |
| February | 31.6 | 3 | 32.5 | 22.2 | 2357 | 142.1 | 206.5 |
| March | 107.8 | 7 | 33.1 | 23.2 | 2558 | 162.5 | 196.2 |
| April | 84.0 | 5 | 32.5 | 23.3 | 2840 | 160.4 | 216.8 |
| May | 191.4 | 13 | 30.4 | 22.6 | 3944 | 135.0 | 167.7 |
| June | 90.1 | 8 | 28.3 | 21.0 | 3776 | 124.1 | 193.7 |
| July | 82.4 | 13 | 27.4 | 20.2 | 4267 | 128.1 | 177.2 |
| August | 72.8 | 10 | 28.3 | 19.1 | 3957 | 136.9 | 186.6 |
| September | 39.8 | 9 | 29.6 | 19.9 | 3787 | 152.1 | 219.4 |
| October | 29.1 | 4 | 30.4 | 21.2 | 3282 | 178.9 | 241.8 |
| November | 109.7 | 8 | 31.8 | 22.5 | 2201 | 143.9 | 199.7 |
| December | 81.6 | 7 | 31.8 | 22.7 | 1829 | 151.0 | 186.6 |
| TOTAL | 972.8 | 93 | | | 36439 | 1758.2 | 2408.9 |

good water holding capacity. Permeability is moderate to slow, erodibility rating is moderate.

5. Black swelling plastic clays. Northcote Key Ug 5.15. These have a self mulching surface and a deep (60 cm) A horizon. They are well drained, fertile with high infiltration. They tend to be confined to lower slopes and drainage floors. Erodibility is moderate.

6. Acid sands. Northcote Key Uc 6.13. These are excessively drained, low in fertility. Erodibility is variable. The 'Devils Kitchen' at Marafa is an example of highly erodible sands. The Magarini and Sosoni types are probably lower. They are suited to tree crops.

2.5. Vegetation

Much of the vegetation of the area has been altered by the shifting agricultural system used which has existed here for centuries. Ecological progression thus exists in a wide variety of stages from grassland and low scrub invaders through to a woodland climax.

Three broad divisions of physiognomic classification are found throughout the current development area.

1. Bushland
2. Bushland/Bushland thicket
3. Woodland. No development has yet been carried out in this division.

The use of vegetation as an indicator for land use so far has been limited in Magarini. Obvious drainage floors and the forests along the Sabaki are small exceptions. More work

needs to be carried out to relate vegetation patterns in photo interpretation to land form and soils for land use appraisal.

3. INTERRELATIONSHIP OF PHYSICAL ENVIRONMENT ON SOIL EROSION

The interaction of the physical environment factors of climate, topography, soil erodibility and vegetation will determine the amount of soil erosion for that area. This is further affected by seasonal conditions which alter surface cover.

In the Magarini environment soil erosion is seasonal and is mainly affected by the interaction of surface cover conditions and rainfall erosivity. The hot dry conditions prior to the onset of the long rains desiccates vegetation which can be further aggravated by overgrazing and burning. The breaking storms are frequently of high intensity/erosivity and consequently highest erosion rates occur at this time. With time, better ground cover conditions establish and soil erosion declines. Due to the vegetation's ability to 'hang on' after the long rains, surface cover conditions are still satisfactory by the onset of the short rains and soil erosion is lessened.

4. LAND DEVELOPMENT PLANNING PROCESS

Land Development commences with the planning of the subdivision of the Settlement area into small holder plots. The planning process acknowledges that the semi-arid climate limits production, while land is presently readily available. Hence plot size is planned at 12 hectares. This has been determined by budget and labour studies to be the optimum plot size for a small holder family to achieve an economic return from both cropping and livestock production.

All planning is done on 1: 10,000 scale, 5 metre contour topographic maps. The ridge road system is planned first. This consist of main through access roads which follow the principal ridges. Secondary feeder access roads are then planned, which terminate at the end of the ridge.

Areas of agricultural capability and hazard are then identified and excluded from development. These include areas of excessively drained, leached and infertile sandy soils, all lands over 8 per cent slope, streams and natural water disposal areas.

Plots are then planned on the remaining areas. Plot boundaries run from ridge to the water course and are located wherever possible at right angles to the contour so as to avoid runoff from soil conservation structures spilling into neighbouring plots. Reserve areas for towns, schools, forests, health centres or surface water storages are also identified.

5. FIELD OPERATIONS

5.1 Land Development

The plot layout is then transferred to the field. First the road lines are laid out by a Surveyor and cleared with a bulldozer. Next the areas to be cleared (approximately one third of each plot or 4 hectares) are delineated on the ground by cut lines.

Clearing then commences. To achieve targets, contractors are preferred and have carried out the bulk of the work to date. Various clearing methods, production rates and comments, regarding the methods are given in Table 2.

Blade clearing has been the most commonly employed method due to machinery availability. More recently push clearing with a root rake and root ploughing methods have been used. While these remove less soil and leave a better finished job there is little time advantage with this method due to the high power requirement of the root plough.

Chaining was not successful as the material could not be burnt 'in situ' and required further tractor time to windrow into heaps.

Table 2: Evaluated Results Clearing Methods

| Clearing Method | Details of Operation Required | Tractor/Labour Requirement | Production Rate Hrs/ha or m.d* | Cost Ksh./ha | Comments |
|--|---|---|--------------------------------|--------------|--|
| Blade clearing | i Blade clearing to windrows ii Burning windrows iii Respreading | D6-D7(140-170h.p) D4-D5(65-90h.p) | 4.0 | 2000 | Uses conventionally equipped tractors. Excess topsoil disturbance and removal to windrows can be a problem. "Spring-back" vegetation can remain. Uneven ash distribution. Most commonly used method |
| | | | 12m.d 1.4 | 120 700 | |
| Total | | | 5.4hr 12m.d | 2820 | |
| Bush Clearing with root rake & root Plough Total | i Root raking/ploughing to windrows ii Burning windrows iii Respreading | T.D 25 (240h.p) D4-D5(65-90h.p) | 3.9 | 1950 | Uses specialized equipment, not readily available. Topsoil removal to windrows can be reduced. Root plough needs to be used with root rake to sever "springback" vegetation. Finished job is very clean. Uneven ash distribution. |
| | | | 12m.d 1.4 | 120 700 | |
| | | | 5.3hr 12m.d | 2770 | |
| Chaining | i Pulling ii Windrowing iii Burning iv Respreading | 2x D6(140h.p) D6D(140h.p) D4-D5(65-90h.p) | 1.7 | 850 | Uses conventional tractors with bulldozers. Chaining is done in 2 passes, one in the opposite direction. High production rare but unsatisfactory due to poor kill and impossible to burn without windrowing. Uneven ash distribution |
| | | | 2.2 | 1100 | |
| | | | 12m.d 1.4 | 120 700 | |
| | | | 5.3hr | 2770 | |
| Total | | | | | |
| | | | | | |
| Heavy Discing | i Discing & picking ii Burning & picking | D7(170h.p) | 1.4 | 700 | Requires large tractor with drawbar & set of heavy discs. High production rate. Best suited to light open bush. Burning gives reasonable disposal |
| | | | 13m.d | 130 | |
| Hand Clearing | i Hand cutting ii Burning iii Heavy discing | 170h.p tractor | 1.4hr 13m.d | 830 | Method is slow, gives even ash disposal. After heavy discing the plot has to be destumped and is available for settlement. Actual costs to clearing are Ksh. 860/per ha. |
| | | | 51m.d/ha | 600 | |
| | | | 26m.d/ha 2.0hr/ha | 260 1700 | |
| Total | | | 2.0hr 77m.d | 2560 | |

* m.d. = Mondays

Heavy discing, apart from its initial evaluation has not been used extensively due to shortage of adequate machinery.

Hand clearing is inexpensive but its production rate is slow. Stump removal remains a problem and root ploughing rather than discing could improve the finished job.

5.2. Soil Conservation

Existing erosion under the present system of shifting cultivation is negligible, however the proposed changes in land use, with cultivation of large areas will expose the easily eroded soils. This will lead to rates of erosion far higher than is tolerable should no preventative measures be included in the land development phase.

Soil conservation bank channels are laid out at 1.5m vertical intervals on 2 - 5% slopes. On slopes over 5% a 2.0 metre vertical intervals is used. Layout is done using automatic levels which are fast and accurate. Approximately 0.65 km of bank channel is required for each plot. To date 210 km have been constructed. For stage 4 with 450 plots to be done this represents the layout and construction of approximately 200 km. Banks with triangular channel shapes are then constructed using a 160 horsepower Komatsu grader. Construction using the grader is fast and up to 2.0 km can be constructed in a day. The grader is also used to construct the waterways when these are needed.

Following completion, waterways are sown with a mixture of buffel grass (Cenchrus ciliaris) and Sorghum spp. Natural regeneration of native grasses is also rapid once the rains commence. The banks of the terraces are planted to sisal. Sisal has been chosen since it provides a living fence to keep animals off the cropped areas.

Leucaena leucocephala, bana grass and citrus are also being tested for planting on the banks.

Wherever possible the soil conservation works are integrated into a water harvesting system that stores runoff for use during dry periods. With average expected runoff yields of 730 m³ per hectare per year considerable quantities of water can be harvested and directed to surface storages by way of the graded banks and waterways. At the General Investigation Station a system of ten pairs of graded banks 200 metres long have been set out at 40 metre spaces. The water harvested from these catchments is directed to an 8 metre wide waterway which carries it downslope to an 8000 m³ surface storage. This filled after two long-rains seasons and is now being used for stock water and irrigating vegetables. The dam is designed to meet demand without failing for a period of up to 18 months without runoff.

5.2.1 Soil Conservation Design

Earthwork design has been considered in relation to several formulas in world use. A common formula in use in Australia for interbank spacing is:-

$$VI = \frac{K \sqrt{S}}{100}$$

Where VI = Vertical Interval (m)

K = a constant, based on rainfall intensity, and modified by geographic and land use factors.

S = slope %

For Magarini conditions, a K value of 100 has been adopted. Bank design is based on peak discharge for the 1 in 10 year recurrence interval as determined by the Rational Method formula:-

$$Q = \frac{CIA}{360}$$

Where Q = Discharge (m³/s). C = the coefficient of runoff, i = rainfall intensity (mm./hr) for an expected storm of a duration equal to the time of concentration to the discharge point. A = the area (ha.)

Bank dimensions are determined by the cross sectional area formula.

$$a = \frac{Q}{V} \quad \begin{array}{l} \text{(peak discharge - m}^3\text{/s)} \\ \text{(Velocity - m/s)} \end{array}$$

and V is determined by Manning's formula

$$V = \frac{R^{2/3} S^{1/2}}{n}$$

Where R = hydraulic radius (m), which is a/P where a is cross-sectional area (m²) and P is the wetted perimeter of the channel (m). n is the coefficient of roughness or the retardance effect of the channel surface.

Velocity has to be no greater than the maximum permissible velocity of the flow before scouring in the channel occurs. For example, in a bare earth channel on a black solonetz soil which has a high erodibility rating, the recommended maximum permissible velocity is 0.5 metres per second. Channel grades on the Project do not usually exceed 0.35%. On sands where excessive drainage exists, channels are level.

Waterways are also designed using Manning's formula.

6. MAINTENANCE OF SOIL CONSERVATION STRUCTURES

Under the system of subsistence cropping which had been carried out with low population pressure, little soil degradation occurred because after cropping the area was returned to a protective scrub cover again.

Now with more intensive settlement on a defined area and a more intensive land use system being imposed following a large clearing program, the potential for large scale soil degradation has been increased. The construction of the soil conservation terraces on the cleared areas will provide initial protection but it is imperative that these be maintained and that other soil conservation management practises such as contour planting be adopted.

Soil conservation principles are not well understood by the local people and the agricultural extension program is used to educate the farmers in this field. Talks and demonstrations are given on the causes and effects of soil erosion. Maintenance of structural works and improved soil management system such as contour planting and preservation of organic material are also included.

7. THE FUTURE

7.1 Land Development

The present method of land clearing using bulldozers is expensive and also results in excessive topsoil disturbance and removal to the windrows. Ash disposal is uneven affecting later crop yields.

Proposals aim at making clearing more economical, reducing topsoil disturbance and evening ash disposal while maintaining high production rates. A chopper roller has these characteristics and will be evaluated. It is also likely that hand clearing will receive greater attention due to its lower cost and the advantages of creating local employment. However, it leaves stumps behind requiring expensive treatment such as root ploughing which increases land development costs.

7.2 Soil Conservation Research

Within Kenya greater attention is now being given to farming marginal areas. Due to their very nature the fragile environments of these areas can be easily upset by over exploitive use resulting in soil erosion and their eventual abandonment. To avoid this, stable farming systems must be set up which must also be economically viable.

Research is given the role of evaluating these systems. The main areas of research which are needed are:-

- (i) Development of soil and water conservation farming systems.
- (ii) Verification of soil loss prediction equations as a land management aid.

This research could best be carried out on both small catchments and runoff plots. Managements of runoff yield, peak rates of discharge and soil lose should be recorded.

7.3 Conservation Farming

Other practises such as conservation farming system which involve crop residue management, contour ridging, small

catchment control and water harvesting, crop/ley rotation and grazing control, need to be evaluated.

Trials and experiments to develop the cheapest and most effective means of weed control with minimised tillage (for soil structure and moisture maintenance) together with precision sowing for accuracy in crop plant population and spacing; as well as effect of intercropping and extended cropping, are also required.

McCarthy J.W. (1980) 'Report on soils and Soil Management on the Magarini Land Settlement Scheme, Malindi, Kenya'. McGowan International, Albany, N.S.W., Australia.

Njiru C.M. and Odiit S.F.O. (1981) 'Infiltration and moisture Storage Characteristics of the Magarini Land Settlement Scheme Coast Province, Kenya'. Ministry of Agriculture, Irrigation and Drainage Research Project.

Northcote K.H. (1979) 'A factual key for the recognition of soils'. Rellin Technical Publications, Adelaide, S.A., Australia.

REFERENCES

- Anon. (1977) 'Land Inventory and Capability' Annex 5
G.P. McGowan and Associates Pty Ltd., Albury
N.S.W., Australia.
- Anon. (1980) 'Review of Hydrological and Meteorological
Analyses and storage Operation Studies' Snowy Moun-
tains Engineering Corp. Cooma, Australia.
- McGarity J.W. (1980) 'Report on soils and Soil Management on
the Magarini Land Settlement Scheme, Malindi, Kenya'
McGowan International, Albury, N.S.W., Australia.
- Njihia C.M. and Owido S.F.O (1981) 'Infiltration and moisture
Storage Characteristics of the Magarini Land Settle-
ment Scheme Coast Province, Kenya' Ministry of Agri-
culture, Irrigation and Drainage Research Project.
- Northcote K.H. (1979) 'A Factual Key for the Recognition of
Soils' Relim Technical Publications. Adelaide, S.A.,
Australia.

THE 'COUNTER CONTOUR' SYSTEM OF SOIL AND WATER
CONSERVATION AND LAND DRAINAGE.

By

J.M. and G.M. Nightingale
Sasumua Estate, Njoro.

The concept of the Counter Contour system was devised by Mr. J.M. Nightingale when he was farming two properties on the South Kinangop. One was a series of long ridges with steep valleys coming off Kinangop mountain. The other was a more undulating, rectangular block in the middle of the plateau consisting of swamp and shallow valleys. Mr. Nightingale evolved and developed the system when, in his opinion, standard methods of soil conservation on their own were inadequate and sometimes caused considerable damage.

Before these farms were counter contoured only small portions could be safely used for agriculture. After re-planning and counter contouring they became 100% usable and highly productive. We claim the system conserves both soil and moisture, prevents waterlogging and aids farm planning. Natural springs and streams become more permanent and water courses are no longer subject to floods.

In its simplest form the system enables rain water to move in places where it has difficulty in doing so and slows it down to a speed where it will percolate into the ground and deposit soil rather than erode it. To understand the system, it is necessary to realise that almost all land surfaces have slopes in two down-hill directions; 1) the slope of the crest or nought point of the ridge roughly parallel to the slope of the river or valley on either side of it; and 2) the slope at right angles to the crest down to the valley bottom. Once these two basic slopes are fully understood, the whole principle of counter contouring is easy to follow. To take 'DRAINAGE') first:- What is required is a lowering of the water table sufficiently to allow the crop or pasture to thrive without waterlogging (See Fig. 1) and to let excess water move away gently and become

absorbed as much as possible before reaching the natural drainage way. The same becomes true with 'SOIL AND WATER CONSERVATION':- i.e. as much precipitation as possible should be absorbed where it falls and only the excess should move gently over as long a distance as possible and also become absorbed into sub-soil rather than rushing in large volumes down slopes taking vast quantities of soil (soil erosion) to the nearest cut off or stream. Under this system, we found that a gradient of $\frac{1}{2}\%$ (i.e. six inches in one hundred feet) fitted all these requirements. With this $\frac{1}{2}\%$ gradient under the counter contour system, water will flow enough not to erode and most of it will become absorbed and only a minimum will leave the land. Hence in porous soil such as Menengai volcanic ash the water hardly moves at all while in a clay type of soil of poor structure the water will flow enough to allow percolation into the ground.

On counter contours the concept of vertical intervals, which is considered so important in standard conservation practises, should be ignored and rather the concept of how far water moves before it is directed to the $\frac{1}{2}\%$ gradient should be considered. Irrespective of normal hillside slopes, practical experience indicates that a maximum of 15 metres and a minimum of 7 metres (approx) between the crests of the counter contours creates the best land profile. Where slopes become too steep for mechanical cultivation these figures can be reduced (Fig. 1). On a 15 metre interval rain water will move a maximum of $7\frac{1}{2}$ metres either way before coming under control. In this short distance there will be insufficient accumulation or velocity to cause erosion. With less than 7 metre intervals the ridges will be too steep for easy cultivation.

In standard soil conservation practises the aim appears to be to lead excess rain water on suitable grades as soon as possible to the nearest drainage way whereas our Counter Contour system aims to keep the rain water on the land as long as possible for absorption and deposition of silt and only the final excess is able to find its way via standard permanent well constructed and grassed road drains and standard contour

cut-off ditches to a designated drainage way. In our system any movement is towards the highest point possible on the ridge - the nought point - hence the name Counter Contour - counter to the standard practises. In answer to the frequently asked question 'how do you make water run uphill' Counter Contours are on a similar grade that would be used to draw water by furrow from a stream.

Before implementing the Counter Contour system, it is vital to plan the farm or block of land and to construct the necessary works such as standard contour ditches, nought point and access roads etc. The plan should be drawn to ensure fields are of a suitable size for ones operations (in our case 10 to 12 ha.). Each should be bounded by a natural drainage way, a nought point road ditch, and two standard soil Conservation cut-off ditches. These boundaries may be fenced with gates opening on to nought point roads. Intermediate Soil Conservation Service ditches are not required and should be discarded.

Having completed the above, the Counter Contour system should be superimposed. The counter contour lines can easily be marked out using the string level method by illiterate workers after a minimum of instruction, and the land formed and maintained by ordinary farm implements and even, in the case of small holdings, by hand labour. As in all soil conservation, maintainance of discharge points must be ensured. After marking out the Counter Contour with a string level, the land is 'FORMED' by ploughing, or one-way discing, to the crest, which is the marked line. This should be fairly accurate to avoid break-throughs, whereas the furrow will find its own line, as in the 'closing furrow' in standard ploughing. Any unevenness in the furrows will slow up the flow and act as a silt trap.

To recapitulate:- any water that moves - in practise this is very little - must first flow a maximum of $7\frac{1}{2}$ metres to the low point of the counter contour and then towards the crest of the ridge. It then moves a short distance down the nought point road ditch till it meets the standard Soil Conservation cut off. In land subject to water logging the water table is lowered to the level of the lowest portion of the

Counter Contour (Fig.I). Provided the land has been adequately formed in the preliminary cultivations, it is possible to harrow and sow in straight lines on an approx level to direction.

We maintain the Counter Contour System is valid for both steep and gradual slopes and for both high rainfall and arid areas and could enable marginal lands to become highly productive. The concept can be combined with other systems such as water harvesting, establishment of forests in arid areas, subdivisions into small holdings etc.

**FIG I CROSS-SECTION (MUCH EXAGGERATED)
OF COUNTER - CONTOURED LAND**

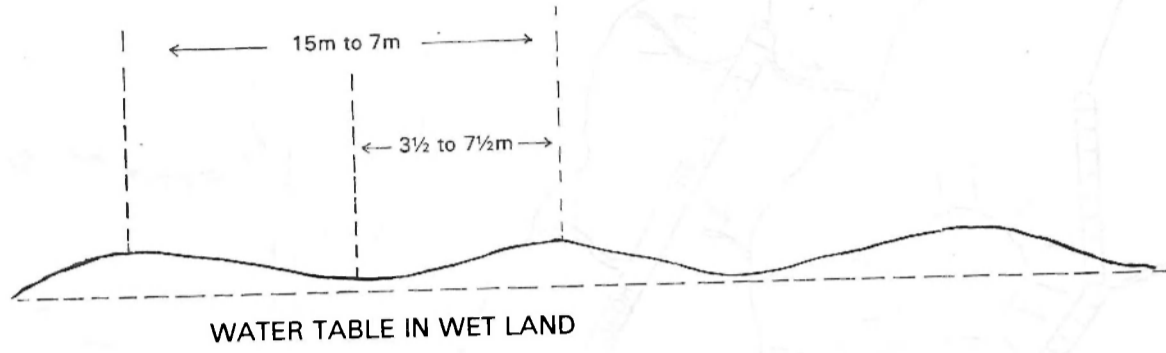

**FIG II COUNTER - CONTOURED FIELD SHOWING BOUNDARIES,
'O' POINT ROAD, LINK ROAD AND NATURAL DESIGNATED WATER COURSE**

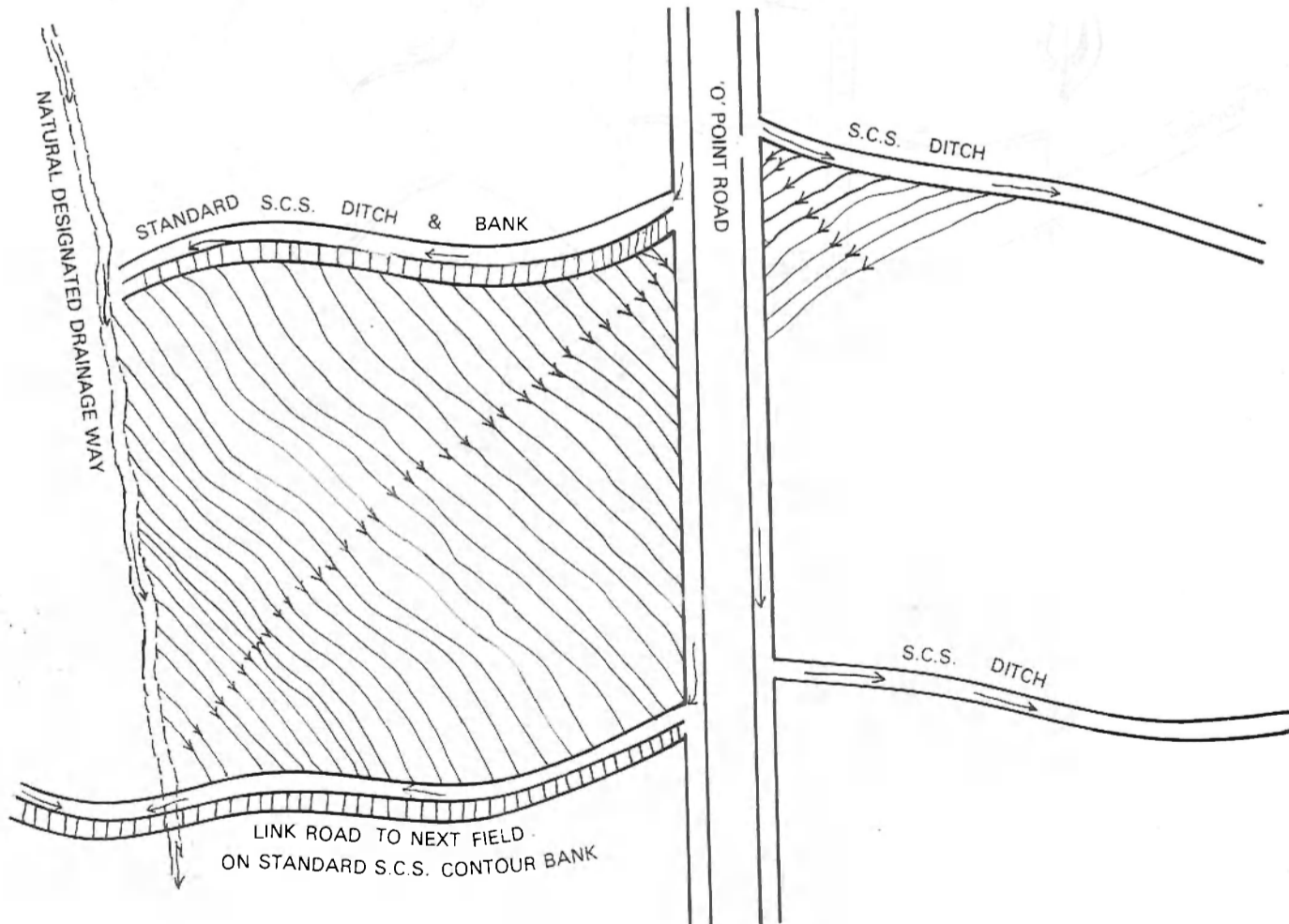
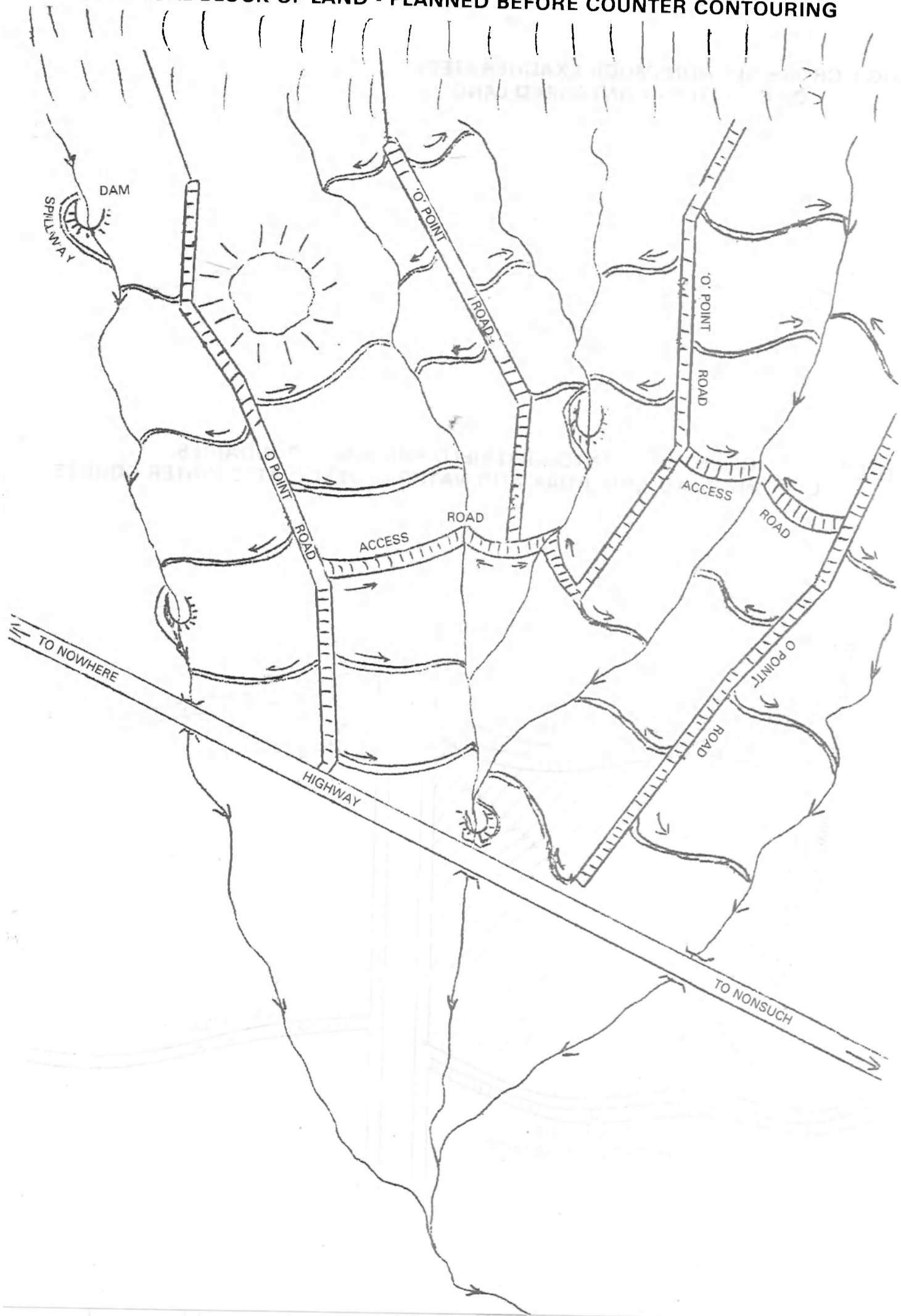

FIG. III
HYPOTHETICAL BLOCK OF LAND - PLANNED BEFORE COUNTER CONTOURING



THE DESIGN OF ARTIFICIAL WATERWAYS FOR
DENSELY SETTLED AREAS OF STEEP LAND

By

D.B. Thomas

Department of Agricultural Engineering
University of Nairobi

I INTRODUCTION

Artificial waterways are channels designed to receive runoff from cutoff ditches, road drains and terraces and to carry it down a slope to a point where it can be safely discharged into a valley bottom or stream. They are particularly necessary in the wetter parts of Kenya and in areas where there are insufficient natural waterways.

If artificial waterways are needed, they should be designed and constructed before other structures are installed but in the past this had not always been done. Runoff is sometimes discharged into a stock track or footpath which then develops into a gully. The main reason why artificial waterways have not always been developed when needed is the shortage of land and difficulty of finding an acceptable alignment. Nearly a half of all small holdings are under 1 ha. (Stats. Abstracts, 1980). In Muranga, for example, where the problem of waterways has already been noted (see report of field trip, Institute of Development Studies 1978), land can be worth upto Kshs 100,000 or more per ha. (Mwangi, 1982). Few farmers would therefore be keen to allocate land to a waterway. Even natural waterways are often used for cropping with Colocasia, bananas, etc.

A second reason for the lack of artificial waterways is that plot boundaries usually run up and down the slope in areas where land consolidation has taken place and are often used as footpaths or stock tracks. A third reason is that the capital available for purchase of materials and erection of structures is very limited. In some instances

road construction has led to the concentration of water and gullying. The control of such gullies and conversion to stable waterways can cost thousands of shillings and is far beyond the resources of the farmers affected.

The aim of this paper is to review the data needed and the factors which must be considered when designing waterways and to examine alternative solutions for densely settled areas of steep land. It is hoped that this will stimulate further studies leading to the development of standards and specifications which can be applied by field staff to different situations.

II LITERATURE REVIEW

The first reference to the need for waterways in Kenya is in the pamphlet on Soil Erosion by Beckley (1935). He notes that on steep slopes a grassed drain must be very wide to keep velocity down to acceptable limits and proposes two solutions, both of which were developed in Ceylon and are inexpensive. One is reproduced at the end of this paper (Fig. 3). Gil (1979) recommends the use of natural channels, improved if necessary in preference to artificial waterways and recommends the use of rhizomatous grasses, a point which is emphasised by most writers. Wenner (1980) suggests that artificial waterways can usually be designed for slopes up to 25% but that on steeper slopes drop structures are needed. Sheng (1977 and 1981) discusses various methods of constructing waterways and emphasises the need to divide runoff where possible rather than concentrate it, the need to use as much locally available material as possible and to select sites which minimise the cost of structures. His work is particularly relevant because he considers steep slopes which are densely settled but he does not discuss the engineering aspects of design.

Schwab et. al. (1981), Hudson (1971), Shaxson et. al. (1977) and Elwell (1977) discuss the engineering principles of design from which the following points emerge. Firstly, the channel must be designed so that water passes

at a non scouring velocity. The maximum permissible velocity is in the region of 1-2 m/s for grassed waterways. Second, the channel shape is normally assumed to be parabolic as this shape is more natural and calculations are relatively simple. Third, the basic design equations are:

- a) The Continuity Equation $q = va$
b) Manning's Equation $v = \frac{R^{2/3} S^{1/2}}{n}$

where q = discharge in m^3/s

a = area in m^2

v = velocity m/s

R = hydraulic radius = cross sectional
area / wetted perimeter (m)

n = Manning's roughness coefficient
(non-dimensional)

S = Slope in m/m

Fourth, Manning's roughness coefficient is not a fixed value but varies with velocity, depth of flow, channel shape and characteristics of the vegetation. The design procedure recommended usually involves a two step procedure on account of the change in Manning's n as grass grows. The first step is to design the waterway for stability when grass is short and velocity likely to be at a maximum. The second step is to design for capacity when grass is long and reduced velocity leads to a bigger cross sectional area of water (assuming that discharge remains the same).

The above writers are concerned with the situation where farming is mechanised, land is not scarce and slopes over about 16% would not be cultivated. They do not discuss the situation with which this paper is concerned and which is common in developing countries. In USA, in recent years, changes in farming practice have led to the development of underground piped drains for removing excess runoff as an alternative to grassed waterways which can then be ploughed

and cropped (Thomas, 1979). This is an interesting development but it is capital intensive and not appropriate for Kenya.

Mwaniki (1980) and Damba (1981) have studied typical situations in Muranga where problems with waterways have occurred. In four out of five situations which they studied slopes ranged from 20-28% and catchment areas from 0.7-13 ha. Wenner (1980) suggested that grassed waterways could be satisfactory upto 20-25% slope without drop structure and gives some data on recommended dimensions from a Malawi handbook simply based on catchment area without specifying the discharges concerned. There is clearly a need to see in what way the basic engineering principles can be applied to the design of grassed waterways for steep slopes where land is short.

III DESIGN CRITERIA

The procedures which are discussed below clearly involve a substantial element of informed guesswork but provided this is recognised it should still be better to design waterways on engineering principles rather than on rules of thumb.

Any attempt at an engineering design involves an estimation of expected discharge (usually based on a ten year return period) which can be done for small areas using the Rational formula.

$$q = \frac{CiA}{360}$$

where q = discharge in m³/s

C = runoff coefficient (from 0 - 1)

i = rainfall intensity mm/hr

A = area in ha.

provided that data on area of catchment (A), rainfall intensity (appropriate to time of concentration) (i) and the proportion of rain becoming runoff (C) can be estimated. An alternative method of estimating discharge is to use Cook's empirical method which has been adapted for African conditions (Hudson, 1971, pp. 112-115).

Information is also needed on slope percentage and length, type of cover (which affects the maximum permissible velocity and value chosen for Manning's roughness coefficient), the availability of land and the soil type. In general capital is short and designs should reflect this.

The way in which the above factors affect the design is discussed below.

3.1. Estimating Discharge

Whether the Rational formula or Cook's method is used as estimate of area is needed.

3.1.1 Area (A)

Estimation of area is not always straight forward and may be one reason why development of waterways has been slow. It is unlikely that field staff will have the time to make accurate topographic surveys and in view of the assumptions made in estimating q it seems unnecessary to demand a high accuracy in determining area. Nevertheless it is necessary to cover the ground on foot in order to find out what road drains, cutoffs, etc. already exist and where they discharge. Aerial photos may help to indicate crest lines and catchment boundaries but the natural drainage system is often altered by road making.

The easiest approach to mapping the catchment is probably to pace along compass bearings from known points on the proposed waterway alignment to the catchment boundary. It should be noted, however, that the catchment includes the whole area which drains to the lowest end of the waterway.

In view of the need to reduce the concentration of runoff wherever possible a catchment area of about 10 ha. could be considered a desirable limit for most artificial waterways.

3.1.2. Rainfall Intensity (i) and Time of Concentration (T_c)

If the Rational formula is used an estimate of time of concentration is needed but is difficult to determine. Assuming reasonable conservation practises which retard runoff a figure of 0.2 - 0.3 hr might be appropriate for catchment up to 5 ha and 0.4 - 0.5 hr for catchments from 5-10 ha. The appropriate figures for rainfall intensity at Muranga (Republic of Kenya, 1978) would therefore be:

Table 1. Time of concentration and rainfall intensity based on ten year return period (rainfall data from Republic of Kenya, 1978, p. 102).

| Time of concentration (hr) | Rainfall intensity (mm/hr) |
|----------------------------|----------------------------|
| 0.2 | 127 |
| 0.3 | 113 |
| 0.4 | 102 |
| 0.5 | 83 |

The ten year return period is normally used for intensity when designing agricultural structures but this allows a considerable safety margin because the peak storm does not necessarily coincide with the situation where the ground is saturated and minor depressions filled (i.e. maximum runoff).

3.1.3. Runoff Coefficient (C)

Some values of C are given in a paper on the Computation of Floods in Kenya (Water Development Division 1970) which are derived from elsewhere but are probably adequate

in the absence of local data. They are as follows:

Table 2. Values of C for use in Rational Formula (from Water Development Division, 1970).

| Type of catchment | Large | Small & Steep |
|---|--------|---------------|
| 1. Rocky & impermeable | 0.8 to | 1.00 |
| 2. Slightly permeable, bare | 0.6 to | 0.80 |
| 3. Slightly permeable, partly cultivated or covered with vegetation | 0.4 to | 0.60 |
| 4. Cultivated absorbent soil | 0.3 to | 0.40 |
| 5. Sandy absorbent soil | 0.2 to | 0.30 |
| 6. Heavy forest | 0.1 to | 0.20 |

If a catchment has several distinct types of land then a weighted average value of C can be used based on the area of each type.

3.2. Slope

In order to arrive at some figures for typical slope percentage and length for the areas with which this paper is concerned, measurements were made from the 1:50,000 map (sheet Mangu 134/4) of land in the valleys of the Thika, Ruchu and Makindi Rivers. Although height cannot be determined very accurately from the map the following figures give an indication of the prevailing situation.(Table 3).

3.3. Ground Cover and Soil Type

The nature of the cover is of great importance in the design of vegetated waterways. In the first place it affects maximum permissible velocity at which water can flow without causing scouring. With very good cover on erosion resistant

Table 3. Slope characteristics in three river valleys in Kandara, Muranga.

| River Valley | No. of observations | Distance from ridge crest to river m | | Slope: ridge crest to river % | |
|--------------|---------------------|--------------------------------------|---------|-------------------------------|-------|
| | | mean | range | mean | range |
| Thika | 28 | 370 | 150-550 | 30 | 17-43 |
| Ruchu | 17 | 384 | 150-700 | 29 | 14-40 |
| Makindi | 28 | 346 | 150-650 | 24 | 11-40 |

soils, this can reach 2 m/s or more but under poor conditions it may be half this value. Fortunately in the area with which this paper is concerned both Kikuyu grass (Pennisetum clandestinum) and Star grass (Cynodon sp) occur naturally. They are both capable of forming a thick cover. The following data is given in the Malawi Handbook (Shaxson et. al., 1977). The

Table 4. Maximum permissible velocity for waterways (from Shaxson et. al., 1977).m/s

| | Clay soil | | | Sandy soil | |
|------------------|--|------|-------|------------|------|
| | 0-5 | 5-12 | 12-20 | 0-5 | 5-12 |
| Star grass | 2.1 | 1.8 | 1.5 | 1.5 | 1.2 |
| Paspalum notatum | 2.4 | 2.1 | 1.8 | 1.8 | 1.5 |
| Stone lined | full width stone with grass at side 3.0 m/s centre third stone rest good grass - figure shown in table + 0.3 m/s. | | | | |

type of cover also determines the value of the roughness coefficient 'n' used in Manning's equation.

Design is sometimes carried out using a fixed value for n (e.g. n = 0.04) but in reality n varies with length of grass, velocity of flow and channel shape (Schwab, 1981). In the USA, grasses have been grouped according to their retardance characteristics but this has not yet been done for Kenya.

In Manning's equation if R and V are constant s is proportional to n^2 . Therefore a small change in the value of n makes a much bigger change in the value of S. The values of n for star grass (Bermuda grass) given by Schwab vary from a minimum of 0.03 to a maximum of 0.11 or about three times. If the upper value was chosen instead of the lower value, it would mean that the same waterway could be about ten times steeper (assuming V and R constant).

Elwell (1977) argues against using an 'average' value for n and recommends the two step process mentioned earlier. This is suitable for the large farm but is probably less appropriate for the small farm because under intensive land use the grass would normally be grazed down. If a single value for n is used it is clear that the value chosen makes a considerable difference to the design. Local data on values for n is unfortunately almost non-existent. Wacira (1979) found that star grass had a higher roughness coefficient than Kikuyu grass but was only able to apply small discharges in his experiment and the values he found for both grasses were high.

3.4. The Availability of Land and the Soil Type

Shortage and high value of land impose a major restriction on the design of artificial grass waterways which should as far as possible be wide and shallow. For general purposes 2 m top width could be considered a practical limit though in some situations even that may be excessive.

Soil type and erodibility has some effect on maximum permissible velocity. In that part of Muranga to which this paper refers there are two main soil types, the humic andosol (mainly in the tea zone) and the eutric nitosol (mainly in the coffee zone), and available evidence (Barber et. al., 1981) suggests that the former is considerably more erodible than the latter. Lower values for maximum permissible velocity should therefore apply to the andosols.

3.5. Availability of Capital

Money is usually short and where possible waterway designs should not involve expensive structures. Although stone lining or drop structures may sometimes be needed the use of cement and concrete is usually out of the question.

4. ALTERNATIVE SOLUTIONS

The following solutions are considered:

- i) Grass lined waterways
- ii) Partly stone lined waterways
- iii) Fully stone lined waterways

It is assumed for the purpose of discussion that a 2 m top width is a practical limit. Anything narrower leads to more expensive designs and anything wider would usually be unacceptable.

4.1. Grass Lined Waterways

Assuming that the channel chape is parabolic and that the hydraulic radius, R , is approximately equal to two thirds of the depth and that the area of channel = $\frac{2dt}{3}$ where d = depth (m) and t = top width (m) (Hudson, 1971) then a graph can be drawn (fig. 1) to determine the limits to slope for various discharges depending on the depth chosen and the value used for Manning's roughness coefficient (n).

Van Dort et. al. (1974) shows a relation (from the USSCS) between the product velocity x hydraulic radius (vR) and roughness coefficient (n) for vegetation with varying

retardance classes (Fig. 2). The length of the vegetation makes a big difference to the retardance class and to the value chosen for n . Assuming however that grass is kept short a value of $n = 0.04$ would appear to be reasonable.

With $n = 0.04$, $v = 2$ m/s, $t = 2$ m and d ranging from 0.15 m to 0.45 m, the following range of values for q and s can be calculated, (Table 5), to illustrate alternative designs.

Table 5. Typical design alternatives.

| | | | |
|---------------------------------|------|------|------|
| d m. | 0.15 | 0.30 | 0.45 |
| R m. | 0.10 | 0.20 | 0.30 |
| n | 0.04 | 0.04 | 0.04 |
| v m/s | 2.0 | 2.0 | 2.0 |
| t m. | 2.0 | 2.0 | 2.0 |
| a m ² | 0.2 | 0.4 | 0.6 |
| q m ³ /s | 0.4 | 0.8 | 1.2 |
| s % | 13.8 | 5.5 | 3.2 |
| Area of catchment (approx.) ha. | 4 | 7 | 11 |

(The catchment area is calculated using the rational formula and assuming that $C = 0.4$ and $i = 100$ mm/hr.)

With the limitations imposed above it is clear that where discharge is high or slope steep, drop structures to dissipate energy will be essential. However, as drop structures add to the cost they should only be used when necessary. This is discussed further below.

4.2. Partly Stone Lined Waterway

One way of reducing waterway width is to line the central section with stone. According to Shaxson et. al.(1977), this would permit an increase in maximum permissible velocity

by only 0.3 m/s. As the value he gives for Manning's n does not differ greatly from the figure of 0.04 and as v is proportional to the square root of slope, it appears that partial stone lining would give definite advantage in terms of the maximum slope for a given discharge. The greatest benefit would be on erodible soils. It is assumed here that stone lining refers to the use of rocks, stones, hard core, etc. firmly bedded in the ground and probably held in place by rhizomatous grasses growing in-between but without the use of cement mortar or concrete.

4.3 Fully Stone Lined Waterway

For a fully stone lined waterway the maximum permissible velocity is given as 3 m/s (Shaxson et al., 1977). Again if there is no change in Manning's ' n ' the increase from 2 m/s - 3 m/s i.e. $\times 1.5$ in the maximum permissible velocity would mean an increase by $(1.5)^2 = 2.3$ in the maximum slope if other factors remain the same. It would be easier to get help for the expenditure involved where the waterway is also to be used as footpath. However there is some difficulty in assigning a correct value to the roughness coefficient. For example, Kraatz (1971) indicates n values ranging from 0.05 to 0.10 for rock lined canals.

5. SOME SPECIFIC PROBLEM SITUATIONS

There are three questions which need further consideration. Firstly, when and how should drop structures be installed, secondly, what arrangements should be made if the proposed alignment is also used as a footpath and thirdly, what should be done if a gully has already developed where a waterway is required.

5.1. Drop Structures

Drop structures are needed if the actual slope of the ground exceeds the maximum slope for a given discharge bearing in mind the limitations of top width imposed by land shortage. If for example the maximum slope for a given design is 20% but the actual ground slope is 30% then for every 100 m

length of waterway drop structures are required with a total height of 10 m, e.g. 1 m drop structures spaced 10 m apart.

Beckley (1935) gives suggestions for drop structures: one using vegetated structures (Fig. 3) and one using rock. The writer saw an example of the former established by the Ministry of Agriculture at Tuloi near Kapsabet on about 10% slope which appeared to be quite satisfactory. Beckley (1935) suggests that 20% slope would be the limit for this kind of waterway.

If rock is available locally it is obviously more suitable for drop structures. The basic principles for design of such structures as given in Shaxson et. al. (1977) and Wenner (1980) should be followed. The design suggested by Beckley (1935) is cheap but lacks proper arrangements for energy dissipation.

5.2. Foot-paths

Where a footpath is needed beside a waterway the two should be combined. It is possible to have a stone lined waterway which can be used as a footpath except during heavy storms (which are relatively infrequent). A suggested configuration is shown in Fig. 4.

5.3. Gullies

Where a gully exists already, as for example that described by Damba (1981) at Kabati, Kandara, there are two alternatives:

- a) to reshape the gully and make a waterway of uniform cross-section from top to bottom,
- b) to put drop structures in the floor of the gully and allow sedimentation to level off the intervening sections.

In choosing one or other option, a careful study of the design requirements and the costs involved is needed.

In either situation provision for a footpath is often required, otherwise people will walk alongside the existing gully and widen the area of erosion.

6. CONCLUSIONS AND RECOMMENDATIONS

- a) Drainage works such as cutoff ditches, road drains and graded terraces should not be installed until arrangements have been made to discharge the water.
- b) Natural waterways should be used wherever possible.
- c) Several small waterways are preferable to one big one.
- d) Design must be based on an estimate of discharge for which survey and measurement of catchment area are required.
- e) The value attached to the roughness coefficient (n) in Manning's equation is a major factor in determining the maximum slope for a given width, depth, permissible velocity and discharge.
- f) Due to intensive land use it must generally be assumed that grassed waterways have short grass and if v and R are constant a fixed value of n can be used in design but the value will depend on the retardance characteristics of the grass.
- g) The type of grass used should spread either by stolons or rhizomes, preferably the latter. Kikuyu grass, Paspalum notatum or star grass (especially the rhizomatous type known as Cape Royal or Madi River) would be suitable.
- h) Due to the shortage of land and its high value, waterways should be designed as narrow as possible within the limits of cost. For general purposes a maximum of 2 m width is probably reasonable.
- i) Where calculations show that slope is steeper than would be possible for a given design then drop structures, preferably of rock should be incorporated.
- j) If the waterway alignment is used as a foot path then the two can be combined if stone lining is used.

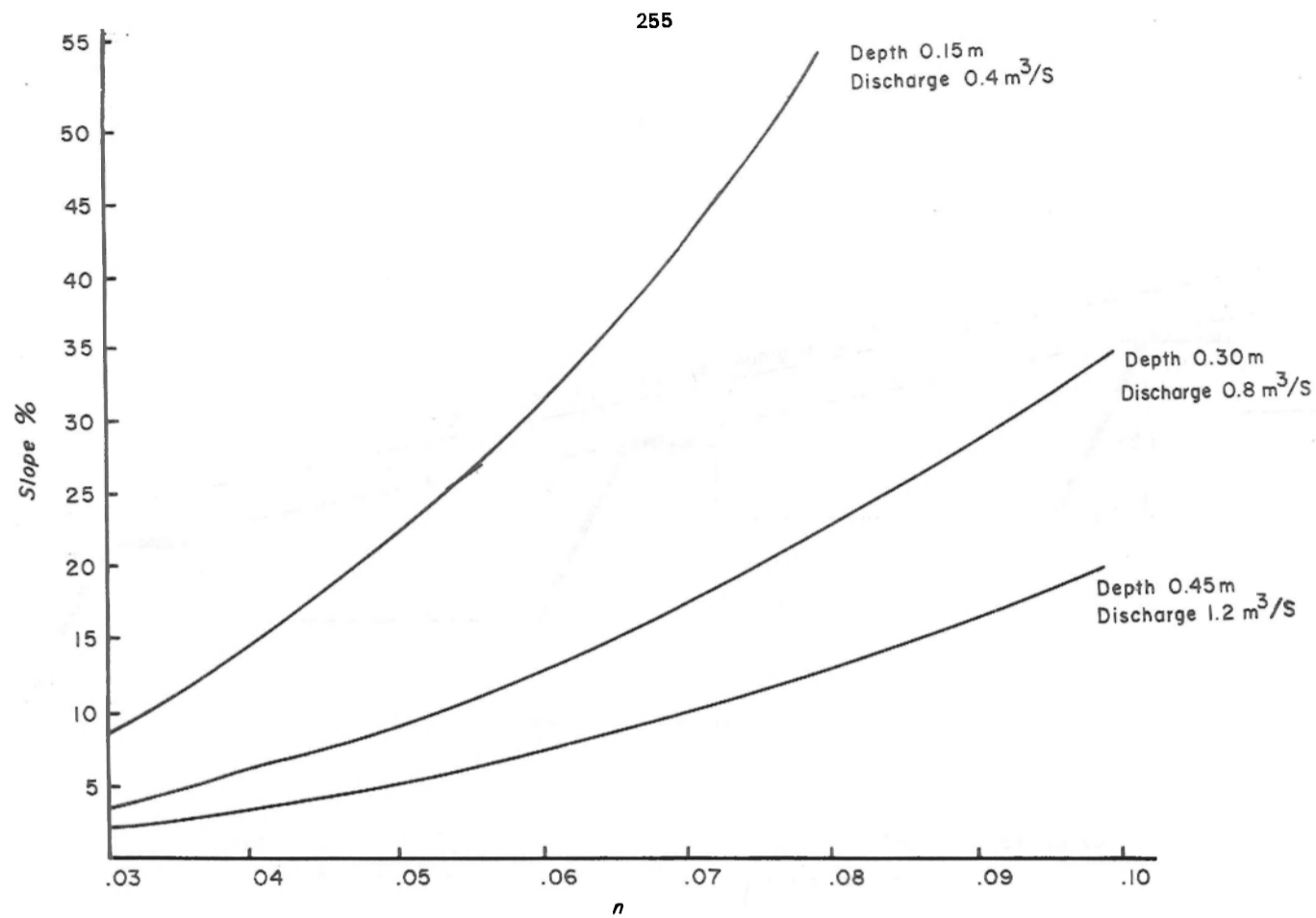

Fig.1 INFLUENCE OF MANNING'S "n" ON MAXIMUM SLOPE FOR DESIGN OF PARABOLIC GRASS WATERWAY ASSUMING MAXIMUM PERMISSIBLE VELOCITY 2m/s AND TOP WIDTH 2m

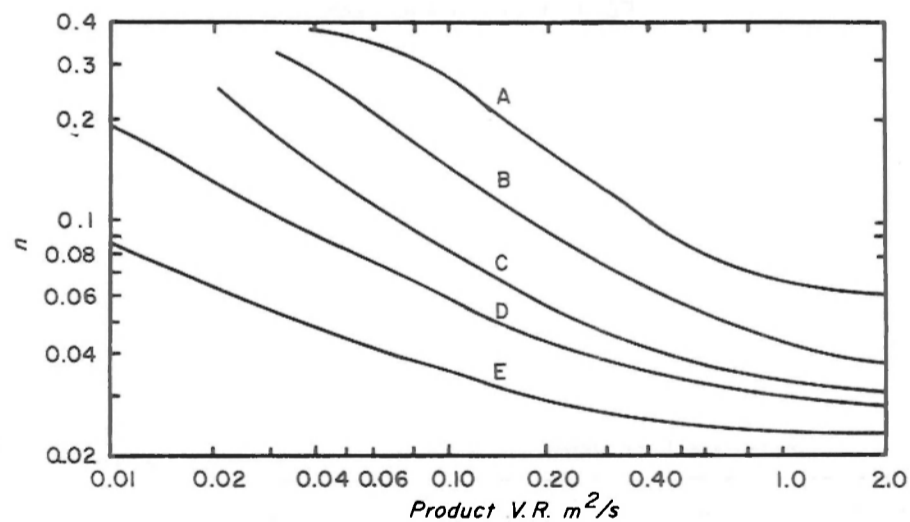

Fig. 2 BEHAVIOUR OF MANNING'S "n" IN GRASSED WATERCOURSES (from Van Dort et al 1974)

Note: The classification of grass species is based on their stalk length and vigour and thickness of growth as follows :-

| Average length of grass | Vigour and thickness | |
|-------------------------|----------------------|------|
| | Good | Fair |
| More than 0.75 m | A | B |
| 0.30 - 0.60 m | B | C |
| 0.15 - 0.25 m | C | D |
| 0.05 - 0.15 m | D | D |
| Less than 0.05 m | E | E |

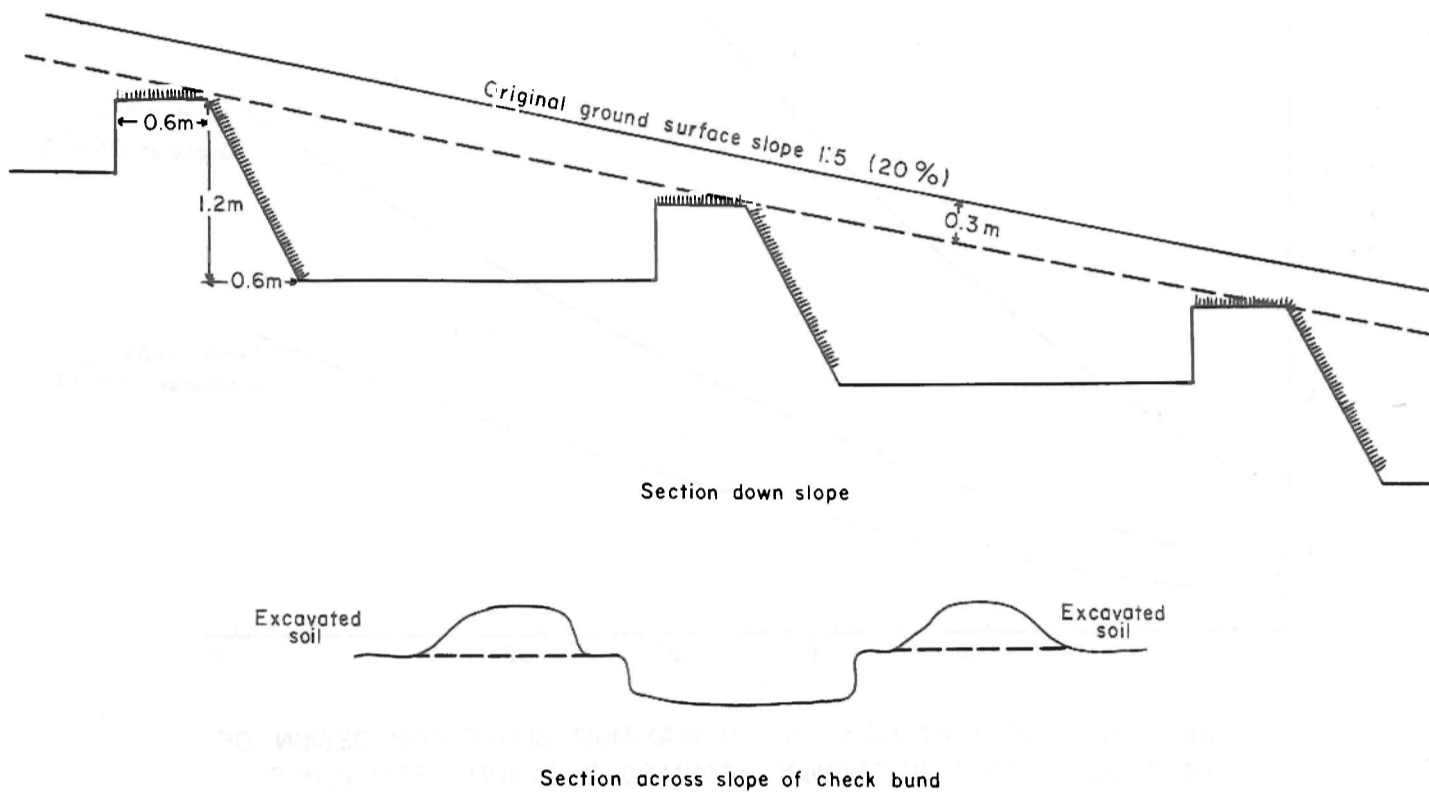

Fig. 3 STEPPED DRAIN WITH EARTH BUNDS TURFED ON TOP AND ON FALL (from Beckley 1935)

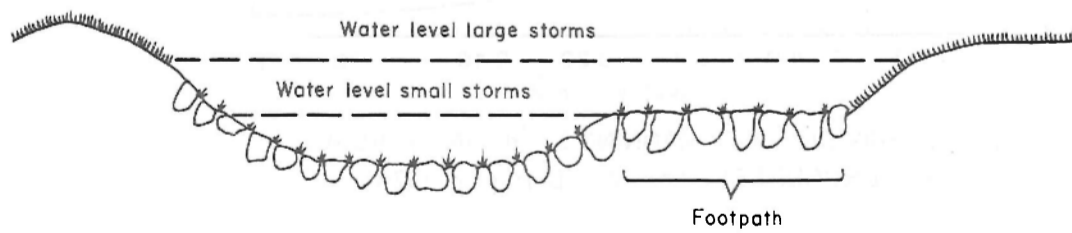

Fig. 4 SUGGESTED CONFIGURATION OF COMBINED WATERWAY AND FOOTPATH

REFERENCES

- Beckley, V.A. (1935). Soil Erosion. Department of Agriculture. Government Printer, Nairobi. 76 pp.
- Damba, J. (1981). Investigation into causes of gullying and gully control in Kandara Division of Muranga District. Project Report submitted in partial fulfilment of the requirements for the postgraduate Diploma in Irrigation/Soil Conservation. University of Nairobi.
- Elwell, H.A. (1977). Design of open channels for soil and water conservation. Department of Conservation and Extension. Salisbury, Zimbabwe. 40 pp.
- Gil, N. (1979). Watershed development with special reference to soil and water conservation. FAO Soils Bulletin 44, Section 7.3.10. Water Disposal Systems. pp.69-76.
- Hudson, N.M. (1971). Soil conservation. Batsford. Chapter 8.4. The Design of grass waterways, pp. 138-141.
- Institute of Development Studies (1978). Soil and Water Conservation in Kenya. Proceedings of a Workshop, September 1977, Occasional Paper No. 27, I.D.S. University of Nairobi.
- Kraatz, D.B. (1971). Irrigation canal lining. Irrigation and Drainage Paper No. 2. FAO, Rome.
- Mwaniki, D.M. (1980). Designing artificial waterways for disposal of runoff from farms and roads. Project Report submitted in partial fulfilment of the requirements for the postgraduate Diploma in Soil Conservation, University of Nairobi.
- Mwangi, W.M. (1982). Personal Communication.
- Republic of Kenya (1978). Rainfall Frequency Atlas of Kenya. Ministry of Water Development, Master Planning Section.
- Schwab, G.D. Frevert, R.K., Edminster, T.W. and Barnes, K.K. (1981). Soil and Water Conservation Engineering. Third Edition, Wiley.
- Shaxson, T.F., Hunter, N., Jackson, T.R. and Alder, J.R. (1977). Land Husbandry Manual: Techniques of Land-use Planning and Physical Conservation. Ministry of Agriculture and Natural Resources, Malawi, Edminster.
- Sheng, T.C. (1977). Protection of cultivated slopes, Chapter XI in Guidelines for Watershed Management. FAO, Conservation Guide No. 1 pp. 147-171.

- Sheng, T.C. (1981). The need for soil conservation structures for steep cultivated slopes in the humid tropics in Lal, R. and Russell, E.W. (Eds.). Tropical Agricultural Hydrology, Wiley, pp. 357-372.
- Thomas, D.B. (1979). Report of a visit to the U.S.A. and Mexico to study soil conservation research and practice. Department of Agricultural/Engineering. University of Nairobi. pp. 36.
- Wacira, Z.P.N. (1979). Determining Manning's n for different grasses on sloping land. Report submitted in partial fulfilment of the requirements for BSc degree in Agricultural Engineering, University of Nairobi.
- Water Development Division (1970). Computation of floods in Kenya. Mimeographed paper, Ministry of Water Development (formerly Agriculture) Nairobi.
- Wenner, C.G. (1980). Soil Conservation in Kenya. Ministry of Agriculture, Nairobi.
- Barberm R.G. and Thomas, D.B. (1981). Infiltration, surface runoff and soil loss from high intensity simulated rainfall in Kenya. Research Report to FAO.
- Van Dort, J. and Bos, M.G. (1974). Main drainage systems Chapter 29 in Design and Management of Drainage Systems Vo. 4. Drainage Principles and Applications, IILRI Wageningen.

EVALUATION AND ECONOMIC APPRAISAL OF SOIL CONSERVATION
IN A PILOT AREA - SUMMARISED REPORT

By

Lars Hedfors,
Soil Conservation Branch
Ministry of Agriculture

In July, 1981, the above paper was made with the primary aim of evaluating and quantifying to an extent possible, the results of actual soil conservation practice and its impact on the individual farm and society.

The area studied is located in Nandi District in the Rift Valley Province. The site is called TULOI, with an area of 2,200 hectares and a population of 6,600 persons, which means a density of 300 persons per sq. km. There are about 500 farm parcels, with each farm ranging from $\frac{1}{2}$ -5 hectares of arable land. Before 1951, the area was pasture land, and later was converted into agricultural or cultivated land with traditional cultivation practices. The initial harvests were good, but soon after, yield decreased markedly as a result of heavy soil erosion. The top soil, having been exposed directly to rainfall, was washed away.

In 1974-75, the area was selected by Dr. C.G. Wenner as one of the four trial areas for intensified soil conservation in Kenya, with Sweden (Through SIDA) contributing not only expertise, but also funds for education, digging of cut-off drains, bulking up of fodder grass, and purchase of tree seedlings. At present, 80% of the farmers are engaged in soil conservation practice. More than 33 km. of cut-off drains have been constructed and soil conservation crops such as fodder grass and sugar-cane have been introduced. By 1978, most of the area had been redeemed from creeping soil erosion.

In this evaluation, the analytical framework consists of comparing three hypothetical farm models with each having a

different level of soil conservation utilization.

1. Traditional cultivation without soil conservation means.
2. Present utilization now practised in the area.
3. Higher-than-present utilization, which is feasible to attain.

To provide comparability, each model was extracted from primary survey data on the results of soil conservation practice such as land use, physical soil conservation measures adopted, soil conservation crops planted, and yields. The findings and conclusions can be briefly summarized as follows:

1. The maize yields increased by 62%, out of which one half or 31% could be attributed to pure soil conservation. The other half is attributed to improved seeds, better cultivation techniques, and other improvements.
2. For beans, the increase was 43% directly attributable to soil conservation measures.
3. Increase in employment. Soil conservation measures, among others, include maintenance of the terraces and the drains, which necessitates an extra 85 man-days per year for the average farm.
4. Added income. Due to increased yields in food crops and the value of soil conservation crops planted on the terrace edge and cut-off drains, gross margins for farmers increased from 5,000 to 8,000 KShs.
5. Finally, in implementing soil conservation works, the additional labour input gives a return of KShs. 30 per day which is a return 4-5 times higher than the return of labour of a farmer not engaged in soil conservation works.

From the society's point of view, soil conservation means an increase in production. Due to the effects of soil conservation the total production of maize, beans and soil conservation crops was valued at 1.4 million KShs, or a 42%

increase above an area not practising soil conservation. Of this amount, 0.6 million KShs. is the value of increased maize production valued at border prices, which otherwise would have been imported.

All in all, there has been a public/social investment of about 350,000 KShs. during the project's implementation. The return on this sum is 1.4 million KShs. a year or four times the investment. Also, the social efforts at training and assisting the farmers served as an injection of incentives. For them to improve their farming practices. The pay back period of this social investment is less than a year.

What has been evaluated are the quantifiable results of soil conservation. A benefit of soil conservation which is not quantifiable is the preservation of soil for the future generation.

| | 1977 | 1978 | 1979 | 1980 |
|---------------------------------|-------|-------|-------|-------|
| Index | 100 | 147 | 248 | 447 |
| Gross Margin | 8.27 | 8.80 | 12.41 | 22.20 |
| Gross Margin per man-day | 0.27 | 0.30 | 0.41 | 0.70 |
| Gross Margin (B-D) | 2,320 | 2,825 | 3,180 | 3,327 |
| Total Labour Requirements | 874 | 995 | 1,089 | 1,278 |
| Total Labour | 874 | 995 | 1,089 | 1,278 |
| Soil Con. Works | - | 58 | 28 | 28 |
| Cultivation | 874 | 889 | 1,069 | 1,250 |
| Labour Requirements in man-days | 874 | 995 | 1,089 | 1,278 |
| Total Costs | 2,320 | 2,825 | 3,180 | 3,327 |
| From Crops | 105 | 105 | 110 | 110 |
| Soil Conservation | - | - | - | - |
| Food Crops | 275 | 445 | 465 | 470 |
| Variable Cost | 2,320 | 2,825 | 3,180 | 3,327 |
| Total Revenue | 2,320 | 2,825 | 3,180 | 3,327 |

Table 1. Commercial appraisal for farmers, yearly cash flow, in Shs.

| Item | Zero s.c. utilization level | Present s.c. utilization level | Higher than present utilization level | Marginal Analysis | |
|--|-----------------------------------|--------------------------------------|--|----------------------|--------------|
| | Model 1 | Model 2 | Model 3 | 2-1 | 3-1 |
| A. Production (output) | | | | | |
| Maize (in kgs) | 2,790 | 3,440 | 3,440 | 650 | 650 |
| Beans (in kgs) | 1,140 | 1,635 | 1,635 | 495 | 495 |
| Foddergrass | - | 90 | 275 | 90 | 275 |
| Sugarcane | - | 250 | 1,740 | 250 | 1,740 |
| Forest trees (Poles) | - | 10 | 160 | 10 | 160 |
| B. Revenue | | | | | |
| Maize | 3,095 | 3,820 | 3,820 | 725 | 725 |
| Beans | 2,530 | 3,630 | 3,630 | 1,100 | 1,100 |
| Foddergrass | - | 450 | 1,375 | 450 | 1,375 |
| Sugarcane | - | 375 | 2,610 | 375 | 2,610 |
| Forest trees | - | 150 | 2,400 | 150 | 2,400 |
| Total Revenue | <u>5,625</u> | <u>8,425</u> | <u>13,835</u> | <u>2,800</u> | <u>8,210</u> |
| C. Variable Costs | | | | | |
| Food Crops | 275 | 445 | 445 | 170 | 170 |
| Soil Conservation Crops | - | 105 | 210 | 105 | 210 |
| Total Costs | <u>275</u> | <u>550</u> | <u>655</u> | <u>275</u> | <u>380</u> |
| D. Labour Requirements in man-days | | | | | |
| Cultivation | 814 | 869 | 1,062 | 55 | 248 |
| Soil Con. Works | - | 26 | 26 | 26 | 26 |
| Total labour requirements | <u>814</u> | <u>895</u> | <u>1,088</u> | <u>81</u> | <u>274</u> |
| E. Gross Margin (B-C) | | | | | |
| | <u>5,350</u> | <u>7,875</u> | <u>13,180</u> | <u>2,525</u> | <u>7,830</u> |
| F. Gross Margin per man-day labour (E/D), in Shs. per day | | | | | |
| | <u>6.57</u> | <u>8.80</u> | <u>12.11</u> | <u>31.20</u> | <u>28.60</u> |
| G. Gross Margin Index | | | | | |
| | 100 | 147 | 246 | +47 | +146 |

Table 2. Social appraisal for Tuloi area yearly cash flow, in 000 Shs.

| Item | Zero s.c. utilization level | Present s.c. utilization level | Higher than present utilization level | Marginal Analysis | |
|--|-----------------------------------|--------------------------------------|--|----------------------|--------------|
| | Model 1 | Model 2 | Model 3 | 2-1 | 3-1 |
| BENEFITS | | | | | |
| A. Production (Output) | | | | | |
| Maize (tons) | 1,060 | 1,310 | 1,310 | 250 | 250 |
| Beans (tons) | 435 | 625 | 625 | 190 | 190 |
| Foddergrass (in 000 bundles) | - | 35 | 105 | 35 | 105 |
| Sugarcane (000 canes) | - | 95 | 665 | 95 | 665 |
| Forest trees (000 poles) | - | 3.8 | 61 | 3.8 | 61 |
| B. Value | | | | | |
| Maize | 2,400 | 3,000 | 3,000 | 600 | 60 |
| Beans | 970 | 1,390 | 1,390 | 420 | 420 |
| Foddergrass | - | 175 | 525 | 175 | 525 |
| Sugarcane | - | 142 | 631 | 142 | 631 |
| Forest trees | - | 57 | 915 | 57 | 915 |
| Total Value | <u>3,370</u> | <u>4,764</u> | <u>6,461</u> | <u>1,394</u> | <u>2,551</u> |
| C. Production costs | | | | | |
| Foodcrops | 105 | 170 | 170 | 65 | 65 |
| Soil Conservation Works | - | 40 | 80 | 40 | 80 |
| Total Prod. costs | <u>105</u> | <u>210</u> | <u>250</u> | <u>150</u> | <u>145</u> |
| D. Labour requirements, in 000 man-days | | | | | |
| Cultivation | 311 | 332 | 406 | 21 | 95 |
| Soil Conservation works | - | 10 | 10 | 10 | 10 |
| Total labour requirements | <u>311</u> | <u>342</u> | <u>416</u> | <u>31</u> | <u>105</u> |
| E. Public Investments | | | | | |
| in Soil conservation | | | | | |
| Cut-off drains | - | 100 | 100 | 100 | 100 |
| Technical Assistants | - | 105 | 105 | 105 | 105 |
| Training | - | 15 | 15 | 15 | 15 |
| Equipment | - | 35 | 35 | 35 | 35 |
| Others | - | 48 | 48 | 48 | 48 |
| Forest tree seedlings | - | 48 | 760 | 48 | 760 |
| Foddergrass | - | 10 | 30 | 10 | 30 |
| Total Investments | - | <u>361</u> | <u>1,093</u> | <u>361</u> | <u>1,093</u> |

Table 2. contd.

| Item | Zero s.c. utilization level | Present s.c. utilization level | Higher than present utilization level | Marginal Analysis | |
|--|-----------------------------|--------------------------------|---------------------------------------|-------------------|---------------|
| | Model 1 | Model 2 | Model 3 | 2-1 | 3-1 |
| F. Net Product Values (B-C) | <u>3,265</u> | <u>4,554</u> | <u>6,211</u> | <u>1,289</u> | <u>2,406</u> |
| G. Net Present Value of F, (Net Product Value): | | | | | |
| At 10% interest, 20 years life-span, and the following opportunity cost of farm labour | | | | | |
| 0 | (27,800)* | (38,770) | (52,880) | <u>10,970</u> | <u>25,080</u> |
| 7 Shs. per day | (9,260) | (18,390) | (28,090) | <u> 9,130</u> | <u>18,830</u> |
| 10.25 Shs. per day | (660) | (8,925) | (16,580) | <u> 8,265</u> | <u>15,920</u> |
| H. Net Present Value of F, (Net Product Value): | | | | | |
| At labour cost of 7 Shs./day 20 yrs. lifespan at interest rate of: | | | | | |
| 5% | (13,550) | (26,920) | (41,110) | <u>13,370</u> | <u>27,560</u> |
| 15% | (6,810) | (13,520) | (20,650) | <u> 5,710</u> | <u>13,840</u> |

Notes:

a/ Calculated at border prices.

* Figures in parentheses are not part of the gist of analysis, but are shown to explain the NPV calculations.

WATER CONSERVATION ACTIVITIES IN ARID AND
SEMI-ARID ZONES OF KENYA

By

M. Trojanov
Ministry of Water Development

1. OBJECTIVES

Prior to defining the objectives of the water conservation programme carried out by the Ministry of Water Development it is felt that some clarification regarding the definition of water conservation would be necessary.

In very broad terms water conservation is interpreted to mean activities, instigated and controlled by man, to accumulate water in various ways for various purposes. It is obvious that this definition covers a wide variety of activities in order to suit the purpose of a specific measure, project or development programme. In the field of water resources development these activities are designed to oppose or supplement the natural movement of water in such a manner that the total water resource is best preserved for the uses defined for it.

The main objectives of the water conservation programme in the circumstances prevailing in the arid and semi-arid zones are as follows:

- a) provision of water supply for human beings and livestock through the regulation of surface flows in the upper reaches of a river system, regulation of subsurface flows in sandy river beds and collection of run-off water from rocky hillsides.
- b) increase of the general surface and subsurface storage of water through the retention of run-off water at suitable sites and increase of the periods of spring and source flows in water courses through the retention of water in the upper reaches.
- c) reduction of the incidence of soil erosion by regulating the volume and velocity of the transporting water agent.

d) improvement of the water quality control of river systems by reducing soil erosion.

Of these main purposes for conserving water it is obvious that the first, supply of water to human beings and livestock, will have a first priority and the greatest initial impact. The other purposes will be fully achieved when a series of water conservation programmes have been put into effect supplemented by other inputs.

The primary objective is therefore to conserve water in such places and manners that the greatest benefit can be immediately available in the form of simple water supplies to human beings and livestock. The continued practice of water conservation together with supplementary programmes will produce greater benefits at much later stage.

2. RELATION BETWEEN WATER AND SOIL CONSERVATION

Soil conservation is, amongst other methods a direct method of water conservation in the fields where the surface runoff velocities are reduced by the creation of flatter slopes, terraces and obstacles such as grass cover, contour ploughing etc. The result will be reduced run-off to the river channels, reduced flashfloods, increased flow duration and above all the reduction of soil erosion. This simplified definition clearly indicates that in the upper parts of a catchment the soil and water conservation can not be separated. Even small structures in the gullies and the smaller streams in the upper catchment can not be considered as pure water conservation structures.

The life of the reservoirs constructed further downstream as part of the water conservation programme largely depends on the soil conservation in the catchment. Without proper protection of the catchment which includes erosion preventive measures, reforestation, proper livestock management, cultivation and irrigation methods, the reservoirs will be silted up in a very short time. Taking into consideration the high capital cost for construction of a dam and its importance as a source for water supply in the arid and semi-arid

zones, the necessity for catchment protection hardly needs to be emphasised.

3. WATER CONSERVATION STRUCTURES

The water conservation activities aim at having a systematic catchment development from the upper reaches down to the lower bigger streams. The major rivers are excluded from the programme in view of the large capital investment and the complexity of the works. Large reservoirs are normally built for a multi-purpose use and are part of the regional or the national development programmes.

Starting high up in the catchment area and proceeding downstream the following structures are proposed:

Heaped Stone Weirs

These are constructed in small gullies and depressions where no real streambed has been formed by the runoff. Their function is to reduce the runoff velocities by acting as brakes. They should be up to one meter high and made of hand packed stones and boulders found in the near vicinity. Gabions can also be used for the purpose.

The construction of heaped stone weirs will mainly be on slopes over 5% where velocities higher than 2.5 m/s occur. The distance between the weirs decreases with the increase of the slope.

Masonry or Gabion Check Weirs

These structures are constructed on steep sloping gullies where the streambeds are still relatively small. Their function is to prevent further erosion and preserve the existing levels by reducing velocities. The weirs are constructed out of masonry or gabions. The foundations can be very shallow, depending on the nature of the soil. Wing walls into both banks prevent by-passing and destruction of the weirs.

It is a normal practice to site check weirs of this type so that there is no fall between the toe of the upstream weir and the sill of the one downstream. This arrangement determines the distance between the structures as function of the gulley slope. Normally the check weirs are not constructed as water retaining structures but if a ramp of cohesive soil is placed against the upstream face, some water will be retained behind the weir. Creation of such wet patches along the stream will encourage growth of vegetation thus stabilizing the side slopes and reducing sheet erosion. Where natural rock outcrops in the stream the weirs can be constructed of concrete incorporating the rock providing it is in sound condition.

Rock Catchments

Where bare rocky hill sides prevail in the catchment masonry or concrete weirs can be constructed at suitable sites in the valley creating a storage for domestic use. The size of the catchment area can be increased by constructing masonry walls of 25-30 cm high winging out on the rocky slopes in order to guide the runoff into the reservoir. The storage normally is in the range of 500-5000 cu.m and the quality of the water in most of the cases is quite good due to the rocky surface free of soil and vegetation cover. The rock catchment weirs are provided with a draw-off pipe leading to a domestic point.

Masonry or Concrete Storage Weirs

These structures are similar to the weirs constructed for the rock catchments. They can be built on streams with well preserved catchments where the sand and siltload is relatively insignificant. The construction should preferably be on solid rock or compacted cohesive soil as otherwise percolation and seepage will be a costly loss out of the small reservoir. The weirs are provided with a draw-off pipe and scour at the bottom in order to flush out the sand with the first floods. The quality of the water can be improved by filtration through sand. Simple maintenance of the pipework is required.

Subsurface Dams

Subsurface dams are masonry or concrete weirs, constructed in sandy river beds, where either the created reservoir is expected to be filled up with sand in a short time or the wall is constructed right away in the sand. These weirs are constructed on solid rock in order to avoid losses through seepage. Suitable sites for their construction are often indicated by wet patches in the sandy rivers where natural impervious rock sills occur in the river bed.

The storage capacity usually varies in the range of 200-5000 cu.m. water representing 20-25% of the volume of the sand deposits upstream the weir. Larger quantities of water can be stored with subsurface dams on wide sandy river beds. At convenient places such dams can be combined with drifts for the rural road network.

Basically there are two ways for abstraction of water from subsurface dams. Where the topography allows one or more perforated pipes bedded in graded filters are laid on the reservoir bottom. These pipes are connected to unperforated pipe crossing the wall at the lowest point in order to drain the water from the sand to the point of intake. At a suitable place downstream a domestic point and a cattle trough are constructed.

The other method is by sinking a shallow well in the sand provided with a hand pump or other device for lifting the water. The well should be constructed in such a manner and place that its cover will remain above the high water mark during the flood flows. The well can be connected to a domestic point and a cattle trough located downstream or on the river banks.

The advantages of this type of structure are the good quality of water and the negligible water losses.

Dams

Dams are major water conservation structures built in the hilly lowlands and the foothills of the mountains, where the

topography is suitable. The dam embankment can be constructed of compacted earth, combination of earth and rockfill, masonry or concrete. In the arid and semi-arid zones of Kenya most of the dams are of earthfill type.

Each dam has an adequate spillway for conveyance of the flood flow and prevention of the embankment from overtopping. Draw-off facilities are provided in order to prevent pollution of the reservoir and to improve the quality of the water. The storage varies subject to the size of the catchment and the topography of the valley in the range of 20,000 cu.m - 250,000 cu.m.

Pans (Tanks, Hafir Tanks)

The pans are relatively expensive structures due to the unfavourable ratio between storage capacity and earth moved, therefore they are constructed in areas where none of the other structures is feasible.

They are built by excavation along the drainage way or in a depression. The water is diverted by a simple intake structure to the reservoir. In areas where the sediment load of the flood flow is substantial, a silt/sand trap is provided on the intake channel.

The excavated material is usually used in a wall surrounding the tank. A stone paved sloping cattle ramp is provided as an access for the livestock to the water. The draw-off facility for domestic use consists of an infiltration gallery and a shallow well equipped with a handpump.

The depth of the pans should be at least 4 metres as otherwise the construction becomes more uneconomical in view of the infiltration losses and the high losses due to evaporation in the arid zones. Where the bottom of the reservoir lies on a pervious stratum a clay blanket is recommended in order to reduce infiltration losses. The storage capacity varies in the range of 5000-80,000 cu.m.

4. IMPLEMENTATION OF THE WATER CONSERVATION PROGRAMME

The implementation of the water conservation programme is co-ordinated by the Agricultural Services Division in the Ministry of Water Development. The large scale planning is prepared at the Headquarters in co-operation with the District Development Committees and the District Administration. At the present stage the following districts are covered by the programme : Samburu, Laikipia, Baringo, Machakos, Kitui, part of Kericho.

Under the Range Livestock Programme water conservation structures have been built as primary sources for water supply in Isiolo, Wajir and Mandera districts.

As part of the Ranch Development Programme water conservation activities are going on in Kajiado, Narok, Kwale, Baringo, Tana River and Lamu districts.

In view of the limited manpower and funds the programme does not cover the whole of the arid and semi-arid zones. But there are plans to expand the activities to Marsabit, West Pokot and Turkana districts. The construction is carried out either by direct labour units or by contractors.

There are five dam construction units operating in the country. Each unit consists of earthmoving plant, vehicles, workshop and miscellaneous small equipment. The units are engaged on construction of earth dams, pans and weirs.

The water conservation teams are smaller units involved mainly in construction of sub-surface dams, weirs, rock catchments and catchment protection measures. They are operating presently in Machakos, Kitui, and Baringo districts.

Integrated development projects such as MIDP and BPSAAP provide the opportunity for a catchment approach in the water conservation activities involving various ministries and creating a sound structure for implementation on a district level. On several dams in Machakos district comprehensive soil conservation measures have been carried out in the catchments. The first

attempt to introduce the catchment approach on a large scale will be made on Chemeron river in Baringo district. A dam has been designed at the Chemeron gorge and an extensive programme for catchment protection has been prepared. The implementation will start soon. In view of the tremendous erosion in the area this will be a very interesting project and it is hoped that a valuable experience will be gained.

Some of the small water conservation structures would be ideal for implementation by self-help or harambee groups but the experience so far has shown that the involvement of the beneficiaries from such works is rather modest. The only significant contribution from the local people has been provision of casual labour for construction. Maybe efforts should be made through the Integrated Development Programmes to involve more the rural population in the water conservation activities.

5. OPERATION AND MAINTENANCE

It is a well known fact that the proper operation and maintenance of the rural water supplies is one major problem in the rural development. Organizational and administrative constraints, training of personnel, supply of fuel and spare parts, negligence by the consumers are some of the components of this very complex issue.

The above mentioned applies to a lesser extent to the operation and maintenance of the water conservation structures, which include fencing of reservoirs in order to prevent water pollution and erosion of the banks by animals, small repairs on the cattle ramps and intakes, maintenance of simple mechanical devices like hand or wind pumps stop valves and other pipe fittings. Major maintenance works involve manual desilting of silt traps or storage reservoirs.

It is obvious that a ministry or a central body even on provincial level can not effectively take care of hundreds of small dams, pans, sub-surface dams, rock catchments and the like scattered all over the country, and very often not easily

accessible. Such primary sources for rural water supply can successfully operate only with the active community participation and support and appropriate maintenance facilities.

Here again the integrated development programmes can play a very important role in creating a working machinery on a district level for proper operation and maintenance of the water conservation structures and other rural water supply facilities. The planned maintenance unit under MIDP in Machakos district is a step in the right direction.

6. HEALTH ASPECTS OF WATER CONSERVATION

In the tropical regions where people live in close contact with stagnant bodies of water, often of seasonal nature, the incidences of water borne diseases may be extremely high. The spread of bilharzia varies with a number of factors such as climate, location, topography, soil, agricultural practices, social habits etc. Assessment of these factors in order to predict the danger of introducing the disease with the establishment of a number of man-made reservoirs is extremely difficult.

Malaria is endemic to most of the area and every effort must be made to minimise its spread and to reduce reinfection. Spreading of dysenteries as a result of the water conservation measures should also be prevented.

It is considered that earth dams and pans provide the biggest water borne disease risk, followed by rock catchments, and other storage weirs. However, a number of preventive measures of structural, chemical and social nature are known today and their applicability to the water conservation works in the rural areas deserves special attention.

All earth dams and pans should be adequately fenced to prevent all but the controlled ingress of humans and livestock to the water. All dams, pans, weirs and subsurface dams should have any water supply point removed from the site of storage as far as this is possible. Draw-off facilities with an element of

filtration of the water should be preferred to conventional draw-off arrangements.

Simple chloride dosing at the water points should be introduced first at reservoirs supplying a large number of consumers and later should be provided at all rural water supply facilities.

All water edge vegetation on dams and pans shall be constantly removed and rock catchment areas shall be kept clean of soil and vegetation likely to silt up the reservoirs or cause contamination.

Although the hazard of water borne diseases may increase with the increased number of man-made reservoirs the incidence of these diseases can be significantly reduced by introducing the above preventive measures.

7. SOCIO-ECONOMICAL ASPECTS OF WATER CONSERVATION

Since most of the water conservation activities take place in the arid and semi-arid zones of Kenya, there is a special significance in the efforts to develop the scarce water resources there. It is the policy of the Government to develop these regions in order to integrate the peoples living there in the nation and to relieve the growing population pressure in the high potential regions.

The availability of water in the arid and semi-arid areas is a prerequisite for development. Provision of adequate water supply for humans and livestock will have numerous tangible and intangible benefits, some of which will materialize at much later stage. In order of priority these benefits are : better quality and ample water supply, improved health and increased sense of well being, improved livestock management as a result of adequate watering facilities, increased carrying capacity of the semi-arid lands, reduction of soil erosion and improvement of the ecological factors, proper regional planning and development of basic infrastructure thus improving the standard of living of the local population.

During the initial stage of implementation no immediate economic benefits can be expected from the programme. The water conservation activities take place mainly in regions where the population is living in the utmost poverty. Providing these people and their livestock with water now creates the base for development with all future benefits stated above.

However, providing water facilities alone without additional inputs is not sufficient for the development of these areas. Contribution of the local communities to the construction and the operation and maintenance of the facilities is the most important input. The local people should be involved in fencing reservoirs, desilting old dams and pans, planting trees, digging of cut-off trenches etc. Participation in all these works will make the people familiar with the problems, will create a feeling of appreciation of basic maintenance and operation and will make them identify themselves with the government programme for development.

One should bear in mind that this is to a great extent an educational process and it may take some time before the rural population's attitude changes towards the desired co-operation and willingness to contribute to the development of the region and the country.

ATHI RIVER SEDIMENT YIELDS AND SIGNIFICANCE
FOR WATER RESOURCES DEVELOPMENTS

By

A. S. Wain
Tana and Athi Rivers Development
Authority

INTRODUCTION

Ultimate development of the Athi basin's water resources depends on provision of at least two large storage reservoirs. Hydrological monitoring in 1980 and 1981 has indicated that water resources of the upper basin, on volcanic rocks, may be developed by provision of storage without the risk of high rates of sediment deposition. However, sediment transport from basement rocks in the middle reaches of the river appears to be very much greater, and unless soil erosion is arrested the potential of the river's water resources may not be realized.

The Athi river basin comprises some 38,000 square kilometres of south east Kenya. The basin supports a population of over 2 million persons, including the capital Nairobi and densely populated districts of Kiambu and Machakos. The port of Mombasa and the coast north to Malindi lie outside the basin but rely on water supplies imported from it. In sustained drought conditions, Mzima springs and Sabaki river abstractions may meet the demand of Mombasa until the mid 1980's. This illustrates that the firm flow of the river system is already wholly committed, and that there is no reliable surplus flow to support new developments.

In order to raise the firm flow of the river system to support new irrigation, public water supply and hydro-power developments, large-scale storage is a precondition. Many dam sites are available along the river from Athi River town to Baricho also on two important tributaries, the Thwake and Tsavo.

One of many factors given consideration in the development strategy for the Athi river relates to current and future rates of sediment transport as sediment deposition in reservoirs reduces live storage volume and therefore yield. Reservoir developments must therefore go hand in hand with catchment rehabilitation and soil conservation measures.

During 1980 and 1981, the Hydrology Section of Ministry of Water Development intensified hydrological monitoring of the Athi river at a limited number of key gauging stations near potential storage sites, the two most important of which are known as Munyu and Mavindini. Their locations are indicated in Figure 1.

The methodology of deriving preliminary estimates of suspended sediment yields for these sites is outlined below.

METHODOLOGY

A summary of data which became available in 1980 and 1981 is given in Table 1, which illustrates that both stations might be calibrated in terms of stage-discharge and discharge-sediment relationships with considerable confidence. Gauging teams were resident at both sites during all of the major flood events of May 1980 and April and May 1981. Permanently installed cableways have facilitated both current meter gauging and depth-integrated and fixed-point sediment sampling at up to twenty and four verticals respectively across the river.

Sediment concentrations have been weighted by gauged discharge appropriate to each sampling vertical, in order to determine sediment loads for the discharge at time of sampling. Figure 2 and 3.

At Munyu, a sediment rating was derived by the method of least squares.

At Mavindini, the derivation of a sediment rating is less straightforward. Monitoring has consistently indicated that sediment loads which originate from the Thwake river basin draining

basement rocks of the Machakos hills are very much greater than those derived from the Athi basin above Fourteen Falls and Munyu, where soils are predominantly derived from volcanic rocks. Over a long period, the Munyu basin appears to yield a greater proportion of flow to Mavindini than does the lower basin. The problem of sampling bias therefore becomes a very real issue when establishing a sediment rating for Mavindini. In November 1980, and late March/early April 1981, sampling was carried out almost daily in periods when Thwake floods dominated flows at Mavindini. To select subjectively a representative number of discharges and sediment loads which reflect the long term typical frequencies of pedigree Munyu floods, pedigree Thwake floods and hybrid floods presents a number of problems. With a larger sample data base in future, these problems may become less serious.

Owing to availability of good quality river flow records for 1980 and 1981, it has been possible to identify floods at Mavindini which have Thwake pedigree, and to establish a Thwake sediment rating. This, in conjunction with the rating for Munyu, permits two methods of deriving sediment yield at Mavindini. The first method integrates the long period flow duration curve with Munyu and Thwake ratings, to which varying weight is given according to the frequency of pedigree and hybrid Munyu and Thwake floods historically. The latter was determined by simultaneous inspection of daily river flow records at Munyu and Mavindini (TRDA, 1981).

The second method utilizes a daily flow record for the Thwake derived by subtracting mean daily flows at Munyu from Mavindini allowing for an average time lag of one day. Strictly, therefore, the derived Thwake sediment rating and flow record is for the basin between Munyu and Mavindini and not the true Thwake catchment alone. A Thwake daily flow record has been created for 1980 and 1981 accordingly and applied to the Thwake sediment rating. Thus Mavindini annual sediment loads are derived by summing those of Munyu and Thwake.

The first method has been found to exhibit certain weaknesses stemming from the Mavindini flow record being of uncertain

quality, especially since 1972. Weighting the sediment ratings to relative frequencies of flow events has caused, it is believed, too much bias to Thwake, and has not allowed conveyance of total Munyu discharge over the period of record to pass through Mavindini. The second method may currently only be applied to 1980 and 1981, as Mavindini historical flow data is of lesser quality. Long period estimates based on this method are necessarily dependent on the representativeness of this period.

Rainfalls at Machakos in 1980 (837 mm) and 1981 (973 mm) were within 10 per cent of the 1926 - 1981 annual mean (909 mm). However rainfalls in March (194 mm) and April (482 mm) 1981 had return periods for respective months of 5 and 20 years respectively.

RESULTS

Flows and suspended sediment yields for 1980 and 1981 are presented in Table 2, where comparisons may be made with 25 year means for the period 1957 - 1981. The 1980 and 1981 sediment yields for Munyu and Thwake are derived from the use of sediment ratings for each mean daily flow in each year. The Mavindini yields are simply the sum of these.

The long period yield for Munyu is based on integration of the flow duration curve and sediment rating for the 25 years stated. The long period estimated for Mavindini is derived from Munyu and Thwake estimates where the latter is based solely on 1981. It is therefore a very preliminary estimate, its main justification being that runoff was near average in 1981; a year which exhibited typical drought and flood conditions - 167 days of nil or negligible flow and flood runoff in March and April in which rainfall was well above average. The steep flow duration curve so produced may therefore reflect long period conditions reasonably. Use of the Mavindini flow duration curve, employed with Munyu and Thwake sediment ratings, gave a long period yield of 7.48 Mt/yr.

A breakdown of Munyu statistics in Table 2 is given in Table 3. Taking the 1957 - 1981 period, it may be seen that

flowless than $10 \text{ m}^3/\text{s}$ occur for more than half of the 9 131 days in the record, which produce only 11 per cent of the total flow and only one per cent of the total suspended sediment load. By contrast, flows between 100 and $1\,000 \text{ m}^3/\text{s}$ occur for only four per cent of time, but yield 39 and 63 per cent of total flow and sediment yield respectively.

Size distributions of suspended sediment load are available for a range of flood events at Munyu and Mavindini. Results are presented in Table 4 and Figure 4. Determinations for Munyu are known to be of a lesser quality than for Mavindini for a variety of reasons. The Munyu sand fraction is likely to be correct, the relative proportions of silt and clay being more suspect. Textures of four top soils believed to be representative of the Machakos hills are indicated in Figure 4.

PREVIOUS STUDIES

Prior to 1980, there appear to be no more than three publications in which estimates of sediment loads in the Athi river basin have been made.

Using sediment ratings based on sampling between years 1948 - 1965 (Dunne, 1974) and readily available flow duration curves, Edwards (1979) calculated suspended sediment yields for 41 river stations in Kenya, including the Athi at Fourteen Falls among nine in the Athi basin. The calculated yield for the Athi at Fourteen Falls was $42 \text{ t}/\text{km}^2/\text{yr}$. Dunne's rating was based on sampling of five flood events only in May 1958.

In the same publication, suspended sediment yield for the small Kalundu catchment on basement rocks near Kitui is given at $546 \text{ t}/\text{km}^2/\text{yr}$, together with sediment yields based on records of reservoir siltation on the Kalundu, and Maruba river near Machakos. Deposited sediment at Kalundu represented a yield of $733 \text{ t}/\text{km}^2/\text{yr}$, whilst at Maruba, within the Thwake basin, a yield of $1\,500 \text{ t}/\text{km}^2/\text{yr}$ was indicated. Edwards suggested that suspended and bed loads of the Maruba may have been on equal proportions. In both cases, estimates were based on the period 1958 - 1974.

Based on short-period results from the small representative and experimental Iiuni catchment in the Machakos hills, within the Thwake basin, annual total sediment yield was estimated at $535 \text{ t/km}^2/\text{yr}$ (Thomas et al, 1970). Monitoring took place in one wet season only in which rainfall was approximately one third of the annual mean. The total load recorded in the measurement period was upvalued by a factor of three in order to provide a preliminary mean annual estimate.

In 1972-1973, the Sabaki river was intensively monitored in association with engineering studies for the design of the proposed Baricho water supply scheme for Mombasa (Mansell-Moullin, 1973). The long period suspended sediment yield was estimated at 8.4 million tonnes, representing a yield of $266 \text{ t/km}^2/\text{yr}$ to Lugard's Falls.

During 1980, on the basis of limited sediment monitoring in the first six months, in which no genuinely large floods occurred, preliminary estimates of suspended sediment yield for Munyu and Mavindini were given as not less than 143 and $696 \text{ t/km}^2/\text{yr}$ respectively (TRDA, 1981). By inference therefore, Thwake's yield was estimated at not less than $1\ 366 \text{ t/km}^2/\text{yr}$. These estimates were based on the period 1957 - 1979.

DISCUSSION

Although strenuous efforts have been made to obtain good quality field data over a two year period, important deficiencies should be borne in mind when considering suspended sediment yield estimates. Some of these are noted, but not fully explored, below.

Depth-integrated sampling requires that the sampler be lowered from surface to bed at an even rate, raised at an even rate, and that the collecting bottle be not full when the exercise is completed. Any deviations from this practice lead to errors in sediment concentration. In practice, errors have occurred in some samples, particularly at high stages, where the sampler had to traverse upto 14 m of water at Munyu and 6 m with velocities upto 4 m/s at Mavindini.

Sampling in three or four verticals only in rivers upto 90 m wide may lead to errors in weighted sediment concentrations.

Discontinuous sediment sampling does not permit the setting up of families of sediment rating curves for individual flood events. Whilst hysteresis looping is evident at Munyu and Mavindini in some flood events, with maximum concentration typically occurring before maximum discharge, there is to date insufficient data to allow better definition of sediment yield other than by single sediment ratings as described, and acknowledge inherent limitations (Walling, 1981).

Use of mean daily flows for entering the sediment rating underestimates sediment loads in floods when compared to using hourly discharges. For example at Munyu, during large floods centred on 13 April and 15 May 1981, hourly analyses gave loads 2.8 and 5.2 per cent greater than loads associated with the mean daily flow over 10 and 11 day periods. These errors are not large, as might have been expected, and might be compensated elsewhere.

With these sources of probable errors in mind, and in the hope that they may nearly cancel each other, Munyu and Thwake sediment yields may be compared.

The Munyu suspended sediment yield of $118 \text{ t/km}^2/\text{yr}$ suggests that soil erosion from the agricultural areas of Kiambu and the vast grazing lands of Kajiado is not as serious as in catchments of the Upper Tana basin which is also of predominantly volcanic rocks. This does not mean that there are no areas where gullying is locally a severe problem. From visual observations following bank full discharges in 1981, the bed load component of total sediment load appears to be very small indeed.

The earlier estimate of suspended sediment yield ($42 \text{ t/km}^2/\text{yr}$) based on strictly limited sampling in 1958, may be very unreliable; taken at face value, it implies more than a two-fold increase in sediment transport in the Munyu basin over the last twenty years.

Thwake suspended sediment yield, preliminarily set at $1\ 265\ \text{t}/\text{km}^2$, is derived from basement areas from Fourteen Falls to Mavindini. This indicative yield is over 1 000 per cent greater than Munyu yield and considerably greater than suspended sediment yields estimated for Kalundu, Maruba and Iiuni. The disparities are serious, for they ultimately suggest that either the Thwake estimate is too high or that previous estimates are dubious or no longer typical of catchment conditions of the early 1980s. Five observations suggest the latter.

Visits to Maruba and Iiuni suggest visually that sediment transport from Iiuni must be at least as great as from Maruba and not less. Secondly, weighted combination of Munyu and Thwake ratings provides a yield greater than that adopted for Mavindini, which is more readily supported by estimates for the Sabaki river. Thirdly, Mavindini flow records suggest that runoff as a proportion of rainfall has been increasing in the last 10 years and that mean annual Thwake runoff may now be an underestimate. Fourthly, an estimate reported in excess of $4\ 000\ \text{m}^3/\text{s}$ for the 1951 flood on the Thwake river itself (Mansell-Moullin, 1973), coupled with knowledge that typically the river does not flow for between five and six months each year, lends support to the steepness of the flow duration curve for 1981 and the sediment load of that year being taken as indicative of a long period estimate for present land use conditions. Lastly, the exponent in the Thwake sediment rating (Figure 3) appears conservative for this area when compared to the mean of 1.7 for 97 stations in Kenya, within the range 1.0 to 2.5 (Dunne, 1974). For these reasons, suspended sediment yield of $1\ 265\ \text{t}/\text{km}^2/\text{yr}$ may be considered as a preliminary and minimum estimate for the Thwake.

Suspended sediment at Munyu and Mavindini are distinctly different in their particle size compositions. Munyu basin floods transport small quantities of sand, and relatively large quantities of silt and clay, the bulk of silt being in the coarse silt range.

At Mavindini, a wide range in proportions of sand, silt and clay is evident, owing to conveyance of pedigree Munyu and pedigree Thwake floods and some blend on the two at time of sampling. By hydrograph inspection, floods of varying pedigree have been identified (Figure 4), and it would appear that the proportion of silt-sized sediment may be broadly indicative of the source area. For flood flows at Mavindini comprising less than 20-23 per cent silt, floods and sediment are predominantly derived from basement-derived soils below Fourteen Falls and in the Thwake basin. Flood flows with greater silt proportions are predominantly from the volcanic Munyu basin. This observation may appear curious as it might have been expected that proportion of sand would be a superior indicator of flood source. This does not appear to be so owing to the nature of the Athi river bed between Fourteen Falls and the Thwake confluence at Mavindini. This channel stores coarser particles of transiently deposited sediment load from streams draining the eastern parts of Kanzalu and Katulani hills. The river reach is some 130 km long and may contain approximately 6.5 million tonnes in the first metre depth of its sand bed. All Munyu floods pass through this reach and this is likely to explain the wide divergence in proportions of sand in Munyu dominant floods at Mavindini.

The long period average suspended sediment yields at once indicate the dangers in developing storage on the Thwake or Athi river downstream of Mavindini. Storage and hence dam embankment sizing would have to accommodate a very large allowance for deposited sediment. Secondary benefits might accrue by way of alleviating sediment problems at water supply abstractions, Malindi beaches and in the coral reef, but these would be unlikely to offset the cost of civil works in allowing for a large volume of sacrificial storage in any multi-purpose reservoir development. Fortunately, for a decade or so at least, there are no pressing reasons for developing storage in the middle or lower reaches of the Athi, as more attractive sites lie upstream in the basin of predominantly volcanic rocks. At Munyu, the suspended sediment yield of 0.66 million tonnes needs to be seen in the context of gross storage development in the order of 625 Mm³. Allowing for deposition of suspended and bed loads, and subsequent compaction, the annual loss of storage would be likely to be under 1 Mm³.

CONCLUSIONS

On the hydrological evidence available, it would appear that suspended sediment yields are increasing in both Munyu and Mavindini basins of the Athi river, and that yield from the basement areas of Machakos is an order of magnitude greater than from the volcanics of the upper Athi basin.

Development of reservoir storage in the upper basin should not be delayed by considerations of storage lost to sediment deposition. There is nevertheless the need for areas of severe erosion to be identified and rehabilitated by appropriate measures. These areas include some which are non-agricultural, principally relating to road cuttings, other excavation sites and the means of disposal of storm runoff from roads and other paved areas.

In the longer term, in order to harness flood runoff from Machakos District when the yield of new storage on the upper Athi is fully utilized, additional storage below the Athi-Thwake confluence will be required. Present rates of sediment transport suggest that storage projects in this river reach would be found economically and financially infeasible. There does not appear to be any evidence to suggest that recent soil conservation measures in Machakos district have begun to arrest soil erosion on any significant scale. Land denudation by gullying tends to accelerate with time, and until arrested, full development of Athi basin's water resources potential would appear to be impracticable. With increased emphasis currently being given to soil conservation by several agencies, it is to be hoped that the development potential of Athi water resources may be realized. Progress in these on-going and new soil conservation programmes may be evaluated by continued hydrological monitoring and analyses.

REFERENCES

- Dunne, T., 1974, Suspended sediment data for the rivers of Kenya, Report to Kenya Government, Ministry of Water Development.
- Edwards, K.A., 1979, Regional Contrasts in Rates of Soil Erosion and their Significance with Respect to Agricultural Development in Kenya, in Lal and Greenland, Eds. Soil Physical Properties and Crop Production, in the Tropics, pp. 441-454.
- Mansell-Moullin, M., 1973, Report on the Hydrology of the Sabaki River.
- Tana River Development Authority, 1981, Athi River Basin Pre-Investment Study.
- Thomas, D.B., Edwards K.A., Barber R.G., Hogg I.G.G., 1981 Runoff, Erosion and Conservation in a Representative Basin in Machakos District, Kenya, in Lal, R. and Russell, E.W. Eds. Tropical Agricultural Hydrology, Wiley, pp. 395-417.
- Walling D.E., Webb B.W., 1981, The Reliability of Suspended Sediment Load Data, in Erosion and Sediment Transport Measurement, IAHS No. 133, pp. 117-194.

Table 1: Summary of Hydrology Monitoring of Athi River at Munyu and Mavindini in 1980 and 1981

| River Station | Discharge | | | Maximum Gauged | | Flow Gaugings No. | Sediment Samples No. |
|---------------|---------------------------|--------------------------|--------------------------|---------------------------|-------------------------------|-------------------|----------------------|
| | Mean m ³ /s | Max m ³ /s | Min m ³ /s | Flow m ³ /s | Sediment Concentration g/l | | |
| Munyu 3DA2 | 25.9 | 754 | 2.2 | 704 | 4.9 | 168 | 231 |
| Mavindini 3F2 | 38.2 | 1 379 | 1.3 | 1 056 | 15.1 | 128 | 249 |

Table 2: Summary of Hydrological Characteristics of Upper and Middle Athi Basins

| Athi Basin | Basin Area km ² | Mean Rainfall (1926-72) Mm ³ | Mean Runoff (1957-81) Mm ³ | Sediment Load (1957-81) Mt | Runoff 1980 Mm ³ | Sediment Load 1980 Mt | Runoff 1981 Mm ³ | Sediment Load 1981 Mt |
|---------------|-------------------------------|---|---|----------------------------------|--------------------------------|--------------------------|--------------------------------|--------------------------|
| | | | | | | | | |
| Munyu 3DA2 | 5 590 | 4 920 | 736 | 0.66 | 577 | 0.23 | 1 055 | 0.87 |
| Mavindini 3F2 | 10 200 | 8 600 | 1 286 | 6.49 | 800 | 1.90 | 1 607 | 0.70 |
| "Thwake" | 4 610 | 3 680 | 550 | 5.83 | 223 | 1.67 | 552 | 5.83 |

Table 3: Proportional Runoff and Suspended Sediment Yield at Munyu, 1957-1981 and 1980 and 1981

| Discharge m ³ /s | 1957 - 1981 | | | 1980 | | | 1981 | | | 1980-81 Sediment Samples No. |
|--------------------------------|-------------|-------------|------------------------|-----------|-------------|------------------------|-----------|-------------|------------------------|---------------------------------------|
| | Time % | Runoff % | Sediment Yield % | Time % | Runoff % | Sediment Yield % | Time % | Runoff % | Sediment Yield % | |
| <10 | 54 | 11 | 1 | 58 | 15 | 3 | 48 | 9 | 1 | 27 |
| 10 - 100 | 42 | 46 | 15 | 39 | 58 | 42 | 45 | 43 | 16 | 105 |
| 100 - 1000 | 4 | 39 | 63 | 3 | 27 | 55 | 7 | 48 | 83 | 99 |
| > 1000 | (0.1) | 4 | 21 | - | - | - | - | - | - | 0 |

Table 4: Summary of Particle Size Distributions of Suspended Sediment at Munyu and Mavindini

| Station | Date | Flow m ³ /s | Suspended Sediment Concentration* g/l | Particle Size | | | d ₅₀ μ | Dominant Source of Flood at Mavindini | | |
|---------------|------------------|---------------------------|--|---------------------|----------------------|--------------------|----------------------|---|----|-------------------|
| | | | | Sand (>60μ) % | Silt (60-2μ) % | Clay (<2μ) % | | | | |
| Munyu 3DA2 | 5 5 80 | 78 | 0.67 | 4 | 29 | 67 | - | (**rogue values) | | |
| | 6 5 80 | 178 | 2.33 | 6 | 41 | 53 | - | | | |
| | 7 5 80 | 269 | 1.00 | 10 | 50 | 40 | - | | | |
| | 9 5 80 | 270 | 1.01 | 3 | 37 | 60 | - | | | |
| | 9 5 81 | 220 | 1.49 | 8 | 87 | 5 | - | | | |
| | 10 5 81 | 465 | 1.34 | 8 | 88 | 4 | - | | | |
| | 11 5 81 | 115 | 0.61 | 12 | 72 | 16 | - | | | |
| | 15 5 81 | 648 | 2.13 | 66** | 29** | 5 | - | | | |
| | 16 5 81 | 451 | 0.73 | 12 | 72 | 16 | - | | | |
| | 16 5 81 | 350 | 0.66 | 18 | 75 | 7 | - | | | |
| | 19 5 81 | 155 | 0.42 | 19 | 61 | 20 | - | | | |
| | (Koma Rock) | (15 5 81) | - | (2.37) | (4) | (91) | (5) | | - | |
| | Mavindini 3F2 | 2 4 81 | 374 | 15.10 | 54 | 16 | 30 | | 73 | Thwake 0.95 |
| | | 3 4 81 | 522 | 12.02 | 34 | 23 | 43 | | 9 | Thwake 0.86 |
| | | 4 4 81 | 327 | 11.31 | 33 | 23 | 44 | | 7 | Thwake 0.69 |
| | | 6 4 81 | 119 | 3.82 | 24 | 26 | 50 | | 2 | Thwake 0.66 |
| | | 7 4 81 | 283 | 6.58 | 47 | 21 | 32 | | 50 | Mixed(Thwake0.54) |
| | | 14 4 81 | 800 | 2.82 | 39 | 31 | 30 | | 29 | Munyu 0.83 |
| | | 17 4 81 | 274 | 2.08 | 21 | 36 | 43 | | 3 | Munyu 0.88 |
| 22 4 81 | | 109 | 0.91 | 62 | 27 | 11 | 88 | Munyu 0.83 | | |
| 15 5 81 | | 442 | 2.34 | 57 | 25 | 18 | 84 | Munyu 0.84 | | |
| 16 5 81 | | 754 | 3.62 | 28 | 46 | 26 | 12 | Munyu 0.95 | | |
| 16 5 81 | | 847 | 4.36 | 46 | 22 | 32 | 40 | Munyu 0.89 | | |
| 17 5 81 | | 321 | 0.97 | 17 | 37 | 46 | 4 | Munyu 0.97 | | |

*Most Samples taken from centre of river all by depth-integrating meter

Fig. 1: Location of Major River Gauging Stations in Upper Athi Basin.

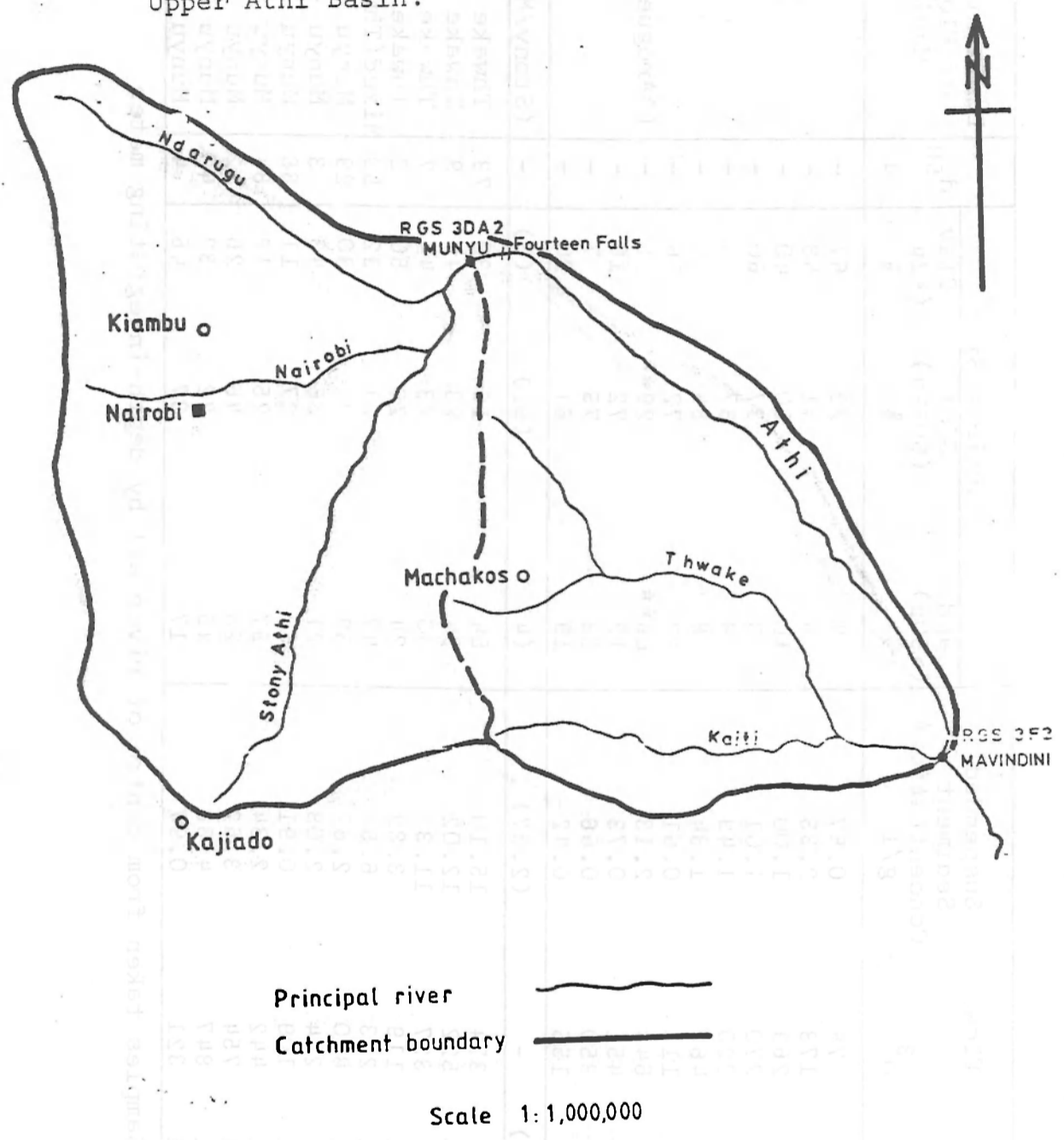

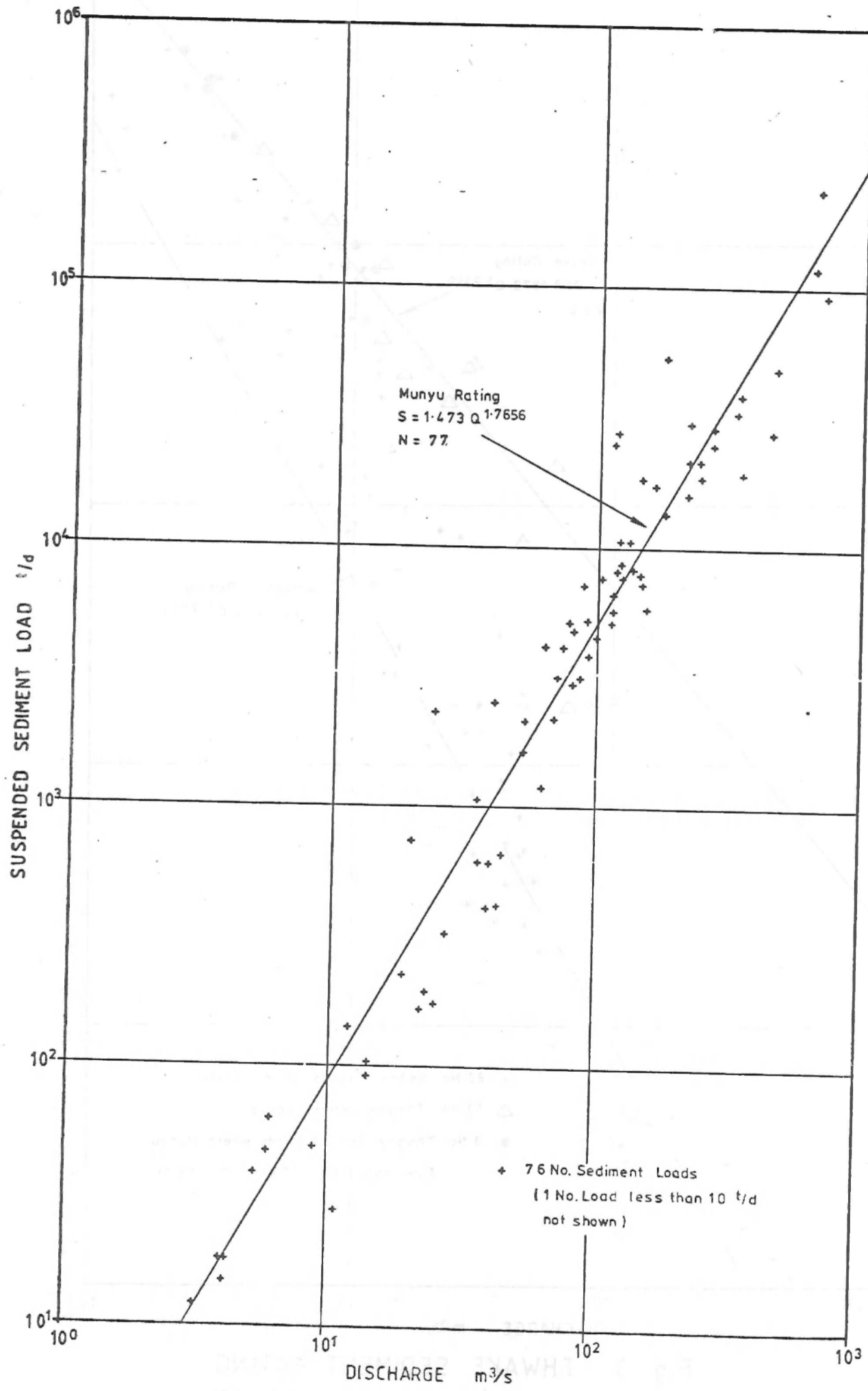

Fig. 2 MUNYU SEDIMENT RATING

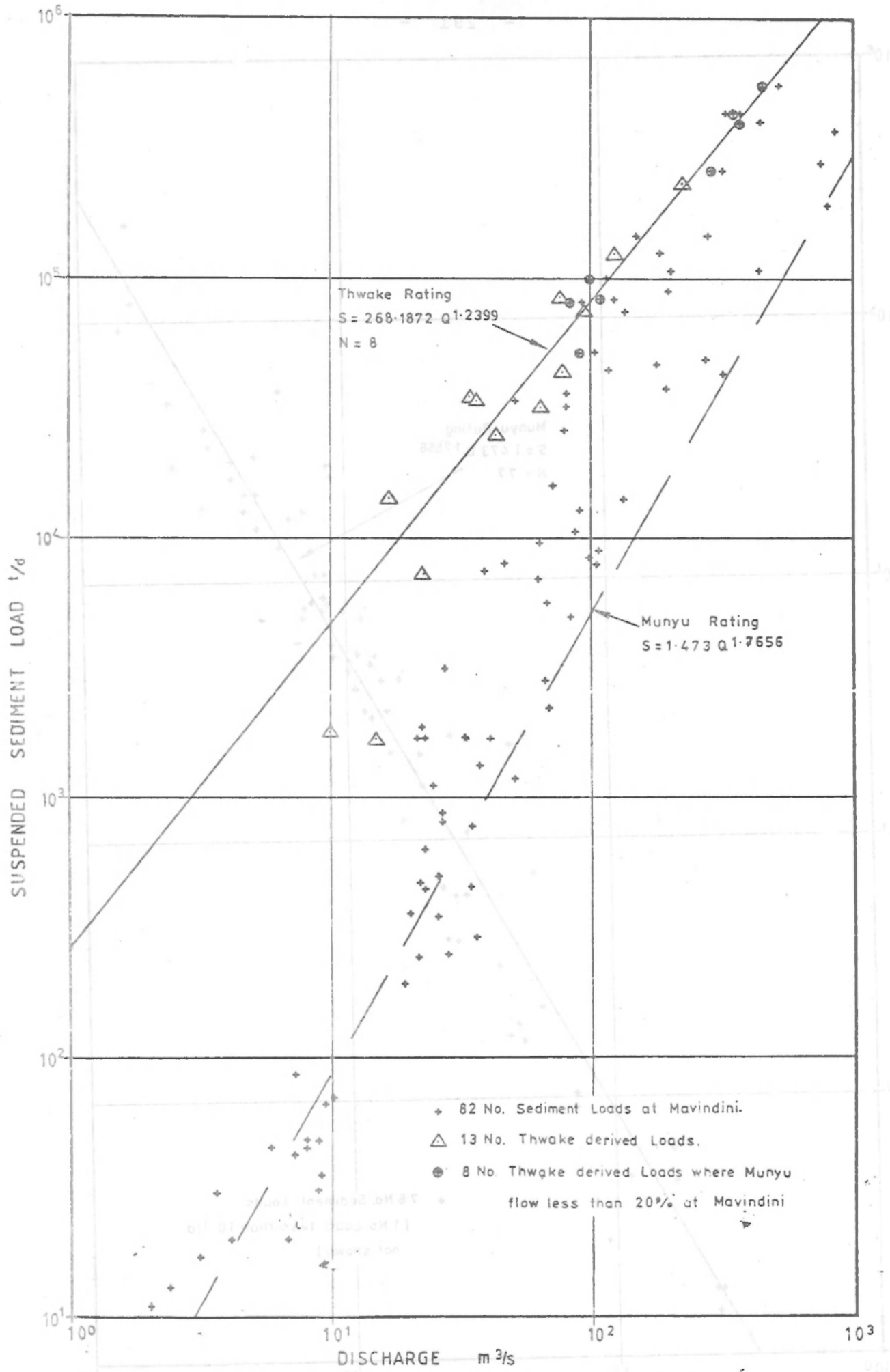
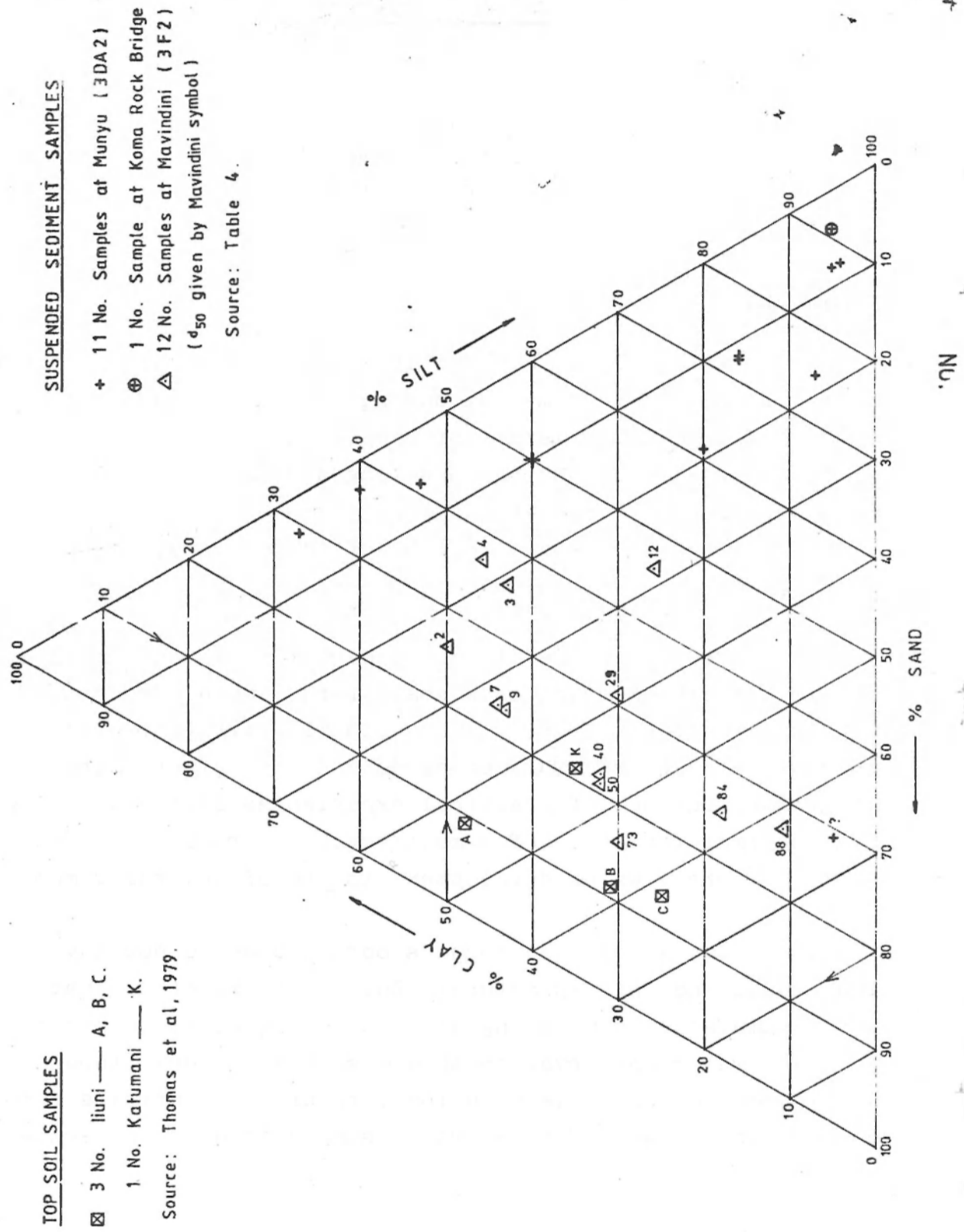

Fig. 3 THWAKE SEDIMENT RATING

Fig. 4 Suspended Sediment Particle Size Composition.



INTEGRAL FILTER SYSTEMS FOR RESERVOIRS
OF SMALL EARTH DAMS

By

Volkhard W. Werner
Machakos Integrated
Development Programme.

INTRODUCTION

Water development activities in rural areas of Kenya achieved quite some momentum during the past decades in order to reach the long range target of supplying all of Kenya's population with tapped water. During this long and costly development process a number of interim solutions will still be required, especially in the arid and semi-arid regions of the country, where suitable water resources are scarce.

The objective of this paper is to demonstrate, how simple structures, such as a small rural earth dam, can be modified to serve the population. This could be a first step on the way towards safe water. This paper does not originate out of a research programme, but out of practical experiences obtained during the ongoing implementation of a multi-sectoral rural development programme, whereby water development is one of several components.

Certainly, the results obtained up to now may be of individual and interim nature. But it is expected, that the paper will stimulate the planning and design engineers in the field of soil and water conservation to pay some additional thought to development of possible solutions, to problems arising from conventional means of rural water supply in arid and semi-arid areas.

Under the EEC financed Machakos Integrated Development Programme (MIDP) the construction of small rural earth dams has been a major component during the initial stages of the project. In order to improve the water quality of such reservoirs, tests with an integral filter system incorporated into the bottom of the

reservoir have been performed at Waiya Dam, Machakos District. First results of the performance of such a system are now available and are rather promising as shown in this paper.

WATER STORAGE BY SMALL RURAL EARTH DAMS

Water impounded by a small earth dam is generally not of a quality acceptable for human consumption. The poor raw water quality is further diminished by human and animal related contamination. The reservoirs of such dams are endangered by many water based infections, which increase the problems of using such reservoirs as a source for untreated water supply.

In most cases the storage capacity of these small dams is such that water treatment in the conventional sense cannot be justified. The installation of a small treatment plant to produce water of chemical and bacteriological acceptable properties would be too costly. Furthermore the construction of such plants would lead eventually to a multitude of mini-water projects being again too costly in terms of operation and maintenance, not to mention the logistical problems involved to keep them in proper operation, in the first place.

Under the MIDP water programme special emphasis was therefore devoted to the search for a treatment system which would use a minimum of operation and maintenance efforts. The integral filter system could offer such a solution.

THE INTEGRAL FILTER SYSTEM

The integral Filter System consists of a perforated PVC pipe of 100 mm diameter which is embedded in graded filter medium and placed at the bottom of the reservoir, see. Figure 1.

This filter package is placed in a layer of sand with a minimum thickness of 0.3 m. at the top. The whole filter system including the surrounding sand layer is wrapped by a spunbonded filter membrane to prevent eventual clogging of the filter layers.

FIG. 1 DETAILS OF FILTER SYSTEM

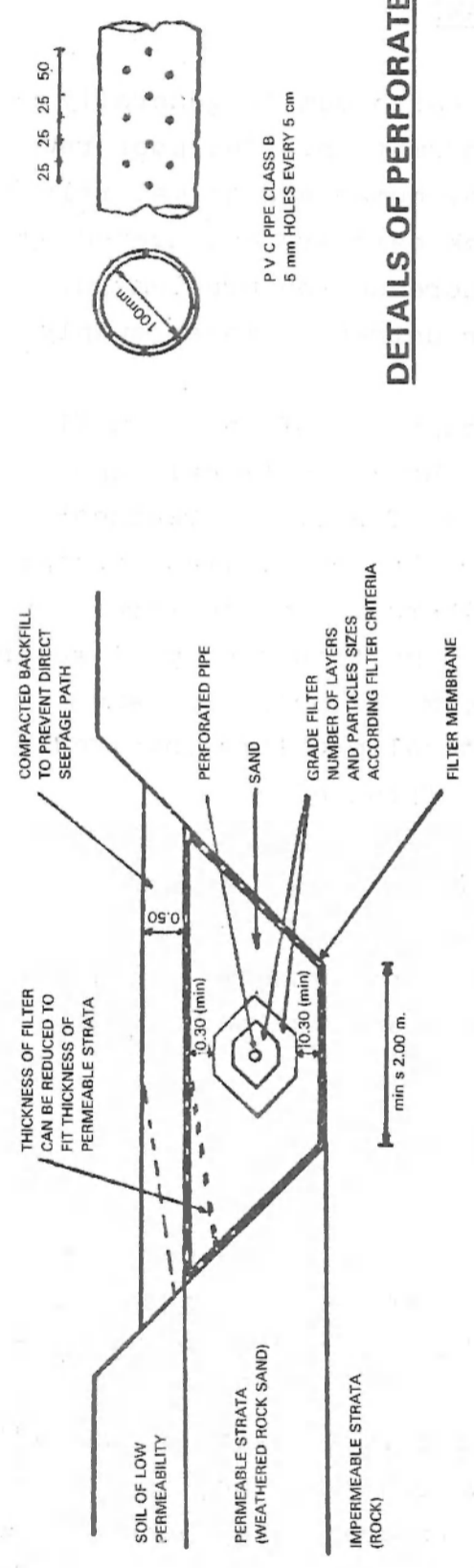

DETAILS OF PERFORATED PIPE

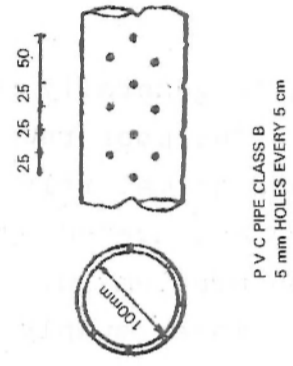

CROSS SECTION

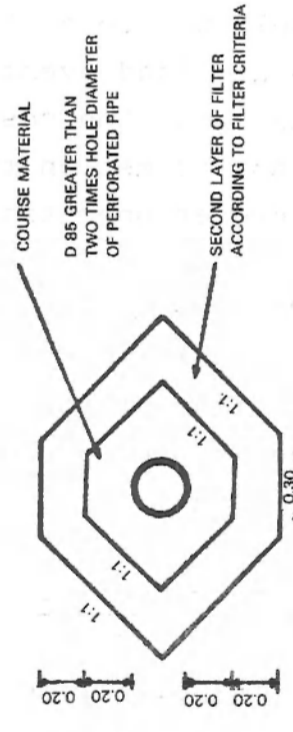

DETAIL OF FILTER

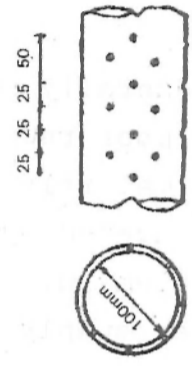

The top of the filter is covered by about 0.5 m slightly compacted backfill to prevent development of a direct seepage path into the filter. The filter is preferably placed such that the permeable strata of the reservoir are adjacent to the filter. These permeable strata are frequently found in the old river bed, its banks and in branches of the river, if any.

As the dam structure is normally located at the narrowest section of the valley, a bay type valley section is found upstream, accommodating the reservoir. Alluvial deposits of higher permeability are frequently encountered within this reach which favours the placing of the filter system.

The filter pipe is connected to a draw-off pipe which leads to the valve chamber located downstream of the dam. A public water point is connected with this valve chamber, see Figure 2. For supply of the cattle trough the conventional draw-off system should be chosen in order to save the filtered water for human consumption.

Special attention has to be paid during the placing of the draw-off pipes and the construction of the core trench of the dam, as negligence during that stage of construction could lead to eventual piping and failure of the structure.

SUB-SOIL CONDITIONS AND PERFORMANCE OF THE INTEGRAL FILTER SYSTEM

The test series on the Integral Filter System was started at Waiya Dam and is followed at Kakuyuni, Mekilingi and Muthetheni dams, which are presently under construction. The salient features of all four projects are shown in Table 1.

The subsoil conditions throughout the reservoir will be of decisive importance for the performance of the filter system. In the four cases mentioned, the sequence and thickness of strata encountered at the dam sites was sometimes quite different. At Waiya a top soil layer of 0.2 - 0.5 m is overlying red soil of 0 - 1.0 m, followed by laterite (murrum) of 0 - 1.4 m and then by highly decomposed rock of clayey silty sand composition. The

FIG. 2 GENERAL LAYOUT

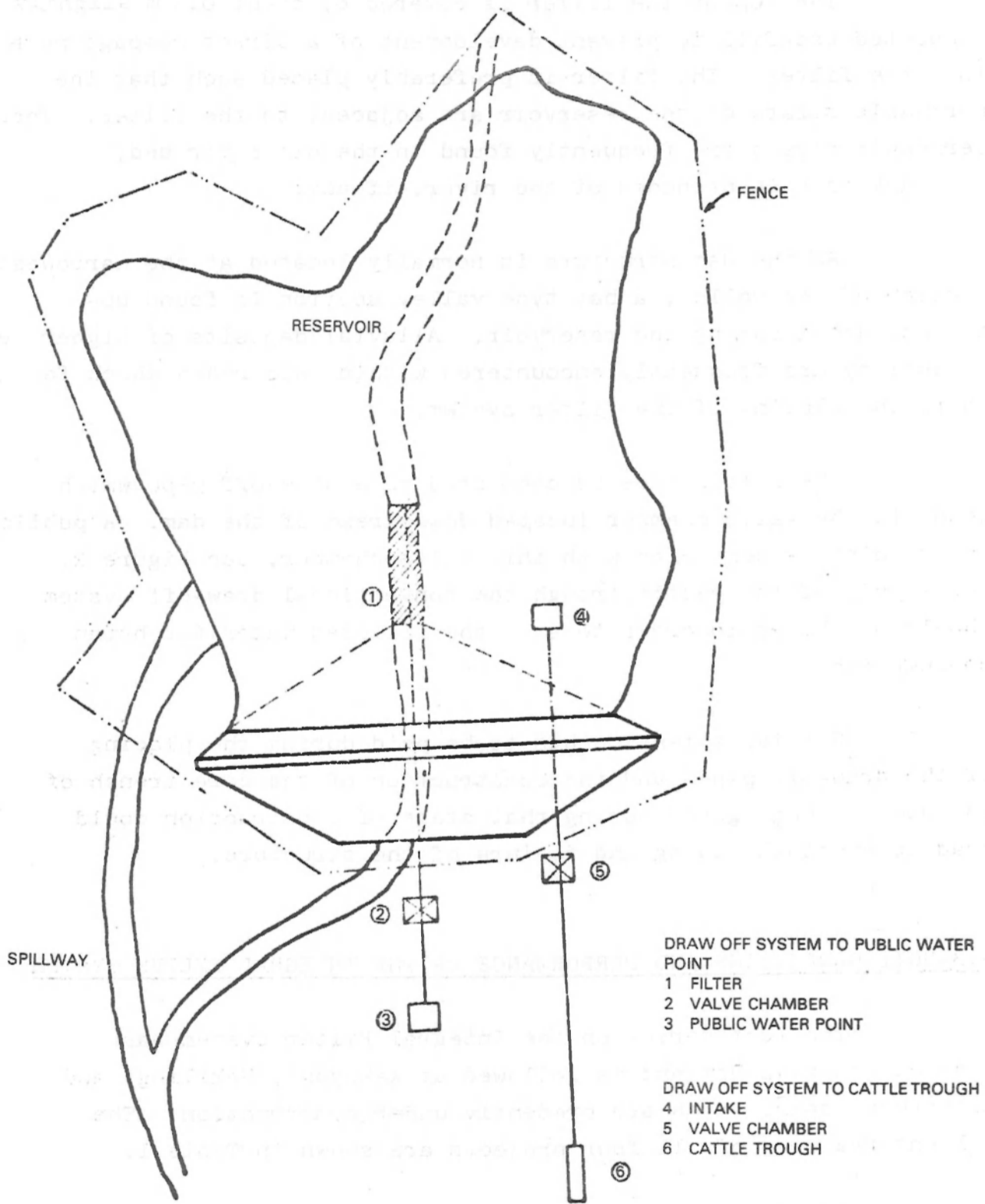

Table 1. MIDP Dams with integral filter systems

| Salient Features | | Waiya | Kakuyuni | Mekilingi | Muthetheni |
|------------------------------|-------------------|---------|----------|-----------|------------|
| Catchment Area | km ² | 2.5 | 8.3 | 12.6 | 7.3 |
| Ave. Annual Rainfall | mm | 700 | 560 | 550 | 600 |
| Ave. Annual Pot. Evaporation | mm | 1,990 | 2,030 | 2,050 | 1,990 |
| Ave. Annual Run-off | m ³ | 112,000 | 186,000 | 272,000 | 500,000 |
| Gross Storage | m ³ | 70,000 | 143,000 | 202,000 | 207,000 |
| Reservoir Area | ha | 3.8 | 6.1 | 7.6 | 9.9 |
| Dam Height | m | 8.8 | 9.5 | 12.5 | 10.6 |
| Dam Length | m | 168 | 176 | 244 | 320 |
| Embankment Vol. | m ³ | 20,000 | 23,000 | 50,000 | 55,000 |
| Spillway Capacity | m ³ /s | 25.5 | 42.1 | 49.0 | 51.0 |

left river bank is formed by alluvium of 2.4 m thickness. The river bed itself is covered by alluvium of 1.0 m. The total thickness of the strata overlying the weathered rock is in the range of 1.0 - 3.6 m.

At Mekilingi the strata encountered were top soil, red soil, laterite (murrum), black cotton soil, decomposed rock. The total thickness of these strata overlying the weathered rock is in the range of 1.2 to 2.5 m. At Muthetheni the respective range is 1.5 to 3.3 m. The encountered bed rock material was in all cases granitoid gneiss, which is predominant in the Machakos area.

The sub-soil conditions encountered at the various dam sites is likely to vary. Sample cross-sections are presently being investigated in the reservoir-areas of the three dams under construction to confirm the prevailing conditions. These results will be used to establish a first relationship between the possible amount of seepage water in the reservoir basin and the filter yield.

It is obvious, however, that not all seepage water will reach eventually the filter system. A substantial amount will percolate into deeper strata and will be lost for extraction.

Impounding of the Waiya reservoir started with the onset of the short rains in October 1981. The short rains ceased in November/December 1981 and filled the reservoir to 30% of its capacity.

First chemical water tests were performed on 2nd December 1981. Samples were taken from the reservoir and from the filtered water as well. The results are shown in Table 2.

Table 2. Test results of raw and filtered water

| Substance or Characteristic | Sample Date 2. 12. 1981 | | WHO permissible level |
|--|----------------------------|------|--------------------------|
| | R.W. | F.W. | |
| PH-Value | 6.5 | 7.9 | 6.5 - 9.2 |
| Turbidity TU | 325 | < 5 | 5 - 25 |
| Conductivity US | 62 | 680 | |
| Total Hardness mg/l CaCO ₃ | 126 | 376 | 100 - 500 |
| Iron mg/l | 0.3 | 0.6 | 0.1 - 1.0 |
| Manganese mg/l | 0.1 | 0.5 | 0.05 - 0.5 |
| Calcium mg/l | 1.3 | 114 | 75 - 200 |
| Magnesium mg/l | 3.3 | 22 | |
| Sodium mg/l | 3.8 | 58 | |
| Total Alka- linity mg/l CaCO ₃ | 12 | 174 | |
| Chloride mg/l | 2.3 | 41 | 200 - 600 |
| Fluoride mg/l | 0.4 | 0.4 | 0.7 - 1.0 |

R.W. = Raw Water,
F.W. = Filtered Water

The results clearly indicate the influence of the various strata through which the water is percolating on its path to the filter system at the bottom of the reservoir. The

question remains, whether a wash-out effect would be achieved after a longer period of operation which could result in a decrease of such parameters like PH-value, conductivity, total hardness etc. shown in Table 2.

A bacteriological test was performed on 24th February 1982, which gave satisfying results of the bacteriological treatment performance of the filter as shown in Table 3.

Table 3. Bacteriological properties of raw and filtered water

| Test | R.W. | F.W. |
|-----------------------------------|-------|------|
| Presumptive Test MPN/100 ml Water | 1800+ | 5 |
| Confirmative Test " | 1800+ | NIL |
| E. coli Test " | 25 | NIL |

MPN= Most Probable Number

According to WHO standards for the quality of drinking water the raw water is not suitable for human consumption. It contains both coliform organisms (1800+ per 100 ml of the original water) and E. coli (25 per 100 ml of the original water). The filtered water is satisfactory bacteriologically. It neither contains coliform organisms nor E. coli.

A filter yield test was performed on the same day. The initial average discharge during the first five minutes was 29 l/min. The discharge decreased to 22 l/min after two hours and remained constant at 22 l/min up to the end of the test after three hours of full opening of the filter pipe. The test results are shown in Table 4.

Table 4. Filter yield on Waiya Dam at 30% reservoirs filling

| | | | | | | | | |
|------------------------------------|----|----|----|----|----|----|-----|-----|
| Time in Minutes from Test Start | 5 | 10 | 15 | 30 | 60 | 90 | 120 | 180 |
| Average Yield in l/min | 29 | 25 | 25 | 24 | 24 | 23 | 22 | 22 |

The yield of the filter system will increase with further reservoir filling, up to the designed normal storage capacity. But a decrease has to be expected over time, when part of the reservoir will be filled by sediments of various nature. Certainly, this process will be slower than in most cases of similar reservoirs elsewhere in the country, since a substantial soil conservation programme is linked to water development activities under MIDP, thus for the Waiya catchment as well.

SOIL AND WATER CONSERVATION PLAN FOR WAIYA CATCHMENT

A concise soil and water conservation plan¹ was established already in 1980 and its implementation started immediately thereafter with substantial assistance of MIDP. A summary of the action plan is shown below.

| | |
|--|--------|
| Pasture improvement with rural afforestation | 111 ha |
| Reafforestation | 14 ha |
| Terrace improvement (slight) | 88 ha |
| Terrace improvement (major) | 33 ha |
| Total length of cut-off drains | 5.6 km |
| Total length of road drainage improvement | 4.6 km |
| No. of major gullies to reclaim | 4 |
| No. of bulking plots for trees | 1 |
| No. of bulking plots for Bana Grass | 1 |
| No. of Demonstration plots for pasture reclamation | 2 |

1. Zobisch, M.A. Concise Soil and Water Conservation Plan for Waiya Catchment, MIDP, 1980.

It is expected that the impact of these measures will increase over time reducing the siltation process of the reservoir considerably.

COST FOR CONSTRUCTION, OPERATION AND MAINTENANCE

The cost for integral filter, conventional draw-off system, public water point and cattle trough are shown in table 5.

Table 5. Cost (in 1,000 KShs) for filter, conventional draw-off public water point and cattle trough at 1981/82 prides

| Item | Project | | | |
|----------------------------------|---------|----------|-----------|------------|
| | Waiya | Kakuyuni | Mekilingi | Muthetheni |
| Filter Length (m) | 21 | 24 | 30 | 100 |
| Filter | 76 | 126 | 244 | 450 |
| Draw-off | 27 | 42 | 44 | 84 |
| Cattle Trough | 8 | 9 | 9 | 18 |
| Public Water Point | 6 | 8 | 8 | 18 |
| Total Cost | 117 | 185 | 305 | 570 |
| Total Cost in % of Project Cost | 7 | 10 | 12 | 15 |
| Filter Cost in % of Project Cost | 4 | 7 | 9 | 12 |

1 \$ US = 10.5 KShs.

The cost of the integral filter is about 3 to 6 times that of the conventional draw-off for raw water.

Operation cost for the filter will not arise in practise due to its design. The day to day operation of the small dams rests with local water committees causing no expenditures either. There could be eventually some maintenance required for the valve chamber of the filter. But this would be included in the routine maintenance of the project; the cost therefore would be very low. It would be more of a logistical problem to get the maintenance on site at the time required.

CONCLUSION

The integral filter system placed at the bottom of Waiya reservoir is producing water of substantially improved quality and appears to be a viable step towards safer water supply in arid and semi-arid areas.

Though the first results are very encouraging, there is urgent need to continue the test series to establish long term results on filter yield and treatment capacity. Further information is required on the extent and permeability of the soil and decomposed rock strata in the reservoir basin to assess the filter capacity in relation to such parameters.

THE POTENTIAL OF RUN-OFF HARVESTING FOR CROP
PRODUCTION AND RANGE REHABILITATION IN SEMI-
ARID BARINGO

By

P.D. Smith

and

W.R.S. Critchley

Baringo Pilot Semi-Arid Area Project,
Ministry of Agriculture, Marigat.

INTRODUCTION

Run-off harvesting refers to farming technique used in arid and semi-arid areas in which overland flow or flow in ephemeral water-courses is prevented from reaching major water courses and is concentrated onto an area planted with field crops, grass and/or trees. The catchment length may vary from a few metres (contour ridge run-off harvesting) to hundreds of metres (water spreading). Run-off is made to infiltrate into the soil by the use structure - usually compacted soil bunds. The net reduction in run-off which results means that not only may agricultural production be increased, or in some cases made possible, but also soil loss from the cultivated area is decreased.

For over 200 years, run-off harvesting has enabled agriculture to be practiced in areas with rainfalls as low as 100mm per year (Evanari et al., 1974). Over the last 30 years or so, population pressures have given a new impetus to improving agricultural production and reclaiming denuded rangeland in semi-arid areas. Irrigation is not always possible because of soil or topographical conditions and the current high cost of fuel and the difficulty of maintenance of irrigation systems often makes them economically unfeasible. This has led to renewed interest in the use of run-off harvesting techniques. However, most research work has been carried out in Israel, the U.S.A., and Mexico

e.g. (Shanon and Tadmor, 1976, Fogel, 1975, Medina, 1976) and other areas with Mediterranean, desert-type climates (hot, dry summers and cool, moist winters). So far, there is little published work on the applicability of the methods to tropical semi-arid areas. In Kenya some water-spreading projects were started during the 1950's, notably in Turkana, but later became disused. Interest in run-off harvesting in Turkana was renewed after the droughts of the early 1970's (Hillmann, 1980).

This paper compares the initial performance of some different methods of water concentration for crop production and rangeland rehabilitation that have recently been tried in the semi-arid part of Baringo as part of the Kenyan Government's Baringo Pilot Semi-Arid area Project.

CLIMATE AND SOILS

Average annual rainfall in the BPSAAP area is 653mm with a range of between 376 and 1087mm (24 years record). The main growing season is March to June which has a seasonal average of 267mm with a range of 128 and 498mm. For the same period, open pan evaporation is about $3\frac{1}{2}$ times the average rainfall. Mean maximum and minimum temperatures are 32.4°C and 16.6°C respectively. The variation of each is less than $\pm 1^{\circ}\text{C}$ throughout the year.

To date, water harvesting trials have been carried out mostly in the Njemps Flats area. Here, the soils are classified as Eutric Fluvisols and Calcaric Fluvisols with locally occurring saline and sodic phase (Min. of Agr., 1978). Textures are variable, but most are in the range silt loam to silty clay with silt contents up to 50%. High silt, low organic matter and occasionally rather high sodium contents cause the soils to cap very easily and high rates of run-off and soil erosion occur despite the fact that slopes are generally less than 2%. Final infiltration rates for ponded water (double ring) are in the range 60 to 70mm per hour.

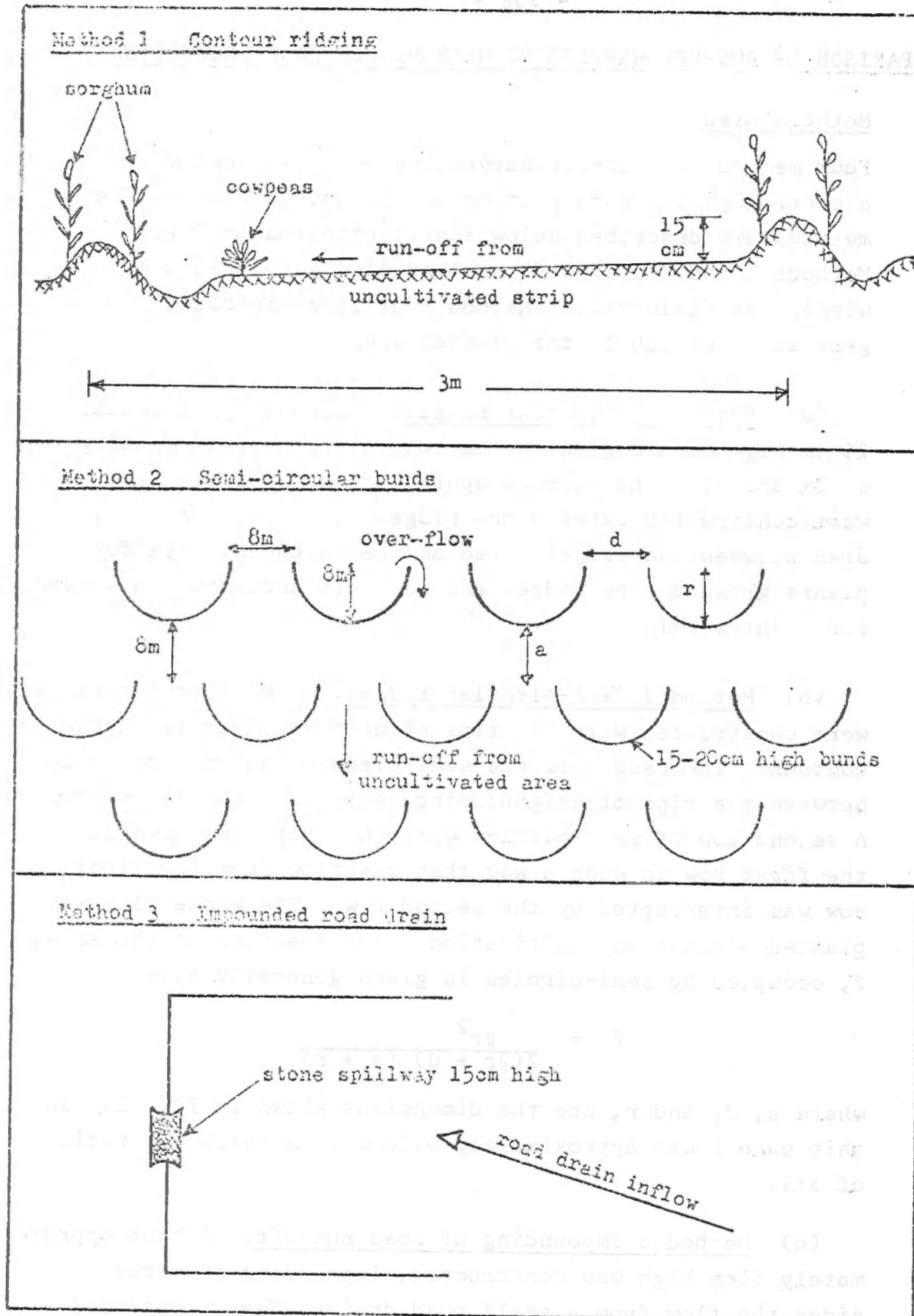

Fig.1 Run-off harvesting methods compared in observation trial

COMPARISON OF RUN-OFF HARVESTING METHODS FOR CROP PRODUCTION

(i) Methods used

Four methods of run-off harvesting were compared with a control plot. Each plot occupied about 0.08 ha. The methods are described below and illustrated in Fig. 1. Methods 1 and 2 utilised overland flow generated only within the field whilst Method 3 utilised overland flow generated outside of the planted area.

(a) Method 1 - Contour ridges. Ridges, approximately 20 cm high were dug on the contour at an average spacing of 3m and with the furrows uphill of the ridges. Ties were constructed between the ridges at 5m intervals. The area between the ridges acted as the catchment area for plants grown on the ridges and was left uncultivated except for light weeding.

(b) Method 2 Semi-circular ridges. Semi-circular ridges were constructed with the tips of each semi-circle on the contour. The radius of the semi-circles and the distance between the tips of neighbouring semi-circles was 8 metres. A second row of semi-circles was constructed 8m downhill of the first row in such a way that overflow from the first row was intercepted by the second row. The whole plot was planted without any cultivation. The fraction of the area, f, occupied by semi-circles is given generally by:-

$$f = \frac{\pi r^2}{2(2r + d)(a + r)}$$

where a, d, and r, are the dimensions shown in Fig. 1. In this case f was approximately 0.26 with a catchment ratio of 3:1.

(c) Method 3 Impounding of road run-off. A bund approximately 50cm high was constructed, impounding on three sides the flow from a small road drain. The impounded area was 0.08 ha and the catchment to plot ratio was also 3:1. A stone spillway 2m long and 15cm above original ground level was incorporated into the bund. The impounded areas was deeply dug using hand hoes.

(d) Method 4: Impounding of road run-off with zero cultivation

(e) Method 5: Control. The control plot was deeply dug using hand hoes according to local practice. A cut-off drain prevented inflow of water.

Each plot, except for Method 1 was planted with Serena sorghum at one metre inter-row, and 20cm inter-row spacing. Method 1 was planted with two lines of sorghum every 3 metres, one line on each side of the ridge. The intra-row spacing was closer giving an equivalent population density of about 50,000 plant/ha. After the first harvest, the plots were thinned to half the original density.

Pigeon peas (Local Meru) were planted at an intra-row spacing of 90cm at the same time as the sorghum. In method 1, the pigeon peas were planted on the top of the ridge mid-way between the two rows of sorghum. In Method 2, they were planted midway between alternate rows of sorghum.

After initial regrowth of the sorghum ratoon, cowpeas (Local Red) were planted at an intra-row spacing of 30cm. In Method 1, they were planted on the uphill side of each furrow and in Method 2 they were planted midway between alternate rows of sorghum. Although their positioning in relation to the row of sorghum were different, the overall populations of cowpeas and pigeon peas were the same for both Method 1 and Method 2. No harvest of pigeon peas had been obtained by the time this report was written, but the vegetative growth of pigeon peas was observed to be best in the contour ridge method.

The sorghum was planted a few days after the beginning of the rain, and the total rainfall until physiological maturity was 269mm. However a severe drought occurred after the seventh week of the growth, and continued until maturity. The rainfall which fell on the ratoon crop (from harvest of first crop to physiological maturity) was almost identical - 270mm. However there were no comparable drought periods, and with lower temperatures and more cloud cover, growing conditions were more favourable. The average rainfall over these periods for Marigat

is 202mm and 245mm respectively.

(ii) Results

A comparison of the performance of the various methods is shown in Table 1.

Despite good rainfall during the first 4 weeks, plant height measurements showed that a small advantage to water harvesting was already discernable, except in Method 4 where the zero tillage depressed early growth. Average plant heights in Method 2 were depressed for the same reason, though plants within the semi-circles (2a) did show an advantage at 4 weeks, despite signs of waterlogging earlier.

At 8 weeks and after more than one week without rain, plant height measurements showed increased advantage of the run-off harvesting methods. All plots had grown faster than the control and the best, Method 1, had grown twice as fast as the control.

The control plot almost completely failed to produce a first harvest. The only run-off harvesting method which had a poor first harvest (though still twice as productive as the control) was Method 4, in which only the area where water had concentrated produced healthy plants. Method 1, 2, and 3 all produced good crops and the best, contour ridging, produced over 7 times as much as the control. Individual plants within the semi-circles (Method 2) were best of all methods.

Ratoon harvests were generally better than the first harvest. This was primarily because at the time of the second rainy period (July/Aug) the roots were at least partially developed and could utilise the rain for vegetative growth and later grain-fill rather than in extending the root system. However, Method 1 actually produced a lower ratoon harvest. This was possibly because the crop density, although only about 2/3 of that of the other Methods overall, in the region of the ridges it was twice as dense. This may have meant that plants in Method 1 had a reduced ability to exploit the better than average rainfall during the ratoon period. Also, the

first harvest yield of Method 1 was much better than the other methods following its better establishment, and it is possible that the stem reserves were very heavily depleted during the grain-fill period of the first harvest.

The control plot, although still the poorest, ratooned well despite its initial poor performance. The great improvement in Method 2 was because of the good ratoon performance of plants outside the bunds.

The total sorghum harvest for Method 1 was over $2\frac{1}{2}$ times that of the control. Method 2 gave a yield more than 3 times and Method 3 almost 3 times that of the control.

All run-off harvesting methods produced a greater cowpea harvest than the control, with Method 1 giving the greatest yield, possibly because of the poorer sorghum ratoon making available more water for the cowpeas.

(iii) Water - concentration effect of contour ridges: A profile across a ridge showing the wetting front 2 hours after the end of a 53mm low intensity storm is shown in Fig.2. The depth of infiltration was much greater in the area around the furrow. Here all rainfall penetrated plus an extra 60% of rainfall, representing 30% run-off from each metre of catchment. Measurements of dry matter (11.5 tonnes per ha in the area around the ridge taken as 1m wide) represented evapotranspiration by the plant of 305mm (Whiteman, 1981). Whiteman also suggest an upper limit for 70% of (infiltrated) rainfall use efficiency for sorghum in semi-arid areas. Thus, the observed dry matter production would require infiltration of at least 436 mm. As the rainfall was actually 270 mm it is concluded that at least 166 mm was supplied by run-off percentage from the catchment area of at least 31% over the growing season. Rainfall use efficiencies of less than 70% would indicate higher average runoff rates.

(iv) Appraisal of methods

Despite the fact that Methods 2 and 3 gave greater overall sorghum yields, it was felt that the contour ridge system had other advantages in terms of incorporating it into an extension programme. One advantage was that this method produced the most even stand of sorghum - an important consideration where the potential for bird damage is considerable (though it was not in fact a serious problem in 1981 - possibly because sorghum had only just been introduced to the area). Another advantage of contour ridges is that their construction is over three times faster than deep digging. This should obviously make it very attractive to local farmers. The advantages in labour input/unit area and labour input/unit output is an important factor in an area where land availability is not a constraint but energy and water are. The greater harvest of cowpeas in Method 1 also partly compensated for the lower overall sorghum harvest. From the point of view of soil conservation, contour ridging means soil loss from the farm is reduced to virtually zero (Min. of Agriculture, 1981).

The provisional recommendation to farmers on land of less than 3% slope is to adopt the contour ridging system. The water distribution diagram (Fig. 2) shows that planting on each side of the furrow is preferred to planting on each side of the ridge, as was done in the trial. Where necessary, a cut-off drain is constructed to prevent the destruction of the ridges by inflow. A pilot study to look at the use of this intercepted water in an 'absorption waterway' described in the next section) is being carried out.

CULTIVATED ABSORPTION WATERWAYS

Many of the farmers within the project area who farm on flat land receive 'run-on' from small catchments above their farms. Because of the very erodible nature of the soils, severe rill and gully erosion is often caused within and below the farms despite slopes of less than 3%. The use of a cut-off drain is clearly indicated in many cases. However most farmers to whom this has been suggested complain that a cut-off drain would remove valuable extra water from their farm. A compromise

Fig. 2 Vertical profile across a ridge showing the wetting front 2 hours after cessation of a 53mm low intensity storm.

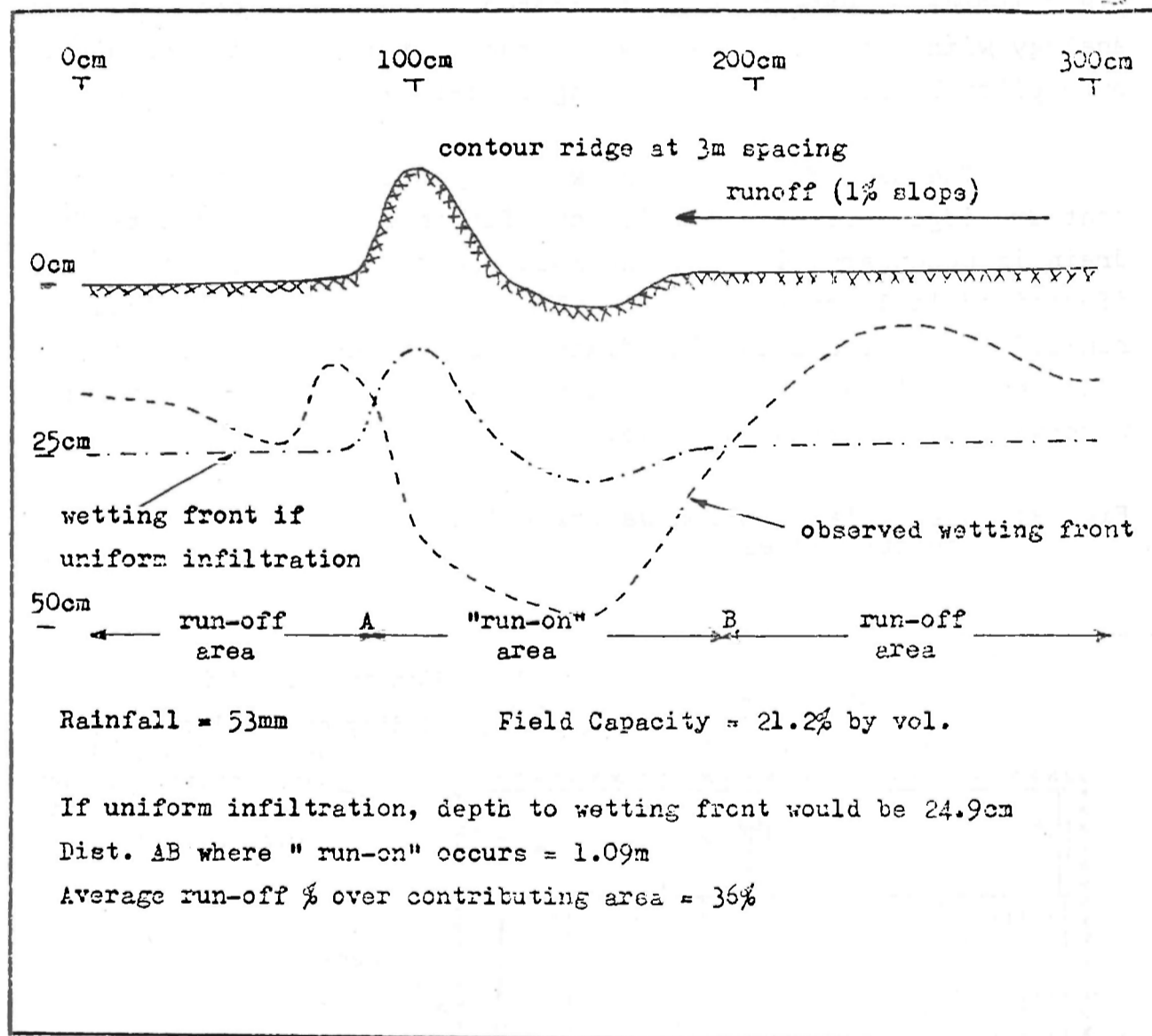

Fig. 2 Vertical profile across a ridge showing the wetting front 2 hours after cessation of a 53mm low intensity storm.

solution has been to lead the water into what is provisionally termed 'a cultivated absorption waterway'. The waterway is similar in concept to the grassed waterway of higher potential areas but is designed to absorb water by infiltration rather than simply to lead surplus water off the farm. Loose stone spillways are placed in the cross-bunds to prevent erosion and to pond water until it can infiltrate. The basins are cultivated in the same way as in Method 3 of previous section. At present it appears that farmers may not be prepared to construct the waterway themselves, though this position may change when potential yield increases have been demonstrated. Meanwhile, because of the analogy with artificial waterways, the system has been installed on a pilot basis on 30 farms using food-for-work.

The use of 'absorption waterways' in conjunction with contour ridges (see Fig. 3) is very flexible. Where no cut-off drain is necessary, it would normally be dispensed with though if desired 'collector drains' could be constructed to collect run-off from outside the immediate catchment area. Where the catchment is large, the whole farm could effectively become the waterway, as in Method 3 above.

Fig. 3: Use of 'absorption waterways' in conjunction with contour ridges.

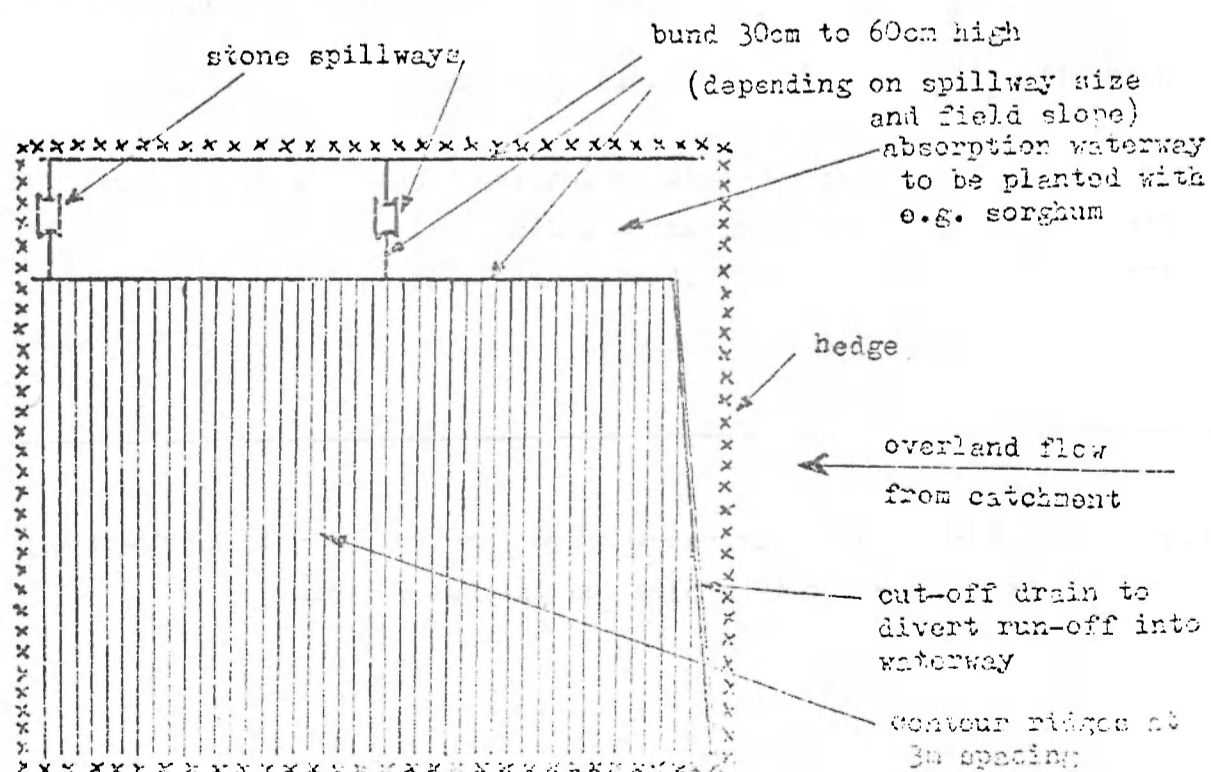

Table 1. Results of run-off harvesting trial, 1981

| Method | Serena Sorghum | | | Cowpeas | | |
|---|-------------------------------|-------------------------------|---------------------------|------------------------------|---------------------------|---------------------------|
| | Plant Ht. at 4 wks (cm) | Plant Ht. at 3 wks (cm) | 1st Harvest (kg/ha) | Ratoon Harvest (kg/ha) | Total Yield (kg/ha) | Total Yield (kg/ha) |
| 1. Contour ridges at 3m spacing | 51 | 119 | 460 | 430 | 890 | 155 |
| 2. Semi- circular bunds + zero tillage | (a) 56 | 113 | 410 | 900 | 1310 | 130 |
| | (b) 39 | 74 | - | - | - | - |
| 3. Impounded road drainage + deep tillage | 63 | 103 | 420 | 595 | 1015 | 70 |
| 4. Impounded road drainage + zero tillage | 33 | 67 | 120 | - | - | - |
| 5. Control - deep digging | 48 | 79 | 60 | 325 | 385 | 20 |

Notes 1. Sorghum hts. measured to funnel at 4 wks, top of seed head at 8 wks.

2. No ratoon harvest in Method 4 due to poor plant survival.

3. (a) and (b) in Method 2 refer to within bund and field average respectively.

The average construction time for a typical waterway is 75 man-days for a 1 ha. farm on a 1% slope.

| <u>Design Considerations</u> | |
|------------------------------|---|
| (a) Length of spillway., | The cut-off drain is designed in the usual way using Cook's and Durbach's methods (Min. of Agr. 1981). The spillways are assumed to approximate to a Missouri type flume (Schwab, 1966, p. 284) having a capacity defined by |
| | $Q = 2.1 Lh^{3/2}$ (cu.m/sec.) |
| where | h = Height of flow over the spillway (m) L = Length of spillway (m) |
| - | - Allowing a maximum depth of flow over the spillway of 25 cm, the maximum allowable flow can be approximately stated as: |
| | $Q = 0.25 L$ |
| | Catchments in the areas of lowland Baringo where runoff harvesting is feasible tend to have summed characteristics in the range of 40 - 50 (Hudson p. 112). In the range of catchment sizes we are interested in (1 to 20 ha), peak runoff (Q) can be assumed linear with catchment area (A) so that (from the table given by Hudson) |
| | $Q = \frac{A}{8}$ approximately |
| | where Q is in cu.m/sec and A is in ha. Combining the two equations gives us a 'rule of thumb' |
| | $L = \frac{A}{2}$ (m) |

which is used by locally trained field workers to decide the required length of the spillways. Different 'rules of thumb' can be obtained for different maximum flow over the spillway and different catchment characteristics to keep design criteria as simple as possible for the locally trained field workers.

(b) Ratio of catchment to cultivated area. Higher ratios will mean a smaller cultivated area and more surplus run-off.

Lower ratios lead to larger cultivated areas, with a smaller amount of supplemental water per unit area and a smaller amount of surplus run-off. It is felt that the larger cultivated area and smaller surplus run-off, associated with lower ratios, is preferable to the smaller cultivated areas and larger amounts of surplus run-off, associated with higher ratios.

(c) Vertical interval between spillway. This governs the number of basins and the uniformity of water distribution. Eventually it is expected that the basins will level out. Therefore, decreasing the V.I. of the spillways will be mainly beneficial in improving water distribution, only in the initial years. To keep costs down, a vertical interval of 0.5m has been provisionally chosen. This means that on a 1% slope, a typical farm of 1ha would have 2 spillways, 50m apart.

(d) Height of each spillway. The average depth of water that can be stored in each basin, before levelling takes place, is given by:-

$$d = \frac{h^2}{2V} \quad (\text{see Appendix})$$

where d = average depth

h = height of spillway

V = vertical interval between spillways

After levelling, the depth stored is simply equal to the height of the spillway. Together with the infiltration rate, the choice of spillway height will be governed by the susceptibility to waterlogging of the crop being grown. A maximum of 25cm has been chosen provisionally which would mean, initially, crops near spillway would be waterlogged for 5 hours, which is felt to be acceptable for sorghum after establishment. The first basin catches a lot of run-off from small showers which do not provide enough run-off to spill over

into the second basin. To make up for this, the second spillway should be higher than the first, and so on.

In order to obtain a worthwhile increase in crop production in the waterway, it was decided that the average increase in seasonal infiltration should be of the order of 200mm. The increase in seasonal infiltration is defined as the average extra amount of infiltration that occurs over the main cropping period (here defined as March to June inclusive) due to the ponding effect of the spillways. To determine the magnitude of the effect of the different factors on average increase in seasonal infiltration, the U.S., S.C.S. equation was used to predict volumes of run-off:-

$$Q = \frac{(I - 0.2S)^2}{(I + 0.8S)}$$

where Q = depth of run-off (inches)
I = rainfall depth (inches)
S = maximum potential difference between rainfall and run-off, starting at the storm's beginning (inches).

Daily rainfall records for Marigat for the past 24 years have been analysed using the equation for two of the SCS 'curve numbers' (80 and 90) felt to represent the range of conditions present in the study area. It has been assumed that only one storm occurs per rain day.

It was also assumed that there were two basins in the waterway and that there was negligible ponded water due to within field run-off when run-off from the catchment flowed in the waterway. It has also been assumed that total flow times are negligible compared with time water is ponded in the basins, but that rain which continues to fall during the passage of the flow can be absorbed. The results of the analysis are shown graphically in Fig. 4 and the main conclusions outlined below.

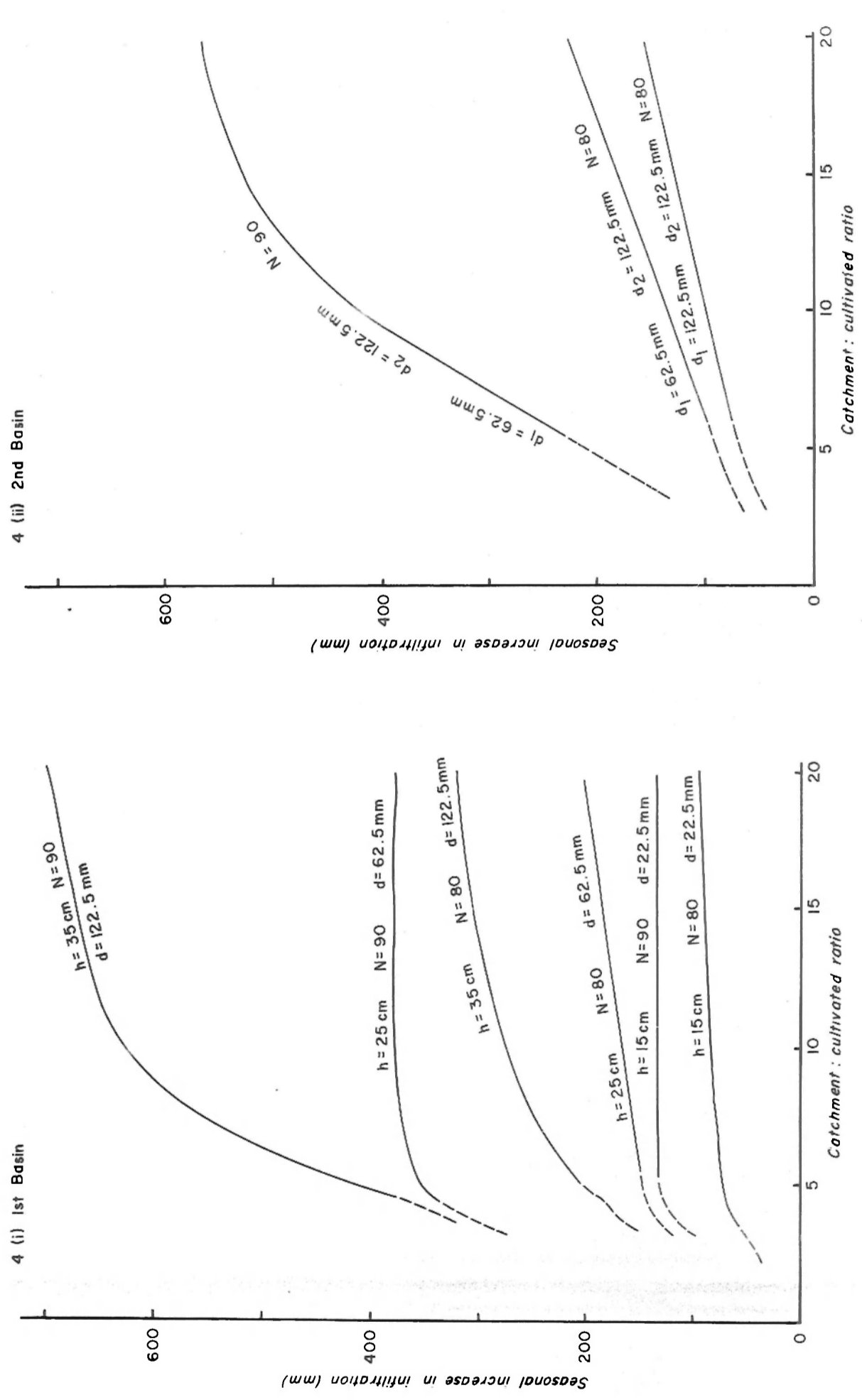

Fig. 4 SEASONAL INCREASE (March-June) IN INFILTRATION DUE TO PONDING OF RUN-OFF (mm) FOR DIFFERENT CATCHMENT CURVE NUMBERS (N), SPILLWAY HEIGHT (h), AVERAGE DEPTH OF PONDING IN FIRST BASIN (d₁), AND AVERAGE DEPTH OF PONDING IN SECOND BASIN (d₂)

(i) the effect of catchment to cultivated area ratio for the first basin is surprisingly small. The reason for this is that for ratios over 5:1, the main contribution is from the infrequent high rainfalls rather than the more frequent low rainfalls. Once there is sufficient water to fill the basin, increasing the catchments: waterway ratio adds little to the amount of infiltration.

(ii) For a curve number of 90 a catchment to waterway ratio of 5:1 is adequate if the first spillway height is 25 cm and the second spillway height is 35cm. For a curve number of 80 a ratio of 17.1 gives approximately 200mm extra infiltration in each basin. As smaller ratios mean a greater planted area and lower surpluses overflowing the second spillway, a ratio of 10:1 has been adopted until more experience can be gained of the run-off characteristics of local catchments.

Use of Water-harvesting in Range Rehabilitation

Pratt (1964) has already shown that some form of water retaining structures are necessary to rehabilitate dry alluvial sites in Baringo. However, it was felt that simpler and cheaper methods needed to be found.

An observation plot was established to compare various methods of rehabilitation.

Methods used were:-

- (a) Pitting with 'jembe'
- (b) Semi-circular bunds, similar to those shown in Fig.1.
- (c) Straight bunds 10m long with 5m gap left between bunds on the same contour. An interval of 20m was allowed between rows (5 ha).
- (d) Same as (b) but constructed with tractor-drawn ridging device (5 ha).
- (e) Same as (c) but constructed with tractor-drawn ridging device (5 ha).

In methods (b) to (e), structures were overlapped so that overflow from one structure was intercepted by the structure immediately downhill from it. Reseeding was carried out using methods (a) and (b) using 10kg/ha of Eragrostis superba and 3kg/ha of Cenchrus ciliaris.

'Fitting' was virtually a total failure. A survey of the semi-circular bunds in October showed that:

(i) Within semicircles 36% cover (mostly annual grasses) was obtained.

(ii) Outside bunds the cover was 14% (mostly herbs)

Perennial grasses germinated almost entirely within 1m of the bund. Germination tests on the seed used showed germination percentage to be only about 6% - possibly due to dormancy effects. But for this fact, the contrast might have been even greater. Methods (c) to (e) were installed after the beginning of the rains and were not reseeded so a quantitative comparison has not been made. However, the semi-circular bunds were obviously more effective than the straight bunds. Revegetation occurred only within $\frac{1}{2}$ to 1m uphill of the straight bunds but in about 90% of the area of the semi-circular ones. The ridging device caused soil compaction on each side of the bunds and this had a deleterious effect on revegetation.

It is felt that the hand-made semi-circular bunds could be very useful in re-establishing vegetation in areas like the Njemps Flats. The cost is 1/- per bund (100/- per ha) if done on a contract basis.

The reaction of the local people to the demonstration has been very encouraging. However, it remains to be seen whether they would be prepared to use the technique in their own areas without payment.

CONCLUSION

The danger of drawing conclusions from such a short period is readily acknowledged. Also, seasonal rainfall (March-June) in 1981 was considerably above average (409mm for 1981 as against an average of 267mm). However, although long-term average yield increases could not be predicted at this stage, it is felt that in a bad year, farms employing some type of water harvesting system would show an even larger advantage over farms not using the system. Despite the fact that contour ridges did not give the highest yield for the different water harvesting systems, the advantages of crop uniformity and low labour requirement may over-ride the yield advantages of the other systems. For slopes of less than 6% it has been provisionally adopted as a recommended system for farmers in lowland Baringo.

Preliminary analysis of the 'absorption waterway' concept indicates that it could be useful where a cut-off drain is indicated to prevent erosion and where farmers want to see the water used to advantage on their own farms rather than its being discharged.

The usefulness of simple water concentration techniques to rehabilitate denuded rangeland has been demonstrated. It would appear that hand-dug semi-circular bunds are the most cheap and effective. Care needs to be taken that grass seed has a reasonably high germination rate.

Trials will continue on both cropland and rangeland during 1982. The main thing that needs to be investigated is the spacing of the contour ridges, the correct catchment area for the semi-circular bunds, and a better understanding of the run-off characteristics of local soils needs to be obtained.

References

- Evanari, M., Shanon, L. and Tadmor, N. 1974. The agricultural potential of loess-like soils in arid and semi-arid zones. Proc. Intl. Semi. on Land Evaluation in Arid and Semi-arid zones of Latin America (pp 489-507) IILA, Rome.
- Pogel, M.M., 1975 Watershed management in Arid Zones. University of Arizona 1975.
- Hillman, F., 1980 Water harvesting in Turkana District of Kenya. Overseas Development Institute. Pastoral Network Paper 10p.
- Hudson, N., 1973 Soil Conservation, B.T. Batsford Ltd.
- Medina, J., 1976 Harvesting surface run-off and ephemeral stream flow in arid areas in Conservation in Arid and Semi-Arid Zones, pp 66-72. FAO Conservation Guide No. 3, Rome.
- Ministry of Agriculture, Kenya. 1978 Kenya Marginal/Semi-arid lands Pre-investment inventory. Report No. 10. Soils (Part 11, Baringo, Kerio Valley Area), Arid and Semi-Arid Lands Branch.
- Ministry of Agriculture, Kenya 1981 Run-off catching agriculture (one way to increase crop yields and reduce soil erosion in arid areas) C.D. & M.U. (Xeroxed report).
- Pratt, D.J., 1964 Reseeding denuded land in Baringo District, Kenya, 11 - Techniques for dry alluvial sites! E. Afr. Agr. For. J. 29, 243 - 260.
- Schwab, G.O., Frevert, R.K., Edminster, T.W., and Barnes, K.K. 1966 Soil and Water Conservation Engineering, Wiley.
- Shanon, L. and N. Tadmor, 1979 Micro-catchment systems Centre of Intl. Agric Co-operation, Min. of Agr., Rehovot, and Hebrew Univ. of Jerusalem.
- Whiteman, P. 1981 Personal Communication.

APPENDIX

The equation is derived as follows: Assuming that the height of the spillway (h) is less than the vertical interval between spillways, water ponded behind the spillway will be a wedge-shaped volume (y) given by

$$y = \frac{100 h^2 w}{2s}$$

where s is the percentage slope and w is the width of the waterway.

Area (A) between one spillway and the next is given by

$$A = \frac{100 V w}{s}$$

where V is the vertical interval between one spillway and the next.

$$\text{Average depth of water (d) is } y/A = \frac{100 h^2 w s}{2(100 s V w)} = \frac{h^2}{2V}$$

It is agreed that the ponded water is not spread evenly over the area between the spillways. Nevertheless, there will be a small amount of redistribution after infiltration and d is considered an important measure of the effectiveness of the waterway system in increasing infiltration. It has been used to calculate the seasonal increase in infiltrated water. Also, the expression shows that for a given height of spillway, the average depth of ponded water can be increased by decreasing the vertical interval between the spillways, which will, at the same time, improved the distribution.

USE OF MICRO-CATCHMENT FOR TREE PLANTING IN SOIL
CONSERVATION IN SEMI-ARID AREAS

By

Edmund G.G. Barrow

East Pokot Agricultural Project

Introduction

In the semi-arid areas (Kenya Eco-Climatic Zones IV-V; Pratt and Gwynne; 1977) with high ambient temperatures (minimum 16°C and maximum of 36°C or higher) and a variable, sporadic, rainfall (300-600 mm/annum), establishment of trees using traditional forestry practices can be risky. Mortality is often very high. Concurrently soil erosion and runoff tend to be very high (Thomas and Barber, 1981). By using a system of micro-catchments it is possible to concentrate runoff within the catchment of trees so that the runoff and eroded soil are held in the micro-catchment and soil erosion is reduced.

Micro-catchments are used in different parts of the world to aid in establishing trees where it would otherwise be very difficult. For example, in Israel, with 100 sq. m catchments in the Negev Desert, stands of a variety of trees which have been established in areas where rainfall is as low as 100 mm/annum (Evenari, Shanan, Tadmor, 1971). In Kenya, water harvesting methods have been used with success in a number of projects (Hillman 1981; Herlocker, Barrow, Paetkau, 1981; Ministry of Agriculture 1982). Such methods of micro-catchments and water harvesting are becoming more important in increasing the chances of tree establishment and crop success in semi-arid areas. Any method of slowing down runoff will aid in the prevention of water caused soil erosion. Thus use of systems of micro-catchments for tree planting not only aids success of tree establishment in a harsh environment but will aid in soil conservation on a micro-scale.

The East Pokot Agricultural Project has been aiding agricultural development in Nginyang division of Baringo District for the last 6 years in the fields of agriculture, range management, tree planting and women's development work (Barrow 1978, 1980). The area falls into Kenya Ecoclimatic zones IV-V (Pratt, Gwynne, 1977) and is marginal to semi-arid with the Kerio Valley being slightly higher in potential. Rainfall varies considerably, with the Kerio Valley being wetter, with an average over the whole area of 539 mm.

The vegetation is mainly composed of Acacia thickets and scrub bush with a poor to non-existent ground cover (except for the flush following the rains). Near the watercourses there is a better developed riverine woodland (Acacia tortilis, A. eliator, Tamarindus indica). The land is only marginal agricultural potential and this is limited to the more favourable areas. Most of the land is potentially productive rangeland, though this is limited by overgrazing and the encroachment of woody species. At present there is little perennial grassland.

Soil varies considerably over the project area. Most of the agriculture is in deep riverine Fluvisols (Siderius 1975). Over the rangeland the soil is often shallow, stony and easily erodible.

A poorly developed ground cover as a result of overgrazing, a high runoff rate - 70% (Barrow, Preliminary figures, 1982) and soil erosion has characterised the area for a long time.

Tree Planting Methods

In the Dry season (January - March) large holes should be dug at the planting site (60x60cm). On each side of the hole, to harvest the rainfall, a well constructed terrace should be built so as to guide the runoff to the planting hole. These catchments should be built so that they can hold a depth of 20-30cm water. Towards the extremities the terrace should taper off so as to allow excess water to be removed. The tips of the

micro-catchment should be on the contour. The length of the terrace will vary according to local rainfall but should be from 3-5m in length. (see Fig. 1)

During the rains, the trees should not be planted during the first few showers; rather, the runoff should be allowed to soak into the soil to form a sort of water reservoir on which the tree can later feed. Then, after the second or third shower, the trees can be planted with minimal root disturbance. Initially, the micro-catchment should be kept well maintained so as to make optimal use of the runoff. Towards the end of the wet season the soil around the base of the trees should be lightly dug to create a loose dry soil mulch.

Initially trees were planted at 3m x 3m spacing which would assume a 50% mortality so as to give a much larger final spacing. This gives an approximate planting rate of 1,100 trees/ha. It is now recommended that people plant at a minimum spacing of 5m x 5m (400 trees/ha).

Results

By referring to table 1 it can be seen that quite large quantities of runoff can be utilised. In calculating the volume of the catchment no account has been taken of the slope which, for most trees planted, is about 5%.

Table 1 indicates a large retention of water in the areas where trees are planted using such methods. It has not been possible to measure soil build up in the micro-catchments because of weeding the trees, but it is assumed that it is taking place.

In the four years of trials, over 20,000 trees of over 40 different varieties have been planted out using these planting methods, with an average mortality of 30% (This is high because of the species planted, many of which were found to be inappropriate to the area). All the species planted were useful in one or preferably more ways e.g. building timber, for fuel and charcoal, human and animal food etc.

The following tree species show promise for future development and planting in the dry areas of Baringo based on the trials conducted by the East Pokot Agricultural Project (Barrow, 1980, 1981).:-

- a) Acacia aneura
- b) Acacia halosericea
- c) Acacia tortilis
- d) Atriplex nimalaria
- e) Azadirachta indica
- f) Balanites aegyptiaca
- g) Cassia sturtii
- h) Eucalyptus camuldulensis
- i) Leucaena leucocephala (K8)
- j) Parkinsonia aculeata
- k) Prosopis juliflora (Baobab Farms)
- l) Prosopis juliflora (Israel)
- m) Prosopis chilensis

This List is by no means exhaustive but it represents the findings of the trees species planted by the Project. Other trees - for example A.senegal, A.elatior, Zizyphus mauritiana etc. could well be included.

Discussion

It is understood that trees on their own will not necessarily prevent soil erosion. Tree planting needs to be part of an appropriate management system which will ensure good ground cover and conservation methods in the semi-arid areas. Trees on their own will help reduce erosion by breaking up rain drops (and so dissipate their energy) and improve the soil water retaining capacity by a gradual build up of leaf litter in the soil. (Wenner 1980).

Thus the establishment of trees by using micro-catchment will be of a more indirect benefit to soil conservation. The micro-catchment itself plays a more important role in conservation, in addition to providing water for the tree.

Excessive loss of soil and water (through runoff) is a feature of much of the semi-arid areas (Thomas, Barber 1981). Semi-arid areas are more critical than arid areas because they are more erosion susceptible. This is due to more rainfall, more cultivation and higher population pressures than in the more arid lands. Thus it is particularly important that conservation measures be used in the semi-arid areas.

There is a relationship between runoff and ground cover. It appears that under low rainfall intensity and with good ground cover there is much less runoff, while at higher intensities there is a runoff rate similar to bare ground (Thomas, Barber 1981). It is assumed that soil capping still plays an active role even with a good grass cover. Below a ground cover of 20%, soil loss and runoff increase dramatically (Dunne 1977). In addition stone cover (which is prevalent over much of the area) helps reduce runoff (Barrow, 1982 - Preliminary figures), by enhancing infiltration (Thomas, Barber 1981).

It is also important to note that at the beginning of the rains, there is often very little ground cover. Since more intense rain is more likely to fall during the early rains, runoff is likely to be much higher than when a cover has been established.

The use of micro-catchments for tree planting, not only makes tree establishment more successful, but forms a useful soil conservation measure in retaining runoff at the micro-level and reducing soil loss. The soil will be moved to the micro-catchment. In addition once the trees have been established the micro-catchment provides a much easier environment for grass establishment both in the micro-catchment and along the terraces.

Micro-catchments are more efficient than large scale water harvesting schemes because there is less water conveyance and therefore reduced evaporation loss (National Academy Science, 1974). But they may be more labour intensive and so costly. It is estimated that on land of a 5% slope it costs K.shs. 600/-

per hectare at a tree density of 5m x 5m and a cost of 1.50 per hole and micro-catchment dug. (It is possible to dig between 10-15 such micro-catchments in a day). This may seem costly but it does give a much better chance of success for the tree as well as providing better soil conservation methods for the area planted than under normal forestry practise which is unsuitable to the drier areas.

In addition micro-catchments (modified) with a diameter of 8-10m have been used to aid grass re-establishment in denuded areas of Baringo (Ministry of Agriculture Baringo Pilot Semi-arid Area Project - 1982). Likewise the Baringo Pilot and Semi-arid Area Project has used micro-catchments in badly eroded and gullied areas to reduce gullying and increase the soil build up while at the same time establishing trees (Ministry of Agriculture BP SAAP 1982).

Since the use of micro-catchments slows down and to a large extent stops runoff in the immediate area, there is less likelihood of rill and gully erosion. It has been shown that rill and gully erosion will be gradually stopped because of reduced runoff and increased water retention and soil build up (Barrow, personal obs., Tilingwo Tree Plot, Kerio Valley, 1981).

Conclusion

The use of micro-catchments for the establishment of trees in the semi-arid area of Nginyang Division is mainly aimed at helping people to plant trees successfully. It is not necessarily meant to be used for large scale plantings. Since many areas of Baringo District show chronic soil erosion, any form of soil conservation no matter how small will be of benefit. The fact that such micro-catchments not only increase the survival rates of trees planted, but also create a better environment for grass re-establishment, can only make the practise more advantageous.

References

- Barrow E.G.C., 1978. Catholic Diocese of Nakuru, East Pokot Agricultural Project, Progress report. Mimeo.
- Barrow E.G.C., 1980. Catholic Diocese of Nakuru, East Pokot Agricultural Project, Progress report, 1978-80. Mimeo.
- Barrow E.G.C., 1981. Multipurpose Trees: Current experiences and future Possibilities, in Louise Buck Ed; Proceedings of the Kenya National Seminar on Agro-forestry 12-22 November 1980. International Centre for Research in Agro-forestry, Nairobi.
- Dunne T., 1977. Intensity and control of soil erosion in Kajiado District. Report to FAO/Government of Kenya.
- Evenari M., Shanan L., and Tadmor, N. 1971. The Negev - the Challenge of a Desert. London, OUP.
- Goor A.Y., and C.W. Barmey, 1976. Forest Tree Planting in Arid Zones. Ronald Press, New York.
- Herlocker D.J., Barrow E.G.C., and P. Paetkau, 1981. A Preliminary report on Trial plantings of woody species in arid and semi-arid Northern Kenya. In Louise Buck Ed; Proceedings of the Kenya National Seminar on Agro-Forestry 12-22 November 1981. International Centre for Research in Agro-forestry; Nairobi.
- Hillman F., 1981. Water Harvesting in Turkana District, Kenya. Overseas Development Institute, Agricultural Administration Unit, Pastoral Network Paper 105.
- National Academy of Science; 1974. More Water for Arid Lands-Promising Technologies and Research Opportunities. Washington, National Academy of Science.
- Pratt D.J. and Gwynne M.D. 1977. Rangeland Management and Ecology in East Africa. Hodder and Stoughton, London.
- Republic of Kenya; 1982. Ministry of Agriculture Baringo Pilot Semi-Arid Area Project. Annual Report for 1981.
- Republic of Kenya; 1982. Ministry of Agriculture Baringo Pilot Semi-Arid Area Project. Soil and Water Conservation Report 1981. Mimeo.
- Siderius W. 1975. Soil resources of the Upper Kerio Valley. A preliminary investigation. Kenya Soil Survey Site evaluation report No. 24. Mimeo.

Thomas D.B. and R.G. Barber; 1981. Control of soil and water losses in semi-arid areas, some problems and possibilities. Paper presented to International Workshop on strategies for developing the resources of the arid and semi-arid areas of Kenya, Nairobi.

Wenner C.G.; 1980. An Outline of Soil Conservation in Kenya. Soil Conservation Unit, Ministry of Agriculture.

Wenner C.G., 1981. Trees in Erosion and Soil Conservation in Kenya. In Louise Buck, Ed. Proceedings of the Kenya National Seminar on Agro-forestry, 12-22 November 1980. International Centre for Research in Agro-Forestry, Nairobi.

Weber F.R.; 1977. Reforestation in Arid Lands. Volunteers in Technical Assistance Manual Series No. 37E.

Table I: Micro-catchment water holding capacity

| Terrace length(m) | Catchment area (m ²) | Vol. @ 30cm deep (l) | Vol. @ 60cm deep (l) | Vol. X (l) | Vol. Y (l) |
|-------------------|----------------------------------|----------------------|----------------------|------------|------------|
| 3 | 5 | 150 | 300 | 640 | 1,280 |
| 4 | 9 | 270 | 540 | 880 | 1,760 |
| 5 | 12.25 | 370 | 740 | 1,080 | 2,160 |

Vol. X = Total volume of water in catchment and planting hole after two showers of rain assuming that the catchment completely filled up to a depth of 30cm.

Vol. Y = Total volume of water in catchment and planting hole after two showers of rain assuming that the catchment completely filled up to a depth of 60cm.

Note:- This table does not take into account slope of the land or the quantity of water that infiltrates during the rain shower.

.....

Figure I: Surface and Sectional View of Micro-Catchment

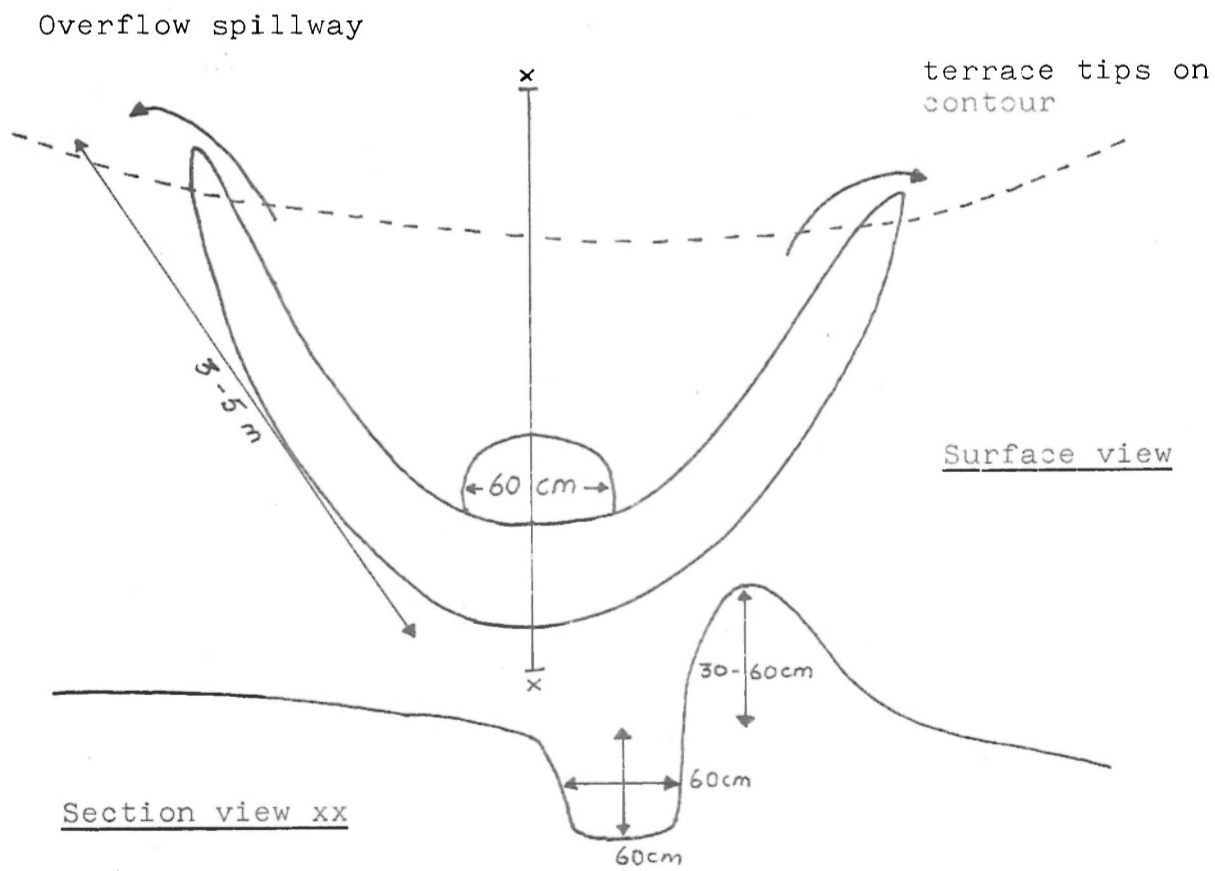

EFFECT OF PLANT RESIDUES ON WATER HOLDING CAPACITY
OF THE SOIL IN NO-TILLAGE SYSTEMS

By

R.W. Michieka
Department of Crop Science
University of Nairobi.

INTRODUCTION

Minimum or no tillage is planting of seeds into soil without any pronounced or elaborate tillage operations. A slit is made into the soil and seeds are precisely placed in sod without further soil disturbance. There is no primary or secondary cultivation before planting. Several terms have been used - no-tillage, reduced tillage, minimum tillage, zero-tillage, conservation tillage - all are closely related except in situations where different crops (seeds) are planted using different kinds of equipment. The terms will be used interchangeably.

Reduced tillage operations are gaining popularity because of improved soil and water conservation which results. (Witt and Herron, 1980). Not all land is suitable for conventional tillage crop production. Steep terrains which are subject to water erosion could not be effectively utilized under conventional tillage. Growing populations need more land for food production. High food requirements have led to excessive pressures on the land and many of the techniques utilized by man for food production cannot cope with the population increases (Borlaug, 1982). The existing crop land cannot adequately produce enough food for the increasing world population.

In this paper observations on the effects of plant material on water infiltration will be discussed. Various types of tillage systems will be mentioned and a number of herbicides utilized in no-tillage crop production will be mentioned. Research work in respect to various tillage systems has been focussed mainly on maize production.

FIELD OPERATIONS

Many farmers practise conventional tillage which involves primary and one or more secondary operations depending on the type of crop to be planted. In most cases, primary tillage operation involves preparation of a field which may have been under cultivation previously, fallow, or virgin land. The plant material which is left on the land after the primary cultivation varies a great deal. This depends on the ecological zone, soil type, existing vegetation, amount of rainfall, and time of cultivation. In some cases farmers practice trash farming, which is a method of primary cultivation where the soil is made loose but plant residue is left on the soil surface without further disturbance. This helps in checking soil erosion. Trash farming hence requires no secondary tillage operations. This is not a common practice since farmers usually employ secondary tillage operations to ensure uniformity of the field for planting and further destruction of any existing plant or plant parts in the soil.

Machinery utilized for cultivation varies a great deal depending on the area and crop to be planted. The existing vegetation on the field further dictates the type of equipment to be used during cultivation. These considerations determine how best a tillage operation is performed and how many subsequent secondary cultivations are needed. The primary aim is to bury as much plant residue underneath the soil as possible during these cultivations. This will eventually reduce weed infestation in that field. In sloping, easily erodable, terrain, residues left on the soil surface may be of an advantage.

PLANT RESIDUES

All tillage operations affect the amount of plant residue left on the soil surface. This residue reduces soil erosion by water or wind. Water infiltration is encouraged hence soil moisture is conserved and the amount available to the crop is increased. In semi-arid areas, moisture availability to the crop is important and plant residue left on the soil surface helps conserve available moisture for the plant.

In no-tillage situations, some foliar applied herbicides play a major role as 'tillage tools' in primary and secondary operations. The availability of quick knockdown foliar-active herbicides have made the concept of no-tillage maize production possible. Paraquat (a bipyridilium ion) and glyphosate (glycine derivative) have been widely used to facilitate quick vegetation kill for planting. A good arsenal of soil-applied residual herbicides also play an equally important role in checking germination and growth of other weeds later in the season.

Under minimum or no-tillage crop production, plant residue, which has been killed by herbicides, varies in length and quantity. In conventional tillage operations, most of the plant residue will be shredded into several pieces and buried underground where it decomposes, whereas that killed by herbicides will remain above the ground as dead plant mulches. The original plant population will not change much even after the plants are dead, however, foliage will fall on the soil and start to decompose. The planter, therefore, must be capable of placing seed precisely in this dead plant matter without any further soil disturbance. In most cases planting is done soon after herbicide application and plant parts start to drop on the ground as the seeds begin to germinate.

The greatest advantages in no-tillage crop production are soil and water conservation in erodable terrains and semi-arid regions respectively. Conventional tillage systems sometimes lead to wind and water erosion. A cultural practice which helps to maintain high soil infiltration rate to reduce runoff could benefit many farmers. A farming technique, therefore, which maintains a dead or live mulch on the soil increases infiltration. Research work in the tropics by Greenland and Lal (1977) showed that direct rain drop impact on a bare soil surface decreased infiltration capacity and rate and this resulted in increased runoff and erosion. Further work by the same authors in high humid areas of the tropics indicated that about 232.6 tonnes of soil per hectare per year are lost on bare ground whereas only 0.2 t/ha/yr are lost under mulched ground. The difference is enormous. In addition to minimizing soil loss in high rainfall areas, plant

residues help conserve soil moisture in dry areas where crops would not have normally been grown. The residue maintains soil moisture in the seed zone and encourages optimum germination through its mulching effect. This is particularly important in dry land areas where all the rainfall should be conserved in order to produce a crop. Other advantages include increased organic matter of the soil which is an important component of soil fertility. Precise placement of costly fertilizer during planting is possible and economical. Reduced costs due to one or two mechanical passes are experienced instead of several during conventional tillage-operations.

CONCLUSION

Maize production under no or reduced tillage systems has been promoted more than any other crop. It is important to note that the system is useful and practical where soil erosion can occur. The system is more applicable in semi-arid areas where moisture has to be conserved. The value of certain foliar- and soil-applied herbicides cannot be overemphasized.

Soil erosion is one of the most devastating problems in crop production. Farmers are known to abandon severely eroded lands due to excessive soil loss. Minimum tillage can reduce intensive cultivation and land pressure would be reduced once more land is put into use. Steep terrains would be put into crop production. Reduced tillage costs would be an added advantage.

REFERENCES

- Banks, P.A., and Robinson, E.L., 1981. Effect of Tillage Practices on the Persistence of Three Herbicides. Abstracts, Weed Science Society of America.
- Beeler, D. 1981. Reduce Tillage Systematically. Agrichemical Age. 25(2) 54.
- Borlaug, N.E. 1982. Food and Population, the Unequal Equation. In the IRDC Reports Vol. 10 (4) 22.23.
- Greenland, P.J., and Lal, R. 1977. Soil Conservation and Management in the Humid Tropics. A Wiley-Interscience Publication.
- Meadows, D.H., Meadows, D.L., Rauders, J. and Behrens III, W.W. The Limits of Growth. Universe Books, New York.
- Michieka, R.W. 1980. Herbicide Performance in Conventional Tillage Maize (Zea mays L.) Production in The Tropics. Abstracts, Weed Science Society of America.
- Michieka, R.W., and Akobundu, I.O. 1980. Evaluation of Herbicides for Zero-Tillage in Maize (Zea mays L.). Production in the Humid and Sub-humid Tropics. Abstracts, Weed Science Society of America.
- Stahlman, P.W. and Thompson, C.A. 1980. Reduced Tillage versus No-Tillage Production of Winter Wheat and Grain Sorghum. Abstracts, Weed Science Society of America.
- Walker, J.D., and Rasmussen, V.P. 1980. Weed Control Recipes for No-Till and Minimum Tillage Western Wheat Production. Abstracts. Weed Science Society of America.
- Witt, W.W., and Herron, J.W. 1980. 'Reduced-Tillage Systems - Past, Present, Future.' Weeds Today, 11:(1) 9-10.

THE ROLE OF AGRO FORESTRY IN SOIL AND WATER
CONSERVATION IN THE TROPICS

By

Amare Getahun
Kenya Renewable Energy Dev. Project
Ministry of Energy

I AGRO-FORESTRY DEFINED

Climate (radiation and temperature), water and soil are the main factors which determine the capacity of land to sustain farming. Temperatures in the tropics are nearly ideal for year-round plant growth and in-coming radiation is often more than adequate. When these environmental factors are adequately matched by water resources and soil conditions, high agricultural crop yields are observable in the tropics. Under these conditions, an agriculture involving trees appears to be an effective land use system where both high and sustainable yields are achieved. Such an integrated tropical land use involving trees, crops and/or livestock is known as Agro-forestry.

The success of agro-forestry as a productive and appropriate system of land use is largely due to the effective enriching and/or conserving role of trees and shrubs in the eco-system through nutrient cycling, soil organic matter and litter build-up and erosion control. The system employs the positive and complementary inter-relationships of the enterprises (forestry, arable crop farming, and livestock) both in time and space. (Tables 1, 2 and 3). The significance of vegetation cover is illustrated in Fig. 1.

II AGRO-FORESTRY SYSTEMS : TRADITIONAL AND MODERN

Agriculture (including livestock) and forestry systems of land use often form a dichotomy; agro-forestry attempts to reduce this. Hence, some forms of agro-forestry operate within a forestry-base system while others operate under agriculture.

1. Under Agriculture-Based Systems

- .1 Bush (natural) fallow-crop rotations
- .2 Planted fallow-crop rotations
- .3 Alley cropping (organic farming)

2. Under Forest Systems

- .4 Taungya or shamba systems
- .5 Shifting cultivation
- .6 Multi-storey agriculture (compound permanent farming)

Shifting cultivation and taungya or shamba systems exhibit a relatively good level of productivity rejuvenation capacity due to the woody fallow phase of the land use cycle. Indeed, the productivity and stability of these systems breaks down when the fallow period in the cycle is effectively shortened. This is due to the steady decrease in the density or elimination of trees and shrubs in shortened fallows and a steady increase, instead, of grasses and herbaceous flora which are less effective in maintaining soil productivity. (Table 4). The following is a brief description of the more important and widespread systems:-

a) Shifting Cultivation and Bush Fallow Crop Rotation Farming Systems

The productivity of arable crop farming in traditional agriculture is positively correlated with the duration and type of bush fallow. Under increasing population there is pressure to reduce or eliminate the fallow cycle resulting in a decline in soil fertility and crop yields within three to six years of continuous crop cultivation.

Within tree and shrub species, some are more effective in maintaining and building up soil fertility than others. Fast growing leguminous woody species, as well as those species that produce large amount of plant biomass per unit of time are more effective in fertility rejuvenation. (Getahun, Wilson, and Kang, 1981). Farmers, through experience, have recognised these differential levels of species effectiveness and often selectively retain or plant such species to reduce

the fallow duration while increasing or at least maintaining land productivity (Table 4 & 5). Through such means, farmers in SE Nigeria are able to effectively reduce the fallow period to under seven years as compared to 15 or more years required in natural fallows or in shifting agriculture in the same region. Table 4 gives the frequency of the most common woody species many of which are leguminous in improved natural fallows in SE Nigeria.

b) Planted Fallows- Crop Rotation Systems

Because improved natural fallows could reduce the fallow length required to rejuvenate fertility, it can be expected that planted fallows can be composed of one or more economic woody species. Such planted fallows could be established within the cropping phase and cropping repeated at each cutting cycle. Burning as a form of land preparation must be minimised as well as branches and barks left on the ground to ensure fertility. Woodfuel and pulp species such as Gmelina arborea, Sesbania grandiflora, Leucaena leucocephala, Samanea saman, Mimosa scabrella, etc., could be produced effectively under this system. These planted fallow woody species could be harvested between three and seven years, with food crop intercropping during the initial one to two years. The system also minimises land clearing and tillage needs because soil bulk density is reduced and moisture kept high.

c) Alley Cropping System

Alley cropping is an advanced form of planted fallow system in which fast-growing woody species, often leguminous, are inter-planted with food crops and periodically cut to provide organic matter and nutrients while the cutting also facilitates the food crop cultivation by minimizing competition for light and/or moisture during the cropping season. A typical example is Leucaena/maize intercropping in which the Leucaena is usually established at 4m intervals in the maize crop and once established (i.e. after 18 or more months), the Leucaena is then periodically cut back for green mulch and allowed to

grow during the dry season, often reaching 3 to 4 meters high and resulting in firewood and staking material for vining crops. Under this system, the land lost to the Leucaena is insignificant while product yields and soil fertility build-up are high. Furthermore land management costs such as land preparation and weeding are greatly reduced.

Other woody species useful in alley cropping with maize, rice, yam or cassava include Gliricidia sepium, Sesbania grandiflora, Tephrosia candida, Acioa barterii, and to a lesser extent, Cajanus cajan and Flamingia congesta. Some of these woody species are also useful for crop-livestock (agro-silvopastoral) system of land use such as in small ruminant production. A cut-and carry (zero grazing) system is possible with Leucaena and Gliricidia.

The forest-based agro-forestry systems as a group such as (a) the Permanent Compound Farming (Multi-story Plant Association), (b) the Permanent Tree Crop Agriculture, and (c) Industrial Forest and Tree Crop Plantations, exhibit a more stable and productive system of land use (Tables 6 and 7). Table 1 and Fig 1 show soil and hydrological impacts of trees indicating their pivotal role in environmental maintenance. Annual soil loss from forested catchments and cropped lands with slopping topography in the highlands of Kenya is estimated at 0.2 to 0.3 and 20-40 tons/ha/yr, respectively (Dunne, et al., 1982).

Traditional tree crop farming compared to food-crop-based systems, appears to be 2 to 8 times more effective for the combined labour and land inputs and may give 7 to 14 times more returns while still being ecologically more stable (Table 6 and 7). Tree cropping agriculture is particularly attractive to small holder farmers because of its lower land and labour requirement and less pronounced labour peaks.

Actual product yields and total farm income are consistently high in tree crop farming and a farmer is better off if he shifted to tree crop systems altogether, such as T-1, (Table 7) if he did not have to produce his own food, particularly,

when one considers an average farm family can operate annually up to 25 acres of tree crops as opposed to only 5 acres of arable crop farming (Getahun, 1981).

The cocoa, kola nuts, oil palm, coconut and rubber tree crops farming of West Africa; the citrus, coffee and tea farming in Eastern Africa and the Eucalyptus woodlots of the Ethiopian highlands are good examples of the profitability of tree crop agriculture, even without food crop intercropping, as in the case of Eucalyptus plantations in Ethiopia and Malawi.

Tree crop farming systems remain productive for 25 to 100 years with minimal use of purchased fertilizers. Tree crops are however, more productive as mixed farming than as monoculture. Increased yields of tree crops with bananas, pineapple, cucurbits and rice, are largely due to weed control and improved soil conditions (World Bank, 1980). In Kenya, coffee intercropped with beans, appears to be a sound farming practice.

III ENRICHING PRINCIPLES OF AGRO-FORESTRY (TREE) SYSTEMS

Tree species are effective, through their extensive root systems in increasing base elements such as N,P,K, Ca, Mg, Na, in the plant biomass (both in the root and above ground plant biomass). Biomass is deposited in the top soil as litter falls and the accumulated organic matter includes dead and decomposed roots. The N-contribution to the soil through nitrogen-fixation and mycorrhizal activities from atmospheric sources by woody legumes is as important as the capture and accumulation of base elements by the tree canopy and the incorporation into the soil surface by precipitation. Kellman (1980) has shown the enrichment of Ca, Mg, K, Na, P and N by canopy capture to be significant in a tropical savana region. Organic matter through root decay represents as much as 20-25% of the total biomass produced by woody species (Nair, 1981). Site enrichment by woody legumes is significant. Experimental results showed increase in crop yields of 300-400 kg/ha of millet and peanut grown under Acacia albida (Felker, 1978). Such soil productivity improvements when combined with the woodfuel and animal fodder make agro-forestry systems, biologically and economically efficient.

Nitrogen the most common nutrient deficiency, and one, which probably restricts plant growth in general more than any other element is better maintained in agro-forestry systems. Organic matter accumulation is also significant in agro-forestry systems.

REFERENCES

- Beets, W.C. 1978. The agricultural environment of eastern and southern Africa and its use. Agriculture and Environment 4, pp. 5-24.
- Dunne, T, Aubry B. and Wahome, E.K. 1980. Effect of woodfuel harvest on soil erosion in Kenya. Kenya Rangeland Ecological Monitoring Unit.
- FAO/UN (na). Fighting World Hunger. FAO, Rome. p. 76.
- Felker, P. 1978. State of the Art: Acacia albida as a complementary permanent intercrop with annual crops. Grant No. AID/Afro-C-1361 University of California, Riverside. 143p.
- Getahun, A. 1981. The most productive and stable tropical land use: The case for agroforestry in the humid and sub-humid Tropical Africa. (Mimeog) p. 8.
- Getahun, A., Wilson, C.F. and Kang, B.T. 1981. The Role of trees in land and soil management in the humid tropical lowlands, in Agroforestry in the African Humid Tropics, Proceedings of a Workshop held in Ibadan, Nigeria 27 April to May 1981, United Nations University, 28-35.
- Kellman, M. 1980. Soil enrichment by neo-tropical savanna trees. J. Ecol. 67: pp. 565-577.
- Lal, R. 1981. Deforestation of tropical rainforest and hydrological problems. In Lal and Russell, (Editors). Tropical Agricultural Hydrology. J. Wiley & Sons.
- Nair, P:K.R. 1981. Soil Aspects of Agroforestry, ICRAF (draft) p. 83.
- World Bank, 1980. A study of tree crop farming systems in the lowland humid tropics. Vol. II, AGR/T/2.

Table 1: Effects of Methods Deforestation on Runoff and Erosion
(Lal, 1981)

| Clearing Treatment | Runoff (mm) | Soil Loss (t/ha) |
|--|----------------|---------------------|
| Traditional | 2.6 | 0.01 |
| Manual clearing - No tillage | 15.5 | 0.4 |
| Manual clearing - Conventional tillage | 54.3 | 4.6 |
| Shear blade - No tillage | 85.7 | 3.8 |
| Tree pusher - No tillage | 153.1 | 15.4 |
| Tree pusher - Conventional tillage | 250.3 | 19.6 |

Table 2: Effects of Fallows and Continuous Cultivation on Soil Productivity (IITA, Annual Report 1980)

| Treatment | pH (H ₂ O) | Total N % | CEC MEQ/100 | Exch. MEQ/100 G | Cations CA | MG | K | Bulk Density g/cm ³ 0-5cm |
|-----------------------------|--------------------------|-----------------|----------------|-----------------------|---------------|------|------|--|
| Cont. Cult. (Maize/Cassava) | 5.6 | 0.15 | 3.40 | 2.04 | 0.42 | 0.32 | 1.25 | |
| Planted Fallow (Pigeon Pea) | 6.0 | 0.23 | 3.42 | 2.18 | 0.64 | 0.32 | 1.10 | |
| Natural Bush Fallow | 6.5 | 0.19 | 5.14 | 3.53 | 0.91 | 0.41 | 0.88 | |

Table 3. Hydrological Cycle in Natural and Disintegrated Ecosystem (After Egunjobi unpublished data 1980)

| Hydrological Events | Under Forest % | | Bare Mountain % | |
|--------------------------------|-------------------|------|--------------------|------|
| | Loss | Gain | Loss | Gain |
| Absorbed by (Tree) Vegetation | - | 25 | - | - |
| Evaporation/Evapotranspiration | 15 | - | 40 | - |
| Soil Infiltration | - | 25 | - | 5 |
| Surface Runoff | 25 | - | 50 | - |
| Total | 40 | 50 | 90 | 5 |

Table 4. Vegetation density and botanical composition of 3-year and 7-year old bush fallows in E. Nigeria. (Amaza, Akukwe, Getahun, Okafor, et al. 1981 unpublished).

| Species | Akwa Density/ha (%) | | Ikot-Ekpene Density/ha (%) | |
|---------------------------------|------------------------|-------|-------------------------------|-------|
| | 3 Yr | 7 Yr. | 3 Yr. | 7 Yr. |
| <i>Dalium guineense</i> | 48.41 | 40.96 | 0.76 | - |
| <i>Anthonatha macrophylla</i> | 26.98 | 34.57 | 53.44 | 33.73 |
| <i>Pentaclethra macrophylla</i> | 2.38 | - | - | - |
| <i>Acioa barteri</i> | 12.70 | 23.94 | - | 3.61 |
| <i>Alchornea cordifolia</i> | 9.52 | 0.53 | 15.27 | 51.20 |
| <i>Napoliana imperialia</i> | - | - | - | 3.61 |
| MM (unknown) | - | - | 30.53 | 7.83 |
| Total/ha | 1008 | 1504 | 1048 | 1328 |

Table 5. Chemical composition of leaves including young branches of selected woody species from a seven-year old natural bush fallow in Awka, Imo State, E Nigeria (March 1981)

| Species | Total N % | Total P % | Ca % | Mg % | K % | Na ppm | Mn ppm | Fe ppm | Cu ppm | Zn ppm |
|--|-----------|-----------|------|-------|------|--------|--------|--------|--------|--------|
| <i>Anthonatha macrophylla</i> (legume) | 2.12 | 0.23 | 0.15 | 0.026 | 1.11 | 206 | 52 | 324 | 18 | 24 |
| <i>Dalium guinensis</i> (legume) | 1.23 | 0.25 | 0.28 | 0.026 | 0.74 | 206 | 794 | 279 | 15 | 40 |
| <i>Pentaclethra macrophylla</i> (legume) | 0.93 | 0.12 | 0.27 | 0.025 | 0.47 | 202 | 58 | 563 | 17 | 13 |
| <i>Alchornea cordifolia</i> (Euphorbiaceae) | 2.79 | 0.14 | 0.31 | 0.024 | 0.90 | 172 | 57 | 301 | 20 | 23 |

1. Samples derived from bushes within a 25 x 25 m plot and represent that part normally slashed and burned before planting food crops. Analysis made at Analytic Services Laboratory, IITA, Ibadan.

Table 6. Traditional farming enterprises and their relative productivity in the humid and sub-humid lowlands of Nigeria.

| Enterprise Group | Labour use intensity (L) Mandays/ha. ^{1/} | Land use intensity (R) % | Production inputs (P) (L / R)100 | Remarks |
|---|--|--------------------------|----------------------------------|------------------------------|
| C-1 Bush Fallow Agric | 210 ^{3/} | 25 | 840 | Stable, good yields. |
| C-2 Rudimentary (Semi) Sedentary Agric | 150 ^{3/} | 75 | 200 | Unstable, poor yields |
| T-1 Tree Crops Agric. ^{2/} | 110-130 (116) | 90-105(93) ^{3/} | 120 | Stable, good yields. |
| T-2 Permanent Compound Agric. | 140 | 200 ^{3/} | 70 | Very stable and good yields. |
| M Mixed enterprises (C-1,T-1,T-2) ^{4/} | 138 | 95 | 140 | Aggregate yields, good. |

1/ Labor requirements of enterprises are difficult to establish and the values used are based on available data which are highly variable.

2/ Includes planted fallows (taungya), alley cropping, and permanent tree (cash) crops.

3/ Land use intensity values (R) are often under-estimated for arable cropping (C-1 and C-2) which are often multiple-cropped, and tree crop systems over-estimated as the period of establishment is not usually accounted for.

4/ Based on survey data in E. Nigeria, which showed mixed enterprises to be made up (by area of land) of 65 (T-1), 25% (C-1) and 10% mixture of C-1 and T-1 enterprises.

Table 7. Traditional Farming Systems (enterprises) and their relative productivity in the humid and sub-humid lowlands of Nigeria (1980)

| Enterprise Group | Production Inputs (P) (R x L) | Income/P Ratio |
|-----------------------------|----------------------------------|-------------------|
| C-4 Bush Fallow Agric. | 840 | 1 |
| C-2 (Semi) Sedentary Agric. | 240 | 2 |
| T-1 Tree Crops Agric. | 120 | 14 |
| T-2 Compound Agric. | 70 | 35 |
| M Mixed Enterprises | 140 | 14 |

Figure 1, Rate of soil loss at different degrees of slopes and vegetation cover.

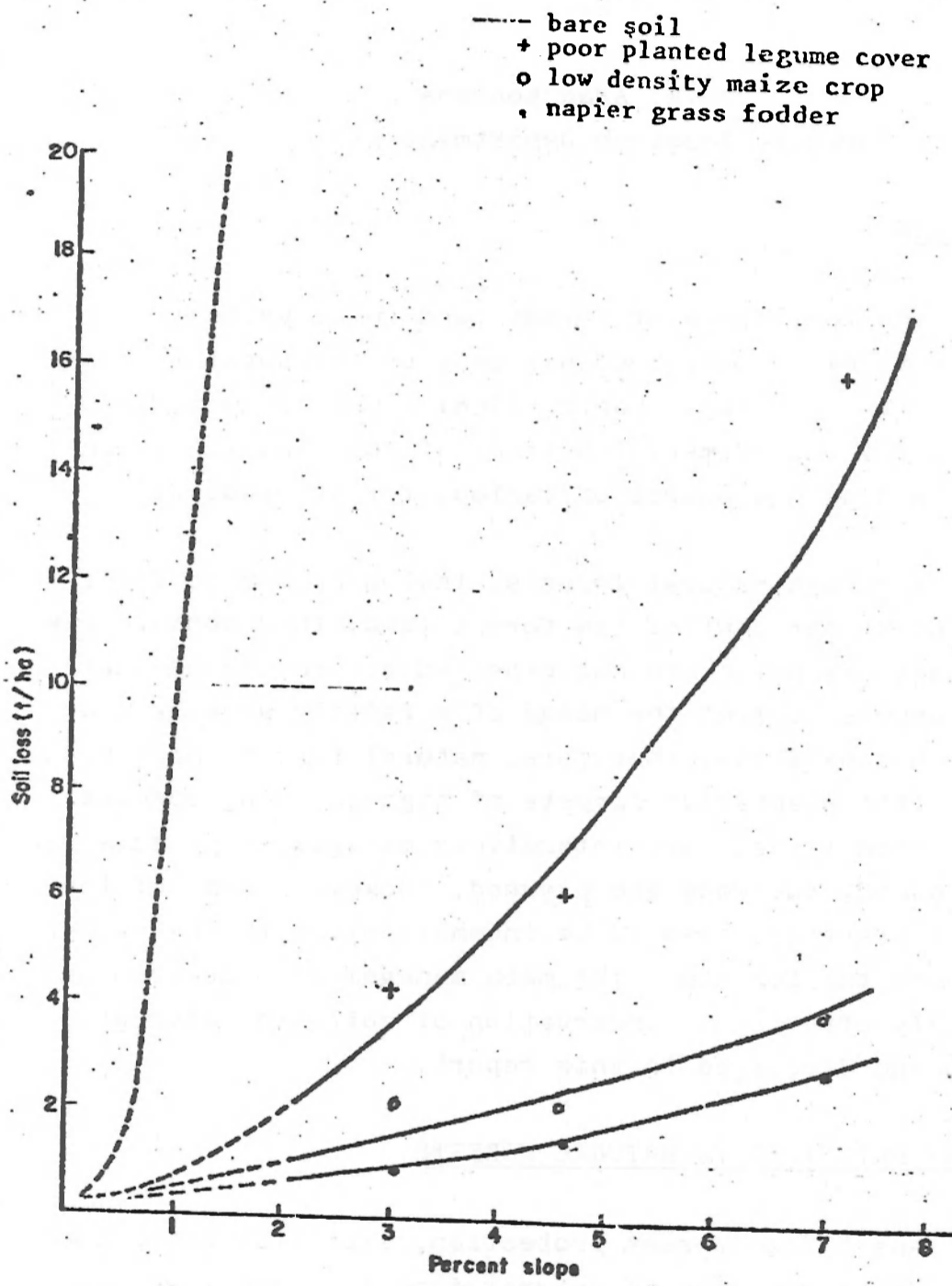

Source: Beets, 1978.

EFFECTS OF FOREST MANAGEMENT PRACTICES ON
SOIL AND WATER CONSERVATION IN
KENYA FORESTS

By

P.K. Arap Konuche
Forestry Research Department/KARI

INTRODUCTION

The total area of forest land in Kenya is 1.7 million hectares or only 3.03 per cent of the total land area of the country (Sessional Paper, 1968). This is a very low percentage for the primary functions of soil and water conservation and as the source of various forest products.

Although natural forests, including bamboo forests, cover about 91 per cent of the forest land, they contain low yielding species which are not expected to provide adequate forest products to meet the needs of a rapidly growing population. In some areas, therefore, natural forests have been converted into plantation forests of high yielding species. The plantation forests are intensively managed to produce saw logs, pulpwood, fuelwood and plywood. However, some of the management practices seem to be incompatible with the protective role of the forests. The main management practices and their likely effects on conservation of soil and water are presented and discussed in this report.

MANAGEMENT PRACTICES IN NATURAL FORESTS

Apart from forest protection, exploitation is the main management activity in natural forests. The mode of exploitation is by selection felling which began about 70 years ago (Logie and Dyson, 1962). This system of selective cutting has resulted in the remaining forest getting poorer and poorer with regard to desirable species (Mathu, 1978). More recently, however, the selection system has been slightly modified to allow for management of the remaining natural forests on a sustained yield basis without changing the structure and diversity (Mburu, 1979).

In the current practice of selection felling, cutting is restricted to trees above specified diameter limits; but where most of the trees are above the specified diameter, cutting is evenly distributed within the forest so that large gaps are not created. Undesirable species are not cut in order to maintain the diversity of the forests.

The selection felling system leaves the soil covered and is a method suited for conservation of water and soil (Taylor, 1962). However, heavy machinery has recently been introduced for logging in some forest areas. Such heavy machines create large openings and cause severe soil disturbance and compaction of logging tracts or landings. These practices result in reduced infiltration rates, increased surface runoff and are detrimental to soil and water conservation. The use of heavy equipment should therefore be discouraged.

MANAGEMENT PRACTICES IN PLANTATION FORESTS

The main management or silvicultural practices in plantation forests are site preparation, tending including pruning and thinning, and harvesting. These practices are not only aimed at minimising the costs of establishment and harvesting but also improving the quality of the end products.

Site Preparation

The success of plantation can depend markedly on the quality of site preparation (Chavasse, 1969). In Kenya, forest plantations are established through the shamba system. This is a system that combines cultivation of trees and agricultural crops in the early years (Forest Department, 1939; Pudden, 1958; Logie and Dyson, 1962; and Wanyeki, 1981). The normal method of site preparation is to clear exploited forest, bamboo thickets or bushland. Clearing is done manually using axes, slashers, and machetes. Clearing is followed by piling and burning of the wood brush. Burning is normally done at the start of the dry season and about 4 months before planting.

Clearing is not allowed on steep land with more than 30% general slope nor is it allowed less than 30 metres from a stream, spring, river course or well defined water course (Pudden, 1958; Logie, 1969). However, antierosion measures are not normally undertaken as the land is soon to be put under trees.

Agricultural crops are normally grown alone in the first year but in the second year, trees are interplanted with agricultural crops. Agricultural crops are also grown in the third to the fourth year or until the cultivation becomes no more economical because of the shading effect of the trees.

The shamba system results in soil deterioration through clearing, burning, and cropping. The soil is normally exposed during the dry season and as the first rains normally come in storms, lack of soil cover reduces infiltration rates and this leads to increased runoff and soil erosion. Pereira et al (1962) and Vompersky et al (1981) found that there were more suspended soil sediments in water flowing from cultivated land compared with that from forested land. Though the shamba system is the best method of establishing forest plantations, it is detrimental to soil and water conservation. The period of shamba cultivation should therefore be reduced from 4 or 5 years to 2 years. This can be done without affecting the growth of the trees by planting trees in the first year and allowing cultivation upto the second year only.

Plantation Species

The principal species in forest plantations are Cupressus lusitanica Miller (Cypress), Pinus Patula Schl. and Cham, Pinus radiata D.Don and more recently Eucalyptus saligna Sm (Sydneybluegum). These species have been selected largely on account of fast growth and not so much on the water and conservation values. Cypress and Pines constitute 84 per cent of the existing forest plantations and the remaining 16 per cent is divided equally between Eucalyptus species and indigenous species.

Although not much is known about the effects of plantations of exotic species on soil and water conservation, Pereira et al, (1962) found that plantations of P. patula did not cause deterioration in the hydrological regime in years of establishment. Other species are likely to have the same effects but only in early years of establishment.

In some countries, Kenya included, there has been some concern that planting of eucalypts (Eucalyptus species) has possible adverse effects on local water supply (Anon., 1971; Gosh et al, 1978; Nshubemuki and Somi, 1979) and may result in drying up of springs, streams, or rivers. The fears seem to have risen because eucalypts have been planted successfully near swampy areas or have been used for reclamation of partially drained swamps.

Although there is considerable evidence that eucalypts have drying effects when planted in areas with abundant supply of moisture, there is also enough evidence that they use water conservation mechanism when moisture is limiting (Nshubemuki and Somi, 1979). Other tree species also seem to have some drying effects. In some high rainfall areas of Kenya, conversion of some natural forests into farmlands has resulted in occurrence of swamps in depressions or valleys where the swamps did not exist before clearing of virgin forest. However, the effects of eucalypts would be more noticeable compared with that of indigenous slow growing species. This is probably because eucalypts are very fast growing and rapid development of root systems increase infiltration and subsurface drainage.

In Australia, the home of eucalypts, stands of eucalypts have been replanted with conifers with no noticeable changes in water yields (Anon, 1971). Most eucalypts in Australia are also found in areas receiving annual rainfall of 250-750mm (Rodgers, 1953) suggesting that these species are not great water demanders.

It would therefore appear that like any other tree species, eucalypts have drying effects once established in sites with excess moisture. However, when planted away from such sites, they have unlikely to have adverse effects but rather beneficial effects as they increase infiltration and percolation of water into deep layers for storage. In dryland, the eucalypts may have adverse effects but only if planted in large scale and very close to ephemeral streams or springs.

Tending Practices

In forest plantations, trees are usually planted at high initial stocking ranging from 1110 to 1600 trees per hectare. The reasons for adopting such high initial stockings are to get early suppression of weeds and to provide enough trees from which to select the best for the final crop.

The two main tending or silvicultural practices are pruning and thinning. Pruning is an operation carried out at intervals of about two years in order to produce high grade timber free of knots. The operation normally starts at the second year and is completed by about the eleventh year. In each operation, about or slightly more than half of the living crown is removed. The maximum pruning height is about 10m.

Thinning is another silvicultural operation carried out periodically and aimed at removing a certain number of trees so as to allow more space for selected trees forming the final crop. The first thinning is carried out at about the seventh year and subsequent thinnings are carried out in 3 or 4 operations and at intervals of 5 years. The last thinning leaves a final crop of about 250 trees per hectare. Trees from the thinnings are normally sold.

The effects of these silvicultural practices of pruning and thinning on soil and water conservation depends on the species and whether the treatments or operations are carried out as prescribed. When treatments are delayed, as is often the case, the plantations or the stands become over-crowded.

Overcrowded or dense stands of P. patula produce a thick layer of needles which protects the soil and increase infiltration capacity. Properly tended stands of this species also allow plenty of light to reach the floor which results in growth of herbs and shrubs. The presence of layers of dead needles, herbs and shrubs is ideal for soil protection, and well treated P. patula plantations have beneficial effects in conserving soil and water.

On the other hand, an unthinned stand of cupressus lusitanica usually results in a bare floor with mineral soil exposed (Graham, 1949). This condition also occurs in stands which are under-thinned and has contributed to sheet erosion even on gentle slopes. Pruning and thinning plantations of Cu. lusitanica are therefore beneficial for conservation of soil as wood brush from these operations protects the soil. Reduction of crown canopy, particularly during the last thinning, allows the growth of an herbaceous layer and improves conservation of soil and water. As our forests are primarily protective, silvicultural practices in Cypress plantations should also aim at improving the protective function. It may also be necessary to restrict planting of this species to areas with less than 15 per cent average slope.

Harvesting Practices

Clear cutting or clear felling is the normal practice in harvesting forest plantations. The plantations are usually considered mature when they are about 7, 18, 30 and 35 years for fuelwood, pulpwood, saw logs and plywood respectively.

Harvesting operations involve the use of power saws and light or heavy tractors. The use of heavy machinery is becoming more common in areas operated by large mills. This practice causes severe disturbance to the site by exposing the mineral soil as well as causing compaction on logging tracks and landings. Operated areas are normally followed by piling of slash or wood brush and then burning to prepare the site for replanting. The soil is therefore left bare over large areas.

These conditions result not only in loss of nutrient through harvesting and burning, but also in reduced infiltration and direct erosion.

Forest Protection

Forest protection is a major activity undertaken in both natural and plantation forests. The aim is to protect the forests from destruction by fire and other undesirable activities such as grazing and illegal cutting. Fire protection is normally carried out during the dry season. Various measures, including cleaning of fire-breaks, banning of all burning activities, and setting up of patrols in areas of high fire risks, are undertaken.

Although grazing is allowed in forests, it is normally confined to areas with extensive glades. The number of animals allowed to graze are also controlled and those with destructive habits are not permitted in the forests. However, because of shortage of grazing lands in farms adjacent to some forest areas, the livestock population grazing in forest areas has tended to increase gradually. This trend is likely to continue in future and may result in over-grazing.

Fire can easily destroy the herbaceous layer and organic matter which are very important in absorption of impacts of rain drops and reduction of surface runoff. Over-grazing also destroys the herbaceous layer and may leave the forest floor bare or compacted. This results in reduced infiltration, increased surface runoff, and reduced moisture storage (Pereira 1960 and 1962; Wenner, 1980). Forest protection is therefore beneficial for conservation of soil and water.

CONCLUSIONS

Forest management practices affect soil and water conservation in one way or another. While site preparation and clear felling practices have detrimental effects, tending and protection have beneficial effects. In order to improve the protective functions of our forests, the following measures

should be undertaken: shorten the shamba period or possibly undertake anti-erosion work; carry out tending treatments as prescribed giving priority to Cu. lusitanica plantation; control the grazing activity and restrict the use of heavy equipment during harvesting. Finally, research is urgently required to quantify effects of these silvicultural practices. The effect of eucalypts on local water supply also merits urgent investigation.

REFERENCES

- Anon. (1971). Report of the Expert Committee on the effect of large scale planting of blue gum on rainfall in the Nilgris District of Tamil Nadu. Office of the Chief Conservator of Forests, Madras.
- Chavasse, C.G.R. (1969). Compiler: Land preparation for forestry in New Zealand. N.Z. For. Serv. Res. Inst. Symp No. 11
- Forest Department (1939). Squatter and shamba management. Bulletin No. 33
- Graham, R.M. (1949). Undergrowth in forest plantations. Kenya For. Dept. Plantation Management Order No. 9.
- Gosh, R.L. Kaul O.N. and Subba - Rao, B.K. (1978). Some aspects of water relations and nutrition in Eucalyptus plantations. Indian For. 104, 517-524.
- Logie, J.P.W. and Dyson, W.G. (1972). Forestry in Kenya. Government Printer, Nairobi, 23p.
- Logie, J.P.W. (1969). Plantation establishment by shamba system. Kenya For. Dept. Tech. Order No. 48.
- Mathu, J.K.W.(1978). Silvicultural and ecological studies of Kakamega and S. Nandi forests. Kenya For. Dept. Unpublished report.
- Mburu, O.M. (1979). Management of natural forests. Kenya For. Dept. Tech. Order No. 52.
- Nshubemuki, L. and Somi, F.R.G. (1979). Water use by the eucalypts - observations and probable exaggerations. Tanzania Silv. Tech. Note (New Series) No. 44.
- Pereira, H.C. (1960). Forest catchments in Semi-arid country. Kenya For. Dept. Tech. Note No. 76.
- Pereira, H.C. (1962) Compiler: Hydrological effects of changes in land use in some E.African catchment areas, EAAFRD Journal, Special Issue, 27, 131p.
- Pudden H.H.C. (1958). Resident labourers, shamba management, plantation management and practical hints. Kenya For. Dept. Tech. Note No. 55.
- Rodgers, G.D. (1953). The natural occurrence of the eucalypts. Division of Resources and Research. Leaflet No.65 For. and timber Bureau, Australia.

Sessional Paper No. 1 (1968). A Forest Policy for Kenya.
Government Printers, Nairobi.

Taylor, C.D. (1962). Tropical Forestry with particular
reference to West Africa.

Vompersky, S.E. Sokolov, A.A. and Glukhova, T.V. (1981).
Effects of forest and man's economic activities
in small watersheds on stream flow quality. Proc.
of the XVII IUFRO world For Congress, pp. 228-236.

Wanyeki, F.H.M. (1980). Agroforestry practices in high
potential areas of Kenya. Proc. of the Kenya
National Seminar on agroforestry, pp. 287-308.

Wenner, C.G. (1980). An outline of soil Conservation in
Kenya. Soil conservation Unit, Ministry of
Agriculture, 58p.

THE PROBLEMS OF SOIL EROSION AND FERTILITY
MAINTENANCE IN THE TROPICS

By

Samuel K. Mutiso
Department of Geography
University of Nairobi

INTRODUCTION

Perhaps the most challenging problem of the tropical countries to-day is the inadequate food supply to feed the ever-increasing human populations. Two of the major obstacles in soil erosion and the low nutrient status of most of the soils.

The central theme of the current Workshop is to identify and seek solutions to the problems of soil and water conservation. While the author is aware of the difficulties involved when an effort is made to separate these two terms, the current paper addresses itself to the soil erosion and fertility maintenance unless the problems of water conservation and management arise as part of soil conservation. The purpose of this paper is therefore, to examine the above theme in the context of the interrelationship between soil erosion and fertility loss. In other words the paper will assess the extent to which soil fertility changes are dependent upon the erosion process. More attention is paid to erosion and fertility changes in arable land. Nonetheless, the effects of soil erosion on the tropical pasture land will briefly be outlined.

At the outset it is deemed necessary to provide some working definitions for soil erosion and soil fertility. Someone defined soil as rocks on the way to the sea (Brown and Finsterbusch 1972:167). Soil erosion in its simplest sense is the removal of the top-soil by either running water or wind. In this case water erosion is more significant in humid tropics than wind. Steila (1976:10) defines soil fertility as the status of a soil with respect to the amount and availability to plants of the elements necessary for

plant growth. According to Eden (1979:112) 'this term embraces complex reality. To regard it as a single factor in an agricultural situation is convenient, but tends to oversimplify the problem.' To him, fertility cannot be measured in terms of nutrient content only though adequate nutrient capital is important. Nor does the presence of abundant crops necessarily betoken a highly fertile soil, if for instance fertilizers have liberally been used..... soil's real fertility is shown when fertilizer supplements are withdrawn.

EXTENT TO WHICH SOIL FERTILITY LOSS IS DEPENDANT ON SOIL EROSION

The menace of soil erosion is very real in the humid tropics and cannot be underestimated in the discussion of soil fertility and its maintenance. Locally high rural population densities in high and medium potential areas of the tropics have led the people to produce food-crops in areas of high erosion hazard such as the arid and semi-arid regions of Kenya. The transfer of high-potential area crops and the associated agronomic practices to the more delicate and harsher environments has met great failure. The expansion of cropping in these marginal areas has been and still is being handicapped by soil erosion, loss of water as run-off and the subsequent infertile soils. What is carried away will impair the fertility of the eroded area and it cannot be said that eroded soil will be deposited elsewhere as a rich deposit because it takes centuries, sometimes millenia to create an inch of top-soil (which forms the life-sustaining layer) by weathering of rocks (Brown and Finsterbusch 1972:167). Similarly crop growth can be affected by soil erosion because the eroded material tends to be richer in available nutrients than the original soil. The enrichment ratio expresses the relationship between the concentration of nutrients in eroded material and the original soil and is commonly around 2.0 for tropical soils (Moore, 1979:423). It is therefore argued that the loss of crop from erosion is more serious than from disease and when disease is checked a normal healthy plant can be raised, but from soil erosion permanent damage results Eden (1979:99).

Despite the fact that it takes a very long time to create a 'new' layer of top-soil, it is easy to see how in a fraction of time man can destroy this life sustaining layer. When this layer is transported by the agents of erosion such as running water to the sea, it is lost forevermore unless very costly land reclamation processes, typical of the Netherlands, are implemented.

The cause of soil erosion and hence loss of soil fertility can be seen as a function of five important factors, rainfall erosivity, soil erodibility, length and angle of slope, crop or vegetation cover and conservation practice, (Moore 1979:147). The factors responsible for erosion of cultivated land as recorded by Barber et. al, (1979:220) are the erodible nature of the soils, their susceptibility to sealing, the cultivation of annual crops and the distribution of erosive rains.

A major cause of soil erosion is the poor physical properties of the humid tropical soils. Some soils loose structure easily and consequently are more erodible than others. For example Muchena and Van der Pouw (1981:9) state that Luvisols have moderate structure and fertility. They, however have a tendency to form a strong sealing on the surface which leads to low infiltration rates and hence a lot of run-off. Infiltration may be increased by cultivation and mulching. However, it may be decreased by compaction caused by grazing animals. The erodibility of soil is considered an inherent property which depends on numerous hydrologic, textural and structural parameters. Achieving an understanding of how each of these parameters affects erodibility is valuable because it allows predictions of soil susceptibility to erosion with less effort, expense, and time than are required for experimental assessment of either under natural or simulated rainfall (EL-Swanfy (1977:74)).

Rainfall erosivity may cause soil erosion and hence loss of soil fertility. In his assessment of temporal distribution of rainfall erosivity in East Africa, Moore (1979:147,156) found that the 'intensity and kinetic energy parameters show the

highest erosivity hazards to be in Uganda, the Lake Victoria area, parts of the Kenya Highlands and the Coast (R Values of over 400). The lowest erosivity hazards occurred in the drier areas of Kenya and Tanzania (R value less than 150). This is shown on the attached map of the mean annual rainfall erosivity based on the $KE > 25$ parameter for 35 East African stations. Moore adds that 'in this period crop and grass cover is low with much bare soil exposed and few crop management practices are available to increase the cover'.

The occurrence of undesirable soil erosion in humid tropics is largely associated with the removal of soil by intense rainfall after it has been cleared of vegetation. The removal of soil may result in the formation of deep gullies which may link and join and devastate a whole landscape. It may remove the surface soil, without causing gullies to develop, and expose a bare and unfertile sub-soil on which it is difficult for vegetation or crops to develop, and invariably it leads to some loss of the richest part of the soil and carries away plant nutrients and organic matter, reducing to a greater or lesser extent the ability of that soil to produce crops (Ahn 1977: 168). Indeed, Brown and Finsterbusch (1972:168) show how the thinning of the top-layer is a threat to the cities in Western India and how literally millions of acres of cropland in Asia, North Africa, the Middle-East and Central America are being abandoned each year because severe erosion by both wind and water has rendered them unproductive or at least incapable of sustaining the local inhabitants using the existing technologies.

One of the factors which contribute to the removal of vegetation cover is the quest for food in areas of high rural population density. A case in point is the Northern Division of Machakos District, Kenya where densities of 600 people per km^2 exist (Mutiso, 1981:93). To feed these ever increasing populations the land has to be continually cultivated thus exposing it to heavy rains at the beginning of two short rains when the crops are still too young to cover the soil. The end product is soil erosion and soil fertility loss.

Map. I

Mean Annual Rainfall Erosivity in East Africa
(based on the $KE_{15} > 25$ parameter)

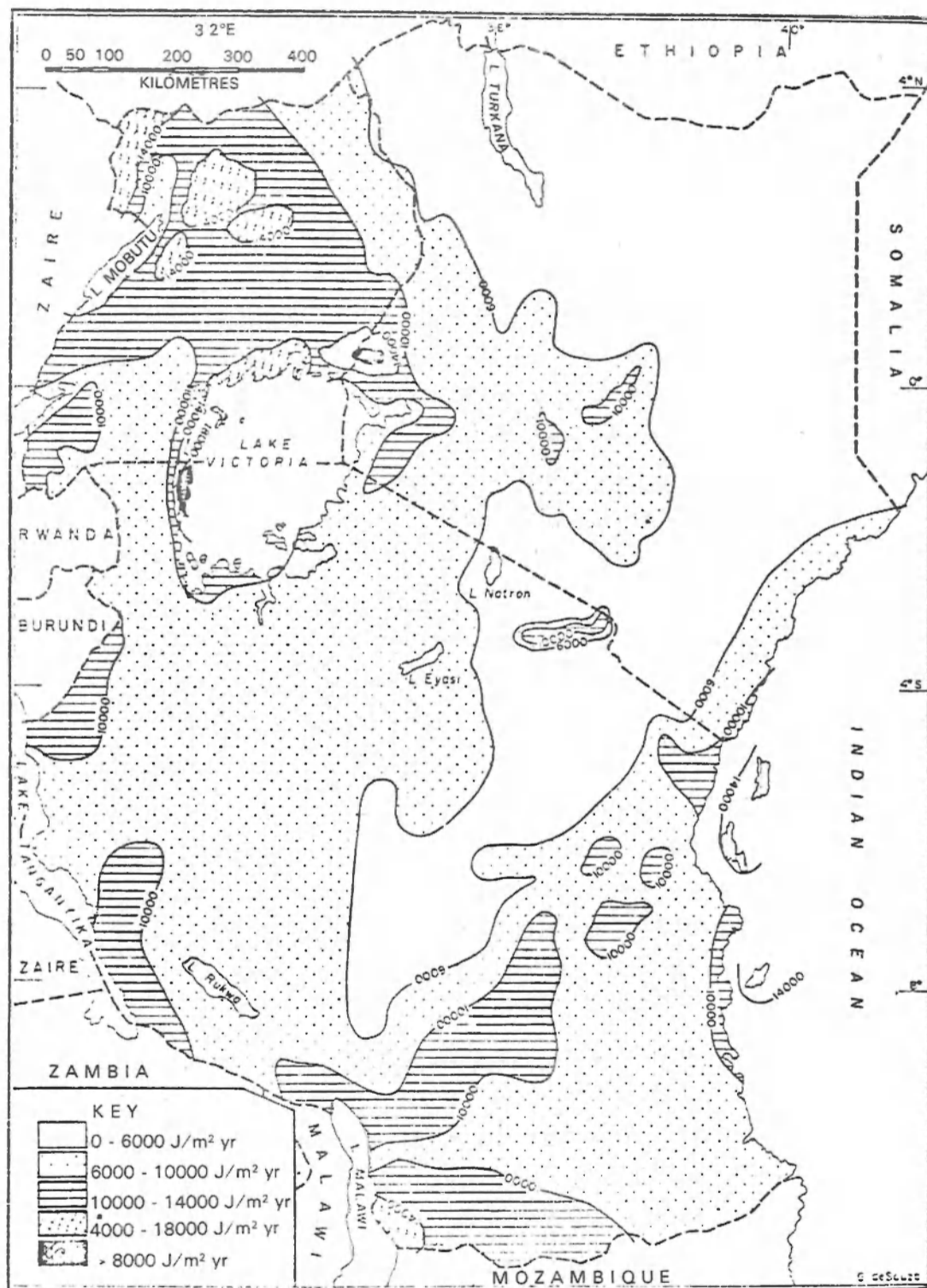

Source: Moore T.R. 1979

EXTENT TO WHICH SOIL FERTILITY LOSS IS DEPENDANT ON SOIL EROSION

Various factors have been advanced to explain the infertility status of most of the tropical soils. Jarret (1977:43) attributes 'the infertile nature of the tropical soils to the high rate of weathering and chemical change under the prevailing warm humid conditions. This encourages the leaching of the bases and of silica, leaving behind a layer rich in iron and aluminium compounds at or near the surface'. He therefore, distinguishes two main types of mature soils: kaolinitic soils formed over acid rocks and ferralitic soils formed over basic rocks. The level of fertility of tropical soils can be determined by the stage of weathering and leaching of the parent rock matter (I.G.U, 1966:20).

In this case, 'the nutrient bases are removed at an early stage and rapidly if the drainage is free and rainfall heavy. The order of loss is $Cl - SO_4 - Ca - Na - Mg - K - SiO_2 - Fe_2O_3 - Al_2O_3$. After the SO_4 stage the soil is base saturated, after K stage the soil is highly acid and kaolinitic, after the SiO_2 stage the soil is gibbsitic and then hematitic. The best tropical soils have not yet reached the kaolinitic stage and are generally derived from basic rocks to start with. As weathering continues, the type of parent material involved becomes less and less important. Fertility rapidly declines after the kaolinitic stage'.

Besides the high rate of weathering and leaching which deprives the tropical soils of their nutrient bases and hence their natural fertility, these soils have weak adsorptive capacities. The low mineral content of these soils and the dominance of kaolinite within their clay fraction give a weak capacity for cation adsorption. By way of contrast, Jarrett (1977:43) states that we may note that clays of temperate latitudes are montmorillonites, hydrated silicates of alumina which allow the penetration of water and which attract such valuable elements as potash, ammonia, lime and magnesia. These adsorptive clays form the basis of many fertile soils. Tropical soils, however, such as the kaolinites and ferralites have lost more of their silica, they cannot easily absorb water, and they

do not easily attract and retain the fertilizing elements mentioned above Jarret, therefore, says (with reference to tropical soils) that 'the high proportion of Kaolinite, quartz 3 grain and hydroxides of both iron and aluminium allow the easy penetration of water and any fertilising elements and humus which is carried by the water in solution is removed. Soils of this nature deteriorate very quickly if they are cultivated.'

A further serious development of soil processes discussed above is the formation of 'laterite.' In a small paper like the present one there is no room to define and present all the controversial theories that have been put forward to explain the factors leading to the formation of laterites. Simply, a lateritic soil is rich in iron and aluminum, low in silica and chemically acid. According to McNeil (1964:3) laterized soils occur commonly in the tropical belt between the latitudes of 30°N and 30°S . Heavy rainfall, high mean annual temperatures and ground water in some cases are the basic cause of laterization. A high mean annual temperature and lack of severe winter season permit sustained bacterial action which destroy plant litter as rapidly as it is produced. Consequently, little, or no humus is found upon the soil. In absence of humic acids the sesquioxides of iron and aluminum are insoluble and accumulate in the soil as yellow or red nodules, and form rocklike layers of laterite (a Latin word meaning 'brick'). High rate of erosion prevalent in the tropics may expose a layer of laterite making the surface unproductive from the agricultural point of view.

In general, laterization results in very low soil fertility because the bases are not held in the soil and humus is lacking. Laterites and lateritic soils are therefore a disastrous handicap to agricultural development in the tropics. To-day they present an obstacle to increasing the food production in many of the third world countries. McNeil (1964:7-8) cites two examples to illustrate this point. She attributes the abandonment of cities by the early civilizations of the Khmer, in Cambodia and Mayas of Central America 'perhaps to the low productivity of the lateritic soils in their old kingdoms.' Secondly, 'Cuba is often cited as a classic example. Long dependent on its great sugar-cane

plantations, the island must contend with a lateritic soil of essentially low fertility that will not produce much more than two successive stands of cane on a given tract. The yields of its plantations will steadily decline unless it finds ways to conserve the island soil'.

Mechanisation in agriculture may also create laterization problem particularly 'deep ploughing of the lateritic soil would probably accelerate leaching and strip the soil of its productivity. The opening up of vast tracts for cultivation in order to make efficient use of tractors and other modern agricultural machinery might lead quickly to the baking of these large expanses into brick by exposing the soil to the action of the sun and wind. It is, therefore, vital to exploit tropical soils with great care.'

THE CONTROL OF SOIL EROSION AND FERTILITY LOSS OF THE TROPICAL SOIL

It will be clear from the fore-going that soil erosion may directly or indirectly contribute to infertility of most tropical soils. Other factors that may lead to fertility loss have already been examined. In sum, the infertility of tropical soils may largely be due to destruction of the humus layer by clearing the vegetation cover through cultivation, burning or erosion. Measures meant to control the factors which lead to soil erosion and soil fertility loss should be given the first priority by all the third world nations.

In order to control erosion on arable lands Hudson (1977:14) rightly concludes that 'of the factors influencing erosion, we can do nothing about erosivity or landform and nothing significant about erodibility, and so control must be achieved through management'. These soil and land management practices according to Lal (1977:81) are based on two broad principles' (i) those practices which help maintain soil infiltration rates at sufficiently high levels to reduce run-off to a negligible amount: and (ii) practices which help disposal of run-off water from the field, should rainfall exceed the infiltration capacity of the soil'. Hence, 'cultural practices

which help maintain a high soil infiltration rate are essentially based on farming techniques which maintain a mulch or live vegetation on the soil such as stubble mulching and no-tillage or minimum tillage, and use of cover crops. The safe disposal of run-off may involve physical manipulation of soil, including land-shaping, construction of contour bunds, terraces, waterways, ridges or tied ridges'. As Lal (1977:94) puts it 'all these are designed to maintain the infiltrability of the soil and decrease run-off and soil loss.' For example, a mulch prevents surface sealing by preventing direct raindrop impact on the soil, and by encouraging enhanced biological activity, which leads to the development of macropores in the soil. His table below show an example of run-off and soil loss under different mulch rates.

The effect of mulch rate on run-off and soil loss on uncropped land at IITA, Ibadan, Nigeria (Rainfall = 61.1 mm).

| Mulch rate (tonnes/ha) | Runoff(%) | Soil loss (tonnes/ha) |
|---------------------------|-----------|--------------------------|
| 0 | 50.0 | 4.83 |
| 2 | 19.7 | 2.48 |
| 4 | 8.0 | 0.52 |
| 6 | 1.2 | 0.05 |

The problem of applying some of the above management practices are highlighted by Barber and Thomas (1979:220). They found out that the use of crop-management practices to control soil erosion is difficult in semi-arid areas, firstly, because of the absence of a crop cover when it is most needed, and secondly, because crop residues are mainly used for animal feed or, if left 'in situ', are consumed by termites. Consequently, mechanical conservation measures are of great importance. Much of the present efforts at conservation has been in building cut-offs and in the construction of steep backslope terraces known locally as 'fanya-juu' terraces.'

In another paper Thomas et al (1980:65) conclude that conservation of both soil and water are of great importance in the arid and semi-arid areas of Machakos District due to the expanding population and increased area of land used for cropping. It is proposed that terraces in these zones **should** be made level and designed to retain run-off. The area and the depth of storage required can be calculated using available data on rainfall intensity, infiltration, terrace spacing and ground slope. Raising the bank periodically to maintain the required storage depth will lead to the development of a bench terrace and spread the area for the absorption of run-off. The method will be most effective where levelling is carried out accurately and slopes are not steep'.

It can be seen that the problem of soil erosion and fertility maintenance in the tropics is very complex. Its solution requires clear understanding and good co-ordination among the planners and the farmers of the tropical countries. The farmers have to be educated in the careful use of the delicate tropical environment if it has to provide food for the present and future generations. However, severe soil erosion is now found not in the arable but pasture land and here is where another challenge lies.

REFERENCES

1. Ahn, P.M., (1977) Erosion Hazard and Farming Systems in East Africa, in Greenland, D.J. and Lal, R. Eds. Soil Conservation and Management in the Humid Tropics, Wiley, New York.
2. Barber, R.G., Thomas, D.B., and Moore, T.R., (1981). Studies on soil erosion and runoff and proposed design procedures for terraces in the cultivated, semi-arid areas of Machakos District, Kenya, in Morgan, R.P.C., Ed., Soil Conservation, Problems and Prospects, Wiley, New York, 219-237.
3. Brown, L.R., and Finsterbusch, G.W., (1972) Man and his Environment: Food, Harper and Row, New York, p. 167.
4. Eden, T., (1979) Elements of Tropical Soil Science, MacMillan, London.
5. El-Swaify, S.A., (1977) Susceptibilities of certain tropical soils to erosion by water, in Greenland, D.J., and Lal, R., Eds. Soil Conservation and Management in the Humid Tropics, Wiley, New York.
6. Hudson, N.W., (1977) The factors determining the extent of soil erosion, in Greenland, D.J., and Lal, R., Eds. Soil Conservation and Management in the Humid Tropics, Wiley, New York.
7. I.G.U. (1966) Savanna/Forest Boundary Symposium, draft copy of proceedings, McGill University Savanna Research Project.
8. Jarrett, H.R., (1977) Tropical Geography Aspect Geographies.
9. McNeil, M., (1964) Lateritic Soils. Scientific American, Nov. 1964, W.H. Freeman and Company.

10. Moore, T.R., (1979) Land use and soil erosion in the Machakos Hills, Kenya, Annals of the Association of American Geographers, 69, 419-431.
11. Moore, T.R., (1979) Rainfall erosivity in East Africa, Geografiska Annaler, 61A, 147-156.
12. Muchena, F.N., and Van der Pouw, B.J.A., (1981) The soil resources of the arid and semi-arid areas of Kenya, paper presented at International Workshop on strategies for Developing the Resources of the Arid and Semi-arid Areas of Kenya, Nairobi.
13. Mutiso, S.K. (1981) Coffee production in Machakos District: a case study of Matungulu Location, thesis submitted in partial fulfilment of requirement for degree of Master of Arts (Agricultural Geography), University of Nairobi.
14. Steila, D. (1976) The Geography of Soils: Formation and Management. Prentice Hall Inc., Englewoods Cliff, New Jersey.

ZERO/MINIMUM TILLAGE IN THE TROPICS -
SOME COMMENTS AND SUGGESTIONS

By

Peter A. Huxley
International Council for Research
in Agroforestry

INTRODUCTION

The comments and reflections set down here arise from a consideration of the results of the first 3 years of field experiments at Morogoro in a semi-arid region in Tanzania, which have been fully described in other papers (Huxley, 1979, 1980). Also from a consideration of the rapidly-growing published information on zero or minimum tillage and the value of plant residues in tropical soils.

In the experiments at Morogoro, on average and over the three years, annual cultivation improved yields overall by about one third, P-fertilizer by some 10% for both maize and legumes and N-fertilizer doubled yields for maize in the first year after clearing, probably because of a high C/N ratio in organic residues (Ahn, 1970), but thereafter gave only minor improvements. Mulch did little in the short term for grain legumes but cereal yields were increased by about a quarter by grass mulching and woody mulch was only slightly less effective. These main effects can be considered as largely additive because the few within-year interactions, although interesting, had only small effects anyway.

At the sites the magnitude of these changes would obviously be different, but it is worth considering the results given here in the light of the incentives they provide for adoption by the farmer because they represent his three primary soil management options.

THE FARMER'S CHOICE

Applying cultivation to 'new' land in the tropics has some obvious advantages. It gives an immediate, short-term yield increase compared with no-tillage. Furthermore, it provides an effective way of clearing weeds; although, in this respect it may ultimately exacerbate the problem by seasonally -turning soil containing dormant but viable weed seeds (Roberts and Dawkins, 1967, Roberts, 1970).

The long-term considerations of tillage versus no tillage are of fundamental importance to the food management of land also. However, they are less likely to influence the tropical peasant farmer's management decisions than immediately-exploitive anti-risk options, even though he knows that repeated seasonal cultivation will usually result in a loss of soil fertility. This process of soil degradation is now well-documented for a range of tropical soils (e.g. Ahn, 1970; Greenland, 1974; Lagermann 1977; Le mare, 1972; Ruthenberg, 1976; Sanchez, 1976) and is considered to be due to the enhanced leaching of soil nutrients, increased loss of organic matter, perhaps itself caused by the deterioration of soil structure (Rovira and Graecen, 1957).

The problem, then, is how to balance short-term incentives against long-term 'investment' practices in the land, assuming that land-tenure is secure?

SHORT-TERM CHOICE AS INFLUENCED BY YIELD INCREASE FACTORS

Even though working within a potential or actual market economy farmers may still retain a basic 'subsistence' approach to decision making (Prior et al, 1978). So that, as long as a family has sufficient land to provide at least a barely adequate food supply in all but disaster years, then the choice is whether or not to use labour and/or, assuming they are available, cash or credit, so as to improve yields per unit area. The comparative magnitude of the incentives for doing this, in various ways may be better understood if

the results of field experiments are presented, additionally, in such a manner as to facilitate comparisons the farmer may wish to make.

Yield Increase Factors

In Table 1 some comparisons of selected treatments have been expressed as 'yield increase factors' (YIF). That is comparing each yield level against that from the poorest set of treatments obtained (usually) by using the fewest inputs. Presenting experimental results in this way, instead of as mean effects, may relate more closely to some measure of the short-term, incentive for adoption. This approach assumes that a farmer is heavily influenced by his need to see some immediate gain from his efforts, and that events of the recent past weigh more with him than future possible trends. The likelihood of a farmer adopting increased inputs in order to achieve improvements in outputs involves many other factors of course (Norman and Palmer-Jones, 1979), but the analysis of these requires considerably more data than that available from a single set of experiments. Even then risk or uncertainty indices (e.g. Zandstra et al, 1979) will not necessarily equate with incentives.

In the experiments at Morogoro the lowest yielding treatment combination was always that without cultivation and mulch but, in 1976 and 1977, plots without applied N were actually better than those with, so that yields from the latter were taken. Furthermore, the experiments were designed to provide sufficient internal replication to assess mean effects efficiently but there were only two replicates of each individual treatment so that data in the table are indicative only. These suggest that, as long as timely-planting and adequate weed and pest control (for the cereals at least) are also adopted, then practicing a combination of tillage, mulching and applying N and P fertilizer at the currently advised rates will, on this soil, give a farmer some three to four times the yield of a maize/legume mixture that he will get without them. However, he can still obtain more than two to three times the lowest

yield even if he does not cultivate, so long as mulch and fertilizer are added and, except in the first year from clearing, the greater proportion of this response will be from added mulch.

The labour requirement for cultivating one hectare might feasibly be anything from 15 to 25 man-days. Cutting, carrying and laying mulch will not be less and it could be more, depending very much on the kind of mulch and the distance of its source in relation to the farmer's plots. In an unplanned system this may be far, and thus militate heavily against the adoption of mulching. The main input for fertilizers will be cash.

There are some other interesting comparisons to make. For example, if the farmer just cultivates, but adds no mulch or fertilizers (treatment D table 1), yields would generally be similar to those where mulch is added without cultivating or using fertilizer (B). Thus, on this soil, mulching and cultivating are roughly inter-changeable in terms of yield response in the short-term. Of particular interest is the situation where cultivation is done only on first clearing the land but not thereafter; a practice which will help eliminate any existing perennial weeds. Then, at least in a three-year initial cycle, and as long as mulch and fertilizer are added annually, yields will be as great or only slightly (about 15%) worse than where the full set of soil management treatments are applied each year (YIFs of 3.3 for both treatment combinations in 1976; and 2.3 and 2.7, respectively, in 1977). Cultivating only in the first year obviates the 'either-or' choice about embarking on zero-cultivation or not and it overcomes the gap in yields in the short-term when introducing zero (or minimum) tillage systems.

Crop Choice

In Experiment 2 at Morogoro (See Huxley, 1980) different cropping schemes were also involved. The worst set of treatments in 1975 was zero-tilled maize without either

fertilizer or mulch (0.344 t ha^{-1}) and the best was sole crop sorghum both mulched and fertilized (2.59 t ha^{-1}), a YIF of 7.5. In 1976 zero-tilled, unmulched and unfertilized sole crop sorghum yielded the poorest (0.30 t ha^{-1}), and sole crop maize with all three soil management treatments the best (3.98 t ha^{-1}), a YIF of 13.4. In 1977 the YIF was 4.5, with the sorghum/cowpea mixture less all three inputs giving the lowest yield (0.83 t ha^{-1}), and cultivated, mulched, sole crop maize the highest (3.76 t ha^{-1}).

In a variable climate, as at Morogoro, and where there is a feasible choice of more than one major crop, choosing the best sole crop in order to maximize cash income from its surplus will be largely speculative unless there are substantial market price differentials, which was not the case here. What is more, a mixed cropping system is more likely to ensure a food supply for the farmer's own use which is greater than the lowest possible sole crop minimum, whether or not it attains the researcher's goal of maximizing overall yield.

The data presented here are comparable with the results of other zero tillage experiments carried out in the tropics with annual crops (e.g. Lal, 1976; Warwick, 1978) where similar yields can be obtained by either cultivating and fertilizing or by not cultivating but using mulch and fertilizers. In a separate adjacent experiment at Morogoro in 1976 Khatibu and Huxley (1979) showed that final grain yield of cowpea was improved only by 26% through cultivation.

Traditional Systems

Minimum tillage per se is, indeed, often widely practised in many parts of East Africa and over 40 years ago Fuggles-Couchman (1939) was advocating breaking away from the 'native' (i.e. minimum tillage) system when he was able to show an average 70% increase in maize yield from deeply-dug land. However, here one should distinguish between breaking 'new' land which is traditionally done by menfolk, and where the digging is carried

out as deeply and as well as can be, from the seasonal re-cultivation prior to sowing, which is often done as one form or another or minimum or zonal tillage, and by the women.

It is now clear that the key to the success of zero- or minimum-tillage systems in the lowland tropics lies in the concomitant use of plant residues (Lal, 1979), unlike the situation in temperate regions (Ellis and Lynch, 1977). Thus, if minimum tillage must be accompanied by mulch or residue-farming to be effective, and this may be all the more important in semi-arid regions, it may be prudent to enquire why it is that peasant farmers generally have not evolved mulch farming systems as a regular activity? Some further aspects of this are discussed in the section on using mulch below.

LONG-TERM OBJECTIVES

A prime reason for proposing zero- or minimum-tillage systems is to promote long-term soil conservation or improvement. In the experiment carried out at Morogoro it is clearly far too early to identify trends accurately because of the large year-to-year variations in yields. In any case, rapid changes in fertility were not to be expected, as the relatively small biomass present when the experiments were laid out was largely removed to the pathways. Changes will be greater, and more rapidly established, where forest soils are being utilized (Sanchez, 1979), or soils under killed sod (Fleige and Baeumer, 1974).

Speculation on Long-Term Trends

Some approximation of trends are needed, however, if any long-term appraisal is to be made of the alternative soil management options open to the farmer. The comparative costs of alternatives such as tilling or not tilling must be estimated over a number of years to be at all meaningful. Information about long-term changes in soil organic matter content, as well as other aspects of soil fertility under different soil management circumstances, is now adequate to establish a hypothesis on the trends likely to occur when tropical soils are managed

in particular ways. Clearly this will still be very conjectural and no substitute for experiments at particular sites, even though these often need be only a very simplified set of treatment comparisons.

Figure I, shows a hypothetical set of curves expressed as changes in yield with time. The addition, or loss, of increments of organic matter is likely to have a diminishing effect (see Ahn, 1979 for discussion) and soil structure is assumed to deteriorate under continued cultivation (e.g. Lal, 1976, 1978) but changes in soil fertility are assumed ultimately to reach an equilibrium. The different cumulative effects on soil fertility of changes in organic matter status, soil structure, and nutrient leaching will cause each set of curves to diverge with time. Even on zero-tilled soils losses of organic matter and nutrients will still occur, although they should be smaller than on tilled soils (e.g. Saunder and Grant, 1962). Initial yield levels for, say, maize are suggested by the overall means from the experimental data given here, assuming additive effects in the short-term, but equal amounts of mulch and fertilizer might well have a greater long-term beneficial effect on untilled as compare to tilled land, as has been indicated above (Lal, 1974a; IITA, 1977).

Other Factors

Experiments with arable crops at the International Institute for Tropical Agriculture, Ibadan, have shown that yields can be maintained, or even improved on some soils in the wet tropics under zero tillage as long as plant residues are added. Probably some 5 to 10 tonnes per hectare of air-dried mulch are needed annually, but, in most cases, applied nutrients will be required eventually also. For example, at Ukiriguru yields of cotton were maintained on a deep sandy loam for 6 years by 3-yearly applications of 15 tons per acre of composted manure. Thereafter, however, applied P and, finally, lime were required to sustain yields (Le Mare, 1972). Of course, adding very large amounts of plant residues to tilled soils can also increase soil fertility (e.g. Robinson and Hosegood, 1965). Clearly, the shape and position of the curves in Figure I will be

influenced by the actual amounts and kinds of mulch or fertilizer applied, as well as by the soil, the climate, the crop grown and the level of other management factors. The reader must, therefore, make the necessary predictive adjustments according to his own circumstances and the data at present available to him.

In Figure I it is assumed that the level of inputs and conditions are such as to actually create a slow improvement in fertility on zero-tilled soils. However, a low compared with a high level of soil management inputs is likely to impose greater year-to-year variability in yields, and soils subjected to zero-tillage without either mulch or fertilizer may be at hazard with regard to erosion, with possibly a calamitous decline in yields.

Such hypothetical trends (which can be updated as and when experimental data become available for any particular site) may be useful to estimate when each yield benefits will accrue for various combinations of treatments i.e. the 'cross-over' points for tilled versus untilled comparisons. However, roughly assessed these may be of help to calculate approximate economic returns under different systems, and so indicate what the farmer's approach may be to 'investing' in any particular set of soil management treatments.

SOME ASPECTS OF USING MULCH

A range of benefits provided by mulch has already been described by Lal (1973, 1975) who showed, experimentally, a 46%, 55% and 22% yield response of maize to mulch in Nigeria over the period 1970 to 1972. Certainly, where there are ready opportunities for a cash income, as from horticultural operations near market outlets (Nganga, 1971), or for cash crops such as Arabica coffee (Robinson and Hosegood, 1965), then mulching has been readily and profitably adopted. Where there is less of a cash incentive, as with arable field crops, some aspects of using mulch need further study.

At the International Institute for Tropical Agriculture, during 1975 and 1976 (IITA, 1976, 1977), mulching with various materials, but especially with legume residues, gave very large yield responses with maize. Mulching with mixed twigs, although at no time giving the best grain yields, nevertheless was an effective material to use. The use of woody materials could well be given greater prominence because they are often more readily available than grasses, for which there is an alternative use where cattle are kept.

Cost/benefits

Assuming farmers are ready to allocate land so as to plant and grow mulch crops the activities of growing, cutting, carrying and spreading mulch can be the most costly set of operations on the farm (see Annual Reports of the Coffee Research Foundation, Ruiru, Kenya). Furthermore where animals are kept mulch farming is less feasible as, usually, all available crop residues and palatable plant material is used for feeding them. Even where residues are left they are only likely to be adequate on many soils if crop growth is encouraged with the aid of costly fertilizers (Legemann, 1977). Again, although mulching can suppress weeds both directly, and indirectly through promoting the vigorous growth of a dominant crop species (i.e. a tall crop), applied inefficiently mulch can sometimes accentuate weed problems. For example weed seeds can be introduced with grassy mulch, and perennial weeds, especially, can thrive in gaps left by woody mulch.

In the short-term, at Morogoro, it does not seem that mulch benefited the grain legume crops to any great extent. Kaul and Sekhon, (1977) have claimed improved N-fixation in the tropics under mulch, resulting in improved yields of soya. At Morogoro, as the mulch was applied after emergence, the legume seedlings were prone to mechanical damage, but the lack of response might also have been due to periods of anoxia caused by waterlogging, as some legumes have been shown to be very sensitive to this (e.g. Field peas: Cannell et al, 1979; Cowpeas: Minchin and Summerfield, 1976; Minchin et al, 1978), and mulch can accentuate anaerobic conditions during rainy periods.

Possible Detrimental Effects

Apart from the well known adverse effects on nitrogen supply due to using mulch with a high C/N ratio, recent work in temperate regions with wheat straw has shown detrimental effects on crop seed germination caused by the adjacent rotting plant residues releasing aliphatic acids, mainly acetic (Ellis and Lynch, 1977). This is unlikely to have been a factor in the Morogoro experiments as mulch was laid after seedling emergence, and the previous year's residues were not obvious. The lower seedling emergence figures on mulched plots suggest, therefore, possible microbial suppression (Lynch, 1978). Where cultivars with known low seedling vigour are used (Heydecker, 1961) this could become important.

There may be other adverse factors militating the more widespread use of mulch. The most prolific source available in many parts of Africa, either in woodland or savanna regions, is from bush. But woody mulch is not particularly easy to lay in mixed cropping systems without damaging growing plants. Additionally, the extent to which plant residues encourage rodents and snakes is a fact that should be considered.

One long-term aspect of mulch that requires more study relates to its effects on changing the kinds and numbers of soil fauna present. Non-cultivated soils have a smaller total pore space in the top layers but a greater continuum of pores at depth (Ellis et al, 1976; Goss et al, 1978), and the latter may often be the result of increased activity by soil fauna. In temperate soils earthworms and arthropods play an important role in improving the structure of direct-drilled soils (Edwards and Lofty, 1978) and similarly in the tropics (Lal, 1976). But termites can also play a prominent part in creating soil channels (e.g. Huxley and Turk, 1875). Termites can, however, attack living plants, as they did to a small extent at Morogoro, and this had been noted elsewhere, especially for the Macrotermitinae (Roy-Noel, 1979). Clearly this needs further study.

SOME OTHER CONSIDERATIONS

Seedling Emergence

If equipment which compacts soil is used to sow seeds in minimum tillage systems than this can, of course, affect seedling emergence (Hegarty and Royle, 1978; Knittle and Burris, 1979). However, at Morogoro, a pointed implement was used to hand sow seeds which were, therefore, even in zero-tilled soil, covered only loosely. Germination and emergence were affected adversely only in those years when seeds were subjected to intermittent drying and wetting (Fig. 2). In tropical no-till systems sowing needs to be delayed until there is a likelihood of frequent showers (MaCartney and Northwood, 1971; Huxley, 1979a), but not so delayed as to suffer late-planting effects (e.g. for maize: Lal, 1973; Cooper, 1974, 1975: for cotton; Rijks, 1967).

Seedling Growth

Another crucial stage is early seedling growth (Drew and Goss, 1973). Although plants can recover to some extent from shortage of nutrients or light in the early growth stages, they seem less able to do so if subjected to water stress at this time (e.g. Cowpea, Summerfield et al, 1976). Cannell (1977) has recently reviewed the effects of soil compaction on plant growth but there is still only scanty information concerning tropical crops and soils. Clearly, the stress physiology of tropical crop plants being grown in no-till systems needs to be looked into.

Zero-Tillage in Arid Regions

Zero-tillage, or direct-drilling, has generally been less successful in temperate regions on poorly-drained as compared with well-drained soils. In tropical climates its potentials need to be more fully explored in seasonally-arid regions. Some investigations in arid areas on sandy soils, which might appear to be very suitable for minimum tillage systems, have shown poor results. For example Shaalan et.al., (1977) found zero-tillage to give only 1.58 t ha^{-1} of winter wheat at

Tripoli compared with 5.50 t ha^{-1} where the soil had been disc-ploughed. Similarly, at Kufra, maize yields were considerably reduced by zero-tillage (Sorour et al., 1975). In these desert soils compacted stratified layers can occur.

Zero-Tillage with Reference to Water Status and Fertilizer Practices

Reduced tillage does not necessarily subject the growing plant to a more adverse water status. For example, with cotton, Young and Browning (1977) found, over four years, that plant water potentials were generally more negative on deep-rather than shallow-tilled soil, and Lal et al., (1978) showed that zero-tillage with plant residues provided greater soil water reserves, with concomitant effects on the yields of maize and cowpea, compared with tilled soil.

Fertilizer practices may need amending with zero-or minimum-tillage systems. Although, recent studies in the UK (Ellis et al., 1978) have shown no differences in response of wheat to applied N on tilled or no-tilled soils, the results were somewhat variable. There is evidence, for barley, that the localised application of P fertilizer only to a part of the root system does not inhibit growth, as long as the fertilizer is applied near to the stem. However, localised application of No_3 - may inhibit root elongation (Drew and Saker, 1977).

Less lodging occurred on P-fertilized maize plants at Morogoro probably, as Kang and Yanusa (1977) have shown in Nigeria, because root density is increased by applied P. In their experiment the addition of 160 kg N ha^{-1} equalized yields on strip-tilled and overall-tilled plots.

Results at the International Institute for Tropical Agriculture, Ibadan, have shown an improved response to N-fertilizer on untilled as compared with tilled land (Lal, 1974b, IITA, 1977). At Morogoro there were, in these first 3 years, no consistent interactions between tillage and applied fertilizers.

Zero-Tillage and Perennial Crops

The cost of mulching is often well repaid in both yield and quality with high value tropical perennial crops, as over 20 years of experimental results with arabic coffee in Kenya show well (see Reports from the Coffee Research Station, Ruiru, Kenya). Certainly with this crop, zero-tillage combined with mulch and the use of herbicides has been shown to be a viable system (Mitchell, 1974). Where very close-planted intensive systems are used, as with tea, or more recently with coffee, the crop tends to be self-mulching and tillage is not feasible anyway.

ZERO-OR MINIMUM TILLAGE AND AGROFORESTRY

There is now growing concern over the decreasing productivity and environmental damage being caused by present-day shifting cultivation practices. In this respect zero-or minimum tillage techniques offer considerable promise in extending the agricultural phase in such systems (Greenland, 1975). No-tillage can also be advantageously combined, especially on sloping land, with the growing of leguminous cover crops in the pre-cropping phase of shifting cultivation so as to raise soil fertility (Kannegieter, 1967; Lal et al, 1978).

Whether one is concerned with protecting fragile environments (King, 1979), or reversing the less spectacular but more insidious on-going degradation of existing relatively high-potential arable land in the tropics, there is a growing awareness that multiple land-use systems involving not only seasonal crops but also trees and/or shrubs (agroforestry systems) can help combine sustained productivity with land conservation.

Even where such systems are static, and utilize either zonal or mixed cropping schemes (Huxley, 1979b), the possible benefits of zero-tillage/mulching techniques must not be overlooked. In these circumstances the most readily available form of mulch is likely to be woody residues. This has an added advantage in that nutrients in organic matter can be transferred

from one part of the system, without degrading it so as to enrich another. This is because particularly in arid and semi-arid regions, and even on poor soils and when lopped for fodder regularly, woody perennials can provide a relatively more stable biomass than forbs or grasses.

Multi-Purpose Trees/Shrubs

If multi-purpose woody species are used in the system so as to provide not just mulch but also fuelwood, food (fruits and seeds) fodder and other products (King, 1979, Chandler and Spurgeon, 1980) then there could well be a greater likelihood of farmers adopting zero-tillage plus mulch practices along with these other benefits. This would especially be the case if the spatial arrangements of such multiple land use systems was carefully planned so as to minimize the labour required to collect the mulch and, at the same time, to take into account the added potential of the woody perennial vegetation in terms of shelter, soil erosion control, and climatic amelioration.

A number of multi-purpose tree species, suited to various environments, are now being actively studied, e.g. Leucaena, Prosopis, Brosimum, Azadirachta Cassia spp., Acacia spp. and others (Burley, 1979; Nat. Acad. Sci., 1975, 1977, 1979).

The need to obtain multiple benefits whilst also conserving soil fertility has resulted in many types of indigenous agroforestry systems arising spontaneously (de las Salas, 1979; Chandler and Spurgeon, 1980; United Nations University, 1980). There is, however, no easy recipe for such a complex mix and Openshaw and Moris (1980) have discussed some of the problems of actively promoting multiple land-use systems involving woody perennials. Similarly, and even although such practices have been technically proven, zero-tillage/mulch farming will not necessarily be adopted by farmers if the whole 'package' is not right.

A key factor is to associate relatively short-term incentives with long-term 'investment' practices. In this respect, in low input systems, zero-tillage is only likely to be successful, particularly where edible crop residues are normally made available to animals, if adequate material for mulching is available close to the cropping area. Agroforestry systems in which multiple benefits are obtained from fast-growing woody species, some parts of which (small branches and twigs) can be used for mulch, may then serve to bridge the 'incentive gap' to undertake sound long-term soil management in the tropics. Perhaps a way to start is by using zero-tillage/woody mulch on a part of the farm only, according to the supply of mulching material available.

CONCLUDING THOUGHTS

Three major changes have come about in our approach to tropical land-use in recent years. Intercropping is now accepted as not only a respectable way for a farmer to minimize risks but, in many situations, to actually maximize returns. Zero-or minimum tillage is beginning to seem a sound soil management practice on many soils in the high-rainfall lowland tropics, and its place in semi-arid areas is also arousing interest. Finally, we are now realizing that the rural populations in many parts of the tropics have long been aware of the benefits which accrue from having trees or shrubs in their farming systems - and a wide range of what can be termed agroforestry enterprises, arising from indigenous activities, are to be found throughout the tropics.

What we need now, if we are to speed the development of sound and productive tropical land-use in areas where existing systems are known to be inadequate, is a strategy which can, if necessary, encompass all three approaches. Clearly, this must be based on, yet remain untrammelled by, our past experiences, and it will require some very broadminded scientific practitioners to explore appropriate tactics.

REFERENCES

- Ahn, P.M. 1970. West African Soils. Oxford University Press, London.
- Ahn, P.M. 1979. 'The optimum length of planned fallows' Soils Research in Agroforestry. Mongi, H.O. and Huxley P.A. (Eds.) ICRAF, Nairobi.
- Burley, J. 1979. 'Choice of tree species and possibility of genetic improvement for smallholder and community forests.' Proc. United Nations University/Chiang Mai University Workshop on agroforestry for rural communities, Chiang Mai, Thailand, 12-16 November, 1979. - in the press.
- Cannell, R.Q. 1977. 'Soil aeration and compaction in relation to root growth and soil management' appl. biol. 2. 1-86.
- Cannell, R.Q. Gales, K.; Snaydon, R.W. and Suhail, B.A. 1979. 'Effects of short-term waterlogging on the growth and yield of peas (Pisum sativum)'. Ann. appl. Biol. 93, 327-335.
- Chandler, M.T. and Spurgeon D. (Eds.) 1980. Proc. of (ICRAF/DSE Conf. on International Co-operation in Agroforestry), ICRAF, Nairobi.
- Cooper, P.J.M. 1974. Soil temperature under maize and bare fallow in Western Kenya, in Proc. Fifth Eastern Afr. Cereals Res. Conf. Malawi, March 10-15, 1974 (Ed. D.R.B. Manda) Government Printer, Zomba, pp. 182-190.
- Cooper, P.J.M. 1975. 'Studies on the soil atmosphere composition under maize, grass and bare fallow in Western Kenya'. E.A. agric. For. J. 40. 313-331.
- Drew, M.C. and Goss, M.J. 1973. Effect of soil physical factors on root growth. Chemistry and Industry, pp. 679-684.
- Drew, M.C. and Saker, L.R. 1977. Effect of the supply of inorganic nutrients on root growth and ion uptake in cereals in Agric. Res. Council Letcombe Lab. (U.K.) A.R. 1976, pp. 21-24.
- Edwards, C.A. and Lofty, J.R. 1978. The influence of arthropods and earthworms upon root growth of direct-drilled cereals J. appl. Ecol. 15, pp. 789-795.
- Ellis, F.B. Elliot, J.G., Barnes, B.T. and Howse, K.R. 'Comparison of direct drilling, reduced cultivation and ploughing on the growth of cereals 2. Spring barley on a sandy loam soil: soil physical conditions and root growth'. J. Agric. Sci.

- Ellis, F.B., Christian D.G., and Graham, J.P. 1978. Effect of method of cultivation on the nitrogen requirement of winter wheat on clay soil, in Agric. Res. Council Letcombe Lab. (U.K.) A.R. 1977, pp. 45-46
- Ellis, F.B. Lynch, J.M. (1977). ARC (U.K.) Research Review 3, 39 U.K.
- Fleige, H. and Baemer, K. 1974. 'Effect of zero-tillage on organic carbon and total nitrogen content, and their distribution in different N-fractions in loessial soils.' Agro-Ecosystems 1, pp. 19-29.
- Fuggles-Couchman, N.R. 1939. 'Green manurial and cultivation trials made at Morogoro, Eastern Province, Tanganyika Territory. E. afr. agric. J. 5, pp. 208-210.
- Goss, M.J., Douglas, J.T., Howse, K.R., Vaughan-Williams, J.M. and Ward, M.A. 1978. 'Effects of cultivation and soil physical conditions,' in Agric. Res. Council Letcombe Laboratory (U.K.) A.R. 1977, pp. 37-41.
- Greenland, D.J. 1974. 'Evolution and development of different types of shifting cultivation,' in shifting cultivation and soil conservation in Africa. FAO Soils Bulletin No. 24. FAO, Rome, pp. 5-13.
- Greenland, D.J. 1975. 'Bringing the green revolution to the shifting cultivator.' Science, 190. 841-844.
- Hegarty, T.W. and Royle, S.M. 1978. Soil impedance as a factor reducing crop seedlings emergence and its relation to soil conditions at sowing and to applied water.' J. Appl. Ecol. 15, 897-904.
- Heydecker, W. 1961. 'The emergence of vegetable seedlings as a standard test of soil quality' in Advances in Horticultural Science and their Applications, vol. 1. Pergamon, Oxford, pp. 381-392.
- Huxley, P.A. 1979a. 'Zero-tillage at Morogoro, Tanzania' in Soil physical conditions and crop production in the tropics, Lal, R. and Greenland, D.J., Eds., John Wiley.
- Huxley, P.A. 1979b. Classification of plant aspects of agroforestry systems. ICRAF, Nairobi (mimeo).
- Huxley, P.A. 1980. Zero-tillage at Morogoro, Tanzania. II. Summary of crop yields over the first 3 years (1975-1977).
- Huxley, P.A. and Turk, A. 1975. 'Preliminary investigations with Arabica coffee in a root observation laboratory in Kenya.' E.A. agric.For. J. 40, 300-312.
- International Institute for Tropical Agriculture. 1976. Annual Report, 1975, IITA, Ibadan.

- International Institute for Tropical Agriculture, 1977 in Annual Report 1976, IITA, Ibadan, pp. 82-85. Annual Report.
- Jackson, M.B. 1979. 'Rapid injury to peas by soil waterlogging.' J. Sci. Food Agric. 30, pp. 143-152.
- Kang, B.T. and Yanusa, M. 1977. 'Effects of tillage methods and phosphorus fertilization on maize in the humid Tropics.' Agron. J. 69, pp. 291-294.
- Kannegieter, A. 1967. 'Zero cultivation and other methods of reclaiming Pueraria fallowed land for food crop cultivation in the forest zone of Ghana.' Trop. Agriculturist. 123, pp. 51-73.
- Khatibu, A.I. and Huxley, P.A. 1979. Effects of zero cultivation on the growth, nodulation and yield of cow pea (Vigna unguiculata) at Morogoro, in Soil physical conditions and crop production in the tropics Lal, R. Greenland, D.J. Eds. John Wiley.
- King, K.F.S. 1979. 'Agroforestry and the utilization of fragile ecosystems.' Forest Ecology and Management 2, 161-168.
- Knittle, K.H. and Burris, J.S. 1979. Soybean hypocotyl growth under field conditions. Crop. Sci. 19, 37-41.
- Lagemann, J. 1977. Traditional African farming systems in Eastern Nigeria: an analysis of reaction to increasing population pressure. Munchen: Weltforum-Verlag (Afrika-Studien: Nr. 98).
- Lal, R. 1973. 'Effects of seed bed preparation and time of planting on maize (Zea mays) in Western Nigeria.' Expl. Agric. 9, pp. 303-313.
- Lal, R. 1974a. 'No-tillage effects in soil properties and maize (Zea mays L.) production in Western Nigeria.' Plant and Soil, 40, pp. 321-331.
- Lal, R. 1974b. 'Soil temperature, soil moisture and maize yield from mulched and unmulched tropical soils.' Plant and Soil, 40, pp. 129-143.
- Lal, R. 1975. Role of mulching techniques in tropical soil and water management. Tec. Bull. No. 1, 37. IITA, Ibadan.
- Lal, R. 1976. No-tillage effects on soil properties under different crops in Western Nigeria. Soil Sci. Soc. of America, Proc. 40, 762-768.
- Lal, R. 1977. No-tillage system and residue requirement. FAO/UNDP Conf. on Organic Re-cycling, 6-12 December, 1977, Beau, Cameroon.

- Lal, R. 1978. 'Influence of tillage methods and residue mulches on soil structure and infiltration rate.' in Modification of Soil Structure, Emerson, W.W. Bond, R.D. and Dexter, A.R. Eds. John Wiley, Chichester, U.K., pp. 393-402.
- Lal, R. 1979. 'Effects of cultural and harvesting practices on soil physical conditions.' in "Soils Research in Agroforestry" Mongi, H.O. and Huxley, P.A. ICRAF, Nairobi, pp. 327-351.
- Lal, R., Maurya, P.R. and Osei-Yeboah, S. 1978. 'Effect of no-tillage and ploughing on efficiency of water use in maize and cowpea.' Expl. Agric. 14, pp. 113-120.
- Lal, R., Wilson, G.F. and Okigbo, B.N. 1978. 'No till farming after various grasses and leguminous cover crops in a tropical alfisol I. Crop Performance.' Field Crops Research, 1, pp. 71-84.
- Le Mare, P.H. 1972. A long-term experiment on soil fertility and cotton yield in Tanzania. Expl. Agric. 8, pp. 299-310.
- Lynch, J.M. 1978. 'Microbial interactions around seeds.' Ann. Appl. Biol. 89, pp. 165-167.
- McCartney, J.C. and Northwood, P.J. 1971. 'The effect of different cultivation techniques in soil moisture conservation and establishment and yield of maize at Kongwa, Central Tanzania.' Trop. Agric. (Trinidad), 48, pp. 9-23.
- Minchin, F.R. and Summerfield, R.J. 1976. Symbiotic nitrogen fixation and vegetative growth of cowpea (Vigna unguiculata (L.) Walp.) in waterlogged conditions. Plant and Soil, 45, pp. 113-127.
- Minchin, F.R., Summerfield, R.J., Eaglesham, A.R.J. and Stewart, K.A. 1978. 'Effects of short-term water-logging on growth and yield of cowpea (Vigna unguiculata).' J. Agric. Sci. Camb. 90, pp.355-366.
- Mitchell, H.W. 1974. Weed control methods compared over a four year period in Kenya Coffee. Kenya Coff. 39, pp. 50-59.
- National Academy of Sciences, 1975. Underexploited tropical plants with promising economic value. Washington, D.C.
- National Academy of Sciences, 1977. Leucaena: promising forage and tree crop for the tropics. Washington, D.C.
- National Academy of Sciences. 1979. Tropical legumes: resources for the future. Washington, D.C.
- Ng'ang'a, S. 1971. Physiological and cultural investigations into fresh market tomatoes in Kenya. Ph.D. Thesis, Makerere University, Uganda.

- Norman, D.W. and Palmer-Jones, R.W. 1977. 'Economic methodology for assessing cropping systems,' in Symp. on Cropping Systems Research and Development for the Asian Rice Farmer. IRRI, Los Banos, pp. 241-259.
- Openshaw, K. Morris, J. 1980. 'The socio-economics of agroforestry,' in Proc. of ICRAF/DSE Conf. on International Co-operation in Agroforestry. ICRAF, Nairobi.
- Prior, A., Vernon, D., Parker, J.H.M., Bbenkele, E., Kean, S. and Collinson, M. 1978. Demonstrations of an interdisciplinary approach to planning adaptive agricultural research programmes. Government of Zambia/University of Zambia/CIMMYT. Rep. No. 3. CIMMYT Eastern Africa Economics Programme, CIMMYT, Nairobi.
- Rijks, D.A. 1967. 'Optimum sowing date for yield, a review of work in the BP. 52 cotton area of Uganda.' Cotton Grow. Rev. 44, p. 247.
- Roberts, H.A. and Dawkins, P.A. 1967. 'Effect of cultivation on the numbers of viable weed seeds in soil.' Weed Research, 7, pp. 290-301.
- Roberts, H.A. 1970. 'Viable weed in cultivated soils' in Rep. Natn. Veg. Res. Stn. for 1969, Wellesbourne, U.K. pp. 25-38.
- Robinson, J.B.D. and Hosegood, P.H. 1965. 'Effects of organic mulch on fertility of a latasolic coffee soil in Kenya.' Expl. Agric., 1, pp. 67-80.
- Rovira, A.D. and Greacen, E.L. 1957. 'The effects of aggregate disruption on the activity of microorganisms in the soil.' Austral. J. agric. Res. 8, pp. 659-673.
- Roy-Noel, J. 1979. 'Termites and soil properties in Soils Research in Agroforestry' Mongo, H.O. and Huxley, P.A. Eds. ICRAF, Nairobi, pp. 271-295.
- Ruthenberg, H. 1976. Farming systems in the tropics, 2nd ed. Clarendon Press, Oxford, 1976.
- de las Salas, Gonzalo, 1979. Proc. of a Workshop on agroforestry systems in Latin America. Turrialba, March 26-30 1979. CATLE' Turrialba, Costa Rica.
- Sanchez, P.A. 1976. Properties and management of soils in the tropics. Wiley, New York.
- Sanchez, P.A. 1979. 'Soil fertility and conservation considerations for agroforestry systems in the humid tropics of Latin America.' in Soils Research in Agroforestry. Mongi, H.O. and Huxley, P.A. Eds. ICRAF, Nairobi, pp. 79-124.

- Shaalan, M.I., Chaudry, N.S. and Sorour, F.A. 1977. The effect of tillage and planting methods on growth, weed population and yield in semi-dwarf wheat (*Triticum aestivum* L.). Dept. Plant Prod., Fac. Agric., p. 24, El Fatah University, Tripoli. mimeo.
- Sorour, F.A., El-sharkarway, M.A. and Shazli Osman, M. 1975. 'Influence of tillage methods on growth and yield of corn (*Zea mays* L.),' Libyan J. Agric., 4, pp. 47-50.
- Summerfield, R.J. Huxley, P.A., Dart, P.J. and Hughes, A.P. 1976. Some effect of environmental stress on seed yield of cowpea (*Vigna unguiculata* (L) Walp) CV. Prima. Plant and Soil, 44, pp. 527-546.
- Saunders, D.H. and Grant P.M. 1962. Rate of mineralization of organic matter in cultivated Rhodesian Soils, in Trans. internat. Soil Science Soc. (Commissions IV and V) New Zealand pp. 235-239.
- United Nations University, 1980. Proc. of a Workshop on agroforestry for rural communities. Chiang Mai, Thailand, November, 1979. United Nations University, Tokyo (in the press); pp. 12-16.
- Warwick, D.A. 1978. 'Reduced tillage research with maize (*Zea mays*) in Swaziland.' J. Roy. Swaziland Soc. (Sci. and Tech.), 1, pp. 155-163.
- Young, R.E. and Douglas Browning, V. 1977. 'Cotton leaf water potential and yields relative to tillage and traffic.' Trans. Amer. Soc. agric. Eng., 20, pp. 673-682.
- Zandstra, H. Swanberg, K. Zulberti, C. and Nestel, B. 1979. Chapter II 'Risk' in Caqueza: living rural development, IDRC, (1970), Ottawa. pp. 195-208.

Table I: Maize/Legume Crops Showing Yield Increase Factor
(x lowest yield obtained)

| <u>Treatment</u> | <u>1975</u> | <u>1976</u> | <u>1977</u> |
|--|-------------|-------------|-------------|
| <u>ZERO-TILLED</u> | | | |
| A. N + P and Mulch | 3.09 | 2.97 | 2.14 |
| B. Mulch only | 1.53 | 2.44 | 1.79 |
| C. N + P and Mulch but tilled 1975 only | - | 3.31 | 2.31 |
| <u>CULTIVATED</u> | | | |
| D. Without fertilizer or mulch | 1.75 | 1.76 | 1.82 |
| E. N + P and Mulch (woody) | 3.79 | 3.13 | 2.37 |
| F. N + P and Mulch (grass) | 4.14 | 3.27 | 2.73 |
| <hr/> | | | |
| Actual yield of (F) (kg ha ⁻¹) | 3421 | 3797 | 4136 |

Calculated from data obtained in a zero-tillage
experiment at Morogoro, Tanzania (Huxley, 1980a).

Figure I: Explanatory Note

This diagram shows hypothetical changes in soil fertility with time under different soil management treatments expressed in yields of, say, maize. Solid lines indicate changes when the soil is cultivated annually, dashed lines are with zero-cultivation. Each set of curves is for no additional inputs (nil), with added mulch (M), or fertilizer (F), or both (+F+M). If higher levels than say, 5 to 10 tons of mulch per annum were used, and greater amounts of fertilizer than the recommended rates for optimising grain yield economically, then the increase in plant residues will change the origins and shapes of the response curves. That is those in each set will start further apart and cultivated soils will lose fertility more slowly, and uncultivated soils gain it more rapidly, than as originally shown.

Soils under zero-tillage with no mulch and/or fertilizer added are susceptible to erosion, especially if the land is sloping, and depending on initial fertility and the amount of crop residues left behind each season. This particular treatment is shown, therefore, as resulting in a range of fertility changes (within the hatched area) depending on circumstances.

Although the initial points are suggested by the results of the experiments carried out at Morogoro this will clearly be different for other sites, as will the rates of change in fertility relative to one another and their final differences. The purpose of the diagram is to encourage comparisons, where these can be made and, where they cannot because of lack of data, to help suggest simple experiments to obtain them.

FIG. 1 Hypothetical changes in soil fertility with time under different soil management treatment

F — Fertiliser M — Mulch (see explanatory note)

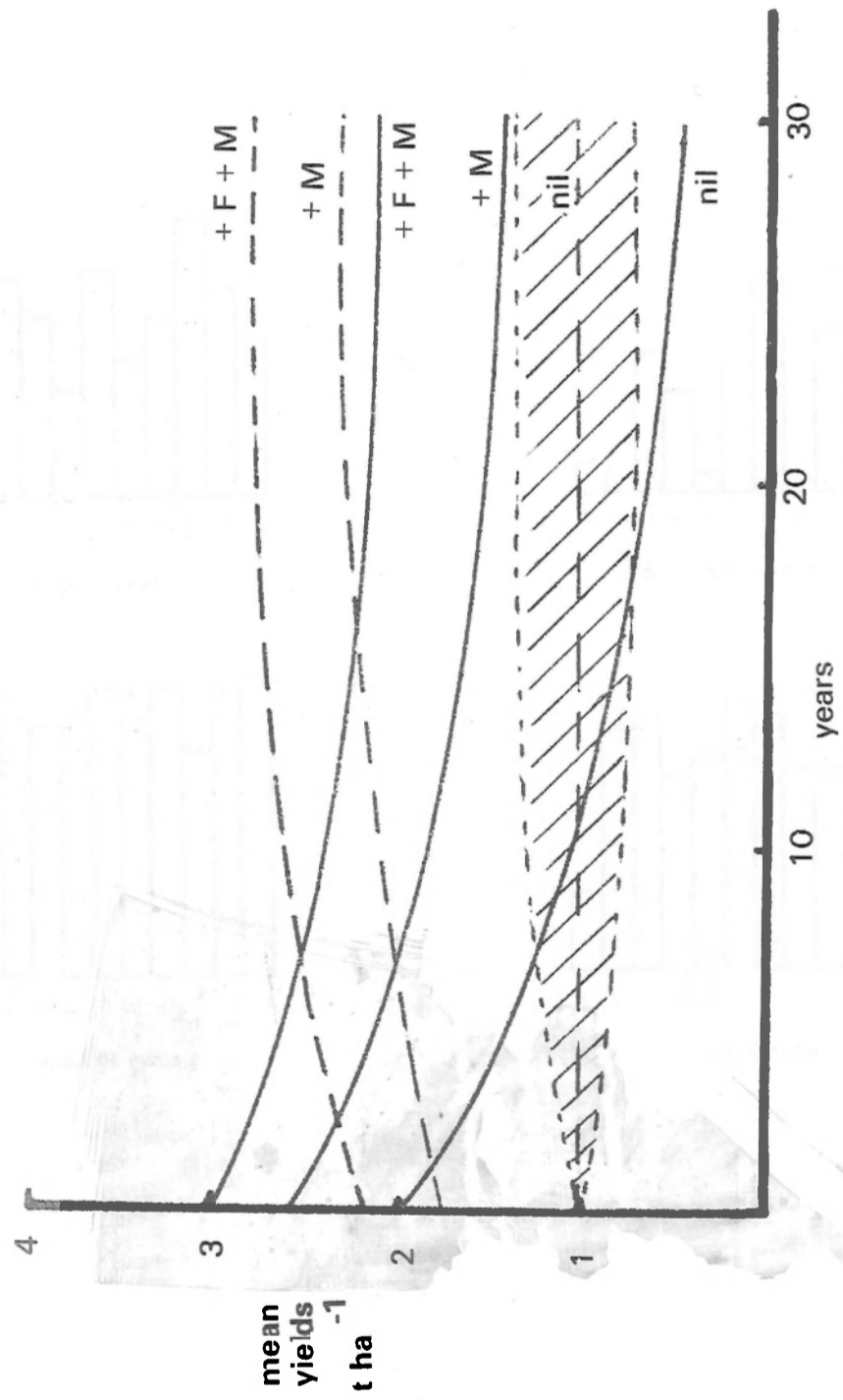
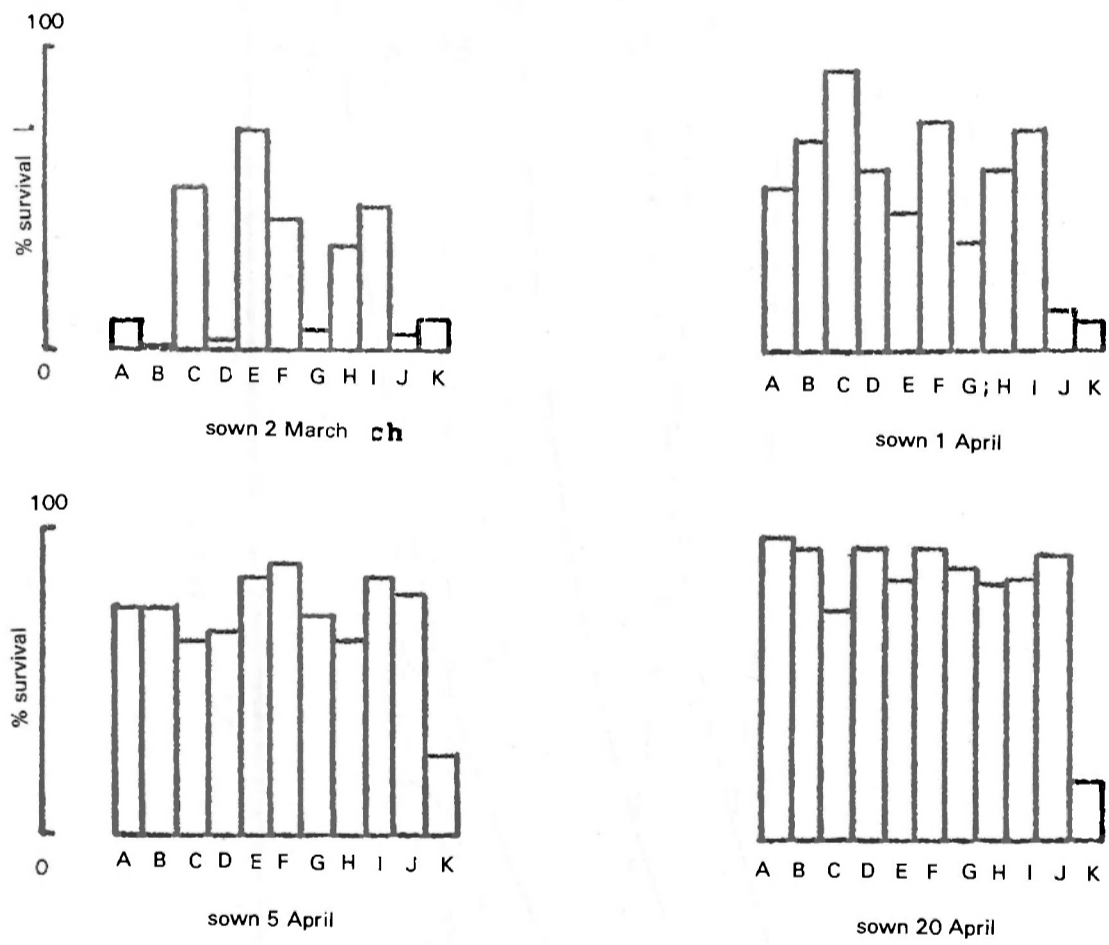

FIG. 2: Zero Cultivation Emergence/Survival Trial. 1976. Approximately three seeds sown per hole in 10 holes (replicated twice) on the four dates shown. Survival recorded on the 11 May 1976 as positive if any healthy seedling had survived at each hole. Crops used were A. sunflower, B. cowpea, C. pearl millet, D. soya, E. simsim, F. green gram, G. maize, H. sorghum, I. pigeon pea, J. Field beans (*Phaseolus vulgaris*) and K. *Amaranthus hybridus*, (local 'spinach').



CONSERVATION TILLAGE IN SEMI-ARID AREAS OF KENYA

By

G. Muchiri and F.N. Gichuki
Department of Agricultural Engineering
University of Nairobi.

INTRODUCTION

The traditional system of tillage for semi-arid regions characterised by the animal drawn Ard or Desi plough has been practised for over 4000 years in the Middle East and East Asia (Anderson, et al, 1980). The tillage process involves several runs with the metal pointed tool to loosen the top 5 cm of the soil. This process loosens the soil without turning the furrow, undercutting all weeds and plants but leaving them on the surface as mulch provided the weather is dry. It becomes a ready seedbed when the rain falls. According to Russell (1961) the modern conservation tillage characterised by chisels, A-shares or duckfoot shares powered by large tractors in broad cultivations of Western United States and Australia is based on the same principle of surface soil loosening without turning over subsoil or burying the trash. This is primarily to minimise surface runoff and evaporation thus enhancing soil and water conservation. The high power requirements to achieve an economic rate of work make the modern system inappropriate for many small holders in semi-arid regions.

From the available literature, it seems that the traditional system of tillage has prevailed for so many years because of lack of an appropriate alternative system of tillage. Thus although scientists have learnt from the traditional system to modernise dry land tillage technology, they have not done enough to adapt the modern technology to suit the cultural and socio-economic environment of the small farmers. This failure has most probably occurred due to lack of an interdisciplinary

approach in defining and in solving the problems of small farmers. Recent work by All-India Co-ordinated Dry-land Project (Anderson, 1980), and ICRISAT (1979) was aimed at solving this problem. Anderson (1980) has reported that equipment innovations based on existing equipment are more likely to be adopted. On the other hand the basic tool, Tropiculteur, recommended by ICRISAT, was developed in France and costs US\$ 600 compared to US\$ 30 spent on the traditional set (ICRISAT, 1979). Although the ICRISAT system ensures full utilisation of soil and water and available animal power it needs scaling down to what the farmer can afford.

Conservation of moisture is of utmost importance in arid and semi-arid areas to ensure crop production and rain and wind erosion control. This could be achieved by the following methods: increasing infiltration, reducing evaporation, weed control, terracing, and strip cropping. Tillage determines the extent to which soil and water can be conserved through its effect on time of seedbed preparation, resulting surface roughness, mulch retained on the surface and aggregate size and stability. ICRISAT (1979) has established the relative advantage of narrow furrow and ridge in terms of soil and water conservation. At Katumani, M'Arimi (1977) quantified the relative advantage of tied ridges over flat cultivation in terms of water conservation and relative crop yields. The main soil conservation structures in Machakos District are 'fanya juu' (steep backslope) terraces which reduce slope length and slope angle. Construction of shallow contour furrows and ridges in the field before the beginning of the rains and maintaining the crop residue results in reduced runoff and increased soil and water conservation. Having this in mind the aim was to devise a cheap way of constructing contour furrows and ridges to supplement the terraces and mulch in soil and water conservation.

In this paper soil tillage needs related to soil and water conservation will be discussed in the total context of the existing farming system. Since tillage requirements are location, soil, climatic and crop specific it is necessary to state the conditions for which the soil tillage equipment was developed.

Locations

The semi-arid area referred to in this paper includes Lower Muranga, Lower Kirinyaga, Lower Embu, Lower Meru, Lower Machakos and Central Kitui. However, most of the research data was collected at Katumani Dryland Agricultural Research Station and the surrounding area. A limited number of experiments were conducted in heavy clay soils of the Rhine basin in Holland while the first author was studying at Wageningen.

Climate

The area has bimodal rainfall ranging between 625 and 875 mm. annually split almost equally between the long rains (March-June) and the short rains (October-January) Figure 1. The bimodal rainfall which averages 685 mm per annum shows that only in 4-ten day periods in April and November, does rainfall exceed crop water requirements. Rainfall in December and March and May is likely to meet crop water requirements, two in seven years for December and one in five years for March and May (M'Arimi, 1977).

Soils

The soils are mainly derived from basement complex rocks except in Murinduko and Kindaruma areas where the soils have developed on volcanic rocks. There are significant pockets of black cotton soils occurring in plains and broad depressions within the area. The soils derived from basement complex are friable clays, sandy clay loams and loamy sands. They tend to harden when dry but are friable when wet. They are deep and well drained in the wetter areas but tend to be shallow in the drier areas due to the presence of petroplinthite (murrum) horizons (M'Arimi, 1977). At Katumani Dryland Research Station the soils are ferral-chromic luvisols, deep, well drained dark reddish brown sandy clay and clay loam (Mbuvi and van de-Weg, 1975; Barber et al., 1979). If left bare they have a pronounced tendency to crust under rainfall impact. A compact layer develops approximately 100 mm below the surface due to clay movement and soil moisture depletion.

**FIG. 1: 20 - yr average rainfall for Katumani,
Source: Stewart (1980)**

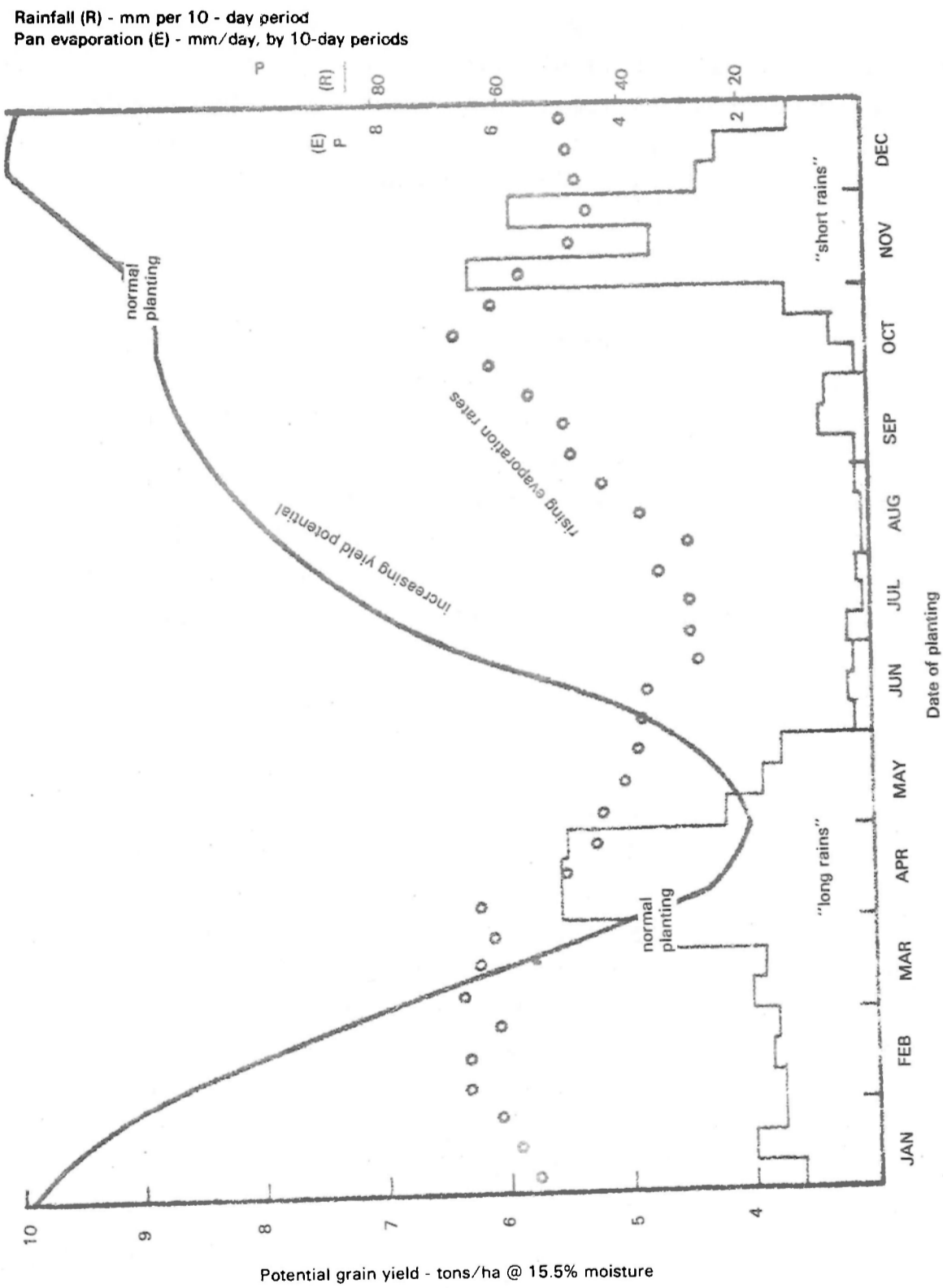

Cropping system

The crops grown in these areas are maize, beans, pigeon peas, cowpeas, bulrush millet, sorghum, sweet potatoes and cassava. Cotton and tobacco have recently been started. Allan (1971) identified six factors that affect crop yield namely late planting, late weeding, low quality seeds, low fertility, low plant population and inadequate plant protection. For the maize crop, appropriate and feasible recommendations are available for the last four factors (M'Arimi, 1977). They can be implemented easily using the currently available equipment. However without timely planting, weed control and soil and water conservation other improvements (although easier to adopt) have little pay-off.

Labour

Available family labour is about 3 adults per holding, but it is sometimes supplemented by casual labour during the peak seasons of early land preparation and weeding. However, due to high labour costs late planting and late weeding are common causes of low yields. Appropriate mechanisation could alleviate this problem.

Existing mechanisation

There are three levels of mechanization in the semi-arid areas of Kenya, namely hand tools, ox-cultivation, and tractor equipment. Hand tools are too slow and tractor mechanisation too expensive and not suitable for these small and steep sloping plots. Ox-cultivation was introduced about 60 years ago and has reached more than 70% adoption (Mutebwa, 1979) in some restricted areas. It was adopted because of its superiority in soil loosening, rate of work, and above all labour saving.

The only available implement has been the moulboard plough (Figure 2) which under the hard dry conditions has a very high draught requirement which cannot be easily supplied

by a pair of bullocks that are often not physically fit after the long drought. This has resulted in delayed planting and subsequent operations.

METHODOLOGY

Tillage Equipment

The following tillage tools were tested under different conditions to evaluate their effectiveness in timeliness of operation, draught requirement and soil and water conservation potential (figures 2, 3 and 5):

1. mouldboard plough
2. A-shares
3. Chisels
4. Desi plough

All the above tools were mounted on a sine hoe tool bar as shown in figure 4.

Measuring Equipment

A reliefmeter (figure 6) was used to measure the surface roughness and furrow cross-section, a tape measure for the depth and plot sizes, a stop watch and a drawbar dynamometer for the time and draught respectively.

Design of experiments

The plot size was 30 x 7 m of a split plot design (Fig. 7) on a large field (300 x 50 m). Main plots are planting methods. Subplots are tillage treatments. Since there was a large variation of slope and soils, each treatment was replicated at least 4 times. The following data was collected for each plot and treatment:

- a) depth of tillage
- b) rate of primary tillage
- c) micro-relief
- d) draught.

FIG. 2: Traditional mouldboard (Victory) plough used by farmers

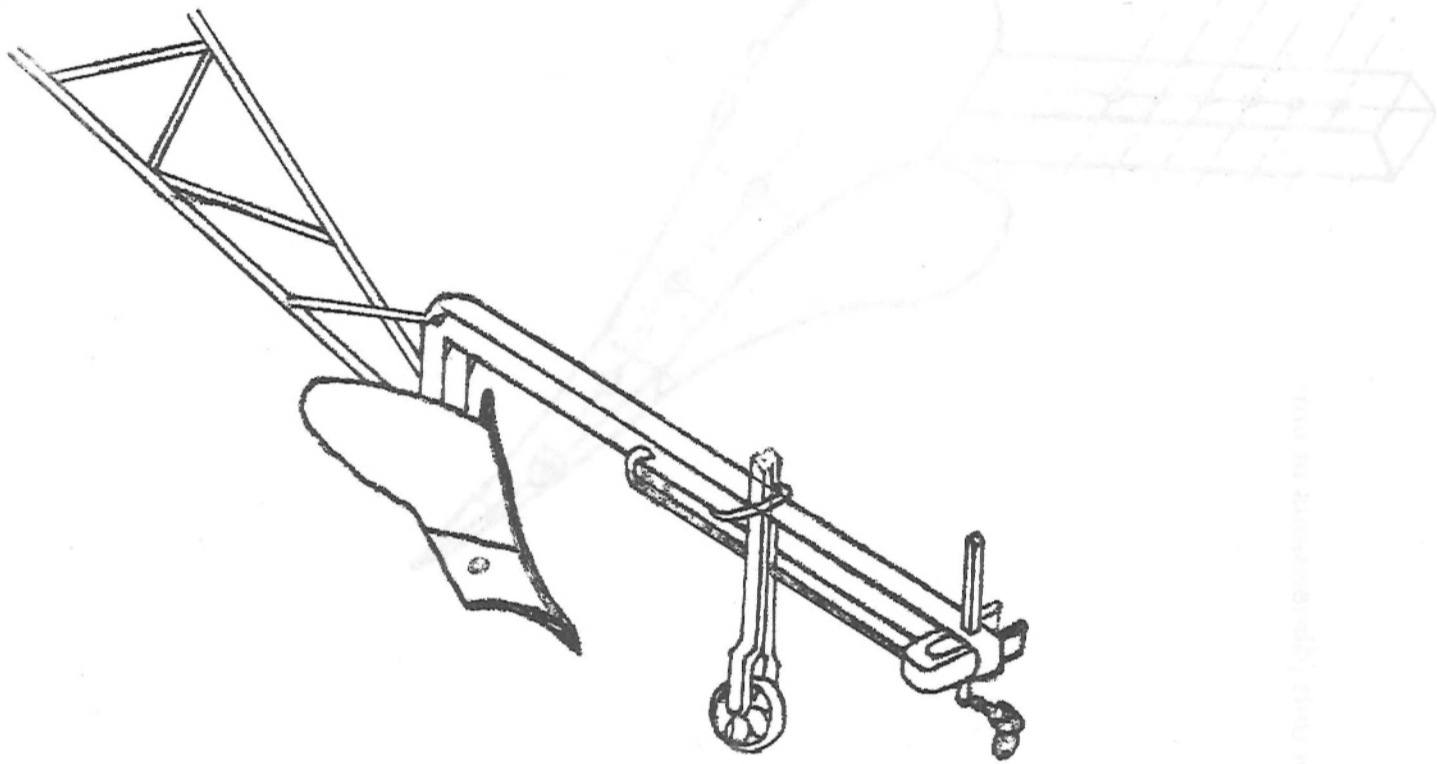
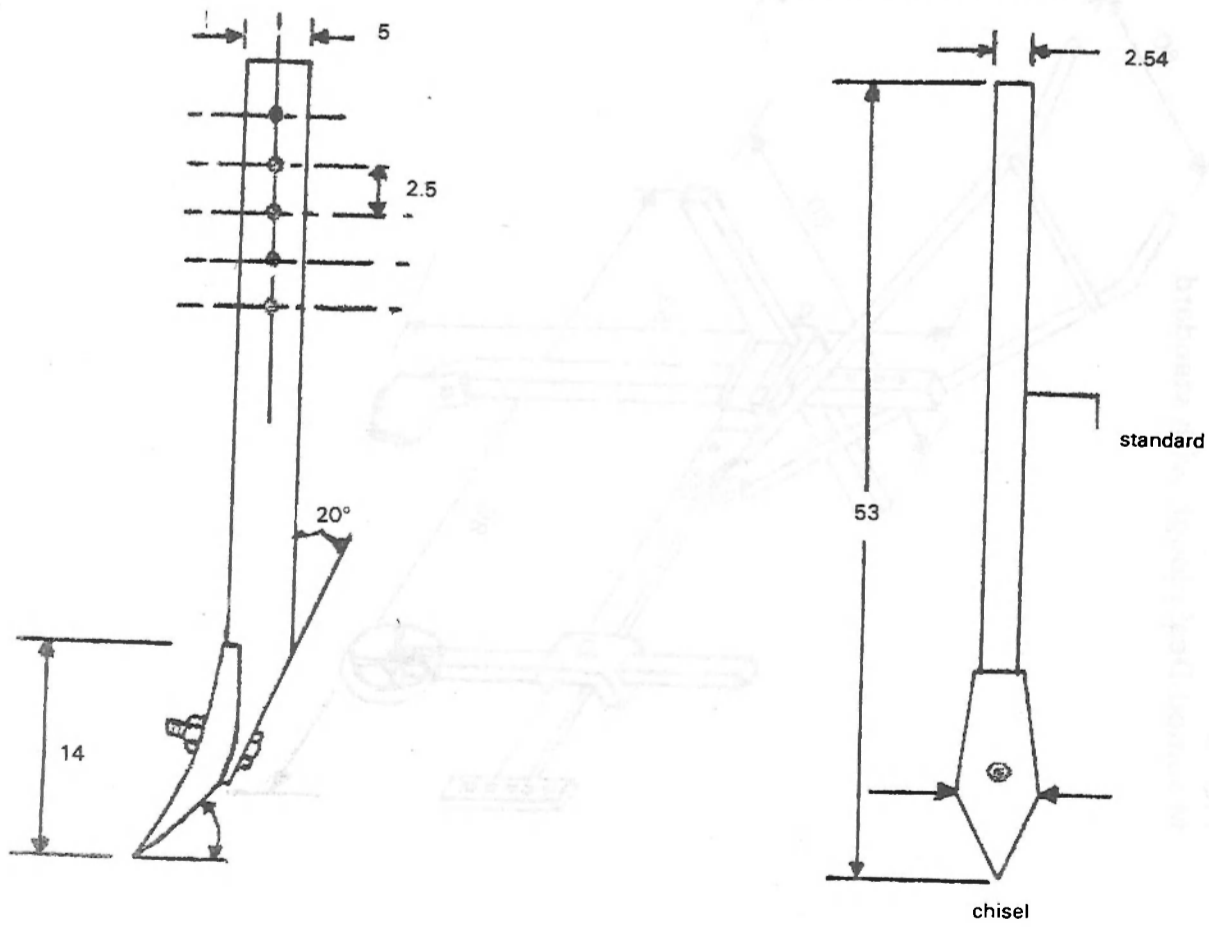

FIG. 3: Ariana chisel share mounted on the standard (dimensions in cm)



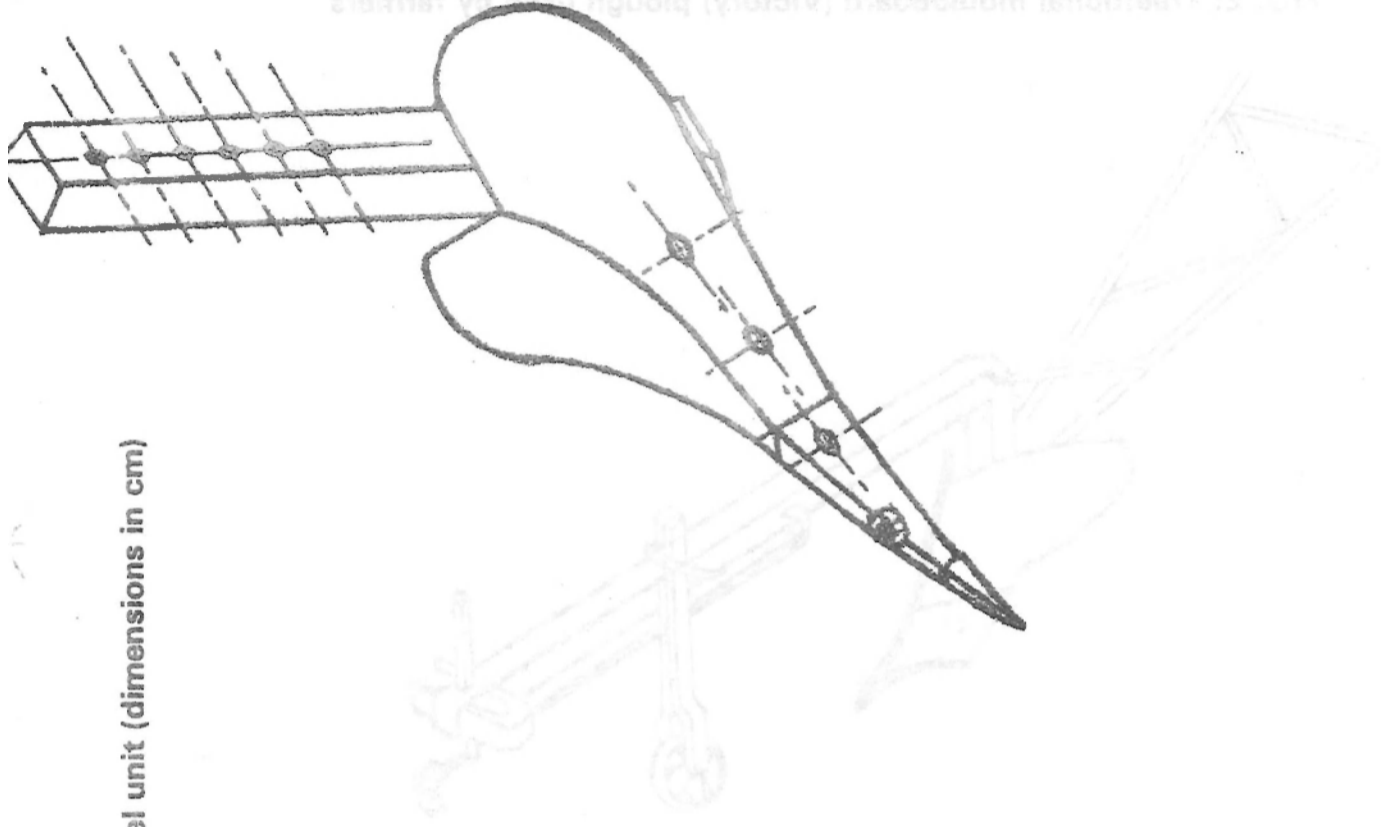

FIG. 4
Sine hoe assembly with share and standard of the Rumpstad Chisel unit (dimensions in cm)

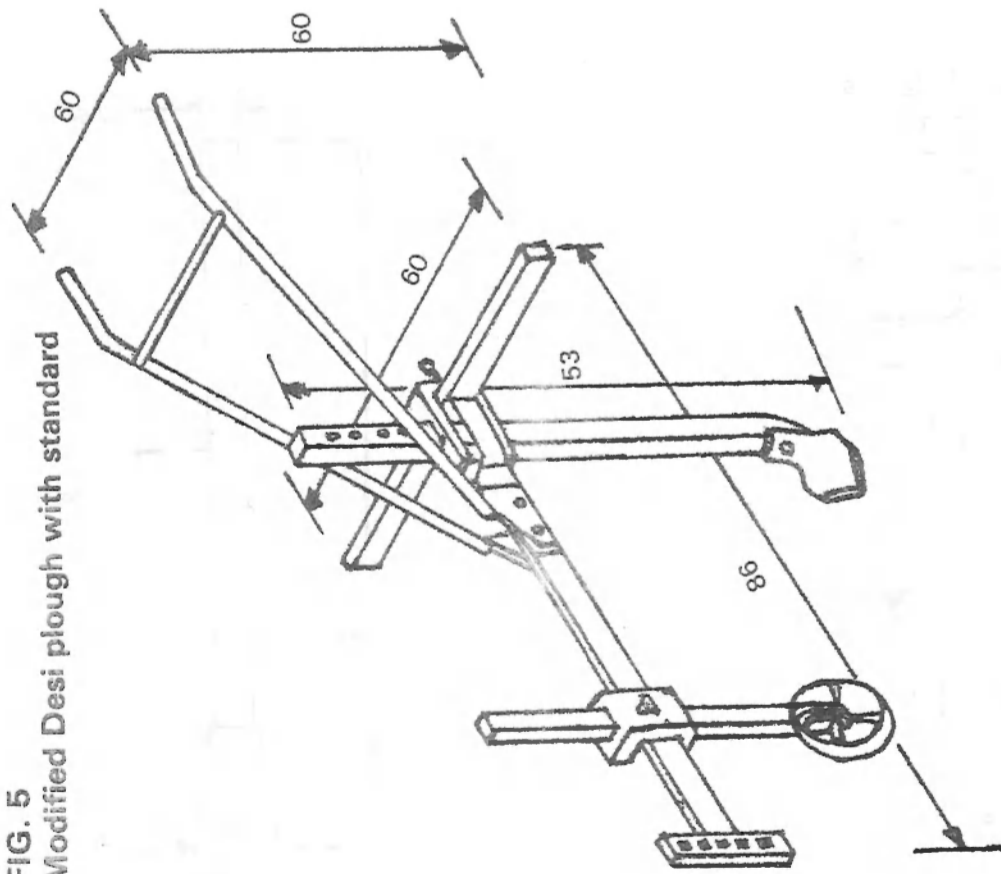

FIG. 5
Modified Desi plough with standard

FIG. 6: Drawing of the micro relief meter (dimensions in cm)

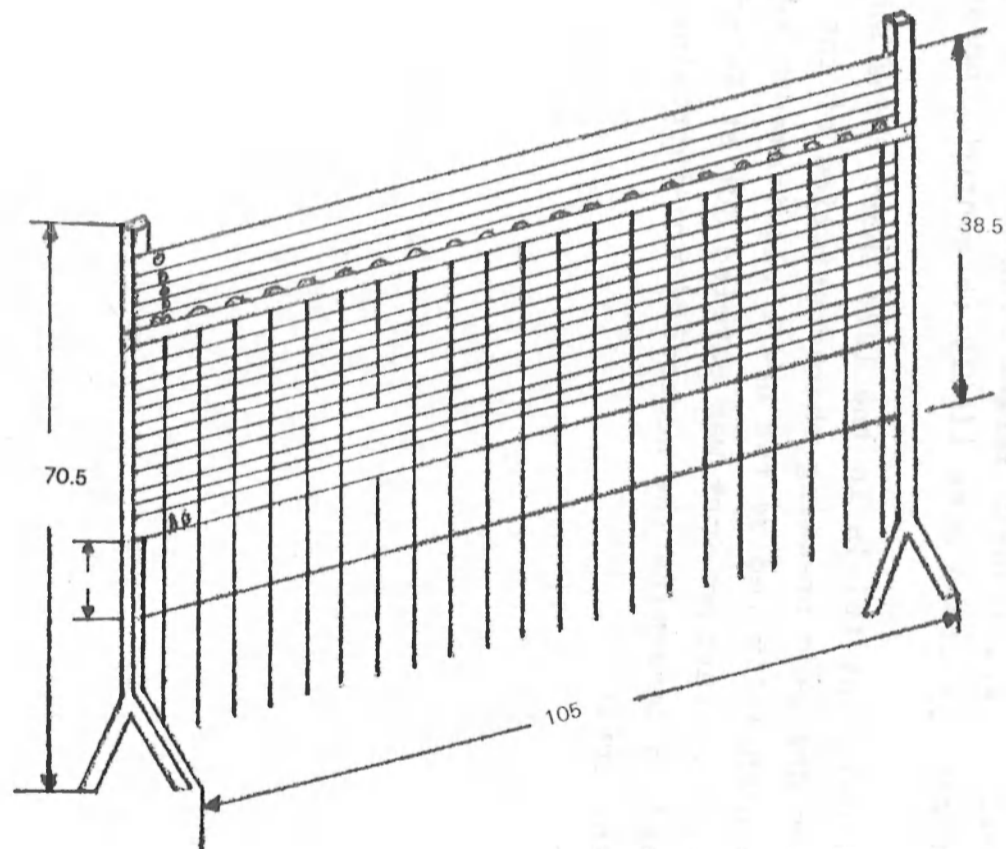
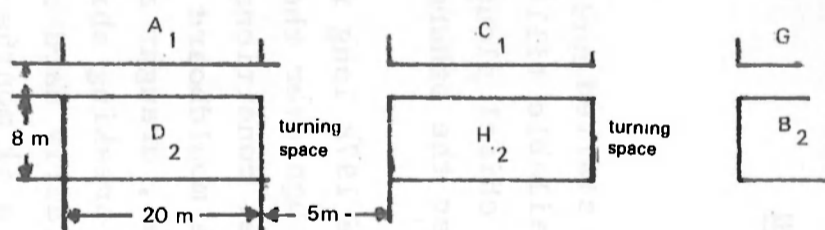
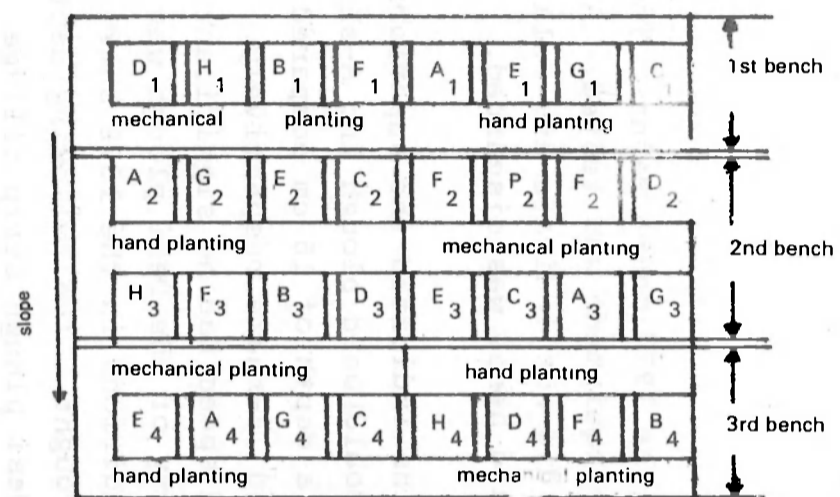

FIG. 7: Plot layout, October 1978



- Key
- A & B - mouldboard plough
 - C & D - A - share
 - E & F - Desi-plough complete
 - G & H - Desi-plough minimum millage
 - A, C, E, & G - All hand planted
 - B, D, F & H - All mechanical planted

RESULTS AND DISCUSSION

Tillage Operation

This work was started during the 1977 short rains. The performance of all available tillage equipment was tested. After a series of tests the chisel plough did not indicate any relative advantage in depth over the others and hence was discarded.

Results of the 1978 long rains indicated the superiority of a modified Desi plough over the mouldboard plough and A-share by achieving, under wet conditions, a depth of 16 cm compared to 10 cm and 9 cm for the mouldboard and A-share respectively. The cross-section areas, draught and speed had no significant difference. The land breaking ability of the Desi plough was confirmed by work on fairly hard conditions in the 1978 short rains which preceded a 5½ months drought. The following depths were achieved: Desi plough 9.2 cm; Desi plough strip tillage 11.5 cm; mouldboard plough 5.7 cm; A-share 7.7 cm. The corresponding roughness coefficients are shown in Table 1. The Desi strip tillage had a significantly larger roughness coefficient. This treatment was therefore more likely to control surface runoff.

Subsequent trials in the 1979 short rains showed that the better dry land breaking characteristics of the Desi plough would be highly limited by the draft requirements averaging 183 kg (Table 2). Further work was carried out at Katumani and in Holland to determine the necessary pre-furrowing operation to reduce the draft.

Table 1: Roughness coefficients given by $R = 100 \times \log_{10} S.D.$
(1978 short rains)

| Treatments | B l o c k s | | | | Treatment totals | Means |
|--------------------|-------------|--------|--------|--------|------------------|-------|
| | I | II | III | IV | | |
| Mouldboard | 37.41 | 32.79 | 27.22 | 38.32 | 135.74 | 33.93 |
| A-share | 37.10 | 27.42 | 44.21 | 32.54 | 141.27 | 35.31 |
| Desi-plough | 40.01 | 46.89 | 32.80 | 40.01 | 159.71 | 39.92 |
| Desi strip tillage | 60.42 | 57.38 | 61.95 | 43.55 | 223.30 | 55.82 |
| Block total | 174.94 | 164.48 | 166.18 | 154.42 | 660.02 | |

A N O V A

| | D of F | SS | Variance | F |
|----------------------|--------|---------|----------|---------|
| Total | 15 | 1752.59 | | |
| Blocks | 3 | 54.10 | 18.03 | 0.50 |
| Treatment | 3 | 1376.53 | 458.84 | 12.82** |
| Error | 9 | 321.96 | 35.77 | |
| LSD (P = 0.01) | = | 9.6 | | |
| Studentised range, D | = | 18.7 | | |

Table 2: Drawbar draught force, field capacity and depth of cultivation for desi-plough and farmers mould-board plough during October-December 1979

| | draft (kg) | speed (m/s) | depth (cm) | rate of work (hours/ha) |
|---|---------------|----------------|---------------|----------------------------|
| a) <u>Desi-plough under dry conditions</u> | 175 | 0.38 | 8.7 | 9 |
| | 207 | 0.40 | 8.6 | 9 |
| | 180 | 0.36 | 9.2 | 10 |
| | 187 | 0.44 | 7.3 | 8 |
| | 178 | 0.37 | 9.0 | 10 |
| | 203 | 0.40 | 8.6 | 9 |
| | 187 | 0.36 | 9.0 | 8 |
| | 173 | 0.50 | 11.6* | 5 |
| | 162 | 0.50 | 11.7* | 5 |
| | 167 | 0.83 | 12.6* | 4 |
| | 167 | 0.85 | 12.8* | 4 |
| Mean | 183 | 0.41 | 9.3 | 8.1 |
| S.D. | 14.3 | 0.06 | 1.43 | 1.9 |
| b) <u>Desi-plough under wet conditions</u> | 75 | 0.50 | 8.7 | 8 |
| | 78 | 0.38 | 9.6 | 10 |
| | 108 | 0.42 | 8.8 | 9 |
| | 88 | 0.50 | 9.2 | 8 |
| | 88 | 0.44 | 8.6 | 8 |
| Mean | 87 | 0.45 | 9.0 | 8.6 |
| c) <u>Mould-board plough under wet conditions</u> | 91 | 0.39 | 8.1 | 9 |
| | 76 | 0.45 | 8.0 | 10 |
| | 76 | 0.39 | 7.9 | 9 |
| | 94 | 0.39 | 8.0 | 10 |
| | 96 | 0.42 | 9.0 | 8 |
| | 77 | 0.46 | 7.8 | 9 |
| | 93 | 0.59 | 10.0 | 8 |
| | 88 | 0.36 | 9.5 | 8 |
| | 74 | 0.32 | 7.7 | 8 |
| | 80 | 0.36 | 7.8 | 8 |
| | 103 | 0.34 | 8.2 | 10 |
| Mean | 86 | 0.41 | 8.4 | 9.4 |
| S.D. | 9.9 | 0.09 | 0.78 | 1.7 |

*Variation in soil conditions and relative tiredness of oxen during the ploughing period cause large differences in depth of cultivation and speed.

Using 2 or 3 chisel points on the sine hoe tool bar, was found to be ineffective in land breaking due to high draft requirements. Use of one chisel point was therefore studied both in Holland and later in Kenya. Figure 4 shows the single unit developed for pre-furrowing chiselling.

The result of the work done under controlled conditions are reported in Table 3. The corresponding furrows are shown in figure 8 (a) and (b).

Table 3: Comparison of performance characteristics between a Desi plough on uncompacted soil and Desi plough after chisel on hard compacted soil in Holland

| | Desi plough | Desi plough after chisel |
|--|-------------|--------------------------|
| Horizontal draught force (kg) | | |
| Range | 61-219 | 23-102 |
| Mean | 158 | 57 |
| Vertical force (kg) | | |
| Range | 18-80 | 3-24 |
| Mean | 51 | 14 |
| Furrow cross-sectional area (cm ²) | | |
| Range | 86-240 | 100-206 |
| Mean | 171 | 145 |
| Depth (cm) | | |
| Range | 9.16 | 9.5-14 |
| Mean | 10 | 12 |
| Specific soil resistance (kg/cm ²) | 0.92 | 0.40 |

Note: The above operations were carried out using a tractor at a speed of 1.5 km/hr.

FIG. 8 (a): Furrows produced by the Desi Plough after Rumpstad chise on compacted soil- average depth 12 cm.

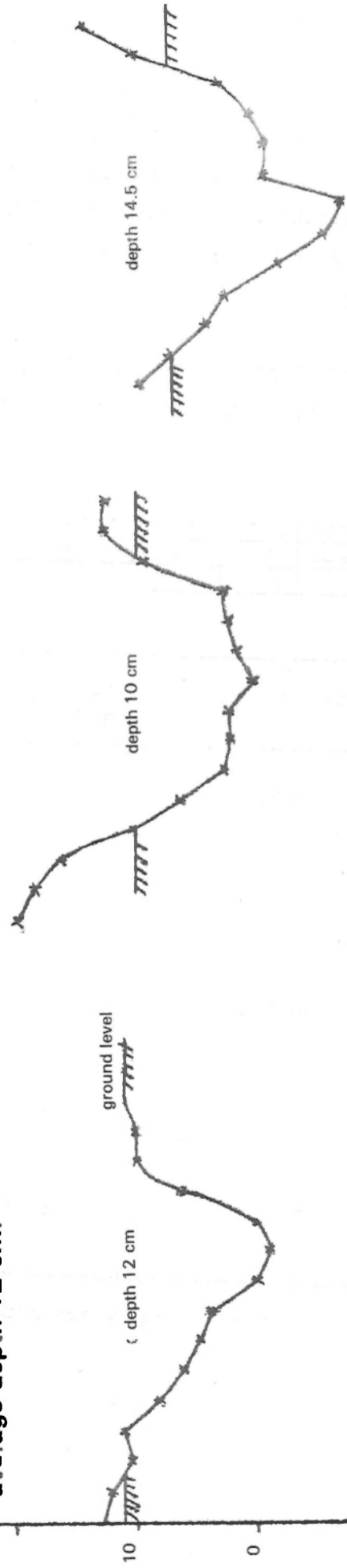

FIG. 8 (b): Furrows produced by the Desi Plough after Ariana chisel on compacted soil- average depth 12 cm.



The Desi plough after chiselling had a lower specific soil resistance thus reducing the draught requirement to produce an equal size furrow. The single chisel land breaking was further tested in Kenya in 1981 long rains and average depths of 11.5 cm and 14.0 cm were achieved on the stubble and fallow respectively. Subsequent Desi ploughing reached a depth of 15.2 cm. The average Desi plough was 104 kgf and 108 kgf for the stubble and fallow respectively. The value and feasibility of chiselling before furrowing using two bullocks was established.

Strip chiselling and backtracking with a Desi plough gave very little weed control between the rows. However due to the urgency of planting early with the first rains, the farmer should plant in the furrow, leave the inter-row spacing covered with trash and few or no weeds. After the farmer completes his planting he can start on inter-row cultivation. The ground, being relatively soft, could be tilled using a set of A shares followed by hand weeding. Our trials indicated very effective weed control and good establishment of the crop when these tillage implements and methods were used.

Evaluation of Furrow Effectiveness in Soil and Water Conservation

In this section the furrows being produced by the Desi plough will be evaluated in terms of their effectiveness in controlling surface runoff created by excess water produced from rainfall intensities with return periods of 5 and 10 years.

Two methods are applied in predicting the likely runoff. In the first, the amount received in certain durations less the amount that would infiltrate, estimated by a basic infiltration rate, gave the resulting surface runoff. In the second, the runoff is estimated from observed rainfall simulator data.

Table 4 shows the rainfall amounts for various durations at Machakos Dam near Katumani which were used for the first method of runoff estimation.

Table 5 shows the amount of runoff calculated. Using an estimated basic infiltration rate of 20 mm per hour (Kijne, 1980; Barber, 1979), the runoff is obtained by subtracting infiltration from rainfall.

For the furrow spacing of 90 cm the expected volume of runoff per metre length of furrow per mm of runoff is given by:

$$\begin{aligned} \frac{1}{1000} \text{ m} \times 0.9 \text{ m}^2 &= 0.0009 \text{ m}^3 \\ &= 0.9 \text{ litres/mm of runoff} \end{aligned}$$

This factor is used to convert runoff in mm into runoff in litres per metre given in column 5 of Table 5.

In the second method the runoff is based on rainfall simulator data obtained at Katumani in November 1977 (Barber et al., 1979), on cultivated land with a slope of 13%.

Table 6 shows the rainfall intensity, duration and frequency for Machakos Dam. Similar rainfall events were simulated and runoff was measured for various durations. Figures 9a and 9b indicate the runoff rates versus time for different rainfall intensities. The area under the curve represents the amount of runoff for any particular intensity and duration. Figure 9a represents the expected runoff from a dry soil, i.e. soil at permanent wilting point, before the rains start. Figure 9b represents the expected runoff from a wet soil at field capacity when the rain starts. 75 mm/hr rainfall intensity is an interpolation between 100 mm/hr and 50 mm/hr intensity curves.

Table 7 gives the observed runoff in mm and litres per metre of furrow on dry and wet soil for various rainfall intensities, durations and return periods. Out of ten conditions examined only 3 are above 23 mm or 21 litres per m furrow length, the highest being about 39 mm.

Comparing the two methods it appears that the first method tends to overestimate runoff. For instance, 26 mm falling in 15 minutes produces a runoff of 21 mm according to the first method while the observed runoff on wet soil from 25 mm

Table 4. Rainfall in mm. for Machakos Dam for various durations in 5 and 10 year return periods

| Return period | 15 min. | 30 min. | 60 min. | 180 min. |
|---------------|---------|---------|---------|----------|
| 10 years | 26 | 36 | 55 | 84 |
| 5 years | 23 | 33 | 46 | 71 |

Source: Taylor and Lawes (1971). Rainfall intensity-duration-frequency data for stations in East Africa, E.A. Met. Dept. Tech. Memoir No. 17.

Table 5. Estimated runoff for various rainfall durations in 10 and 5 year return periods

| 10-year return period | | | | |
|-------------------------|----------------------|-------------------|-------------|---|
| Rainfall duration (min) | rainfall amount (mm) | infiltration (mm) | runoff (mm) | runoff in litres/metre of furrow length |
| 15 | 26 | 5 | 21 | 18.9 |
| 30 | 39 | 10 | 29 | 26.1 |
| 60 | 55 | 20 | 35 | 31.5 |
| 5-year return period | | | | |
| 15 | 23 | 5 | 18 | 16.2 |
| 30 | 33 | 10 | 23 | 20.7 |
| 60 | 46 | 20 | 26 | 23.4 |

Note: The infiltration rate used is 20 mm/hr which is what would occur when the rain falls when the soil is saturated and would contribute to the highest runoff (Columns 4 and 5).

Table 6: Rainfall intensity, duration and frequency for Machakos Dam

10 years return period

| Rainfall intensity | <u>Duration</u> |
|--------------------|-----------------|
| 100 mm/hr | 16.5 min |
| 75 " | 32.4 " |
| 50 " | 70.2 " |
| 25 " | 216 |

5 years return period

| | |
|-----------|----------|
| 100 mm/hr | 10.5 min |
| 75 " | 22.8 " |
| 50 " | 51.6 " |
| 25 " | 165 " |

Source: Ministry of Water Development. Rainfall intensity-Duration-frequency relationship for Machakos Dam.

falling in an equal period of time produces 13 mm runoff according to the second method. Also 39 mm falling in 30 minutes produces a runoff of 29 mm according to the first method but 40.5 mm falling in 32.4 min produces 23 mm runoff. For a duration of 60 min the first method estimates that 55 mm rainfall would cause runoff of 35 mm. In the second method 58.5 mm falling in 70.2 min produced a runoff of 43 mm. Interpolated to 55 mm falling in 60 min the runoff would be 35 mm. Here the two methods give equal estimates. It would therefore appear that actual infiltration depends on rainfall intensity and duration as well as soil conditions and no easy formula is likely to give consistent results. The second method based on actual observation is therefore more reliable but it is expensive to carry out for a large area.

In order to determine the effectiveness of the furrows in stopping and holding the runoff until it infiltrates into the soil, 15 furrow cross-sections were sampled randomly and the area

FIG. 9 (a): Runoff time graph for varying rainfall intensity - (Katumani) dry soil.

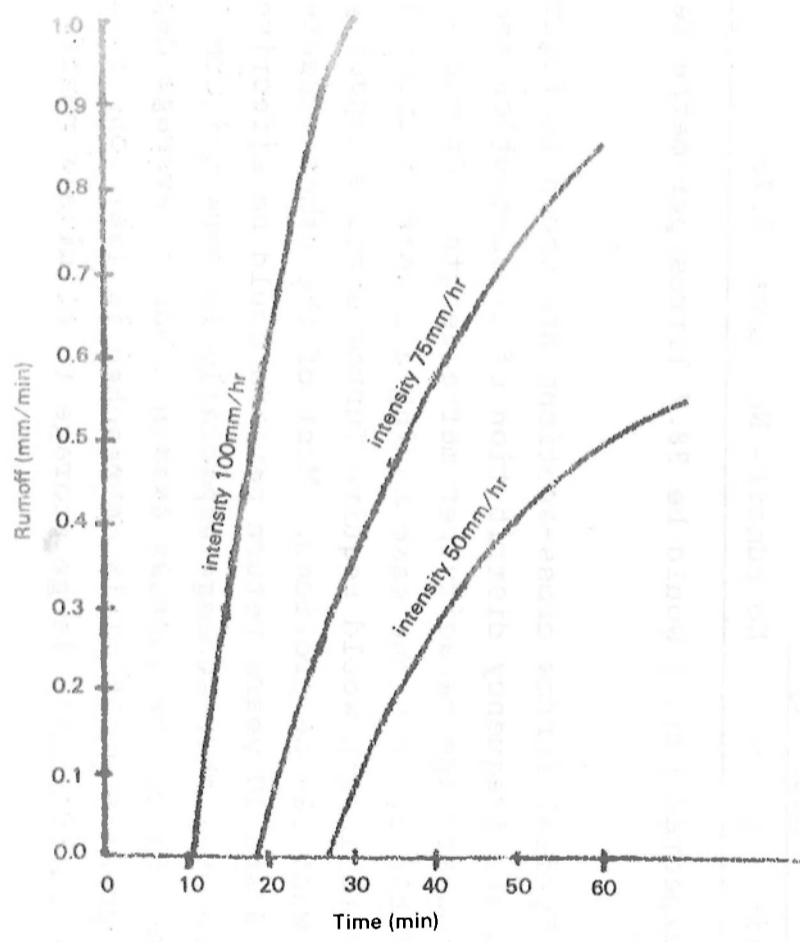

FIG. 9 (b): Runoff time graph for varying rainfall intensity -
Katurmani dry soil

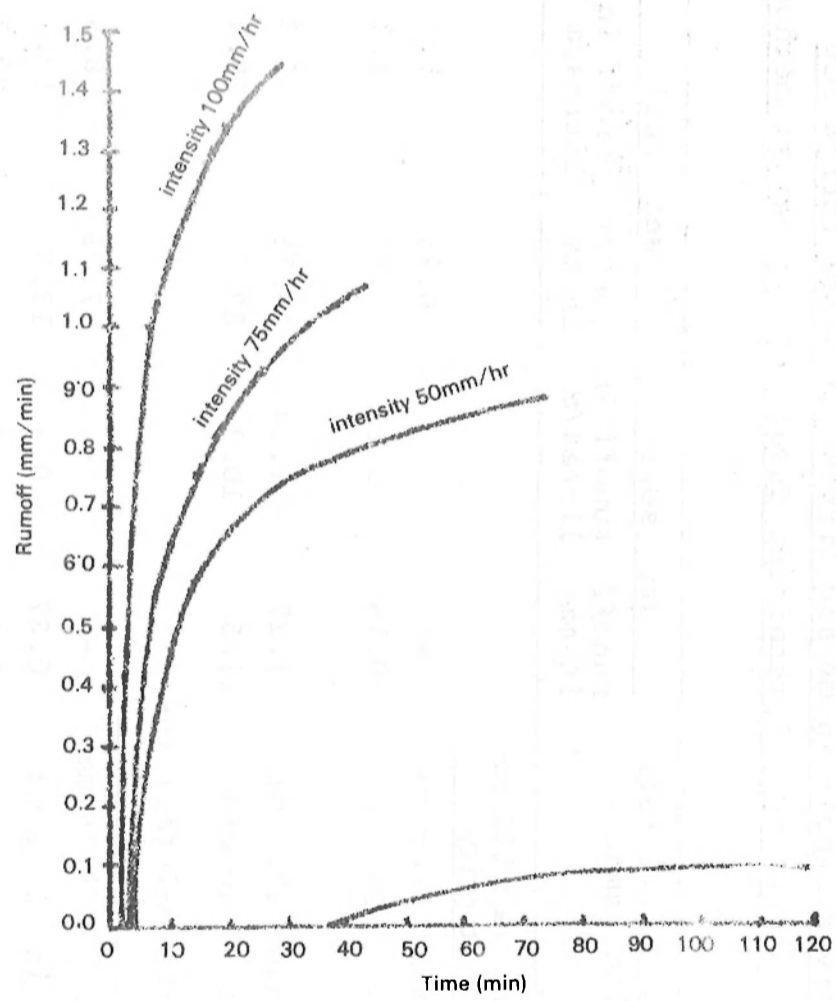

Table 7: Observed runoff in mm and litres per metre furrow for various rainfall intensities durations and return methods

| Return period | Rainfall duration | Rainfall amount | dry soil | | wet soil | |
|-------------------------------------|-------------------|-----------------|--------------|--------------------|--------------|---------------------------|
| | | | runoff in mm | runoff in litres/m | runoff in mm | runoff in litres/m length |
| <u>100 mm/hr rainfall intensity</u> | | | | | | |
| 5 yrs | 10.5 min | 17.5 mm | - | - | 6.75 | 6.0 |
| | 15 min | 25 min | 0.75 | 0.67 | 12.75 | 11.5 |
| 10 yrs | 16.5 min | 27.5 mm | 1.27 | 1.14 | 14.75 | 13.3 |
| | 30 min | 50 min | 11.5 | 10.3 | 33.3 | 29.8 |
| <u>75 mm/hr rainfall intensity</u> | | | | | | |
| 5 yrs | 15 min | 18.75 mm | - | - | 7.25 | 6.5 |
| | 22.8 min | 28.5 mm | 0.37 | 0.3 | 13.5 | 12.1 |
| 10 yrs | 32.4 min | 40.5 mm | 2.6 | 2.34 | 23.0 | 20.7 |
| <u>50 mm/hr rainfall intensity</u> | | | | | | |
| 5 yrs | 51.6 min | 43 mm | 5.5 | 4.9 | 28.56 | 25.7 |
| 10 yrs | 70.2 min | 58.5 mm | 15.0 | 13.5 | 43.0 | 38.7 |
| <u>25 mm/hr rainfall intensity</u> | | | | | | |
| | 120 min | 50 mm | No runoff | No runoff | 5.75 | 5.1 |

The highest expected runoff would be 38.7 litres per metre length of the furrow.

determined. Typical furrow cross-sections are shown in Figure 10. Table 8 shows the frequency distribution of cross-section and the range of furrow storage capacity per metre length. Of the situations examined in Table 8, only one case having a runoff of about 39 litres per metre length would require furrow storage capacity greater than what can be provided. Most of the other expected runoffs with 5 and 10 years return periods could be effectively handled by the available storage especially if more uniform furrows could be made. Since the furrows examined had an average depth of 9.3 cm, a greater depth of 15 cm (reached in 1981 long rains) would provide sufficiently large storage to eliminate runoff altogether.

It is however, important to note that the furrow must not be broken, and if it does get broken during weeding another one must be made between the crop rows. Otherwise severe erosion is likely as was the case in the 1981 long rains where the furrows had been broken during weeding. Tied furrows or ridges may be used to eliminate any possibility of a broken furrow initiating gully erosion. This would help to overcome the problem of overtopping which can occur if furrows are not on the contour and water concentrates at low spots.

Table 8: The frequency distribution of furrow cross-section area and furrow storage capacity

| Frequency | Frequency % | Cumulative Frequency % | Furrow cross-sectional area values in cm ² | Furrow storage range in l/m length of furrow |
|-----------|-------------|------------------------|---|--|
| 1 | 1.6 | | 375 | >35 |
| 3 | 5.0 | 6.6 | 340, 325, 325 | 32.5-35 |
| 2 | 3.3 | 9.9 | 310, 300 | 30-32.5 |
| 4 | 6.5 | 10.4 | 232.5, 280, 275, 275 | 27.5-30 |
| 10 | 16.4 | 32.8 | 265, 265, 257.5, 255, 255 | |
| | | | 252.5, 250, 250, 250, | 25-27.5 |
| 2 | 3.3 | 36.1 | 242.5, 240 | 22.5-25 |
| 4 | 6.5 | 42.6 | 210, 207.5, 202.5, 200 | 20-22.5 |
| 7 | 11.0 | 53.6 | 190, 185, 182.5, 182.5, 177.5, 177.5, 175 | 17.5-20 |
| 9 | 14.7 | 68.3 | 167.5, 176.5, 155, 152.5, 150, 150, 150, 150, 150 | 15-17.5 |
| 6 | 10.0 | 78.3 | 140, 130, 125, 125, 125, 125 | 12.5-15 |
| 8 | 13.0 | 91.3 | 120, 105, 105, 102.5, 100, 100, 100, 100 | 10-12.5 |
| 5 | 8.2 | 99.5 | 92.5, 82.5, 75, 75, 75 | 7.5-10 |

The mean furrow storage capacity is 19 litres/metre length of furrow.

In addition to controlling the runoff the 15 cm deep furrows would enable planting at a depth of 10-12 cm without covering the seed too much. This gives the plant a greater opportunity to develop deep roots before the rainfall season tails off. Early

FIG. 10: Typical furrow cross sections made by Desi plough. Dimensions are in cm.

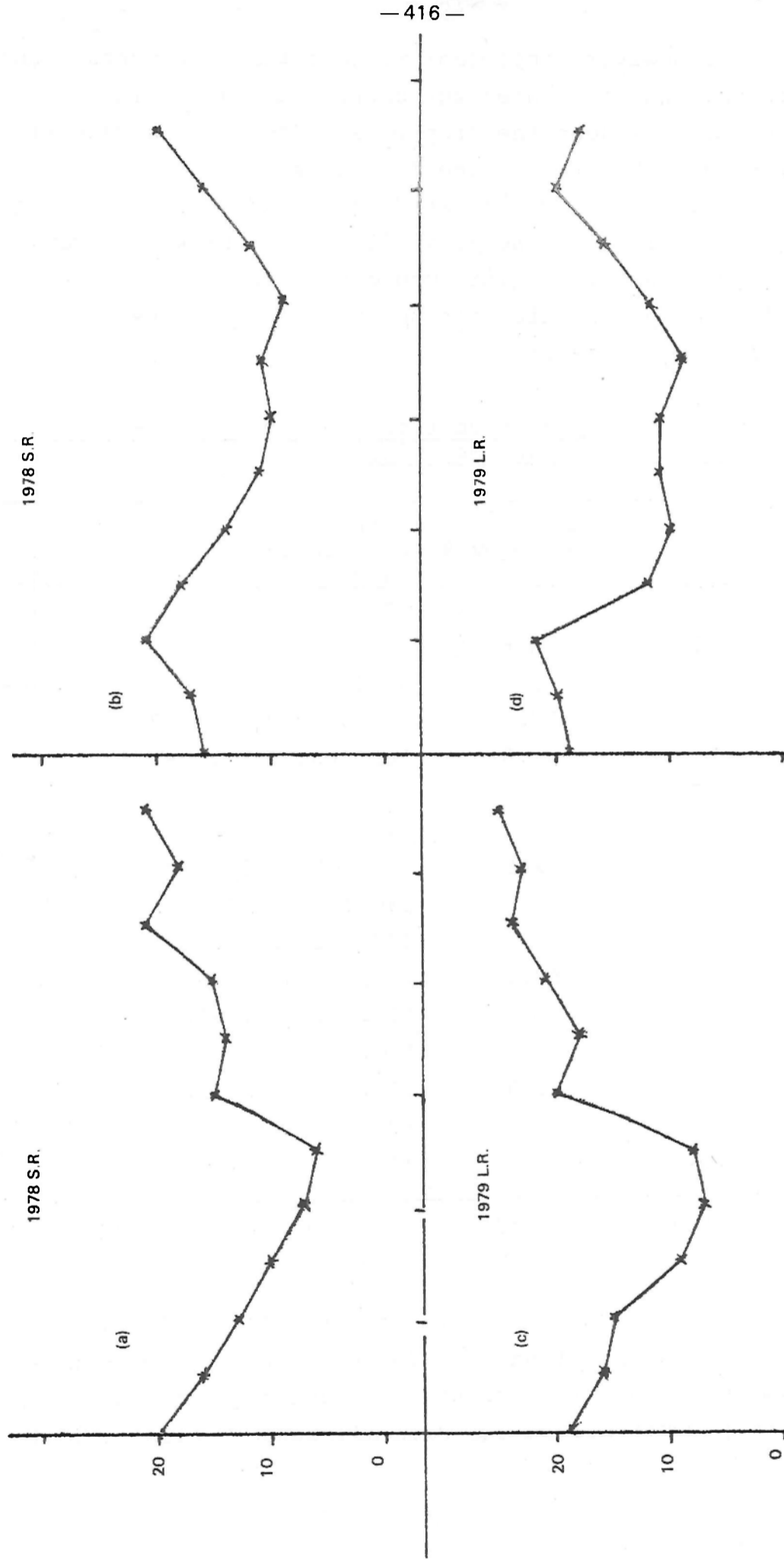

wetting of the subsurface compacted layer is an added advantage. If a temporary drought develops during the planting stage furrows maintain sufficient soil moisture to initiate germination. In one observation a good crop germinated purely from the conserved moisture in the furrow.

The main fear in planting in the furrow is water logging. This depends on the soil type. At Katumani an infiltration rate of 20 mm per hour on the wet soil ensure that the largest excess water amounting to 43 mm would be cleared in about 2 hours. Where infiltration rate is too low furrows need to be graded (ICRISAT, 1979) to get rid of excess water.

CONCLUSION

The implements developed have received limited farmer acceptance trials with encouraging results. The farmer can benefit from these implements and this tillage method in the following ways.

There is low labour requirement and hence his family labour would be released to fetch water, firewood, or take employment elsewhere.

There is a low draught requirement that can easily be applied by his two bullocks even under very dry conditions.

The operations are fast to ensure timeliness of tillage and weed control.

The resulting seedbed is good and as it can be prepared in the dry season. Improved pest and weed control can also be achieved.

With a better control of runoff in the plot we could advocate a wider terrace spacing. This requires further trials. This tillage method and the implements should be used in conjunction with mulch tillage and other conservation practices.

It is the purpose of this paper to illustrate the value of land operations designed to improve the use of soil micro-relief for greater soil and water conservation. However, much more needs to be done along these lines of research and field trials before the soil reservoir of the many soil types of our semi-arid areas can be used to the best advantage.

REFERENCES

- Allan, A.V. (1971) Influence of Agronomic factors on maize yield in Western Kenya. PhD. thesis submitted to the University of East Africa.
- Anderson, D.T., Rajput, D.S. and Yadav, G.C. (1980). Mechanising Dryland farms of semi-arid India. Proceeding of AAASA Workshop on Appropriate Mechanisation of Small Farms. Nairobi, Kenya.
- Barber, R.G., Moore, T.R., and Thomas, D.B. (1979) 'The Erodibility of two soils from Kenya' Journal of soil Science, 30:579-591 .
- International Crops Research Institute for the Semi-Arid Tropics 1979. Annual Report. Hyderabad. India.
- Kijne, J.W. (1980). Design procedures for furrow irrigation on small holdings. Department of Agricultural Engineering, University of Nairobi.
- M'Arimi, A.M. (1977). The effect of tillage methods and cropping sequence on rainfall conservation in semi-arid areas of Eastern Kenya. Unpublished MSc. Thesis, University of Nairobi.
- Mbuvi, J.P. & R.F. Van de weg (1975). Some preliminary notes on the soils of Katumani, Kampi ya Mawe, Embu and Murinduko Agricultural Research stations Kenya. Kenya Soil Survey.
- Mutebwa, A.B. (1979). Determination of mechanisation levels with respect to land size and labour in Semi-Arid Areas of Kenya; Findings from Lower Kirinyagah. Unpublished MSc. Thesis. Department of Agricultural Economics. University of Nairobi.
- Russell, E.W. 1961. Soil conditions and plant growth. Ninth Ed. Longmans.

QUESTIONS AND COMMENTS

Compiled

By

Mr. R.G. Barber

Participants who contributed to the discussions were asked to write down their comment and questions. These were passed to the speakers so that they could give a considered reply in writing. The following report was assembled from the material which was collected. It represents only part of the discussions which took place but it is included as an indication of the kind of questions under consideration.

Paper 1 by Dr. Rowntree

Dr. De Meester commented that the vegetation effect of rainfall may become less important, in relation to its ability to counter-act rainfall erosivity, where there is large scale tractor ploughing and in overgrazed areas. Hence the soil erodibility factor will become more important. Dr. Rowntree agreed but stated that crops may grow better with more moisture and may protect the land if sown at the right moment.

Paper 2 by Mr. Barber

Dr. Mbuvi commented that in most parts of Kenya the main contributing factor to earth flows is the layer of unweathered tuff which occurs beneath the soil profile which can impede drainage and become saturated during very heavy rain. This layer then becomes the shear plane. Do the same factors cause the landslides which you have referred to in Mathioya? Mr. Barber replied, Yes they do.

Paper 3 by Dr. Lewis

Mr. Zobisch asked if the type of sediment traps used at the 28 monitoring plots in Kiambu could be described. Dr. Lewis replied they were about 0.5 meters long 0.1 meter in diameter and made out of PVC. They have an opening that permits soil to enter the trap and a short metal sheet protects

the opening from rain. An outlet on the lower part of the trap allowed excess water to flow out whilst soil was left behind. Asked how the natural erosion rates were estimated. Dr. Lewis explained that monthly rainfall data were available for Kiambu from which the expected duration and intensity values were derived. Historical records indicated the type of natural vegetation prior to clearing, and slope data was obtained from 1:50,000 topographic maps. Soil erodibility factors were determined from the physical properties of the soils. As these rates were assumed to be natural erosion rates, no human influence is considered. A modification of the USLE (SOIL CRAT) was then used to minimise over-estimation of the soil erosion rates.

Paper 4 by Mr. Ulsaker

Dr. De Meester commented that the Universal Soil Equation plays an important role in your studies. Can you confirm that the USLE is far from universal but that we still use it as nothing better exists? Mr. Ulsaker agreed. Mr. Barber said that runoff plots should ideally be installed long enough for the soil to be subjected to as wide a range of rainfall conditions as possible. How long do you think runoff plots need to be installed before a reliable estimate of the K factor can be obtained? Mr. Ulsaker replied that the K factor is developed from measurements collected from a unit plot. By definition it takes two years to develop a unit plot before measurements can begin. The period of time that measurements should be taken is not so clearly established. It is required that they be taken for a representative range of storm sizes and antecedent soil conditions. Some researchers feel one year of measurements is sufficient if that year's rainfall is above average for the area. Others have taken measurements for 10 years or more to arrive at a K value for a given soil. We hope to have a better idea of the time required after collecting one year of measurements. Dr. Mbuvi asked if the K factors were to be determined for vegetated lands since organic matter would help in reducing the 'capping' effect in Luvisols and would help to increase infiltration rates? Mr. Ulsaker replied that the K factor itself must be evaluated independently of the effects of vegetative cover, the C factor, as well as the other

factors. i.e. R, the rainfall effect; L, the slope length; S, the slope gradient; and P, the conservation practice. Generally, soil texture is the greatest indicator of a soil's erodibility and organic matter content ranks next. Therefore it is true that increasing the organic matter content tends to reduce a soil's erodibility. The problem lies in developing effective, economically feasible methods of doing this.

Paper 8 by Ms Reid

Mr. Barber commented that the sheet wash erosion rates on grazing lands of 0.5 - 1.5 mm/yr appeared to be low compared to Moore's values of 5 - 15 mm/yr. Could any explanations be offered? Ms Reid replied that the rates are not directly comparable because the diagrams showed average sediment production rates per unit area comprising various land uses, and types of topography.

Paper 9 by Dr. Norton - Griffiths

Mr. Muchena asked how soil types were quantified and whether soil descriptions were carried out in the field. In reply Dr. Norton - Griffiths said that use was made of existing soil information. If none exists field descriptions have to be made.

Paper 12 by Mr. Njoroge

Mr. Mureithi asked what the Ministry of Agriculture was doing to make sure that the requirements of the Agricultural Act concerning soil conservation are adhered to when cultivating slopes. In reply Mr. Njoroge said that the Ministry of Agriculture, through the extension service, applies the Agricultural Act and sometimes the Chiefs' Act to ensure that the cultivation of steep slopes which causes soil erosion is stopped. Moreover the extension service emphasises farmers' education in its soil conservation activities.

Paper 15 by Mr. Zobisch

Mr. Mutiso asked to what extent the Mwethya spirit is active among farmers of the highland zones of Machakos as the speaker

had found the coffee farmers of Northern Division to be individualistic. In reply Mr. Zobisch said experience had shown the self-help spirit (Mwethya spirit) to be less developed in cashcrop areas where they are less dependent on each other financially than in the subsistence farming areas. Mr. Mutiso said he was glad to hear that Technical and Junior Assistants, if well trained, could train farmers in soil conservation practices. He asked if there were efforts to decentralise the training centres e.g. on a divisional basis, since many farmers complain of the long distances they have to travel to Machakos Mr. Zobisch explained that the aim was to conduct courses at the village level with sub-locational TA's or JAA's to be in charge of the courses. They would travel to the farmers rather than the farmers travelling to the TA or JAA.

Paper 17 by Messrs Adamson, Melville and Kariuki

Mr. Njoroge asked what the Magarini project was doing to prevent destruction of trees when preparing the farmers' 4 ha plots, and whether the indigenous trees in particular were being protected. Mr. Kariuki explained that many of the large trees are left standing and efforts are being made to identify and protect the indigenous trees of the area. This is being carried out by a District forester from MENR attached to the project.

Paper 19 by Mr. Thomas

Mr. C.M. Adamson commented that artificial waterways which are made by excavation can be difficult to revegetate before they are expected to carry runoff. Where possible they should be made by constructing a bank along each side without disturbing vegetation in between. Mr. Thomas agreed that it is always better to retain vegetation but if, for some reason, excavation is necessary, it should be done after the period of peak rainfall when there is still enough moisture to establish grass and before the next rainy season. A fast growing grass should be used, and if necessary the

centre should be lined with stones. Mr. Adamson commented that roads alter the runoff pattern and road authorities should accept responsibility for controlling discharge before passing it to previously unaffected areas. Mr. Thomas agreed and stated that the road authorities should accept much more responsibility but who is responsible for drainage from certain minor roads is not always clear. Roads inevitably lead to higher peak runoff but there are opportunities for catching and using this runoff (e.g. as explained in the paper by Messrs J and G. Nightingale and as practised in Israel) which warrant further investigation. Mr. Sharman asked what can be done if a waterway needs lining but stone is not available as for example in some parts of the Elgon foothills. Mr. Thomas replied that this subject also needs investigation. The use of wooden drop structures made with treated poles could be one alternative. Where land values are high the use of precast concrete sections might be justified. Mr. Njoroge commented that the ministry of Agriculture has had success with closely spaced drop structures (e.g. 1 m apart) consisting of two rows of poles with stones in between. These structures are satisfactory provided that the slope length is not more than 0.5 km and discharge is small. The centre of the structure should be low enough to allow people to pass and the sides (shoulders) should be high enough to prevent runoff cutting round.

Paper 21 by Mr. Trojanow

Mr. Njoroge enquired how the Ministry of Water Development and the Ministry of Agriculture coordinate their activities in water conservation so as to avoid duplication of effort, and particularly since the Ministry of Agriculture has a Mechanisation Branch which supervises the construction of masonry weirs. Mr. Trojanow agreed that cooperation between the two ministries was most desirable and that efforts should be made to exchange information on their activities to be followed by combined action in areas where erosion is a serious problem within the catchment of a planned dam or pan.

Paper 23 by Mr. Werner

Mr. Adamson asked how long the sand filter system had been in operation, what maintenance is expected and its eventual life span. Mr. Werner stated that the reservoir had been in operation for about 4 months and that very little maintenance would be required. The problem of maintenance would be more of a logistical nature than financial. The life span should be competitive with the conventional systems but a yield reduction should be expected. Mr. Adamson enquired whether people rationalise between the water sources available at the dam, i.e. between the good filtered water and the untreated water which goes to the stock trough. Mr. Werner claimed that the people do distinguish between the two water sources and no instances of misuse have been recorded. Mr. King asked how much water was stored by the reservoir. Mr. Werner replied that the average gross storage capacity is in the range of 20,000 to 200,000 cubic meters for small dams.

Paper 24 by Messrs Smith and Critchley

Mr. Norman asked how the maintenance problems of small earthworks on rangeland were overcome. Mr. Smith commented that this question raised the very important problem of land adjudication - especially in respect to soil conservation and rehabilitation work in rangeland. The work carried out so far in the Njemps Flats had been confined to demonstration techniques in thorn-fenced areas which were maintained by paid labour. The area is now in process of being adjudicated into large 'group ranches.' Mr. Smith was not very optimistic about the viability of these group ranches, but hoped they would lead to increased awareness of the need to exercise good stewardship of the rangeland. Mr. Thomas raised the question of how weeding between crop rows affected runoff harvesting. Mr. Smith mentioned that they were planning to plant (without cultivation) a row of legumes half-way between the ridges after establishment of the sorghum. The remaining area is then weeded as necessary by light hoeing with a jembe. Although this disturbs the soil and so decreases the runoff slightly, after one good shower of rain, the soil caps over again permitting runoff to be harvested.

Paper 25 by Mr. Barrow

Mr. Norman asked whether disturbance of the soil in making microcatchments led to the danger of increased erosion.

Mr. Barrow emphasized the need for the bunds to be well compacted, and for stones to be used if available. Dr. Huxley requested more information on how individual species responded to the micro-catchment effects. In reply Mr. Barrow said that in general the indigenous trees had a higher survival rate, and a slower growth rate, whereas the exotic species had a lower survival rate but a higher growth rate. Some of the more successful species were Azadirachta indica, Atriplex nimularia, Acacia aneura, Acacia tortilis, Acacia halosericea and Prosopis spp. Leucaena was now considered less suitable because the climate is too dry. Mr. King enquired where the trees listed in the paper could be seen and whether Euphorbia spp had been tried? Mr Barrow explained that the trees could be seen at Kositei Catholic Mission which is 10 km from Nginyang, which is 70 km north of Marigat. Euphorbia spp. had only been tried as fencing and hedging material.

Paper by Dr. Michieka

Mr. Sindiga commented that no-till farming requires continuous pesticide applications, and asked whether this might result in the development of new pests. Dr. Michieka replied that many of the herbicides now used are broken down into non-active metabolites, but the repeated use of certain pesticides could result in this problem.

Paper by Mr. Mutiso

Mr. Kimanthi commented that Besides erosion and leaching resulting in a loss of fertility, the continuous harvesting of crops without fertilisation will also lead to a gradual decrease in fertility.

Paper by Dr Huxley

Mr. Barber enquired how effective a woody mulch would be on steep slopes compared to a grass mulch. Dr Huxley replied it would probably be less effective but this needs to be investigated. Mr. Norman asked whether the use of human excrement and rubbish in mulching/fertilisation practices had been considered. Dr Huxley said they would be used if composted and provided attention is paid to health hazards. These materials are commonly used in S.E. Asia. In general, there are a number of problems in using mulch, especially woody mulch, which are dealt with in the paper.

Paper by Mr. Muchiri

Various participants asked where they could obtain the tools that Mr. Muchiri was recommending and at what price. Mr Muchiri replied that the tools were going into farmer acceptance trials and if satisfactory would be given to a manufacturer. Dr Huxley commented that with zero tillage it is possible to do early planting but that too early planting may lead to poor germination. On the other hand too late planting may lead to good germination but poor yield due to moisture stress in the latter period. There may be a tendency to follow too much and "either/or" approach to tillage/no tillage. Mr. Ruttoh asked if the 26% possible crop failure is applicable to maize only or to other crops as well. If not, can a similar theory be applied to other crops. Mr Muchiri said that the model discussed was for Katumani Composite maize and that other crops would require different models specific to their requirements.

VISIT TO MACHAKOS DISTRICT

By

Dr. J.P. Mbuvi

On Saturday March 13th 1982, participants travelled to Machakos where they were joined by Mr. M. Zobisch, Mr. Mbuthia and Mr. V.W. Werner of the Machakos Integrated Development Programme (MIDP). The participants were taken to see various soil and water conservation activities in different localities as described below.

1. MBUUNI, MUPUTI LOCATION

- a) At Mr. Litwe Kimeu's shamba near Mbuuni the participants saw some well made bench terraces which the farmer had constructed himself. However, the participants observed that the farmer had not established grasses to stabilise the walls of the terraces. The farmer agreed to plant grasses to stabilise the walls and also to renew the existing terraces in his coffee shamba.
- b) The MIDP project near Mbuuni Primary School is aimed at reclaiming a small badly eroded catchment area to demonstrate to the local population what they can do for themselves. This project was started in 1981 with 11 farmers contributing the land. The reclamation work is carried out by the local population with the fencing material supplied by the MIDP. This project will run for 3 years then the land will be handed back to its original owners. The participants were shown various methods of gully reclamation and the revegetation of denuded land. The participants observed that for the programme to succeed well, grasses must be re-established through reseedling. The problem of capping in the soils there does not encourage the natural revegetation of grasses.

2. KAMWELENI MUPUTI LOCATION

At Kamweleni Mr. Thomas showed the participants the use of erosion pins installed in 1980 for estimating the rate of erosion. Participants were able to see for themselves the rate at which erosion has been going on (mainly surface erosion). A postgraduate student worked in the same place to establish grasses. This was quite successful and showed that fertility does not prevent revegetation. However much ground still remains bare and unless the surface seal is broken to encourage infiltration and reseeded is done the land will continue to erode as it has been doing for many years.

3. MAKAVETE, KALAMA LOCATION

Near Makavete, Mr. Kitolo Mwangi showed the participants the storage tank he had built in order to catch the water from his roofs. He also explained to the participants how he has maintained his farm to avoid soil erosion since 1939. The participants saw Mr. Mwangi's subsurface dam on the Syuuni river and noted that many more people should be encouraged to construct such subsurface dams to ensure a constant supply of water.

4. MAKULANI, KALAMA LOCATION

MIDP has constructed an earth dam at Makulani in Kalama Location which is serving the local community there. This dam is well protected from animals and the conservation work on the catchment ensures that the dam will not silt quickly. Arrangements for the reclamation of the borrow area and for drawing off water for people and animals are excellent. However, the participants noted with some concern the erosion being caused by the spillway and felt that some measure should be taken to correct this. The participants also noted the very high cost of such projects.

5. KATUMANI

The final visit was to the National Dryland Agricultural Research Station, Katumani. Here Mr. L. Ulsaker showed participants runoff plots for determining soil erodibility 'K' values. As the plots had only been established in 1981, not enough data had been collected to indicate what the 'K' values were likely to be. However, it was felt that such data would help in planning conservation measures that take account of variations in soil erodibility and rainfall erosivity in different parts of the country.

VISIT TO MURANGA DISTRICT

By

Mr. S.I.O. Owide

Mr. S.I.O. Owide

On Thursday afternoon 11th March, 1982, the workshop participants went to Kandara Division in Murang'a to observe and study the soil and water conservation problems in this area. On arrival at Kandara the party was met by Messrs: Otvera, Ndaba and Arap Too, and later by the District Agricultural Officer Mr. J.M. Gitau. The party was taken round the Division and stopped at various places of interest as described below.

1. THIKA/RUCHU RIVER CONFLUENCE:

The first stopping point was near the confluence of Thika and Ruchu Rivers. The party took lunch beside the river. After lunch the District Agricultural Staff gave introductory speeches about the Division.

Kandara Division is roughly 416 km² in area and altitude varies between 1,680 m and 2,130 m above sea level. There is more rain in the upper zones than in the lower zones. The average land holding in the lower zones is 1.2 ha. and in the upper zone this can go up to 10 ha. There is therefore a big population pressure in the lower zone which is also the coffee growing area. Because of the intensive cultivation on steep slopes of the lower zone, soil erosion problems are greater in this zone than in the upper areas. There are two rainy seasons both in the lower and upper zones. The crops grown in the division include coffee, maize, potatoes and beans.

Several soil and water conservation problems exist in the area and these were given by the District Agricultural staff as follows:-

- a. High cost of reclamation of eroded land.
- b. Most access roads run downhill and therefore encourage gullying along the roads as a result of high runoff.
- c. Road construction works direct roadside drainage water into farms causing erosion and loss of top soil. Gullies result which are difficult to reclaim.
- d. Most cultivation is done on steep land, some of which has slopes over 70%.

This has enhanced erosion where no conservation measures are taken. Even where conservation measures are taken the problem of landslides is still a menace.

The participants then engaged into a discussion about the difference in silt contents between the Thika and Ruchu rivers. Where the Ruchu river joins the Thika there is an obvious difference in water colour: Ruchu water is brown while Thika water is clear. This difference exists throughout the year and rainfall in the upper reaches of the Ruchu and not of Thika cannot explain this difference. A number of ideas were brought forward to explain the differences: viz:

- a. **Thika river is in** a mature stage and passes over hard bed rock. Erosion is therefore slow and no silt is carried in the water. Ruchu river is youthful and is still eroding its bed before it reaches the rock. This therefore means a lot of soil eroded is carried in suspension. More sediment is carried in the river during heavy rains when catchment run off also contributes to the Ruchu river flow.
- b. There is more activity upstream of the Ruchu river than there is along the Thika river. Such activities includes, cattle watering and cultivation along the river. It was noted however that, the farmers had not cared to practice zero grazing because of lack of grazing land and that other agricultural activities along the two rivers is more or less the same.

- c. The Thika river has its source in the Aberdare mountains and this renders it cleaner than the Ruchu which has its origin in, and flows through, the farm lands of Murang'a.

No conclusions were reached and the difference in silt content of the two rivers remains an interesting research subject.

2. NEAR KIAMWATHI SCHOOL

Here the party stopped to study a gully caused by road drainage; erosion and soil conservation in coffee farm; and deposition of eroded soil in a swampy environment and extension of cropping land into swamp.

When the road passing in front of Kiamwathi School was constructed, the natural drainage patterns were altered. Several water courses were closed and their flows diverted to one course. At times of rain a lot of water therefore flows in a channel in which only a small fraction of the flow would have followed. The result is that erosion starts and a gully is formed.

The gully formed below Kiamwathi School discharges sediment into a swamp further below. As the swampy ground silts up year after year, more land is reclaimed for cropping, and some farms below Kiamwathi School have extended their boundaries, into the swamp. The farmers are therefore gaining more land without much effort in terms of reclamation. The coffee farms below Kiamwathi School present examples of both good and bad soil conservation on sloping land. The land slope here is about 35% and the farmers have constructed bench terraces on which coffee trees are grown. One farmer had maintained his terraces very well by keeping narrow grass strip along the edge of the benches. As a result, the coffee crop was very healthy and no signs of erosion were noticed. The neighbouring farmer had not cared to maintain his terraces and as a result the benches and their edges are broken and the top soil has been washed away in several places.

The coffee crop was as not very healthy and if nothing is done the farm may cease production in only a few years.

3: NEAR MUKURWE

The party visited this place to see cut-off ditches constructed in 1978; a landslide in 1981; terracing on steep slopes; and early conservation measures to control gullying.

The slope of land near Mukurwe exceeds 55% and there is intensive farming being done, with coffee being a major crop. The farmers here also grow vegetables, maize and potatoes. Some good conservation measures have been taken and no signs of gullying was noted. However, because of the steep slopes, cut-off drains have been dug but do not discharge into a waterway. During heavy rains, the cut-offs retain water and allow greater time for infiltration. The soil therefore absorbs a lot of water resulting in increased weight and decreased stability. This was the case in 1981. As a result a portion of land in one farmer's field was lost by landslide. Terraces, trees and crops were all swept down-slope into the valley.

One problem noted in this area is that the soil structure is very weak. The cut-off drains therefore cave in after a short time and they have to be maintained frequently.

It was noticed while at Mukurwe that farmers are concerned more with soil conservation on coffee farms than where other crops are grown. This is probably because coffee is more profitable than other crops. It may also be that farmers in such areas in Murang'a were required to construct bench terraces before they could be licenced to grow coffee, particularly during the Colonial days and that they got used to the idea and practiced it up to the present time.

While at Mukurwe, the shortcomings of the Agricultural Act were noted. The Act does not allow cultivation on slopes more than 35%. Around Mukurwe and elsewhere in Murang'a, farmers are cultivating on slopes approaching 70% using conservation measures. They are producing both subsistence and cash crops. The question was raised as to ealiar should be done to help these farmers who have no other piece of land except on the steep slopes.

4: GACHARAGE - KANDARA ROAD

a. Gully Reclamation

At this point the party had a look at control works on a gully that has been caused by road runoff water. The catchment area is the road surface which itself is totally impervious so that when it rains therefore all the water runs down the slope. The consequence was a narrow but deep gully.

The Ministry of Agriculture had tried to control the gully but the expense seemed high. Already KShs. 15,000/= had been spent and the control was not complete. Gabions, stone check dams and wooden check dams had been constructed but erosion was still taking place. The participants suggested that either a grassed waterway or a stone lined channel be made to control erosion by the road runoff.

It was noted while at this point that whereas in principle the Ministry of Transport and Communication, which is in charge of road construction, is supposed to take care of runoff from the roads, in practice they do not care. Due to this negligence the farmer is the ultimate sufferer, in that the water ends in his farm, carrying away the top soil and causing gullies. The participants were informed of a farmer who was fined in Court after being found guilty of re-directing road water coming out of a culvert so that the water could not affect his farm. It is therefore evident that the farmer is not protected in such cases.

b. Road Embankment Protection

The participants were shown the Kandara - Gacharage road embankment protection worked by Mr. Shimich of Put Sarajevo Construction Company, a Yugoslavia firm. The embankment is made to protect the road from being undermined by a river flowing down below or by erosion on the slope. The retaining wall was constructed with 6 layers of gabions with a total volume of 1725 m³ and placed in an arrangement that improved the slope from the original 1:1 to a new slope of 1:4. Soil stabilization was done by compacting with rollers. At a point where runoff is discharged from the road, a stone lined waterway of a total of 105 m² had been constructed. It was noted, however, that erosion was not totally checked by the stone lined waterway. The whole engineering exercise cost an amount of K.Sh. 1.8 million, a massive investment.

CONCLUSIONS AND RECOMMENDATIONS

On Friday March 12th, participants split into four groups for discussion of specific problems relating to four main topics namely: 1. Evaluation and monitoring; 2. Technical recommendations for humid areas; 3. Technical recommendations for dry areas; and 4. Extension strategy. Reports from each group were presented to a plenary session in the afternoon and the following is a summary of the main recommendations and conclusions.

1. Evaluation and Monitoring

The group examined the question whether environmental degradation is increasing or decreasing and noted that evidence for environmental degradation was mainly visual and qualitative and that much more quantitative data was needed. However, measurements have shown accelerating rates of erosion on grazing land in Amboseli, increasing sediment loads in the Athi and Tana rivers and decreasing crop yields per mm of rain in Machakos. The group emphasised the importance of accuracy and reliability in data collection and the need to relate data on land erosion to river sediment loads and water quality. Further data is needed on current and potential erosion rates and processes, river flow rates and sediment loads, land use changes (including losses to roads, etc.) as well as changes in vegetation cover and livestock and human populations. One important gap in data concerns the relative importance of different erosion processes and the type and effectiveness of conservation measures which are being employed. The Soil Conservation Branch of the Ministry of Agriculture was considered the proper body to collect this information.

The group recognised the important contribution being made by the Ministry of Agriculture Arid and Semi Arid Lands Branch, the Kenya Soil Survey, the Kenya Rangeland Ecological Monitoring Unit, the Central Bureau of Statistics, Survey of Kenya, the Remote Sensing Facility and the Institute for Population Studies, in collecting data but agreed that there was a need to collect and evaluate more comprehensive data for both humid and semi arid areas. It was recommended that data should be

collected and evaluated on a national scale to focus attention on problem areas. Within these areas, detailed studies should be carried out at a catchment and field level to determine the causes of land degradation and the processes involved. The group suggested that the National Environmental Secretariat should be responsible for developing the methodology to be used and for integrating and evaluating the studies carried out.

2. Technical Recommendations for Humid Areas

This group considered the need for waterways and the problems arising from uncontrolled discharge from roads. It was noted that farmers get no compensation for damage to land and there is sometimes confusion over which authority is responsible for maintenance of unclassified roads. The group recommended that road building contracts should include proper arrangements for the discharge of runoff. Maintenance units should be concerned with waterways as well as road reserves and should take action to control road-side gullies when necessary. Mitre drains should not discharge directly onto cropland but should be channelled to a grassed area or waterway. Where waterways are needed to drain water from agricultural land as well as from roads there should be coordination between the Ministry of Agriculture and the Ministry of Transport and communications. Due to shortage of land in high potential areas such waterways must be carefully designed and the Ministry of Agriculture, Soil Conservation Branch, should examine the cost effectiveness of designs employing grass, stone lining and drop structures, with a view to standardising recommendations for different situations. The group noted the increasing number of gullies in high potential areas, due in part to road drainage and foot paths and recommended that the Ministry of Agriculture's Soil Conservation Branch should review methods and costs of gully control and reclamation and possible ways of utilisation.

The problem of mass movement appears to be on the increase in certain areas and there is a need for investigation into the causes of movement and control measures. Mass movement is often associated with removal of trees and excess water in the soil profile. On land which is susceptible to mass movement on account of soil type, slope or rainfall, the methods of conservation employed

should promote the drainage rather than retention of water and the planting of deep rooted indigenous trees should be encouraged. The use of level bench terraces and level cutoff ditches should be avoided in these situations.

The group noted that farmers need more advice and assistance in the development of seasonally waterlogged and, swampy areas.

A general recommendation was made for setting up machinery whereby policy recommendations on soil and water conservation could be reviewed regularly and revised where necessary in the light of research findings and field experience.

3. Technical Recommendation for Dry Areas

This group discussed alternative conservation practises for use in the semi arid areas and noted several matters where uncertainty exists and investigation is needed. Contour ridging was thought to be useful on relatively level ground but the optimum spacing of ridges and plants needs investigation. Procedures for terracing were discussed and it was agreed that the 'fanya juu' method of throwing soil uphill to form a bank is the most appropriate for the dry area as it can lead to the formation of level bench terraces and greater retention of water as well as soil. However, several problems were identified as needing research. Firstly the suitability of different grasses for terrace banks and their competitive effect on adjacent crops, second the advisability on stony land, of removing stones from the surface (where they intercept rain, retard runoff and reduce evaporation) and using them to form terrace banks, and third the conservation measures which are appropriate for steep slopes. There is an urgent need to explore most profitable ways of utilising steep slopes in different ecozones. Although level (end to end) terraces for retaining water appear to be most suitable in dry areas, the group considered that there must be an upper slope limit depending on soil type and other factors above which terraces should be graded due to the risks if failure occurs. Further investigations on this are needed.

The group noted that erosion on rangeland is aggravated by increasing population overstocking and lack of land adjudication. The advantages and disadvantages of group ranches as opposed to individual holdings in achieving better management needs to be studied and further investigation is needed on the relation between overgrazing, burning, shifting cultivation, game movement and soil erosion.

The group considered wind erosion to be a problem with crop production in certain areas and recommended the use of tree species such as Euphorbia tirucalli, Leucaena leucocephala and Prosopis chilensis for windbreaks. The use of perennial grasses to protect land subject to wind erosion was also considered important.

The group recommended that an ad hoc National Advisory Committee should be set up to review soil conservation problems in semi arid areas. Mr. L. Ulsaker, Physics Dept., Kenya Agricultural Research Institute, agreed to edit an informal newsletter which would act as a forum for exchanging ideas and information on soil and water conservation in semi arid areas of Kenya.

4. Extension Strategy

The group recommended that all organisations involved in soil and water conservation should work towards improving the farmer's understanding of the need for conservation and his ability to carry it out with his own resources. There is a need to increase motivation among farmers and to introduce technology in a way which will lead to greater self reliance.

The benefits of conservation both in the short and long term should be made clear to farmers and all institutions involved in education should help to disseminate information on resources conservation. Agriculture should have a place in the curriculum of all schools and the development of a 'resource conservation philosophy' which is essential to the future well being of the country should be considered a major goal of education.

The group noted the need to improve the capability of extension staff and to promote closer contact with farmers. There is also a need to coordinate the activities of extension officers, produce authorities and large companies organising the production of crops such as barley and tobacco.

5. General Recommendations of the Plenary Session

The conference noted the lack of a clear land use policy that could provide guidance on the proper use of soil and water resources, the allocation of land for forest purposes etc, and recommended that the Permanent Presidential Commission on Soil Conservation and Afforestation should be given responsibility for working out such a policy. The need was emphasised for co-ordinated efforts at soil and water conservation on a catchment basis so that proper arrangements are made for water storage and flood control as well as for soil conservation. Ways and means of improving infiltration and reducing runoff losses in drier areas was recognised as a topic of major importance.

The conference noted that more research is needed but that it should wherever possible be carried out by multidisciplinary teams, form part of a farm systems approach and have an extension arm for testing new methods at the farm level. The conference recommended the establishment of a coordinating committee on soil and water conservation to define longterm objectives, decide priorities for action and to carry out, at regular intervals, a review of problems and recommendations in the light of research findings and field experience. Such a committee should have representation from the various government and non-government agencies concerned with soil and water conservation and should be organised and administered by the Permanent Presidential Commission on Soil Conservation and Afforestation. Periodic seminars or workshops should be organised to bring together those involved in soil and water conservation.

WORKSHOP PROGRAMME SUMMARYWEDNESDAY MARCH 10TH

- 8.30 Registration
- 9.00 Opening Address by Dr. D.N. Ngugi, Dean,
Faculty of Agriculture, Kabete Campus
- 9.30-10.45 First Session - Presentation of Papers
- 11.00-12.45 Second Session - Presentation of Papers
- 2.00- 3.45 Third Session - Presentation of Papers
- 4.00- 5.30 Fourth Session - Presentation of Papers.

THURSDAY MARCH 11TH

- 9.00-10.45 Fifth Session - Presentation of Papers
- 11.00-12.15 Sixth Session - Presentation of Papers
- 12.30- 5.30 Field Trip to Kandara Division, Muranga District.

FRIDAY MARCH 12TH

- 9.00-10.45 Seventh Session - Presentation of Papers
- 11.00-12.45 Group Discussions
- 2.00- 3.45 Group Discussions
- 4.00- 5.30 Final Session - Reports from Groups
- 5.30- 6.30 Closing Address by Prof. J.M. Mungai,
Vice Chancellor, University of Nairobi
- 6.00- 7.00 Reception

SATURDAY MARCH 13TH

- 8.00-5.30 Field trip to Muputi and Kalama Locations
of Machakos District and to Katumani National
Dryland Research Station.

SOIL AND WATER CONSERVATION WORKSHOP, MARCH 1982LIST OF PARTICIPANTS AND ADDRESSES

| | |
|------------------|--|
| Adamson, Charles | Agricultural Planner, Magarini Project, P.O: Box 700 Malindi. |
| Ahn, Peter | P.O: Box 23001, Nairobi |
| Amare Getahun | Ministry of Energy, P.O. Box 62360 Nairobi |
| Aubry, Brian | Research Assistant University of Washington c/o Dept of Geography University of Nairobi, Box 30197, Nairobi. |
| Baraza, E.O. | Mwea Tabere Agricultural Research Station. P.O. Box 298 Kerugoya |
| Barber, R.G. | Lecturer, Dept. of Soil Science University of Nairobi, Box 30197, Nairobi. |
| Barrow, E.G.C. | Project Leader, East Pokot Agric Project, Catholic Diocese of Nakuru, P.O. Marigat. |
| Buruchara, R. | Dept. of Crop Science, University of Nairobi, Box 30197, Nairobi. |
| Charania, S.H. | Chief Hydrologist, Ministry of Water Development, Box 49720, Nairobi. |
| Cheruiyot, R. | Soil Erosion Project, NEHSS, Box 67839, Nairobi. |
| Chuaga, F.M. | Tutorial Fellow, Dept. of Agric. Engineering, University of Nairobi, Box 30197, Nairobi. |
| Chweya, J.A. | Lecturer, Dept of Crop Science, University of Nairobi, Box 30197 Nairobi. |
| Ciera, P.G. | Conservator of Forests, Forest Department, Box 30513, Nairobi. |
| D'Costa, V. | Senior Lecturer, Dept of Soil Science, University of Nairobi, Box 30197, Nairobi. |
| Edalia, F. | Hydrologist, Ministry of Water Development, Box 49720, Nairobi. |

Elegwa, E.D. Graduate Engineer, E.A. Engineering Consultants, Box 30707, Nairobi.

Ellen, H. Lecturer, Dept. of Agric Engineering, University of Nairobi, Box 30197, Nairobi.

Faught, W.A. Team Leader, KARI/USAID Dryland Project, Box 30148, Nairobi.

Filius, P. Agric. Student, MIDP, Machakos DAO's Office, Box 27, Machakos.

Gateri, M.M. Hydrologist, Tana & Athi Rivers Dev. Authority, Box 47309, Nairobi.

Gachene, C. Kenya Soil Survey, Box 14733 Nairobi

Gichuki, F.N. Senior Technician, Dept. of Agric Engineering, University of Nairobi, Box 30197, Nairobi.

Gitau, J.M. DAO, Muranga, Box 68, Muranga.

Goetz, B.A. Student, University of Nairobi Box 30197, Nairobi.

Haack, B. Scientist, Regional Remote Sensing Facility, Box 18332, Nairobi.

Hansen, Jens Agric Volunteer, Machakos Integrated Dev. Programme, Box 662, Machakos.

Hedfors, Lars Advisor Coordinator, Ministry of Agriculture, Soil & Water Cons. Branch, Swedish Embassy, Box 30600 Nairobi.

Holdsworth, I. Jr. Agric. Planner, Ministry of Planning, Box 137, Embu.

Huxley, P.A. Sr. Research Officer, ICRAF, Box 30677, Nairobi.

Isavwa, L.A. Application Specialist, Regional Remote Sensing Facility, Box 18332, Nairobi.

Jacob, C.M. Professor, Dept. of Agric Engineering, University of Nairobi, Box 30197, Nairobi.

Jani, V.Y. Engineer, Conservation Section, Ministry of Water Development,

Kaaya, V. Information Coordinator, Ministry of Agriculture, Box 14733, Nairobi.

Kamau, N.R. Agric Officer, Ministry of Agriculture, Box 84, Nyahururu.

Kamweti, D.M. Lecturer, Dept of Forestry, University of Nairobi, Box 30197, Nairobi.

Karanja, A. Kairu Lecturer, Egerton College, Private Bag, Njoro.

Kariuki, G.T. Agricultural Officer, Magarini Settlement Scheme, Box 700, Malindi.

Kariuki, W.M. Hydrologist, Tana & Athi Rivers Development Authority, Box 47309, Nairobi.

Kenny, O. Women Home Economics & Agric. Extn., G.K., Box 61, Marsabit.

Keya, S.O. Senior Lecturer & Chairman, Dept. of Soil Science, University of Nairobi, Box 30197, Nairobi.

Kilewe, A.M. Research Officer, KARI, Box 30148, Nairobi.

Kimanthi, B. Agronomist, NAL, Box 14733, Nairobi.

King, T. Lecturer, Egerton College, Private Bag, Njoro.

Kirimi, J.H. Supt. Hydrologist, Ministry of Water Development, Box 30521, Nairobi.

Kitheke, S.K. AAO II, Ministry of Agric, Box 340 Machakos.

Konuche, P.K.A. FRD/KARI, Box 74, Kikuyu.

Koske, C. Engineer II, Ministry of Water Development, Box 49720, Nairobi.

Lewis, L.A. NEHSS, Box 67839, Nairobi.

Lundgren, L. Regional Soil Conservation Adviser, SIDA, Box 30600, Nairobi.

Macharia, D.W. Agric Research Officer II, NAL,
Box 14733, Nairobi.

Mackintosh, C.A. Soil Conservation Engineer,
Ministry of Agriculture Box 137, Embu.

Mac'Odawa, G.M. Civil Engineer, Ward Ashcrot and
Parkman (E.A.), Box 41425, Nairobi.

Macodras, M.W. Meteorologist, Kenya Met. Dept.
Box 30295, Nairobi.

Mageto, J.M. Graduate Research Assistant,
Dept. of Agric. Engineering, University
of Nairobi, Box 30197, Nairobi.

Magwaro, C.I. District Land Resources Dev. Officer,
Ministry of Agric, Box 392, Kerugoya.

Mann, I. Kenya Freedom from Hunger Council,
Box 20360, Kabete.

Mansfield, J.E. Land Use Planner, EMI Project,
Ministry of Agriculture, Box 137,
Embu.

Mare, E. Asst. Land Management Officer, Kenya
Soil Survey, Box 14733, Nairobi.

Mbara, C.J. Prov. Land Development Officer -
Coast, Ministry of Agriculture,
Box 90290, Mombasa.

Mbote, F.W. Agric Officer, Ministry of Agriculture
Box 30028, Nairobi.

Mbugua, L.W. Planning Officer, Agric Mechanisation
Station, Box 4, Ruiru.

Mburathi, G.K. Chief Executive, Permanent Presidential
Commission on Soil Conservation and
Afforestation, Office of the President,
Box 30510, Nairobi.

Mburu, C.N. Agric Officer, Ministry of Agric
Box 29, Nyeri.

Mburu, S.G. Lecturer, Dept of Agric Engineering
University of Nairobi, Box 30197,
Nairobi.

Mbuvi, J.P. Lecturer, Dept of Soil Science,
University of Nairobi, Box 30197,
Nairobi.

DeMeester, T. Principal, TPIP, Kilifi, Agric
University Wageningen, Holland
c/o TPIP, Private Bag, Kilifi.

Melville, I.R. Soil Conservation/Land Development Consultant, Magarini Land Settlement Scheme, Malindi, Box 700, Malindi.

Michieka, R.W. Lecturer, Dept of Crop Science, University of Nairobi, Box 29053, Nairobi.

Milimo, P. Assistant Conservator of Forests, KARI, Box 74, Kikuyu.

Misiko, P.A.M. Head, Engineering Department, Egerton College, PO Njoro.

Njoroge, J. INADES - Formation Kenya, Box 14022, Nairobi.

Mohamed, R.R. Engineer, Rofe Kennard & Lapworth, Box 10222, Nairobi.

Muchena, F.N. Head, Kenya Soil Survey, Box 14733 Nairobi.

Muchiri, G. Senior Lecturer & Chairman, Dept. of Agric Engineering, University of Nairobi, Box 30197, Nairobi.

Muchura, Justina Publications Editor, Institute for Development Studies, University of Nairobi, Box 30197, Nairobi.

Mugo, J. Agric Officer II, Box 68, Muranga.

Mukindia, C.R. Provincial Programme Coordinator Ministry of Agric, Box 1912, Kisumu.

Mulwa, A.W. Meteorologist, Box 30295, Nairobi.

Muracia, J.E.K. Agric. Officer II, Provincial Irrigation Unit, Box 470, Nakuru.

Murakaru, S.W. Agriculturalist, Tana & Athi Rivers Development Authority, Box 47309, Nairobi.

Mureithi, N. Field Advisory Officer, Kenya Breweries Ltd, Box 707, Nakuru.

Muriuki, S.K. Tutorial Fellow, Dept of Soil Science, University of Nairobi, Box 29053, Nairobi.

Mutiso, S.K. Graduate Assistant, Dept of Geography, Box 30197, Nairobi.

- Mutulu, P.M. MSc Student, University of Nairobi
Box 30197, Nairobi.
- Mwaniki, D.K. Provincial Land Dev. Officer,
Ministry of Agriculture, Box 530,
Nakuru.
- Mwangi, D.S. Agric. Officer II, Ministry of
Agriculture Box 899, Nyeri.
- Mwendwa, G. Agric Research Officer II, IDRP
(NAL) Box 14733, Nairobi.
- Nduati, J.P. DAO Kirinyaga, Ministry of Agric
Box 392, Kerugoya.
- Ngeno, J.K. Project Coordinator, BSAAP,
Ministry of Agriculture, PO Marigat.
- Ngugi, D.N. Senior Lecturer and Dean, Faculty
of Agriculture, Box 30197, Nairobi.
- Nightingale, G.M. Farmer, Sasumua Estate Ltd,
Box 23, Njoro.
- Nightingale, J.M. Farmer, Sasumua Estate Ltd.
Box 23, Njoro.
- Njihia, C.M. NAL, Box 14733, Nairobi
- Njoro, S.N.J. Coordinator Soil Conservation Ext.
Unit., Ministry of Agric. Box 30028,
Nairobi.
- Norman, J.G.S. Plant Hire Manager, Ag. Mech. Serv.,
Land Development Division, Ministry
of Agriculture, Box 30028, Nairobi.
- Norton-Griffiths, M. Managing Director, Geosystems Lab
Box 30239, Nairobi.
- Nyagah, Charles Nderi D.L.R.D.O., Ministry of Agric.
DAO's Office, Box 70, Nyahururu.
- Nyale, D.M. Technician, Farm Management,
Field Station, University of Nairobi,
Box 30197, Nairobi.
- Nyamweru, C.K. Associate Professor, Kenyatta
University College, Box 43844,
Nairobi.

| | |
|----------------|--|
| Nyandat, N.N. | Ministry of Environment and Natural Resources, Box 30126, Nairobi. |
| Nzioki, M. | Librarian, Egerton College, P.O. Njoro. |
| Obiero, W. | Surveyor, Ministry of Water Development, Box 662, Machakos. |
| Okwach, E.G. | Research Officer, National Dryland Farming Research Station, Katumani, Box 340, Machakos. |
| Olsen, D. | Chief Engineer, COWI Consult, Box 46327, Nairobi. |
| Omolo, A.O. | Provincial Extension & Training Officer, Nyanza, Ministry of Agriculture, Box 1912, Kisumu. |
| Ondenge, G.O. | Environmental Protection Officer, Ministry of Environment & Natural Resources, Box 30126, Nairobi. |
| Onim, J.F.M. | Lecturer, Dept. of Crop Science, University of Nairobi, Box 30197, Nairobi. |
| Owido, S.F.O. | Lecturer, Dept of Engineering, Egerton College, PO Njoro. |
| Owino, F. | Senior Lecturer and Chairman, Dept of Forestry, University of Nairobi, Box 30197, Nairobi. |
| Reid, L. | Geomorphologist, University of Washington, c/o Ecosystems, Box 30239, Nairobi. |
| Rimberia, F.K. | AO, Agric. Ministry, Box 27, Kakamega. |
| Rowntree, K. | Lecturer, Dept. of Geography, Kenyatta University College, Box 43844, Nairobi. |
| Ruttoh, J.K.A. | FAO, KBL, Box 707, Nakuru. |
| Scheltema, W. | Training Officer, Ministry of Agriculture - IDB, Box 30028, Nairobi. |
| Sharman, R. | Project Engineer, Christian Rural Service, CRS, Khasoko Centre, Box 734, Bungoma. |

- Sherill, D. Lecturer, Dept of Geography
Kenya University College
Box 43844, Nairobi.
- Sinda, P.M. Lecturer, Kenya University
College, Box 43844, Nairobi.
- Sindiga, I. Tutorial Fellow, Dept of Geography,
Kenya University College,
Box 43844, Nairobi.
- Sjostrand, Ingvar Soil Conservation Officer - Nurseries.
Ministry of Agriculture, Box 30028, Nairobi.
- Smith, P.D. Baringo Semi Arid Areas Project,
P.O. Marigat.
- Ssali, H. Senior Lecturer, Dept. of Soil Sc., Univ. of
Nairobi, Box 30197, Nairobi.
- Ssesanga, S.M. Postgraduate Student, Soil Science
Department, Box 29053, Nairobi.
- Stewart, J.I. Agrometeorologist, USDA/USAID/KARI,
Box 30261, Nairobi.
- Strachwitz, T. G. Soil & Water Conservation Engineer,
FAO, UNDP, Box 30218, Nairobi.
- Stromquist, L. Professor. Uppsala University,
Sweden, Box 554, Uppsala, Sweden.
- Tefera, F. MSc. student, Dept. of Agric. Engineering
University of Nairobi, Box 30197,
Nairobi.
- Thomas, D.B. Senior Lecturer, Dept of Agric Engineering
University of Nairobi, Box 30197,
Nairobi.
- Tomkinson, E. Sangalo Institute, Box 158, Bungoma.
- Trojanow, M. Head, Agric. Service Division, Ministry
of Water Development,
Box 30521, Nairobi.
- Ulsaker, L. Soil Scientist, USAID/USDA/KARI
Soil Physics, KAR, Muguga,
Box 30261, Nairobi.
- Wagner, J. Soil & Water Eng., ASAL, Box 67266,
Nairobi.
- Wahome, E.K. Range Ecologist I. KREMU,
Box 47146, Nairobi.

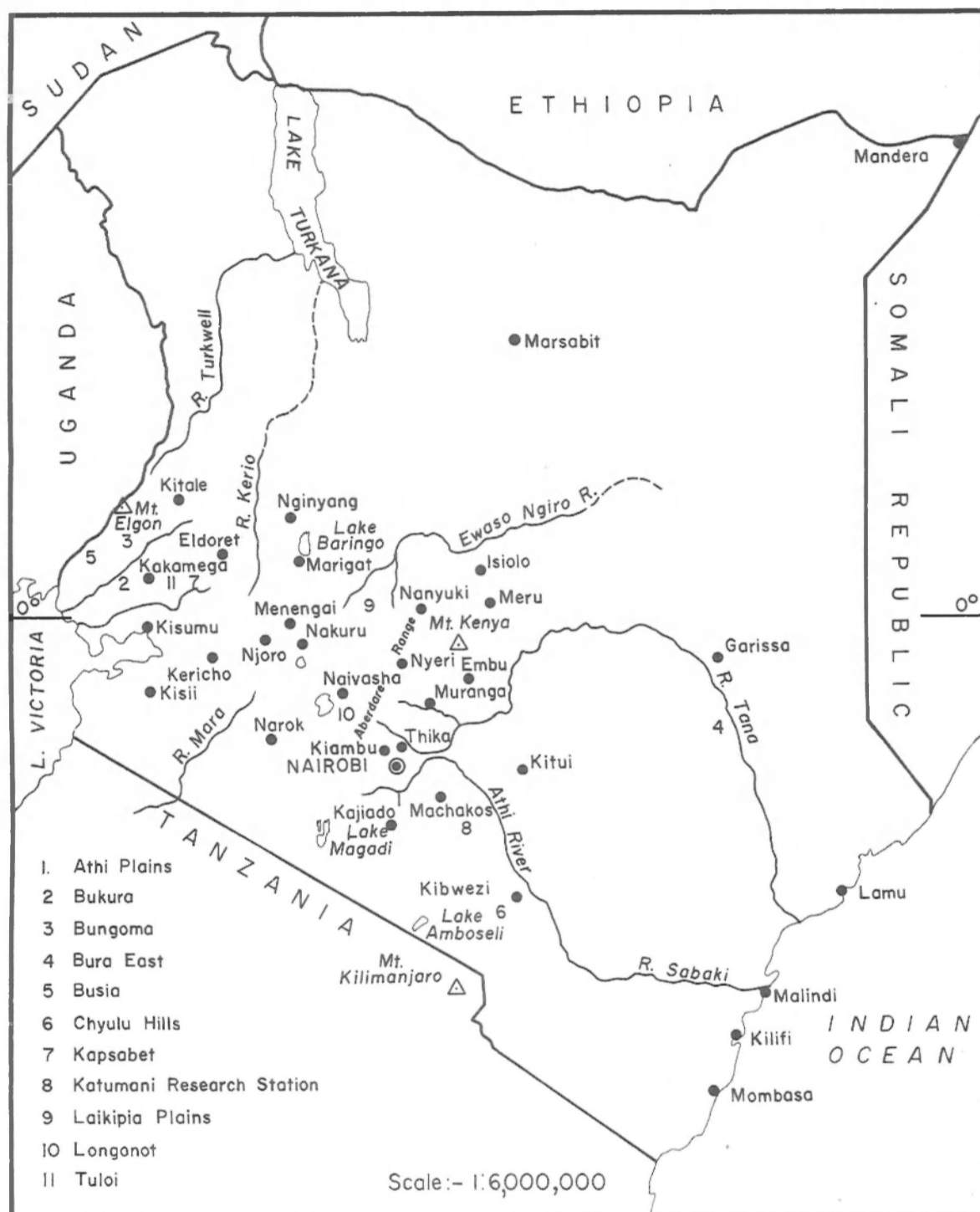

MAP OF KENYA SHOWING LOCATION OF PLACES MENTIONED IN THE TEXT