

PROCEEDINGS SERIES

NATURALLY OCCURRING  
RADIOACTIVE MATERIAL  
(NORM V)

PROCEEDINGS OF THE  
FIFTH INTERNATIONAL SYMPOSIUM ON  
NATURALLY OCCURRING RADIOACTIVE MATERIAL  
ORGANIZED BY  
THE UNIVERSITY OF SEVILLE  
IN COOPERATION WITH  
THE INTERNATIONAL ATOMIC ENERGY AGENCY,  
THE SPANISH NUCLEAR SAFETY COUNCIL  
AND THE UNIVERSITY OF HUELVA  
AND HELD IN SEVILLE, 19–22 MARCH 2007

POSTERS

INTERNATIONAL ATOMIC ENERGY AGENCY  
VIENNA, 2008



# CONTENTS

## POSTER SESSION 1

- 1.1. NORM–ALARA ( $EAN_{\text{NORM}}$ ) — a new module of the European ALARA Network (EAN)  
*H. Schulz, R. Gellermann, L. Geldner, S. Mundigl*
- 1.2. Assessment of TENORM sources in Slovenia  
*B. Smodis, U. Repinc, L. Benedik*
- 1.3. REDRADNA: the Spanish network on natural radiation  
*L. Quindós, C. Sainz, I. Fuente, L. Quindós-Lopez, J. Arteché*
- 1.4. Regulatory aspects on NORM/TENORM activities in Malaysia  
*I.L. Teng*
- 1.5. State of the art of the problems of NORM in Ukraine  
*B. Zlobenko*
- 1.6. Occupational and public exposure due to naturally occurring radioactive materials (NORM) activities in France  
*N. Pires, T. Doursout, G. Lorient, A. Rannon, B. Cessac, A. Despres*
- 1.7. Recording of legacies in the German raw phosphate processing  
*A. Reichelt, J. Gerler*

## POSTER SESSION 2

- 2.1. Evaluation of occupational exposure to naturally occurring radioactive materials (NORM) in the Iranian ceramics industry  
*N. Fathabadi, M.V. Farahani, S. Amani, M. Moradi, B. Haddadi*
- 2.2. A method to evaluate direct gamma-spectrometric measurements of NORM samples  
*J. Mantero, S. Hurtado, G. Manjón, R. García-Tenorio*
- 2.3. Improvements in the liquid scintillation counting techniques for the measurement of NORM samples  
*F. Mosqueda, M. Villa, G. Manjón, F. Vaca, J. Pates*
- 2.4. Development of a radon-aerosol system for testing radon and radon decay products measuring instruments  
*M. Calamosca, S. Penzo, A.O. Mustapha*
- 2.5. Estimation of the radiological risk related to the presence of radon-222 in a hydrotherapy centre of Tunisia  
*F. Essafi, S. Labidi, H. Mahjoubi*
- 2.6. Natural radioactivity of building material in South Africa  
*I. Louw, A. Faanhof*

### POSTER SESSION 3

- 3.1. Radiological impact of a coal-fired power station in Spain  
*A. Baeza, D. Cancio, J.A. Corbacho, J.C. Mora, B. Robles, A. Suárez*
- 3.2. Integrated assessment of possible detrimental effects caused by TENORM  
*B. Michalik*
- 3.3. Fractionation of <sup>226</sup>Ra and <sup>228</sup>Ra in waste material of coal mines and coal fired power plants and the effect of speciation on plant uptake  
*E. Bokori, B. Michalik, L. Juhász, G. Trabidou, I. Chmielewska*
- 3.4. Natural radioactivity status in mining settling ponds: bioaccumulation of radium in biota and the derived dose  
*G. Trabidou, B. Michalik, E. Bokori, I. Chmielewska*
- 3.5. Bioindication-based approach on integrated assessment of natural radionuclides impact on biota in post-mining areas  
*S. Geras'kin, B. Michalik, N. Dikareva, A. Oudolova, S. Chatupnik, V. Dikarev, M. Wysocka*
- 3.6. New underground treatment installation for radium removal  
*S. Chatupnik, M. Wysocka, K. Jarosz*
- 3.7. Availability of radium isotopes and heavy metals from scales and tailings of Polish hard coal mining  
*K. Leopold, B. Michalik*
- 3.8. Alpha emitting radionuclides in drainage from Quinta do Bispo and Cunha Baixa uranium mines into rivers (Portugal)  
*Fernando P. Carvalho, João M. Oliveira, Isabel Faria*

### POSTER SESSION 4

- 4.1. Estimates of occupational exposure to TENORM in a phosphoric acid production plant in Iran  
*N. Fathabadi, M.V. Farahani, M. Moradi, B. Haddadi*
- 4.2. Occupational exposures in a fertilizer industry located at Huelva (south-western Spain)  
*J.P. Bolívar, J.P. Pérez-Moreno, J.E. Martín, J.L. Mas, E. Borrego*
- 4.3. Phosphogypsum as a building and construction material in tropical countries — radiological implications  
*V.M. Jacomino, W. Britto, M. Canut, M.I. Yoshida*
- 4.4. Remediation interventions in Italian industrial sites contaminated with NORM from the phosphate industry: law provisions, criteria and methods  
*M. Paganini Fioratti, L. Magro, C. Nuccetelli, S. Risica, C. Simeoni, G. Torri, R. Trevisi*
- 4.5. Collective dose for the Netherlands and Belgium from a phosphorous plant: committed ingestion dose from farmland and influence of the weather  
*C. Tanzi*
- 4.6. Dispersion of radionuclides through the Ebro river lower course ecosystem beyond the Flix Reservoir  
*N. Casacuberta, P. Masqué, J. García-Orellana, J.M. Bruach-Menchén, J.A. Sánchez-Cabeza, A. Palanques, J.O. Grimalt*
- 4.7. Radium and uranium isotopes in Spanish phosphogypsum leachates  
*J.L. Aguado, J.P. Bolívar, R. García-Tenorio*

## POSTER SESSION 5

- 5.1. Conceptual use of NORM as primary shielding for radioactive wastes  
*A.S. Paschoa, J.M. Godoy, L.E.S.C. Matta, H. Evangelista*
- 5.2. Identification of NORM industries at the entrance of a steel factory  
*L. Quindós, C. Sainz, I. Fuente, L. Quindós-Lopez, J. Arteché*
- 5.3. NORM radiological control of wastes produced by a steel recycling factory in the south of Spain  
*J. Mantero, C. Manjón, R. García-Tenorio, S. Hurtado, M. Villa, M.C. Jiménez, I. Vioque, J. Díaz*
- 5.4. NORM in drinking water, removal and radioactive waste generated  
*F. Schönhofer*
- 5.5. Radiochemical characterization of the sludge from a treatment plant of potable water  
*M. Palomo, A. Peñalver, C. Aguilas, F. Borull*
- 5.6. NORM waste disposed in an underground salt mine  
*J. Dörfel*

## POSTER SESSION 6

- 6.1. Activity ratios of natural radionuclides as markers of changes in the policy of NORM wastes released by industries located in the south-west of Spain  
*E.G. San Miguel, J.P. Bolívar, R. García-Tenorio*
- 6.2. Modelling NORM in the environment: the EMRAS project  
*R.S. O'Brien, P. Waggitt, T. Zeevaert, D. Pérez Sánchez, V. Koukoulidou, J. Horyna, E. Quintana, L. Tsatsi, P. McDonald, L. Setlow*
- 6.3. Dicalcium phosphate: content of uranium decay series  
*N. Casacuberta, P. Masqué, J. García-Orellana, J.M. Bruach-Menchén, J.A. Sánchez-Cabeza, M. Villa, S. Hurtado, G. Manjón, R. García-Tenorio*
- 6.4. Sequential determination of U and Th isotopes and Ra-226 by alpha spectrometry in phosphate fertilizer samples and phosphogypsum  
*C.H.R. Saueia, B.P. Mazzilli, M.H.T. Taddei*
- 6.5. Characterization and modelling of naturally occurring radioactive material releases from a phosphogypsum disposal area in Greece  
*D. Pérez-Sánchez, V. Koukoulidou, K. Kehagia*
- 6.6. Estimation of the amount of anthropogenic uranium in 112 Japanese agricultural soil samples due to application of phosphatic fertilizers  
*S. Uchida, K. Tagami*
- 6.7. Natural radioactivity components in solid waste produced by the manufacture of phosphatic fertilizer  
*I. Vallés, X. Ortega, I. Serrano, A. Camacho, M.A. Duch*

## POSTER SESSION 7

- 7.1. Rapid methods for the determination of natural radionuclides in waste waters from a phosphogypsum waste repository site  
*R. Rusconi, M. Forte, G. Abbate, M.T. Cazzaniga, G. Sgorbati*
- 7.2. Extensive radon-222 exhalation measurements in phosphogypsum stacks from south-western Spain using charcoal canisters  
*J.M. Abril, R. García-Tenorio, S. Enamorado, S. Hurtado, I. Vioque, J. Mantero*
- 7.3. Radium-226 transfer factors for various crop samples collected in Japan  
*K. Tagami, S. Uchida*
- 7.4. Identification of technogenic contamination by natural radionuclides  
*I.V. Yarmoshenko, A.A. Ekadin, M.V. Zhukovsky, A.D. Onischenko*
- 7.5. Radon levels at a NORM storage site  
*L.S. Caccuri, M.P. Campos*
- 7.6. Fluxes and enhancement of natural radionuclides in a pulp mill factory located in the south-west of Spain  
*F. Vaca, G. Manjón, M. García-León, G. Mora, R. García-Tenorio*

# **NORM-ALARA (EAN<sub>NORM</sub>) - a new module of the European ALARA Network (EAN)**

Hartmut Schulz<sup>a</sup>, Rainer Gellermann<sup>b</sup>, Lars Geldner<sup>c</sup>, Stefan Mundigl<sup>d</sup>

<sup>a</sup> IAF - Radioökologie GmbH, Dresden, Germany (IAF)

<sup>b</sup> HGN Hydrogeologie GmbH, Braunschweig, Germany (HGN)

<sup>c</sup> Robotron Datenbank-Software GmbH Dresden, Germany (RDS)

<sup>d</sup> European Commission, Luxembourg (EC)

**Abstract:** In 1996, the European Commission (EC) initiated the creation of a European ALARA Network (EAN) to specify European research on topics dealing with optimisation of all types of occupational exposure, as well as to facilitate the dissemination of good ALARA practices within all sectors of the European nuclear industry and research. Up to now the NORM sector was not explicitly included in this network. Therefore, in the next two years it is planned to develop an ALARA Network for NORM which will interconnect groups of experts and provide experience for implementation of the ALARA principle in non-nuclear industries. This network shall maintain Codes of Practice for NORM industry managers and promote good radiation protection practice. It intends to improve and support appropriate radiation protection training, to identify problems to be solved and to propose solutions. Furthermore, proposals to the EC on harmonisation issues and areas of further work will be formulated. As a basis for the work to be done the actual situation regarding optimisation of radiological protection in the NORM industry of the European Community will be reviewed within a first step. As a consequence an internet communication system will be created that includes interactive websites, a document management system (DMS), discussion rooms and contact databases. With these facilities the EAN for NORM will be able to provide, via an internet portal, online support, recommendations and guidelines, decision support and scientific information concerning NORM related topics. In the paper, the concept and the milestones of the EAN for NORM are presented and the possibilities of external experts to contribute to its further development will be shown.

## **1 Introduction**

For an appropriate radiation protection not only the dose limits for workers and members of the public have to be observed, in addition the exposures should be kept as **low as reasonably achievable** (optimisation principle, acronym ALARA principle). This principle recommended by the ICRP is one of the (basic) principles of the European Basic Safety Standards, and the International Basic Safety Standards. Throughout the 1980s and early 1990s the ALARA principle was incorporated into the radiation protection practice, particularly in the nuclear research and industry and also in such practices using the radioactive, fissile or fertile properties of natural radionuclides. In the Directive 96/29 EURATOM [1] this principle was re-emphasised as one of the cornerstones of the radiological protection system. However, a generally applicable approach to optimise the radiation protection in the numerous cases of concern can not be given, since in the optimisation process all aspects of interest have to be taken into account, not only the health detriment of the exposure and the cost for protective measures but also economic and social factors and the circumstances of the individual case. Therefore, in 1996, the European Commission (EC) initiated the creation of a European ALARA Network (EAN) to specify European research on topics dealing with optimisation of all types of occupational radiation exposure, as well as to facilitate the dissemination of good ALARA practices within all sectors of the European nuclear industry and research. However the Directive 96/29 also requires that such work activities should be included in the institutional control which are not covered by the definition of practice (e.g. using the radioactivity of natural materials), but which involves the presence of natural radiation sources and lead to a significant increase in the exposure of workers and members of the public which cannot be disregarded from the radiation protection point of view. Such work activities are found in the non-nuclear industry, particularly in the industry processing raw materials containing increased concentrations of naturally occurring radioactive materials (NORM-industry).

Requirements for a proper radiation protection in case of practices are specified in numerous articles of the Directive 96/29. However, concerning radiation protection in the NORM-industry and other work activities only general requirements (e.g. implementation of appropriate corrective measures and the application of protection and monitoring measures specified in the Directive for practices or parts of them) are enclosed in the Directive. Therefore the optimisation is of central importance in order to get a proper radiation protection in the NORM-industry. In the last years numerous investigations found that there is still much to be done in the NORM-industry. However, up to now the NORM sector was not explicitly included in the existing EAN. Therefore, the European Commission decided to integrate the optimisation of radiation protection in the NORM-industry into the existing network. For this purpose the project entitled European ALARA Network for Naturally Occurring Material-NORM was launched. This project - acronym EAN<sub>NORM</sub>, will be executed in 2007 and 2008. EAN<sub>NORM</sub> will make possible the exchange of information and experience in applying the ALARA principle in non-nuclear industries and the direct distribution of recommendations and guidance. In this way, a significant step forward will be taken in providing a more coherent approach to the application of the optimisation principle in the NORM sector.

## **2 Conception of the European ALARA Network (EAN)**

### **2.1 Management of EAN**

EAN is coordinated by a Steering Group comprising one nominated institute-member per country. Currently, 19 countries are represented in this group. The Steering Group members may be any type of stakeholder concerned with radiation protection and the group decides on the work programme and the network activities.

The Centre d'études pour l'Evaluation de la Protection dans le domaine Nucléaire (CEPN, France) and the Health Protection Agency-Radiation Protection division (HPA-RP Division, UK) act as coordinator and assistant coordinator of the Steering Group.

### **2.2 Activities of EAN**

Twice a year the EAN produces a regular ALARA Newsletter to provide a link between all those persons and groups concerned with matters of radiation protection in Europe. In order to get widespread distribution of the information contained in these Newsletters they are open for publication and translation in other languages.

EAN has organised annual Workshops devoted to such fields of practical radiation protection for which significant improvements were desirable. As a result of each Workshop a set of recommendations is presented to the European Commission, to the national regulatory bodies and to other stakeholders in order to facilitate the practical implementation of the ALARA principle.

In 1997, the EAN opened a Website (<http://www.eu-alara.net>). This site provides access to electronic versions of the Newsletters and the Workshop papers, a collection of case studies concerning incidents ("Lessons Learned"), PowerPoint presentations, conclusions and recommendations. A forum, the archive and the links to co-operation partners and international organisations are further useful modules of the EAN-Website.

The latest type of product introduced by EAN is the sub-network. Several sub-networks have been set up on topics that needed more than a Workshop for reaching either in depth recommendations or developing some end products such as guidance, good practices book. In 2005, for example, the European Radioprotection Authorities Network (ERPAN) was set up in order to promote the communication between national regulatory authorities on regulations and control activities such as specific inspections and the transcription of EC Directives and recommendations into national regulations.



An other important suggestion from the EAN has now been installed: The Commission has concluded a contract to set up an ALARA NORM Network - acronym  $EAN_{NORM}$ . This project is implemented by the three companies IAF - HGN – RDS represented by the authors of this paper and steered by the European Commission. The running time of this contract amounts to two years (Jan 2007 to Dec 2008).

### **3 Conception of the ALARA NORM Network ( $EAN_{NORM}$ )**

#### **3.1 Purpose of installing $EAN_{NORM}$**

The objective of this project is the establishment of a network and a regular office for promoting rational and coherent management of radiation protection optimisation in non-nuclear industry.  $EAN_{NORM}$  is to be designed as a component of EAN in such a way to facilitate the direct exchange of information between national competent radiation protection bodies, the industry and the industry trade associations on regulatory initiatives and administrative procedures as well as on operational radiation protection measures. The  $EAN_{NORM}$  will form the basic structure for assimilation of experience gained in each step of the operation of NORM industry. Thus  $EAN_{NORM}$  will provide via an internet portal online support, recommendations and directives, decision support and scientific information concerning NORM related topics. Furthermore, the portal  $EAN_{NORM}$  should be a useful tool to interconnect groups of radiation protection experts working in the non-nuclear industry but also the health and safety managers, the radiation protection organisations, the research bodies, the regulatory bodies, and the trade union representatives-

#### **3.2 Collaborating Organisations of $EAN_{NORM}$**

One of the first tasks of this project is to identify a maximum of contact points willing to participate actively in the network. These are national radiation protection authorities, institutes or organisations which performed assessments and surveys of Member states competent authorities and established the respective studies for the European Commission, international and national associations or bodies representing specific industry sectors as well as national and international radiation protection associations. It is striven for the  $EAN_{NORM}$  that at least one contact point will be established in the national radiation protection authorities in each country, which are involved in the EAN. The CEPN and the IAEA should be included in the network structure, too.

#### **3.3 Methodology of $EAN_{NORM}$**

$EAN_{NORM}$  will maintain codes of practice for NORM industry managers and promote good radiation protection practice. It intends to improve and support appropriate radiation protection training, to identify problems to be solved and to propose solutions. Furthermore, proposals to the EC on harmonisation issues and areas of further work will be formulated. As a basis for the work to be done the actual situation regarding optimisation of radiological protection in the NORM industry of the European Community will be reviewed.

One of the first steps at the time of execution is the description of the scope of the network, the predefined aims of the project and the practical arrangement for the operation. Regulatory and operational emphasis have to be specified for it. Legal and administrative aspects of other European radiation protection regulations and the impact of other EU legislation on occupational health and safety have to be taken into account. The operational aspects are oriented towards initiatives to be taken aimed at optimising radiation doses and keeping them at optimised levels.

### **3.4 Activities of EAN<sub>NORM</sub>**

The contracting parties will arrange for setting up the network by interconnecting the identified participants (contacts points in the national authorities, NORM industries and industry trade organisations, international and national radiation protection organisations) with a direct online computer based information exchange system. This system will provide the formulation of guidance and recommendations on operational and practical measures aimed at giving effect to the reduction of doses to workers and the general public during industrial applications involving natural occurring radioactivity.

An internet communication system will be created that includes interactive websites, a document management system, discussion rooms and contact databases. With these facilities the EAN for NORM will be able to provide online support, recommendations and directives, decision support and scientific information concerning NORM related topics via an internet portal.

### **3.5 Next steps, external contributions, milestones**

A first Workshop on EAN<sub>NORM</sub> including all partners interested in ALARA NORM will be held in order to update and complete information on approaches, views and positions of the different groups. This meeting is planned in November 2007 in Dresden (Germany).

Up to the end of August a preliminary draft of content and functions of the ALARA NORM Network shall be prepared. One element of this network will be a collection of

- Reference levels used for decisions on protective measures and the classification of work places in the NORM industries,
- Scenarios, pathways and parameters used for dose calculations at workplaces,
- Methods for monitoring exposures of workers.
- Experience regarding minimising the exposure of workers in the NORM industries and at disposal of radioactive residues at landfills.

In order to put national experiences from European countries in an adequate way into this project, our work needs the support of partners from as many European countries as possible. All such partners interested in the issues described here are therefore asked to contact the authors in order to arrange the cooperation.

## **4 Summary**

This paper gives a first overview on the intentions and the next steps at the development of the European ALARA Network NORM (EAN<sub>NORM</sub>). We understand ourselves as a service provider in this project. The success of this network needs a cooperation of all interested parties (e.g. authorities, industry, associations, ...). The more information can be included in the EAN the merrier the network module serves the purpose of the EAN. Therefore, we invite all interested stakeholders to provide us their needs, their wishes, their ideas and to contribute their own opinions, their own experience, and their own point of views.

### **REFERENCE**

- [1] EC Directive 96/29 EURATOM of 13 May 1996 laying down basic safety standards for the protection of health of workers and the general public against the dangers arising from ionising radiation

# Assessment of TENORM sources in Slovenia\*

**Borut Smodiš, Urška Repinc, Ljudmila Benedik**

Department of Environmental Sciences  
Jožef Stefan Institute  
Jamova 39  
SI-1000 Ljubljana  
Slovenia

**Abstract.** Industries and activities handling NORM are identified and TENORM levels assessed in Slovenia. The identification is based on (1) survey of historical information available, (2) results published in scientific papers, (3) research reports made by research institutions within Slovenia and (4) original research aimed at obtaining more detailed picture of the areas investigated carried out. For this purpose, on-site gamma dose-rate measurements were performed, and TENORM/NORM materials sampled followed by high-resolution gamma spectrometry measurements for the determination of  $^{210}\text{Pb}$ ,  $^{238}\text{U}$ ,  $^{232}\text{Th}$ ,  $^{228}\text{Th}$  and  $^{226}\text{Ra}$ . Waste water and ground water samples were assayed for  $^{238}\text{U}$ ,  $^{226}\text{Ra}$  and  $^{210}\text{Pb}$  using RNAA, LSC and beta proportional counting. The inventory of the investigated sites is presented, giving the information on amounts of the deposited wastes, specific activities of the natural radionuclides and geographical distribution of the inventories in Slovenia. The TENORM sources identified and characterised pose negligible radiological risk to the general population.

## 1. Introduction

The earth's crust and mantle contain long-lived radionuclides such as  $^{40}\text{K}$  and members of U and Th decay chains, which constitute the major source of naturally occurring radioactive material (NORM) in the environment. Various anthropogenic activities may lead to the technological enhancement of NORM that is then named TENORM. The activities that can enhance NORM levels directly include mining, milling and processing of uranium ores and mineral sands, fertiliser manufacture and use, phosphate manufacture, burning of fossil fuels, metal refining, and general underground mining and open-cut mining activities. In addition, the use and disposal of waste materials (e.g. mine tailings, phosphogypsum and fly ash) associated with activities that produce NORM can pose significant radiological hazard. In this paper, an assessment of TENORM sources in Slovenia originating from past and present activities is given, and comprehensive inventory is derived from the data collected.

## 2. Identification of TENORM sources in Slovenia

In the past, there were two main nation-wide radioactivity surveys carried out: Rn mapping [1] and mapping of natural radioactivity in Slovenia [2]. The main mines identified as sources of TENORM are (Fig. 1): uranium mine at Žirovski vrh, mercury mine in Idrija, coal mine in Kočevje and brown coal mine in Senovo [3-6]. The biggest coal-fired thermal power plants are located in the cities of Ljubljana, Trbovlje and Šoštanj. The ashes resulting from the coal burning processes are deposited onto wet or dry dumping places close to the power plants [7]. The main industries identified as the sources of TENORM are: phosphate processing plant at Hrastnik, titanium dioxide production plant in Celje and aluminium refining plant in Kidričevo [8, 9]. Previous studies have identified increased levels of natural radionuclides in surface waters and ground waters due to the leaching of radionuclides from thermal power-plant ash deposits in Velenje and shafts in Hrastnik [7, 9].

---

\* Work performed with the support of Slovenian Nuclear Safety Administration (Contract No. 397-14/2004/1/0300) and Slovenian Research Agency (Contracts Nos. P1-0143 and P2-0075).

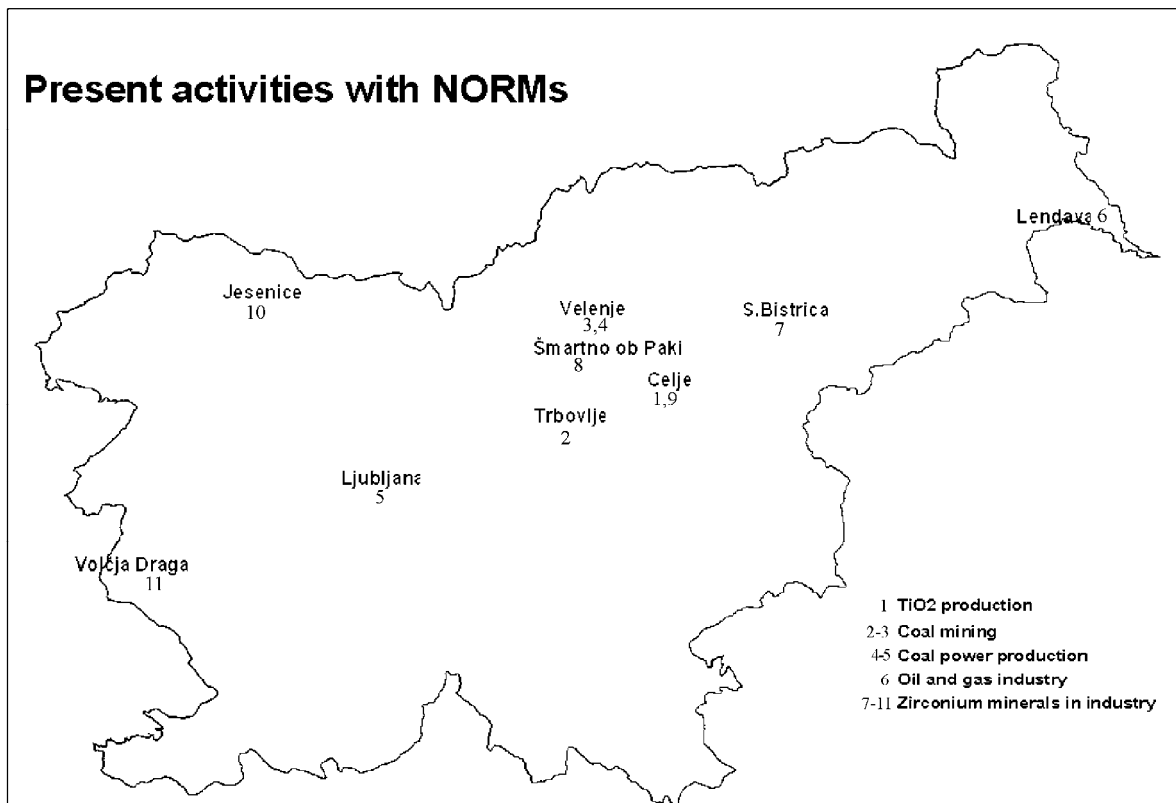
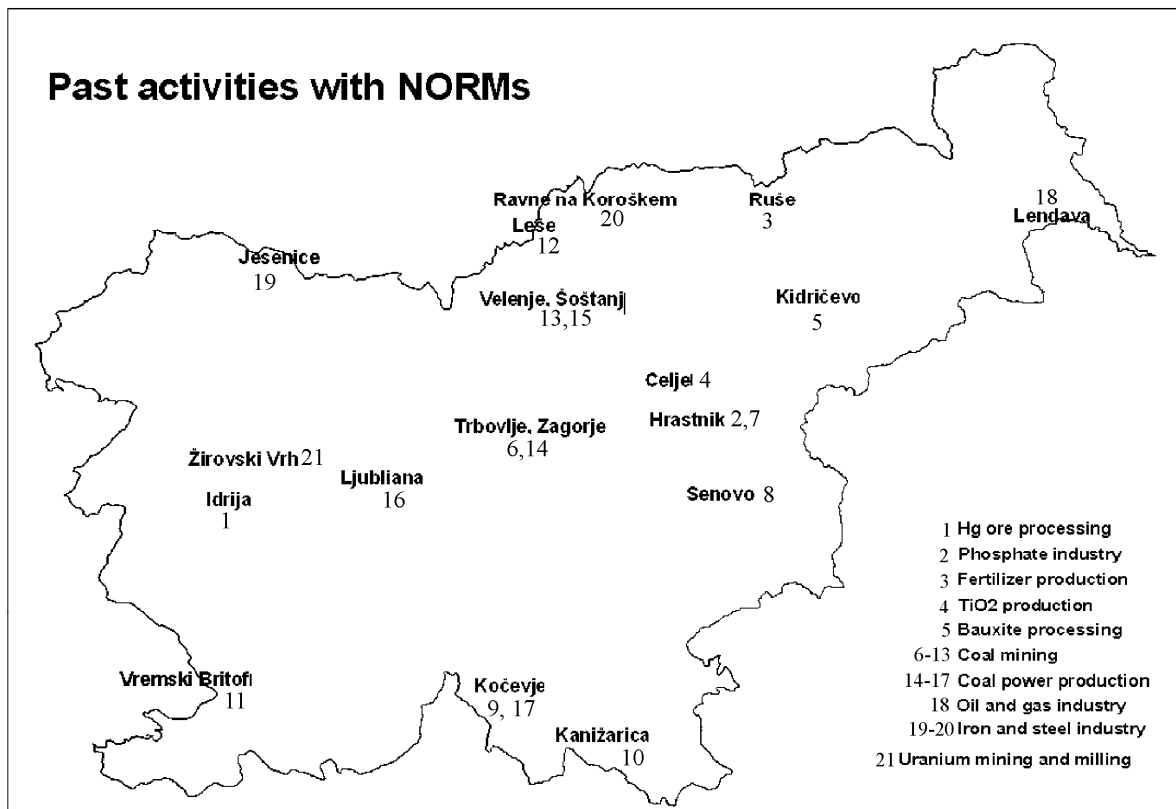

FIG.1. Past and present activities in Slovenia involving NORM

Within the present study, the following TENORM sources were identified and investigated in more detail: iron and steel refining and production plants at Jesenice and Ravne, coal mines at Vremški Britof and Kanižarica (both already closed), and natural gas and oil extraction plant in Lendava.

Within the selected sites with significantly increased levels of natural radioactivity, the influence of TENORM on the ground waters and surface waters was further investigated.

### 3. Experimental

Soils and deposited materials from the selected sites were collected according to the judgemental sampling approach. The samples collected were representative for specific sampling sites and assayed for radionuclides content based on the worst-case scenario. The samples were dried at 60 °C, milled, pulverised (if needed), sieved through a 2 mm sieve, packed into a 100 cm<sup>3</sup> cylindrical vessels and sealed for subsequent gamma spectrometric measurement. External gamma-ray dose rate was measured by: (1) portable survey meter Eberline ASP-1 equipped with a NaI(Tl) 1x1" scintillation detector, (2) multi-function survey meter ADM-300SI equipped with Geiger-Mueller probes and NaI(Tl) 3x3" scintillation detector, and (3) portable FieldSPEC spectrometer equipped with both NaI(Tl) 1x2" and Geiger-Mueller detectors. The measurements were carried out at 1 m above the ground. Gamma spectrometric measurements were carried out on an HP Ge detector having 25 % relative efficiency and resolution of 1.9 keV (FWHM) at 1.33 MeV. The detector was calibrated using certified reference materials and self-absorption corrections of the samples measured were performed using the Cutshall's method [10]. The following radionuclides were assayed: <sup>210</sup>Pb, <sup>238</sup>U, <sup>226</sup>Ra, <sup>228</sup>Ra, <sup>228</sup>Th, <sup>40</sup>K and <sup>137</sup>Cs.

Wastewater (outflows of waste deposit sites) and ground water samples were collected using single sampling approach. Samples were filtered through 0.45 µm membrane filter (Millipore HAWP) and acidified (1mL of conc. HNO<sub>3</sub>/1L of sample) before radiochemical analysis was performed. The natural radionuclides <sup>238</sup>U, <sup>226</sup>Ra and <sup>210</sup>Pb were determined using: (1) radiochemical neutron activation analysis (RNAA) for <sup>238</sup>U, (2) liquid scintillation counting with α/β discrimination for <sup>226</sup>Ra and (3) beta counting of <sup>210</sup>Bi for <sup>210</sup>Pb, using the previously published procedures [11-13].

### 4. Results and discussion

In the Idrija region, gamma spectrometric measurements of smelting residues and other waste products that were used as construction materials were carried out. Radionuclides from both the U-Ra and Th decay chains were in equilibrium and the specific activities found were from 40 to 1400 Bq kg<sup>-1</sup> and from 10 to 75 Bq kg<sup>-1</sup>, respectively. Specific activity of <sup>40</sup>K ranged from 120 to 450 Bq kg<sup>-1</sup>. Average specific activity in Slovenian soil is 41 Bq kg<sup>-1</sup> for <sup>238</sup>U (ranging from 1.4 to 210), 35 Bq kg<sup>-1</sup> for <sup>232</sup>Th (ranging from 1.3 to 90) and 385 Bq kg<sup>-1</sup> for <sup>40</sup>K (from 16 to 1450).

In the Kočevje area, the values for soil samples ranged from 83 to 2500 Bq kg<sup>-1</sup> for U-Ra decay chain. The three measured radionuclides (<sup>238</sup>U, <sup>226</sup>Ra, <sup>210</sup>Pb) were not in equilibrium, indicating that the soils contain ashes resulting from the coal burning processes. The specific activities for the two Th decay chain members (<sup>232</sup>Th and <sup>228</sup>Th) ranged from 33 to 66 Bq kg<sup>-1</sup> and for <sup>40</sup>K from 158 to 478 Bq kg<sup>-1</sup>. In the city of Kočevje the highest levels of airborne radon were already reported before [5].

At the Jesenice area, a landfill consisting of steel industry waste products was surveyed for external gamma dose rate. The average dose rate was 127 ± 15 µSv h<sup>-1</sup> with several hot spots indicating a non-uniform distribution of material. Detailed gamma spectrometric analysis yielded the values from < 5 to 634 Bq kg<sup>-1</sup> for the members of U-Ra decay chain, from < 10 to 53 Bq kg<sup>-1</sup> for the members of Th decay chain and from 137 to 427 Bq kg<sup>-1</sup> for <sup>40</sup>K.

Similar investigation was carried out at the Ravne area, where the average gamma dose rate found was 0.17 ± 0.06 µSv h<sup>-1</sup>. Gamma spectrometric analysis yielded the values from < 10 to 48 Bq kg<sup>-1</sup> for the members of U-Ra decay chain, from 10 to 12 Bq kg<sup>-1</sup> for the members of Th decay chain and from 25 to 51 Bq kg<sup>-1</sup> for <sup>40</sup>K.

In the vicinity of Vremški Britof there was a black coal mine operating until the year 1956. The measured external gamma dose rates within area affected by the former mine ranged from 0.15 to 0.40

$\mu\text{Sv h}^{-1}$ . Specific activities for the members of U chain ranged from 28 to 6138 Bq  $\text{kg}^{-1}$ , for the members of Th chain from < 10 to 22 Bq  $\text{kg}^{-1}$ , and for  $^{40}\text{K}$  from 11 to 153 Bq  $\text{kg}^{-1}$ .

TABLE I. INVENTORY OF TENORM IN SLOVENIA (AMOUNTS, SPECIFIC ACTIVITIES)

NORM	Mass of the deposited material	Specific activity (Bq/kg)	Literature data [14] ( $^{226}\text{Ra}$ , Bq/kg)
<b>Past activities</b>			
Smelting residue (Hg)	1,000,000 t	$^{226}\text{Ra}$ : 400 – 1,200	No data
Phosphate gypsum (TKI Hrastnik)	600,000 t (Mostly released into water bodies)	$^{226}\text{Ra}$ : 400	15 – 1,700
Red mud (Kidričevo)	6,500,000 t	$^{226}\text{Ra}$ : 200	10 – 9,000
	1,500,000 t (ash)	$^{228}\text{Ra}$ : 400	
Hydrometallurgical waste (HMJ);	600,000 t	$^{226}\text{Ra}$ : 8,600	10,000 – 20,000
Mill tailings	3,500,000 t	$^{238}\text{U}$ , $^{226}\text{Ra}$ : 730	
Coal ash (Kanižarica, Kočevje)	No data	$^{226}\text{Ra}$ < 2,700	< 2,000
Pipe tailings	No data	$^{226}\text{Ra}$ : 170	< 15,000
Formation water (Nafta Lendava)		$^{226}\text{Ra}$ : 0,82 Bq/L	
<b>Present activities</b>			
Coal fly ash (3 TPPs)	1,000,000 t/year (Sum ~ 30 mil. t)	(TEŠ) $^{226}\text{Ra}$ : 350 (TET) $^{226}\text{Ra}$ : 180 (TE-TOL) $^{226}\text{Ra}$ : 400	<2,000
Gypsum (Celje)	600,000 t	$^{228}\text{Th}$ : 66-155	No data
Slag			64 – 380 (slag)
- Jesenice	12,000 t/year (Sum ~ 317,000 t)	$^{226}\text{Ra}$ : 100 – 600	15,000 – 30,000
- Ravne na Koroškem	20,000 t/year (Sum ~1,5 mil. t)	$^{238}\text{U}$ : < 30	(filter dust)

Within the area of the former coal mine at Kanižarica the following specific activities ranges were determined: U-Ra decay chain from 111 to 749 Bq  $\text{kg}^{-1}$ , Th chain from 12 to 437 Bq  $\text{kg}^{-1}$ , and  $^{40}\text{K}$  from 61 to 562 Bq  $\text{kg}^{-1}$ .

The natural gas and oil extraction plant Nafta Lendava was also identified as potential source of TENORM. In particular silts, various linings deposited onto drilling and production tubes, as well as the so-called production water were identified as sources. The following specific activities were determined: U-Ra decay chain from < 10 to 270 Bq  $\text{kg}^{-1}$ , Th decay chain from 16 to 620 Bq  $\text{kg}^{-1}$  and  $^{40}\text{K}$  from 54 to 212 Bq  $\text{kg}^{-1}$ .

In the final step following the radiological measurements, inventories of TENORM originating from different activities were carried out, comprising identification and quantification of raw materials entering technological processes, wastes produced, specific activities of the key NORM, and size of the particular dumping grounds concerned. The results are summarised in Table I, where the values obtained are compared to the literature data [14].

It was found that there is a continuous, though small, production of TENORM in Slovenia as result of industrial activities. However, most of wastes are deposited on protected areas that are generally inaccessible by the general public. Consequently, the potential radiation exposure is presumably low. Preliminary calculations made revealed that the radiation exposure for people spending 20 % time outdoors would result in annual effective doses lower than total annual effective dose received by Slovenian population in all cases [15].

More than 90 % of TENORM in Slovenia is produced due to coal burning in thermal power plants and steel industry. This TENORM does not contain significant amounts of natural radionuclides and is deposited at protected areas. Specific activities of critical radionuclides in Slovenian TENORM are generally lower in comparison with similar materials in the world. Exceptions are coal ashes and mining oddments from the areas with naturally elevated radioactivity levels (Kanižarica, Kočevje, Vremški Britof, Idrija).

In the year 1990, increased levels of natural radioactive isotopes were reported in the Sava river, the longest stream in Slovenia. ). The increased levels were attributed to coal mines waste waters, thermal power-plant in Trbovlje, coal ash deposits, as well as the phosphate industry in Hrastnik [8]. Measurements of ground waters and surface waters in the vicinity of the identified locations, carried out within the present study, revealed the values in the range from 1.6 to 4,000 Bq m<sup>-3</sup> for <sup>238</sup>U, from 0.5 to 37 Bq m<sup>-3</sup> for <sup>226</sup>Ra and from <1 to 233 Bq m<sup>-3</sup> for <sup>210</sup>Pb. Increased levels of <sup>238</sup>U were found only in groundwater samples from the uranium waste depository sites at Žirovski vrh, while increased levels of <sup>210</sup>Pb were found in the groundwater samples in the vicinity of the old depository of mercury smelting residues in Idrija. The results are summarised in Table II. The values indicate that the TENORM generally does not increase the levels of natural radioactivity in ground waters. The values obtained are comparable to the values found in drinking water in Slovenia, ranging from 1.2 to 7.1 Bq m<sup>-3</sup> for <sup>238</sup>U, from 1 to 60 Bq m<sup>-3</sup> for <sup>226</sup>Ra and from 2 to 20 Bq m<sup>-3</sup> for <sup>210</sup>Pb [9].

## 5. Conclusions

Retrospective surveys and present measurement results confirmed that the deposited materials at the investigated areas in Slovenia contain elevated levels of natural radionuclides compared with the average content found in soil. The reason is elevated uranium content in ores and coal, which is further enriched in waste products such as smelting residues and ashes produced during technological processes.

TABLE II. SPECIFIC ACTIVITIES OF RADIONUCLIDES IN GROUND AND WASTEWATERS IN THE VICINITY OF TENORM DEPOSIT SITES (Bq/m<sup>3</sup>, SUMMARY)

Sampling site	<sup>238</sup> U	<sup>226</sup> Ra	<sup>210</sup> Pb
Idrija (mercury mine)	5.7 – 16	3.1 – 37	10 – 233
Velenje (TEŠ)	1.6 – 2.7	1.3 – 3.6	< 1 – 4.1
Celje (TiO <sub>2</sub> production plant)	< 0.1 – 4.9	2.9 – 10.7	< 1 – 2
Kidričevo (aluminium refining plant)	12.6 – 17.8	0.5 – 19	1.2 – 186
Žirovski vrh (uranium mine)	20 – 4,000	3.6 – 10	< 1 – 3
UV2 limit [16]	3,000	480	190

The quantities of these materials currently produced are well evidenced; more problematic are historic burdens that are more difficult to identify and quantify. The most critical are oddments of mercury mining in the Idrija area and coal ash in the Kočevje area, which were in the past often deposited in the hearts of the nearby cities.

The radioactivity in the materials investigated does not exceed exemption levels imposed by the Slovenian legislation in most of the cases. Based on generic estimates of the identified activities and preliminary dose calculations we may conclude that the emerged TENORM poses very low risk to population due to the resulting ionising radiation.

## REFERENCES

- [1] VAUPOTIČ, J., et al., Systematic indoor radon and gamma measurements in kindergartens and play schools in Slovenia, *Health phys.* **5** (1994) 550.
- [2] ANDJELOV, M., Results of radiometric and geochemical measurements for the map of natural radioactivity in Slovenia (in Slovene), *Geologija* **36** (1994) 223.
- [3] BENEDIK, L., et al., Measurements of the radioactivity in the Žirovski Vrh uranium mine environment and assessment of its environmental impacts – results for 2003 (in Slovene), IJS DP-8935 (2004).
- [4] KRIŽMAN, M., STEGNAR P., Mercury ore processing - a new source of technologically enhanced natural radioactivity, *Environ. Int.* **22** (1996), 251.
- [5] KRIŽMAN, M., et al., “Environmental radioactivity around the former coal mine in Kočevje (Slovenija)”, (Proc. Symp. Radiation Protection in Neighbouring Countries in Central Europe –1995) IRPA (1995).
- [6] JERAN, Z., et al., Expert opinion on the urbanization options at the Senovo mine area: radioactivity measurements on the mine tailings (in Slovene), IJS DP-8074 (1999).
- [7] BRAJNIK, D., et al., Sources of technologically enhanced natural radioactivity and their impact in Slovenia (Yugoslavia), *Rad. Prot. Dosim.* **24** (1988) 551.
- [8] KOBAL, I., et al., Radionuclides in influent from coal mines, a coal fired power plant, and a phosphate processing plant in Zasavje, Slovenia, *Health Phys.* **58** (1990) 81.
- [9] BENEDIK, L. et al., The influence of technologically enhanced radioactive materials on radioactivity of underground and surface waters in Slovenia (in Slovene), IJS DP-8836 (2004).
- [10] CUTSHALL, N. et al., Direct analysis of  $^{210}\text{Pb}$  in sediment samples: Self-absorption corrections, *Nucl. Instr. and Methods* **206** (1983), 309.
- [11] BYRNE, A. R., BENEDIK, L., Determination of uranium at trace levels by radiochemical neutron-activation analysis employing radioisotopic yield evaluation, *Talanta* **35** (1988) 161.
- [12] REPINC, U., BENEDIK, L., Development of a method for determination of  $^{226}\text{Ra}$  by liquid scintillation counting, *J. Radioanal. Nucl. Chem.*, **254** (2002) 181.
- [13] BENEDIK, L, VREČEK, P., Determination of  $^{210}\text{Pb}$  and  $^{210}\text{Po}$  in environmental samples, *Acta Chim. Slov.* **48** (2001) 199.
- [14] INTERNATIONAL ATOMIC ENERGY AGENCY, Extent of environmental contamination by naturally occurring radioactive material (NORM) and technological options for mitigation, Technical Reports Series No. 419, IAEA, Vienna (2003).
- [15] KNEZ, H., Slovenian National Chemicals Bureau, personal communication, 2006.
- [16] REPUBLIC OF SLOVENIA, Regulation UV2 on doze limits, radioactive contamination and intervention levels, Official Gazette of the Republic of Slovenia 49/2004.



## **REDRADNA: The Spanish network on natural radiation**

Luis Quindós, Carlos Sainz, Ismael Fuente, Luis Quindos-Lopez , Jose Arteche  
Universidad de Cantabria, Facultad de Medicina, C/Cardenal Herrera Oria s/n 39011,  
Santander, Cantabria, España

**Abstract.** REDRADNA is a nationwide project which involves the participation of fifteen Spanish institutions including universities, research centres and regulatory organisms. The creation of this network pursuit the main objective of promoting the transfer of knowledge about several aspects of natural radiation field between the participants as well as the stimulation of collaborative research actions. Besides, the development of the REDRADNA network will allow the creation of a collective data base with information about research projects, main results, instrumentation and methodologies. On the other hand a better access to the National and European Research Programs is expected from this coordinated union of human and structural resources. Finally, an important issue within the network is the public diffusion of results and information of interest for the general public concerning natural radiation.

There is a wide consensus within radiation physics scientists about the main contribution of natural sources of radiation to the total ionising radiation dose received by humans all around the world. As an additional contribution to this fact, economical globalization has enhanced the interchange and use of prime materials and products with high levels of naturally radioactive material (NORM) which are employed in different productive activities. At different production phases, this kind of materials can significantly increase workers and public exposure to ionising radiation. 96/29/EURATOM European Council Directive have been implemented into Spanish Legislation throughout the Title VII, on which natural sources of radiation play an important role with regard to radiological protection actions. In order to help Member States in the application of this Directive, the European Commission have published several documents referred to: general aspects of the implementation into national regulations (Radiation Protection 88), establishment of reference levels in NORM-related working places, and exemption and classification of natural sources of radiation (Radiation Protection 122, part II). However, still there is not a complete scientific consensus about these publications and some aspects would need for further research.

In Spain, this situation lead to the necessity of an Expert Working Group for giving response to the incoming scientific and practical challenges derived from the inclusion of the natural sources of radiation in the radiological protection system.

With this motivation, the REDRADNA (Spanish Network on Natural Radiation) is integrated by several Spanish Research Groups from Universities and Research Centres following these main objectives:

- 1.- Introduction of research groups in the field of natural radioactivity within the Network.
- 2.- Identification and integration of final users as well as their demands and necessities.
- 3.- Creation of a national Research Data Base in this field which can include different aspects related with Research Projects, Results, Methodologies and Instrumentation
- 4.- To reach a “critical mass” of researchers in the field of natural radioactivity in order to improve the possibilities of access to the National Research Plan (I+D+I) as well to increase the possibilities to access to the European Research Programs (7<sup>th</sup> Framework Programme for Community Research)

5.- To share educative and research experiences.

6.- Diffusion of information and knowledge about natural radioactivity.

The development and coordination of the Network activities will be held at the web page [www.redradna.com](http://www.redradna.com) which will be a meeting point for the communication between partners as well as a portal on natural radiation for the general public.

# **Regulatory Aspects on NORM/TENORM Activities in Malaysia**

**I.L Teng**

Atomic Energy Licensing Board (AELB),  
Batu 24, Jalan Dengkil,  
43800 Selangor D.E.,  
Malaysia

**Abstract.** Naturally Occurring Radioactive Material (NORM) processing industries in Malaysia include oil and gas production and mineral processing plants. These industries are controlled by the Atomic Energy Licensing Board of Malaysia (AELB) through the enforcement of Atomic Energy Licensing Act 1984 (Act 304). However, more regulations are necessary for the safe handling of NORM. NORM processing generates various types of NORM/TENORM residues that require proper management and disposal. As for low-level NORM residues from oil and gas production and mineral processing plants, landfill disposal is commonly used. However, wastes generated from decommissioning and decontamination of mineral processing plant is disposed in engineered cell at the disposal site. This paper outlines the regulatory aspects on NORM/TENORM activities in Malaysia.

## **1. Introduction**

Naturally Occurring Radioactive Material (NORM) has received much attention in Malaysia. This is due to the presence of several industries related to NORM. Handling of NORM falls under the jurisdiction of the Atomic Energy Licensing Board of Malaysia (AELB) through the enforcement of the Atomic Energy Licensing Act 1984 (Act 304). In Malaysia, the most common activity related to TENORM are industrial activities related to the mining and the subsequent processing, resulting in the increase of the naturally occurring radioactive materials. The issues related to NORM and TENORM attracted a lot of public interest and the mass media in the late 1970s. Since Malaysia was a major tin producer and currently active in oil and gas industry, there is growing concern related to the TENORM wastes issues.

## **2. TENORM industries in Malaysia**

In Malaysia, the wastes associated with TENORM are generated mostly in the tin mining and smelting, processing of minerals, oil and gas industry and decommissioning of mineral processing plant activities.

### ***2.1. Mineral processing and mining industry***

Certain minerals of tin-mining byproduct, such as amang (heavy mineral sand), monazite, ilmenite, zircon or xenotime contain natural radioactive elements such as uranium, thorium and radium co-exist with the tin ore or cassiterite in the ground. Down-stream processing of ilmenite, zircon and monazite produces end products such as titanium oxide (as pigment in paint, paper plastics, cosmetics, etc), zirconium (used in ceramics, refractory, catalysts, or fuel cladding and structural materials in reactors) and rare earth elements (electronics, illumination, superconductors, ceramics, etc).

In the process of the mineral extraction process, these radioactive elements become more concentrated and need proper management. This type of waste derived from this tin mining and mineral processing industry has a low specific activity but long-lived alpha emitters.



Mineral sand



Mineral processing

## ***2.2. Oil and gas industry***

Another important source of TENORM is from the oil and gas industry – in this case mostly from the oil sludge and scales from oil well production and oil refineries. The most dominant radionuclide in oil sludge are Ra-226 and Ra-226, where as Uranium and Thorium contribution is very small compared to other minerals such as ilmenite, zircon, etc. The total specific activity in oil sludge/scale ranged from 200 – 13, 000 Bq/kg.

In the above processes, TENORM may remain in solution, precipitate, sludge, scales particulates or residues within the production process itself or the waste streams. The waste associated with TENORM account for a significant number of the radioactive waste management problem in Malaysia. TENORM wastes characteristics are the presence of long-lived alpha radionuclides and present in very large volume compare to other types of radioactive waste.

## ***2.3. Decommissioning and decontamination (D&D) wastes***

The rare earth production industry ceased its operation in the early 1990's due to high competition from other Asia's country and the difficulty in obtaining consistent and sufficient supply of monazite (raw materials, byproduct of tin mining activities) as a result of the slowing down in tin mining industry in Malaysia. The rare earth company is currently conducting D&D process of the monazite cracking plant. The wastes generated from this process are contaminated equipments and contaminated soils. The estimated volume of the contaminated materials is 50,000 m<sup>3</sup>.

## **3. Regulatory aspects**

The main act used in Malaysia to deal with radioactive materials including NORM is the Act 304 (AELA, 1984a). AELB continually develops regulations and guidelines in order to ensure safe handling of NORM.

Under the Act 304, the management or disposal of radioactive waste is specifically dealt with under Sections 26-31 of the Atomic Energy Licensing Act 1984. These sections empower the Atomic Energy Licensing Board (AELB) to ensure users (licensees) to obtain appropriate license prior to dealing (accumulate, transport or dispose) with radioactive waste and to take appropriate actions to rectify situation which deemed unsafe. These provisions, however, do not provide details on the measures should be taken by the user.

The Radiation Protection (Basic Safety Standard) Regulations, and Radiation Protection (Licensing) Regulations cover all aspects of 'dealing' with radioactive and radiation sources including NORM. Dealing means any activity involving manufacturing, trading, producing, processing, purchasing, owning, using, transporting, transferring, handling, selling, storing, importing or exporting radioactive material. Dealing with NORM requires a license, either license Class A (milling of radioactive materials) or Class D (transport of radioactive materials) or Class E (Export or import of radioactive materials) or Class G (disposal, storage, and decommissioning of milling installation, waste treatment facility) or Class H (miscellaneous, e.g. services for decontamination and decommissioning work, treatment of sludge and scales, etc). Together with the license, AELB usually issues license conditions to be fulfilled by the licensees.

The AELB will consider the issuance of the license after scrutinizing applicant's capability. In the case of TENORM, a person intending to dispose of the waste should apply for a license under Class G, which is:

- a) to dispose of radioactive minerals (NORM/ TYENORM wastes);
- b) to store radioactive minerals (NORM/TENORM), or their wastes prior to their disposal;  
or
- c) to decommission and decontamination a milling installation, waste treatment facility, laboratory and other related facilities.

The current practice prior to the approval of a landfill disposal activity is that the licensee should submit a Radiological Impact Assessment (RIA) to the AELB. It is common to undertake the task using a computer code, RESRAD, developed by the Argonne National Laboratory US. The RIA should as much as possible use site specific parameter and demonstrate that the dose to the members of the public do not exceed the limit stipulated in the Act or Regulations. In practice, AELB is using a constraint limit of 0.3 mSv/y. In some cases, radiological monitoring maybe required to be carried out after the disposal.

#### **4. Management of NORM/TENORM wastes**

##### ***4.1. Storage and treatment***

Storage and treatment of NORM wastes require permission from the authority. As the volume of wastes is tremendous, iron oxide and red gypsum wastes generated from TiO<sub>2</sub> production are allowed to be dumped temporarily at companies' premises. Red gypsum and Iron oxide have the potential to be used in consumer products, e.g. gypsum in partition wall and iron oxide as red bricks for pavement.

As for the sludge and scales from oil and gas industry, apart from storing in metal drums some companies apply sludge farming method to treat the wastes in order to remove the hydrocarbon content through bio-degradation process. This method is simple and cheap but the process is very

slow and it requires a large area of land. Incineration, as applied by Hazardous Waste Treatment and Disposal Centre is another potential method to remove hydrocarbon content of sludge. It is a common practice to return the volume-reduced secondary residues from the treatment process back to the primary residues generator. This clearly shows that there are still problems to solve after treatment.



Drum Transportation



Compacted waste



Waste Processing Area



Low-Level Aqueous Effluent Treatment Plant

#### ***4.2. Landfill disposal***

The disposal of NORM residue is still a problem. For low-level activity residues, landfill disposal is one of the potential options. The residues that can be disposed of by landfill include primary residues such as tin slag, iron oxide and red gypsum and the secondary residues from treatment such as incineration ash, matured sludge from sludge farming and sediment residues from chemical extraction.

In the past, tin slag was considered an ordinary waste and was used as landfill material in a northern state, where the smelting had been carried out. Recently, tin slag has been realized to contain tantalum, niobium and tungsten and can be sold for extraction of the precious metals. Resale of the residues helps in reducing the volume of the waste. However, the price of the tin



slag varies depending on the market demand. Newspapers reported that a local authority had offered a tender to dig out tin slag from a stadium prior to its renovation. As for slag dumped in other area, there was no effort to recover or to intervene. Prior to closing down of one of the tin smelting plant, tin slag was approved to be used for reclaiming a piece of swampy land which was planned to build a warehouse.



Iron Oxide



Oil Sludge Farm

#### ***4.3 Disposal facility (engineered cell)***

The repository for disposal of NORMs-bearing waste is a trench or rectangular cell type. The Cell is capable to accommodate 65,000 m<sup>3</sup> wastes, although the estimated volume of waste is 55,000 m<sup>3</sup>.

Contaminated soil and plant components from the rare earth plant D&D were transported to an engineered cell at the approved disposal site. The future plan is to decontaminate and decommission the thorium hydroxide storage facility and dispose the waste in another engineered cell at the disposal site. The Engineered Cell has several layers including geochemical barrier, geochemical intruder barrier, concrete capping and soil cover.

The cover thickness is 1.2 m. This cover includes an erosion barrier, a layer that promote surface water drainage, a surface water infiltration barrier, and an intruder barrier. The planned institutional control will be for at least 300 years. During this period, the owner will carry maintenance work (to mend fence, warning signs, markers), ensure no serious damage due to erosion, human intrusion for cultivation or animal encroachment which can damage the integrity of the repository.

Samples of vegetation, fish, soils and water will be collected and analyzed to determine radionuclide migration as a result of any leakage. All reports on the radiation monitoring will be submitted to the regulatory body (AELB) at a regular interval as agreed by both parties.

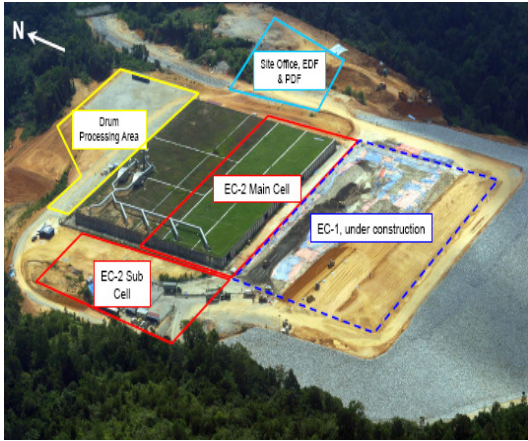

Top view for EC 1 and LTSF



Interim Capping For EC 1



## State of the art of the problems of NORM in Ukraine

B. Zlobenko

Institute of Environmental Geochemistry NAS and MES of Ukraine  
Kyiv, Ukraine

**Abstract.** In the paper an overview of the problems of naturally occurring radioactive material (NORM), as well as of the related regulatory approaches is presented. Natural isotope of uranium and thorium series, make a larger contribution in irradiation of the population, than artificial radionuclides. It is caused by the following reasons:

- Geological conditions of the country;
- Intensive development of mining and a processing industry;
- High population density in industrial regions of the country.

The central regions of Ukraine (30-35% of all Ukrainian territory) are situated on the crystalline massif with high concentrations of natural radionuclides. Due to this fact, the main dose-forming factor (natural radioactivity) may be considerable (78%). This problem became extremely sharp in Ukraine after the accident at the Chernobyl NPP.

### 1. Introduction

In recent years there has been an increasing attention to naturally occurring radioactive material (NORM) in various non-nuclear industry processes. Such radioactive materials belong to the decay series of long lived nuclides thorium-232, uranium-235 and uranium-238. The concentrations of naturally occurring radioactive substances in the earth crust vary widely. The basic sources of natural radioactivity are concentrated on the territory of Ukraine within the limits of the Ukrainian Shield, Donbass and Carpathian mountains. The central regions of Ukraine (30-35 % of Ukrainian territory) are situated on the crystalline massif with high concentrations of natural radionuclides. High level of radon flux is detected on 20 % of Ukrainian territory. The numerous geochemical anomalies (Fig. 1) with concentration: radon -  $3,7 \cdot 10^2 \div 5,6 \cdot 10^3$  Bq/l, uranium -  $5 \cdot 10^{-5} \div 1 \cdot 10^{-4}$  g/l and radium  $1 \div 5 \cdot 10^{-11}$  g/l are found in Zhytomyr, Donetsk, Zaporizhzhia, Vinnytsia, Kirovograd and Cherkasy regions. The NORM pollution in Pryazovie Monocytting Sands (Donetsk region) is one of the most damaging and dangerous types of contamination.

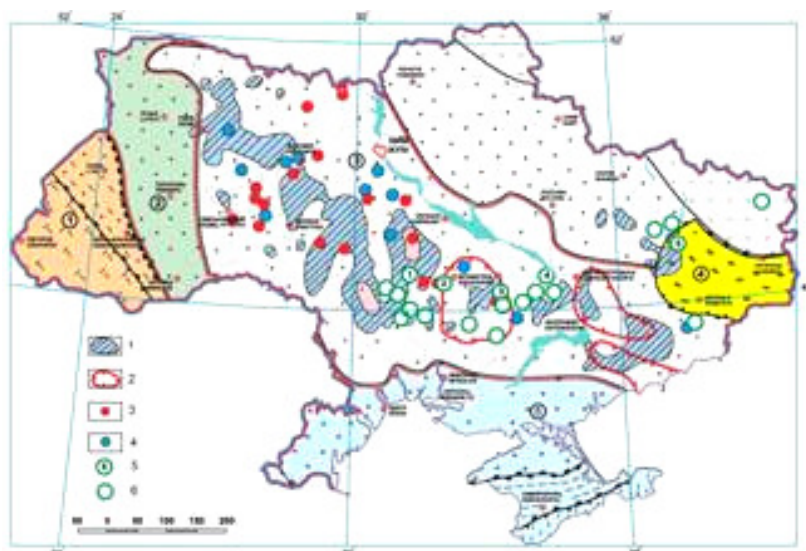

FIG. 1. Natural radioactivity of Ukrainian territory [1], where

1. The areas with abnormal concentration of radon
2. The areas with abnormal concentration of uranium
3. Anomalies of thorium in crystal breeds
4. Deposits of radon waters
5. Deposits of uranium
6. Other deposits with abnormal concentration of NORM

TABLE 1. DISTRIBUTION OF RADIOACTIVITY IN PRYAZOVIE MONACYTING SANDS

The characteristic of samples	Specific activity of Bq/kg	
	Ra-226	Th-232
«Black sand» from spots	136,0 ± 20,0	1332,5 ± 129,5
«Black sand» (concentrate) from spots	249,5 ± 8,3	2398,4 ± 54,9

As can be seen from Table 1, the basic NORM in coastal alluvial deposit of “black sand” is thorium (~70 %). Increase in a specific radioactivity of “black sand” samples from spots is determined by presence of thorium and radium isotopes [2].

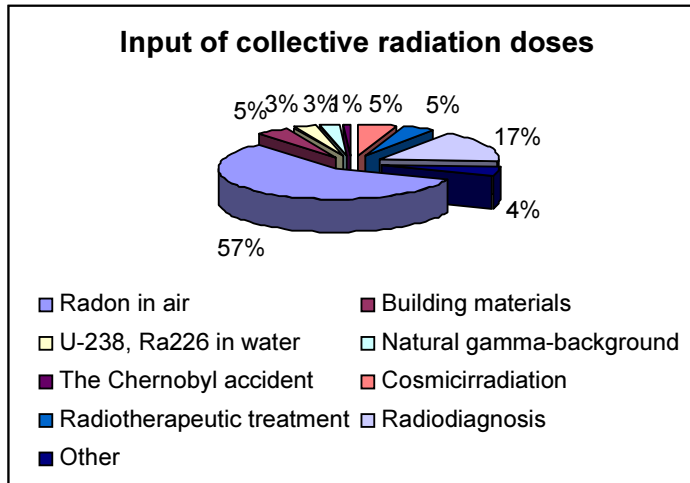

FIG. 2. The assessment of collective radiation doses of Ukrainian population

This problem became extremely sharp in Ukraine after the accident at the Chernobyl NPP. Natural isotope of uranium and thorium series makes a larger contribution in irradiation of the population than artificial radionuclides (Fig. 2). It is determined by the following:

- Geological conditions of the country;
- Intensive development of mining and a processing industry;
- High population density in industrial regions of the country (Fig. 3).

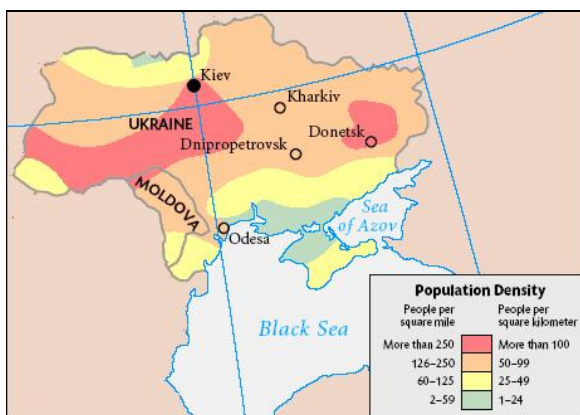

FIG. 3. Population density in Ukraine .

Numerous surveys have been conducted by some institutions to characterize the occurrence and distribution of NORM. Unfortunately, most of the data from these surveys are not readily available. The lack of access to these data coupled with the fact that the available data have not been included into the national database makes it difficult to characterize NORM wastes, particularly with respect to

calculating average radioactivity levels. Thus, it is not possible to calculate a statistically representative average source term concentration.

The mining and processing of minerals from deposits containing naturally occurring radioactive materials have always resulted in increased concentrations of NORM in products or process wastes. Every year the economy of Ukraine consumes near 1.5 billion tons of natural materials. The industrial waste originated primarily from fuel production enterprises and energy plants ( $\approx 11.7$  million tons of ashes and slag), and coal mining and coal treatment enterprises ( $\approx 100$  million tons). In Ukraine the oil and gas industries are discharging enormous amounts of low level natural radioactivity into environment. Significant amounts of waste also come from other mining industries. The inventory of radioactive waste generated by industrial processing of NORM is not available in Ukraine.

## **2. Review of raw materials and industrial processes**

### **2.1. Zircon/titanium**

Subsidiary company "Irshansk State Ore Mining and Processing Enterprise" and limited company "Valky-Ilmenite" carry out titanite ore mining and concentration.

The two largest producers of titanium resources in Ukraine are the enterprises Vilnohirsk State Mining & Metallurgical Plant (VSMMP) and Irshansk GOK. Ukraine currently accounts for over 95% of titanium resource production in the former Soviet Union countries. In 2002 VSMMP produced 191,000 and 62,000 tons of ilmenite and rutile concentrate respectively (equivalent to 120,000 and 60,000 tons of  $\text{TiO}_2$ ). Irshansk GOK produced 230,000 tons of ilmenite concentrate in 2002 (127,000 tons of  $\text{TiO}_2$ ). VSMMP sells ilmenite concentrate to  $\text{TiO}_2$  and titanium sponge producers - Zaporozhe Combine. Irshansk sells ilmenite concentrate to JSC Sumykhimprom, AVISMA and  $\text{TiO}_2$  producers - GAK Titan and JSC Sumykhimprom. The biggest consumers of titanium resources are producers of titanium sponge (44%),  $\text{TiO}_2$  (35%), welding electrodes (15%) and ferro-titanium (5%).

Ukraine produces 29,000 tonnes of rutile-ilmenite coated electrodes; the leading producers are Paton Plant in Kyiv and Vostok plant in Artemivs'k (Donetsk oblast).

Relatively radioactive ilmenite contains approximately 160 Bq/kg of  $^{238}\text{U}$  and 80 Bq/kg of  $^{228}\text{Th}$ . In the mining and separation of heavy minerals, high radiation levels in tailings containing monazite can become a serious problem. The majority of the radioactivity remains in various wastes (up to 1000 Bq/kg in sludge) after chemical and thermal processing of ilmenite.

### **2.2. Use of phosphate rock for fertilizer production**

At present the most of Ukrainian fertilizers are produced at three factories:

- . Corporation "Sumychemprom" ( a phosphatic production)
- . Joint-Stock Company "CRIMEAN TITAN" (the-leading manufacturer of phosphoric mineral fertilizers in Ukraine)
- . Prydnieper factory of fertilizers

The designed capacity of Prydnieper factory after reconstruction will be 8000 tons of fertilizers monthly. It will satisfy about 60 % of the needs of Ukrainian landowners in phosphoric fertilizers. Till 1999 Prydnieper chemical factory used apatites of Kola Peninsula to manufacture phosphoric fertilizers. At present the factory does not purchase raw material from Russia and uses the Moroccan and Algerian phosphorites though they have smaller contents of active substance. In 2002 the enterprise processed 12000 tons of raw materials and produced six thousand tons of amofos from Algerian phosphorites.

Phosphate rock is the initial material for production of all phosphate products and fertilizers. In Ukraine raw materials such as apatite concentrate from Kola Peninsula (Russia) and several North African countries (Morocco and Algeria) which contain high quantities of  $^{238}\text{U}$ ,  $^{226}\text{Ra}$  and  $^{228}\text{Th}$  are used in production of phosphate fertilizers. If natural specific activity in Kola phosphorites (Russia) is 33 Bq/kg, that of Algerian, Syrian and Egyptian phosphorites is correspondingly 670-1798, 515, 335 Bq/kg, that is in tens times higher.

Impurity content in mineral fertilizers is determined by its content in the source product and production techniques. The main by-product of phosphate production is phosphogypsum in the wet process used at the fertilizer plant Table 2. The concentration of  $^{226}\text{Ra}$ , which depends on the

phosphate ore origin, is typically about 0.9 Bq/g. The average concentrations of radionuclides in phosphogypsum samples (the origin - Kola-apatite) were found to be 0.6 Bq/g for  $^{226}\text{Ra}$ , 0.7 Bq/g for  $^{238}\text{U}$ , and 0.85 Bq/g for  $^{228}\text{Th}$ . The quantity of fluorine in mineral fertilizers depends on the kind of fluorine-containing raw material from which 95 % of fluorine transfer in end product.

TABLE 2. ANALYSIS OF PHOSPHATE ROCK AND SLAG

Phosphate rock		Calcium Silicate Slag	
Dominating radioisotope	Activity concentrations, Bq/kg	Dominating radioisotope	Activity concentrations, Bq/kg
U-238	70	Th-230	2600
Th-232	100	Ra-236	2100
		Pb-210	50
		Po-210	20

### 2.3. Oil and gas exploitation

It is generally known that the oil and gas extraction and processing operations accumulate naturally occurring radioactive materials at elevated concentrations in by-product waste streams. The sources of most of the radioactivity are isotopes of U-238 and Th-232 naturally present in subsurface formations from which oil and gas are produced. The investigation on NORM assessment in some oil and gas production installations in Ukraine was undertaken. The problem of contamination of oil-gas equipment in the Dneper-Donets Basin is also considered. The mineralogy and geochemical features of the radioactive scales which form as coating and sediments on walls of the casing pipes in boreholes and other surface facility has been studied.

Within the framework of project STCU №1282, NORM precipitated on a surface of well casing and sludges that form in the water-handling equipment form Okhtyrskyi oil field facility in Sumy oblast (area) were studied.

The well casing belong to low radioactive ( $<20 \cdot 10^3 \text{Bq/kg}$ ), sludge - to highly radioactive materials. Activity of mineral substance on walls of well casing is caused by group  $^{238}\text{U}$  ( $^{226}\text{Ra}$  and others make 68 % of the total radioactivity) and group  $^{232}\text{Th}$  ( $^{232}\text{Th}$ ,  $^{228}\text{Ac}$ ,  $^{212}\text{Pb}$ ,  $^{208}\text{Tl}$  – 32 % of the total radioactivity) [3,4].

Sludge is commonly formed during oil and gas extracting and processing operations. The radioactivity of mineral substance (sludge) in water-handling equipment is almost entirely caused by group  $^{238}\text{U}$ . Radium content in mineral adjournment on walls of well casing is  $1.28 \cdot 10^{-8}\%$ . Radium content in sludge from sediment water-handling equipment makes  $(2 \div 2.4) \cdot 10^{-7}\%$ . Thorium content in mineral adjournment on walls of well casing makes  $1 \div 10\%$  [1, 2]. Thorium concentrates in hydroxide iron (mainly goethite). Concentration of thorium in sludge from sediment water-handling makes  $1.4 \cdot 10^{-3}\%$ , i.e. do not exceed thorium clarke in earth crust.

### 2.4. Coal mining and using

In Ukraine available coal reserves of operational coal mines reach 8.7 billion tons, including 6.5 billion tons of industrial coal (3.5 billion tons or 54% of energy-grade coal). There are 300 underground coal mines in the country. About 90% of coal production comes from the Donbass (which includes Luhansk and Donetsk oblasts). Coal mining is the principal activity in the southern part of the Luhansk oblast, where there are over 120 coal mines, nine of which are in and around the city of Luhansk itself. The current legislation does not regulate NORM/TENORM wastes at enterprises of no nuclear sector, because these wastes are not classified as radioactive. A lot of these wastes are accumulated in coal mining, in particular, at mines of Luhansk region. In the UNSCEAR report, the Committee estimated the average concentrations of  $^{40}\text{K}$ ,  $^{238}\text{U}$  and  $^{232}\text{Th}$  in coal to be 50, 20, 20 Bqkg-1, respectively, based on analysis of coal samples from 15 countries, and noted that the concentrations varied by more than two orders of magnitude. The concentration of uranium in the Ukrainian coal varies in the range 5–20 ppm and Th 0.5–30 ppm. The majority of the coal is used for the energy production (Fig. 4).

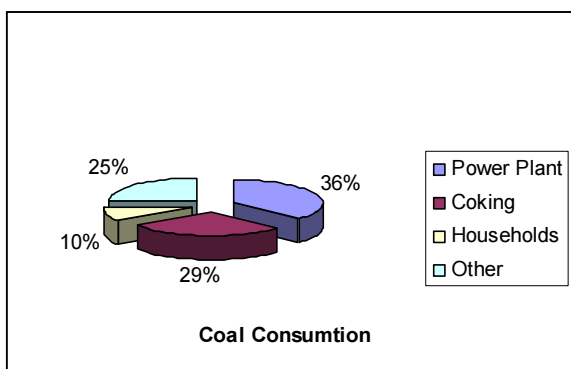

FIG. 4. Coal consumption

The U and Th are concentrated mostly in the ash and slag, about 20 ppm of Th and <12 ppm of U, is shown in Table 3. Collieries are strong sources of radon flux. At extraction of one million tons of coal nearly 3 TBk/year of  $^{222}\text{Rn}$  were emitted into the atmosphere.

TABLE 3. SPECIFIC ACTIVITY NATURAL RADIONUCLIDES IN WASTE PRODUCTS OF INDUSTRIAL PRODUCTION

Type of waste products	Specific activity of Bq/kg	
	$^{226}\text{Ra}$	$^{232}\text{Th}$
Breed after coal-cleaning plant	155	154
Breed of mountain developments of collieries	561	770
Sludges coal-cleaning plant	223	147
Ash-and-slad the boiler-houses working at a coal	140	159

Thermal power stations are sources of radioactive pollution as well. Since to produce the electric power, organic fuel is used, in particular coal. Coal contains natural radionuclides and its burning cause radionuclide release to environment and increasing levels of the background that leads to additional irradiation of the population. Data on the NORM content in Donetsk coals are presented in Table 4 [5].

TABLE 4. CONCENTRATION OF NATURAL RADIONUCLIDES IN COAL AND FLUE ASHES

Concentration of natural radionuclides, Bq/kg	$^{238}\text{U}$ decay series			$^{232}\text{Th}$ decay series	
	$^{226}\text{Ra}$	$^{222}\text{Rn}$	$^{210}\text{Po}$	$^{232}\text{Th}$	$^{228}\text{Ra}$
Coal (Donetsk area)	18,5-107	1,1-7,4	7,4-52	-	-
Flue ashes	185	-	444	85-322	122

According to statistical data in Ukraine nearby 35 million tons of coal is annually burnt and produce 10 Gwt of electric power. Estimations of emissions NORM from TEPP of Ukraine are resulted in tab. 5. According to the publication [5] the mid-annual amount of the flue ashes discharge in atmosphere from TEPP of Ukraine, working at a coal, approximately equal 150 thousand tons.

TABLE 5. ESTIMATIONS OF EMISSIONS NORM FROM TEPP OF UKRAINE,  $10^{11}$ BQ

Decision value	$^{40}\text{K}$	$^{238}\text{U}$ decay series				$^{232}\text{Th}$ decay series			Total activity
		$^{238}\text{U}$	$^{226}\text{Ra}$	$^{210}\text{Pb}$	$^{210}\text{Po}$	$^{232}\text{Th}$	$^{228}\text{Ra}$	$^{228}\text{Th}$	
According to about emissions of flue ashes	2,0	0,8	0,8	2,4	2,4	0,8	0,8	0,8	10,8
According to about the produce electric power TEPP, working at a coal	0,36	0,14	0,14	0,45	0,45	0,14	0,14	0,14	1,96

Besides use of coal to produce the electric power, a part of it is used for domestic cooking and heating of residential and industrial buildings. Considering that chimneys are placed low and are not equipped by systems of ash collecting, it is possible to assume, that 25 % of resulting ashes are thrown out into atmosphere. About 10 million tons of coal are estimated to be used in Ukraine for these purposes. The general activity of NORM is approximately equal to  $2,7 \cdot 10^{12}$  Bq/year, and the amount of radon flux will be approximately equal  $2,0 \cdot 10^{11}$  Bq/year.

### 3. Regulatory background

In Ukraine a series of regulatory documents on personnel irradiation and protection from hazardous impact of radiation has been adopted:

- The Law of Ukraine “On protection of population from ionizing radiation”;
- The Law of Ukraine “On ensuring of sanitary and epidemiological safety of population”;
- The Law of Ukraine “On nuclear energy use and radiation safety”;
- The Law of Ukraine “On labour protection”;

According to a basic definition from Norms of radiation safety of Ukraine (NRBU-97) [6].the natural sources of exposure at the enterprises can be attributed both as sources of ionising radiations and as technogenically enhanced NORM (TENORM); item 8.7.1 establishes the lists the manufactures where inevitable exposure of TENORM takes place. These radionuclides, present in the releases into air and water, may establish a risk to the population residing near an industrial site. The International Commission of Radiological Protection (ICRP) published the basic recommendations regarding principles for protection from ionising radiation. ICRP Publication [7] there is a more particular mentioning (item 218) about that the routine individual monitoring of internal exposure (the latter means applicability of rules of the 1st group) is necessary for workers. As a criterion for introduction of the 1st group it is possible to use, for example, provision 5.2.4 [7], where it is specified, that "individual dosimetric monitoring, of determined in each case content, is obligatory for individuals for whom the annual effective dose can exceed  $10 \text{ mSv} \cdot \text{year}^{-1}$ ". Concerning normalisation of a professional exposure (connected with sources of ionising radiations) within framework of rules of 4-th group, item 8.7.1 establishes the list of manufactures where inevitable exposure of TENORM takes place. This list as well as levels of obligatory actions should be defined by a separate document of the Ministry of Health of Ukraine. However, till now the specified list of manufactures and levels of obligatory actions corresponding to it are not determined [7].

At industrial enterprises the workers may undergone additional irradiation from TENORM. If the annual effective radiation dose from TENORM (excluding background radiation dose) in the production environment does not exceed  $1 \text{ mSv}$ , control and registration of the natural component for the workers is not obligatory (provision 5.1.3 NRBU-97).

## REFERENCES

- [1] BAYSAROVICH, M. et al. The Atlas "Deep Structure of Lithosphere and Ecogeology of Ukraine", Kyiv, (2002) 68.
- [2] L.V. Guseva, Radioactive-Hygienic Aspects of Pryazovie Monocytting Sands' Problem, Vestn. Hyg. Epid., 7, № 1 (2003) 114.
- [3] SHUMLAYNSKYY, V. et al., Technogenetic pollution with radioactive elements at mineral deposits, Kyiv, (2003) 134.
- [4] Soroka Yu. et al. Modern approaches to the hygienic regulation of the management with mineral raw materials, materials and waste products which contain TENORM, Vol.2, Kharkiv (2006) 53-58.
- [5] Kovalenko G., et al. Radioecology of Ukraine, Kyiv, (2001) 167.
- [6] Norms of radiation safety of Ukraine (NRBU-97).- Kyiv, Ministry of Health of Ukraine (1997) 121.
- [7] BONDARENKO, Oleg, et al., State-of-the-art and ways of solving the problems of radon dose monitoring in Ukraine, Vestn. Hyg. Epid., 8, № 3 (2004).





# **Occupational and public exposure due to naturally occurring radioactive materials (NORM) activities in France**

PIRES Nathalie <sup>a</sup>, DOURSOUT Thierry <sup>b</sup>, LORIOT Gwenaëlle <sup>a</sup>, RANNOU Alain <sup>a</sup>, CESSAC Bruno <sup>b</sup>, DESPRES Alain <sup>a</sup>

<sup>a</sup> Institute for Radiological Protection and Nuclear Safety (IRSN)  
Radiological Protection and Human Health Division  
BP n°17, 92262 Fontenay-aux-Roses, France

<sup>b</sup> Institute for Radiological Protection and Nuclear Safety (IRSN)  
Environment and Emergency Operations Division  
BP n°17, 92262 Fontenay-aux-Roses, France

**Abstract.** In France, the decree of May 25, 2005 about activities using NORM not used because of their radioactive properties imposes on the operators the assessment of effective doses received by workers and populations. Due to a significant number of industrial facilities potentially concerned, IRSN has set up an interpretative framework for the assessment of effective doses received by workers and populations.

## **1. Introduction**

Some industrial activities such as ceramic production, coal combustion in power plants or mining and ore processing for the production of metals (tin, aluminium, etc) involve the use of materials, not usually regarded as radioactive but which contain naturally occurring radionuclides (NORM). Working with these raw materials or storing them can lead to a significant increase in the exposure of workers and members of the public. This matter must be considered from the radiological protection point of view.

## **2. Regulations**

The European Commission and the French authorities have adopted regulations relative to the handling of naturally occurring radioactive materials (Council Directive 96/29Euratom [1], French decrees n° 2002-460 of April 4, 2002 [2] and n° 2003-296 of March 31, 2003 [3] relative to the radiation protection of the population and workers). These regulations impose on the operators a monitoring of the exposure and a dose assessment for workers and the general population who can be exposed.

In France, the decree of May 25, 2005 [4] about activities using NORM not used because of their radioactive properties imposes on the operators the assessment of effective doses received by workers and populations. In spite of a significant number of industrial facilities potentially concerned, this step is started only gradually. French authorities asked IRSN to evaluate the methods adopted by the operators and the radiological protection conclusions which can be drawn.

## **3. An interpretative framework**

To answer this specific request, IRSN has set up an interpretative framework for the assessment of effective doses received by to workers and populations. This framework is based on the IRSN guide for the acceptance of naturally occurring radioactive wastes in landfill sites [5] and is associated with an evaluation matrix. It is designed for the authorities to analyze the dose assessments carried out by operators concerned by the appendix 1 of the French decree of May 25, 2005.

The interpretative framework is designed to identify facilities where NORM can lead to a significant increase of workers and/or populations exposure. So, it is designed in two steps. A logical diagram is

shown in Fig. 1. The first step is an initial review of the operator study in order to check if the study is complete or if effective doses calculated by the operator are significant or if the study is a generic assessment. The study is directly sent back to the operator if it is incomplete or needs a critical analysis by IRSN.

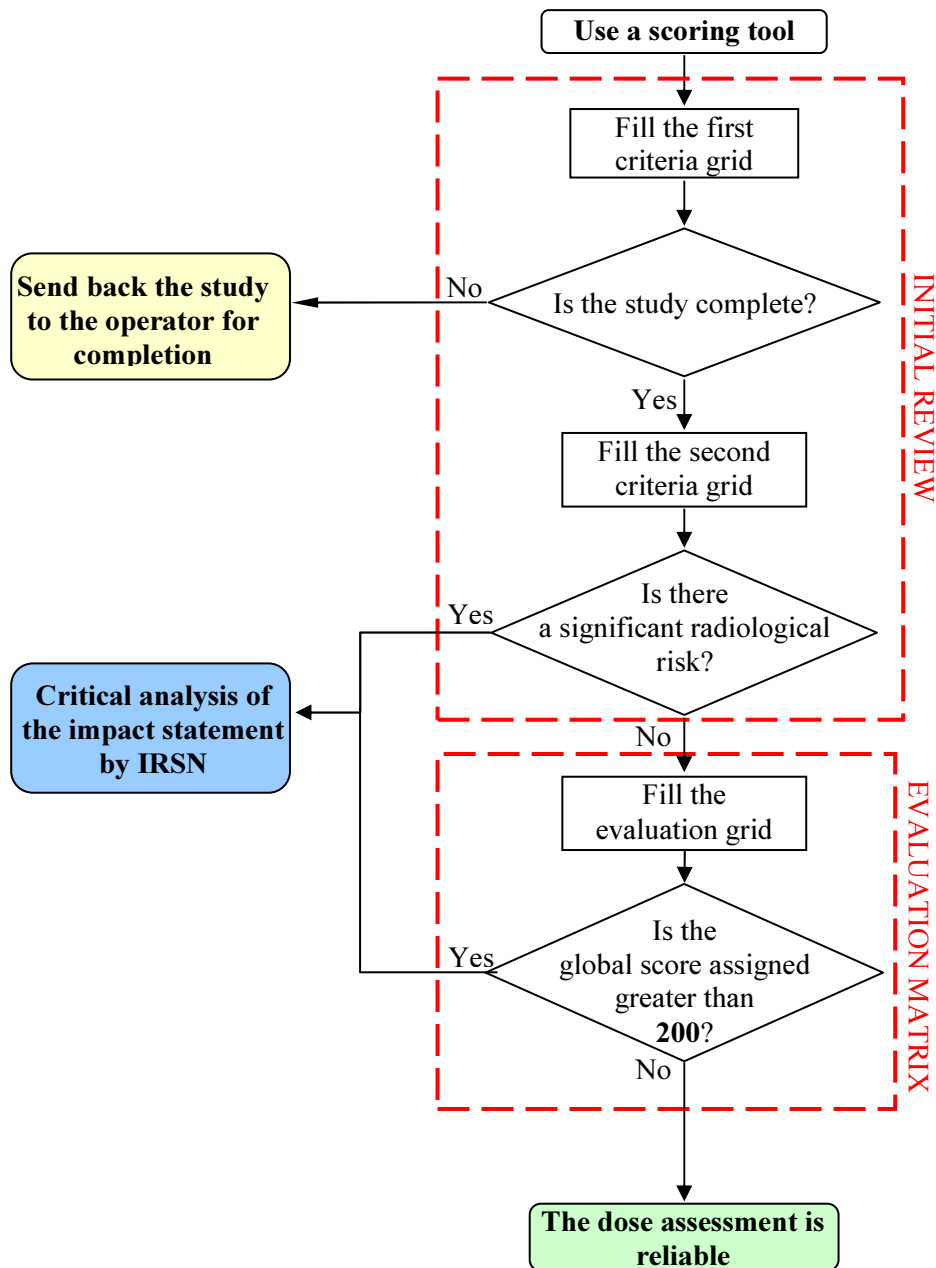

FIG. 1. A LOGICAL DIAGRAM OF THE INTERPRETATIVE FRAMEWORK

The second step is an evaluation matrix in order to link hazards and exposure. It is asked to choose between several descriptions of the physical and chemical forms of materials, of the radiological characterization, of exposure pathways ... The aim is to score the effective dose assessments presented by operators. Items of the evaluation matrix are summarized in table I.

TABLE I. THE EVALUATION MATRIX

<b>A - Characterization of materials which contain naturally occurring radionuclides</b>	
<b>• A1 – Physical forms</b>	
Raw materials, intermediate and finished products	
Waste and releases	
<b>• A2 – Radiological characterization</b>	
Raw materials, intermediate and finished products	
Waste and releases	
Measurement of radon	
<b>TOTAL</b>	<b>/40</b>
<b>B - Dose assessment for workers</b>	
<b>• B1 - Quality assessment</b>	
Identification of exposure pathways	
Consistency of effective dose presented	
Description of the industrial process	
Description of workplaces	
<b>• B2 – Effective dose for the most exposed workplaces</b>	
<b>TOTAL</b>	<b>/180</b>
<b>C - Dose assessment for populations</b>	
<b>• C1 - Quality assessment</b>	
Identification of the reference group	
Numbers of transfer pathways analysed (ground water, surface water, soil, air ...)	
Identification of exposure pathways	
Consistency of effective dose presented	
Measurement of radioactivity in the environment (ground water, surface water, soil, air)	
<b>• C2 - Effective dose for the most exposed population (reference group)</b>	
<b>TOTAL</b>	<b>/180</b>
<b>TOTAL</b>	
<b>/400</b>	

When the score is greater than 200, the study needs a careful examination and a critical analysis by IRSN. Otherwise, the assessment seems not to show a radiological protection problem and doesn't need further examination.

In spite of a significant number of industrial facilities potentially concerned, the evaluation of exposure of workers and members of the public due to NORM starts gradually. This interpretative framework needs now to be tested by French authorities.

## REFERENCES

- [1] Council Directive 96/29/Euratom of 13 may 1996 laying down basic safety standards for the protection of the health of workers and the general public against the dangers arising from ionizing radiation
- [2] Decree n° 2002-460 of April 4, 2002 relative to the radiation protection of the population
- [3] Decree n° 2003-296 of March 31, 2003 relative to the radiation protection of workers
- [4] Decree of May 25, 2005 about activities using NORM not used because of their radioactive properties
- [5] C. CAZALA et al., Guide méthodologique pour l'acceptation des déchets présentant une radioactivité naturelle dans les installations classées d'élimination, Institut de Radioprotection et de Sûreté Nucléaire (IRSN), Rapport DEI/SARG/2006-09, 2006

# Recording of legacies in the German Raw phosphate processing<sup>1</sup>

A. Reichelt<sup>a</sup>, J. Gerler<sup>b</sup>

<sup>a</sup> TÜV SÜD Industry Services, Munich, Germany

<sup>b</sup> Federal Office for Radiation Protection, Berlin, Germany

**Abstract.** An extensive historical study over the legacies of the raw phosphate processing in Germany revealed a consumption of approx. 150 million tons raw phosphates with an own production of approx. 1 million tons. This corresponds to approx. 222 million MBq U-238. The production of elemental phosphorus amounted to approx. 3 million tons (slag: 36 million MBq Ra-226) and of phosphoric acid to approx. 12 million tons (phosphogypsum: 27 million MBq Ra-226). In this way, the basis for finding concrete legacies and their radiological evaluation (measurements, exposure assessment) has been created.

## 1. Introduction

The Federal Ministry for the Environment, Nature Conservation and Nuclear Safety in Germany instigated a research project for the development of concepts for the identification and estimation of NORM legacies in Germany. The TÜV SÜD Industry Services was asked for the implementation of the project with the technical and scientific steering by the Federal Office for Radiation Protection.

The project has been carried out in 6 parts. Part 3 b is treating the industrial legacies of the phosphate ores processing in depth. Some important results from part 3 b of the project are presented in this manuscript.

## 2. Aims, methodology and execution (methods)

Raw phosphates are industrially processed in Germany approximately since the middle of the 19<sup>th</sup> century. During the centuries big amounts of residues with high mass specific activity were accumulated. We were interested in finding out where the residues exist nowadays and which amounts and activities are involved in this respect. In order to determine the historical positions and the accumulated radionuclide inventory from 1865 to 2005, the following steps have been taken:

- a) Detailed description of the various technological processes for the raw phosphate manufacturing in the chemical industry emphasizing the record of all residues as well as their reuse, disposal, storage in piles.
- b) Detailed recording of the mass specific activities of raw materials, products, residues and discharges of the phosphate industry.
- c) Description of phosphate mining in Germany (1865-1927).
- d) Historical investigation regarding production, import, export and use of raw phosphates in Germany (1865-2005).
- e) Historical investigation regarding industrial positions and production of elemental phosphorus.
- f) Historical investigation regarding industrial positions and production of phosphoric acid.
- g) Historical investigation regarding industrial positions and production of phosphate fertilizers.

---

<sup>1</sup> Work performed within the framework of the Project “Recording and radiological assessment of legacies with NORM from former practises and works activities including the model investigation of typical residues”

- h) Recording of processed amounts of phosphorite and apatite as well as their radionuclide inventory in Germany during the total historical time period.
- i) Recording of the accumulated residues amount and their radionuclide inventory (especially calcium silicate slag, ferrophosphorus, phosphogypsum, dust, gaseous effluents, liquid effluents)

The main part of the project consists of compiling the knowledge and data from historical archives (e.g. output, import), literature of chemical engineering (e.g. kind and fractions of residues) and the literature of radiation protection (e.g. activities). In the frame of the investigation, a relatively large historical time period has been taken into account.

In order to determine the quantity of NORM on the territory of the Federal German Republic within its present borders, in the historical time period beginning with the use of technology till today, the historical sources regarding courses of borders, divisions of territories, responsibilities of offices etc. have been investigated. The statistical basic material has been determined with the help of numerous library existences and archives documents as well as by means of investigations with authorities and federations.

### 3. Phosphate rocks

Phosphorus in its elementary condition cannot be found in nature, but it appears almost exclusively in its highest oxidation state as phosphate (salts of phosphoric acid) due to its high reactivity. Out of more than 200 different phosphate minerals in the soil, rocks and ocean, especially the apatite group is appropriate for the commercial production of phosphate. Apatite (FIG. 1) has a magmatic origin and possesses a particularly stable crystal lattice. It crystallizes as: fluoro apatite:  $\text{Ca}_5(\text{PO}_4)_3\text{F}$ , chloro apatite:  $\text{Ca}_5(\text{PO}_4)_3\text{Cl}$ , hydroxyl apatite:  $\text{Ca}_5(\text{PO}_4)_3(\text{OH})$ .

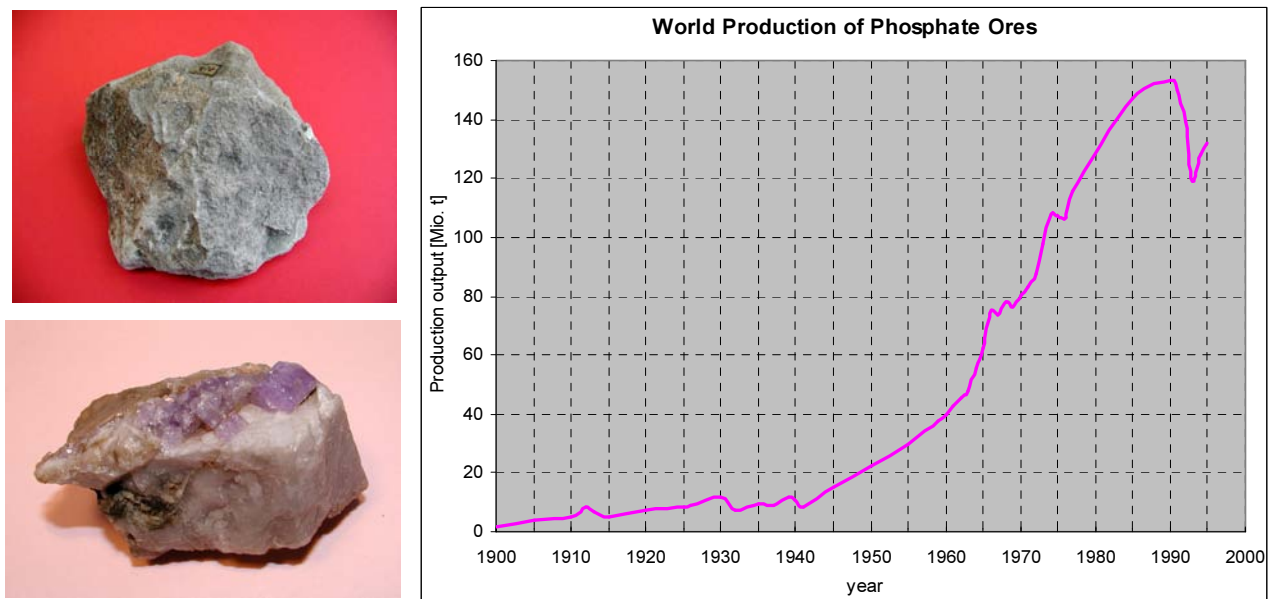

FIG. 1. Left on the top: phosphorite (Bavaria) [1], down on the left: apatite (Bohemia) [1], on the right: global production of raw phosphates (concentrates)

The main part of the phosphate deposits are however of secondary origin. These sedimentary phosphate (phosphorite - FIG. 1) deposits result from the dissolving of apatite and from precipitation (partly through a biological cycle).

The sedimentary phosphorite deposits have a 85% share of the global production, magmatic apatite deposits a 15% share. The global production of raw phosphates is shown in FIG. 1. The major producer are the United States of America, the major exporter is Morocco, major importer is Western Europe. The largest reserve is in North Western Africa.

#### 4. Technology

The knowledge of the individual technologies especially of the chemical processes is essential for the understanding of the resulted residues. FIG. 2 shows a flow chart concerning raw phosphate technology which was elaborated in the framework of the project.

The production of the phosphate ores (open pit or underground mining) stands at the beginning of the varied technological procedures. Enriched concentrates can be obtained through the beneficiation of the raw ores in the producing countries. These enriched concentrates, called raw phosphates, then are exported to chemical plants in the manufacturing countries.

The raw phosphate digestion then is effected wet chemically or thermally. On the wet chemical way, by means of various digestion acids, the fertilizing phosphates or the wet phosphoric acid are directly produced. The wet phosphoric acid is an important and basic product, especially for the production of further fertilizers but also for the production of domestic animal feed supplements. Through thermal treatment, feed supplements and fertilizer phosphates (in this case called calcined phosphates) can also be produced.

Approximately 2 % of the raw phosphate global production is processed by means of the thermal reduction to elemental phosphorus at present. Through oxidation, the „thermal“ phosphoric acid then can be obtained from phosphorus.

From phosphorus and thermal, respectively purified wet phosphoric acid, the phosphate industry produces a large range of products which are summarized in FIG. 2 to industrial phosphates, phosphorus compounds and phosphorus oxides. Important ways of application of these products are supplements of detergents and cleansing agents, water conditioning and food supplements.

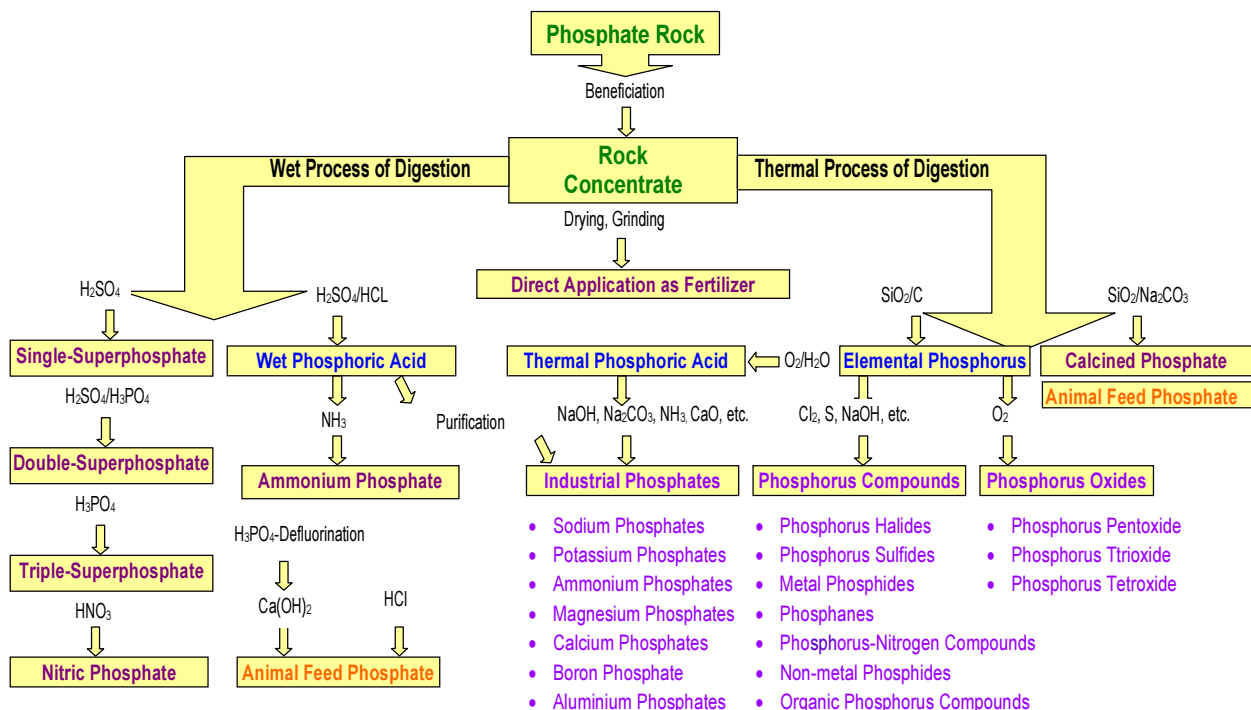

FIG. 2. Simplified flow chart of the basic technology for the processing of raw phosphates

## 5. Accumulation of residues

The spectrum of residues of the separate technologies in the phosphate industry is very large. Table 1 shows the example of the production of phosphoric acid through wet chemical digestion with sulphuric acid.

TABLE 1. RESIDUES AND BY-PRODUCTS OF THE PHOSPHATE INDUSTRY, e.g. production of phosphoric acid through wet chemical digestion with  $H_2SO_4$

Process	Residues/Byproduct
Acid Digestion with $CaSO_4$ Separation ( <i>Dorr-Oliver-Process</i> , <i>Kuhlmann-Process</i> , <i>Klinker-Process</i> )	Phosphogypsum, Deposits of Sludge in Tanks, Offgas containing fluorides, Effluent, Residues from Exhaust Scrubber, Scales, used up Filter Cloths and Components
Fluoric Recovery	Fluorosilicic acid ( $H_2SiF_6$ )
Concentration of Wet Phosphoric Acid	Offgas containing F and P, $H_2SiF_6$ -Solution
Purification of Wet Phosphoric Acid by Precipitation	Filter Cake as Precipitates containing Sulfates and Heavy Metal, Neutralisation Sludges, Charcoal Residues, Metal Hydroxides und -Silicates
Purification of Wet Phosphoric Acid by Solvent Extraction ( <i>CFB-Process</i> , <i>Hoechst-Process</i> )	Aqueous Raffinate
Defluorination of Wet Phosphoric Acid	Precipitates of $CaSiF_6$ and Phosphates polyvalent Metals, alternatively: Precipitate of $Na_2SiF_6$ or $K_2SiF_6$
Processing of Neutralisation Sludges from the Purification of Wet Phosphoric Acid by Precipitation	Residues in the course of Separation of $Fe(OH)_3$ u. $Na_2Al_2SiO_6$ by Filtration
Recovery of Uranium/Rare Earths	Uranium and Rare Earths, Residues from Precipitation and Solvent Extraction

Calcium sulphate (phosphogypsum) results from the wet chemical digestion in the production of *superphosphate* and phosphoric acid. According to the procedure and chosen acid there result different amounts (FIG. 3).

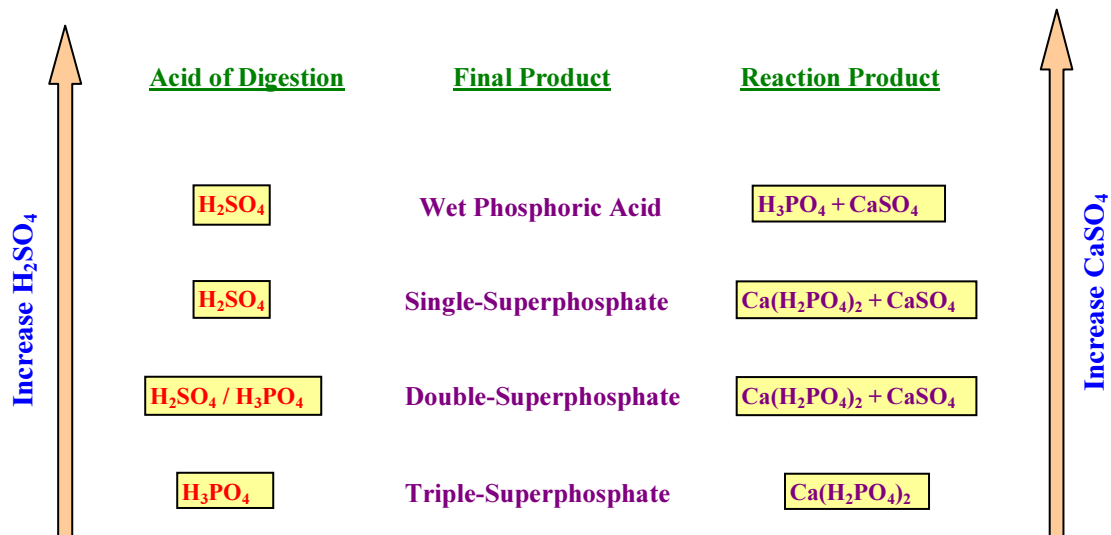

FIG. 3. Tendency of resulted phosphogypsum with the wet chemical digestion with sulphuric and phosphoric acid

FIG. 4, FIG. 5 and FIG. 6 show the quantitative resulted residues for various processes.



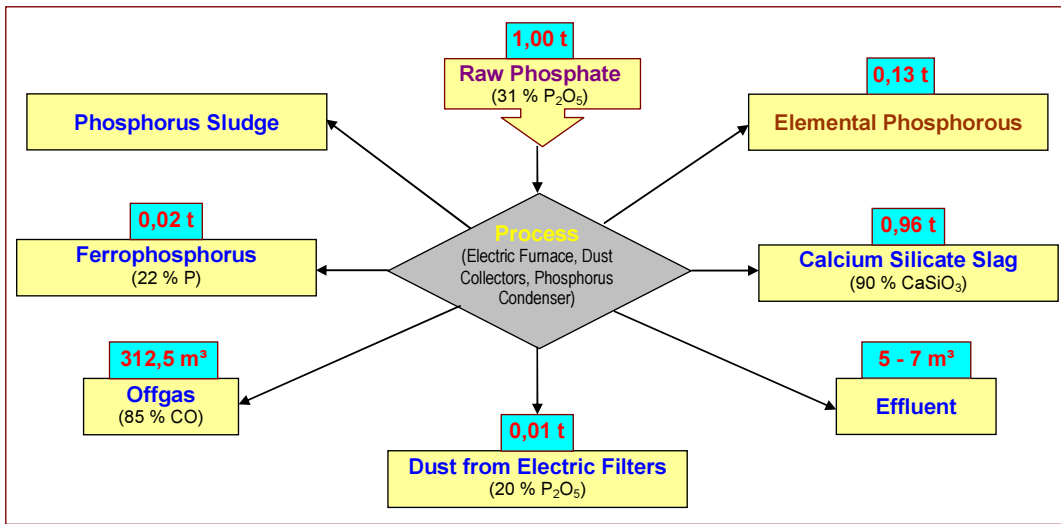

FIG. 4. Average result of products and residues at the production of elemental white phosphorus from raw phosphate (thermal digestion)

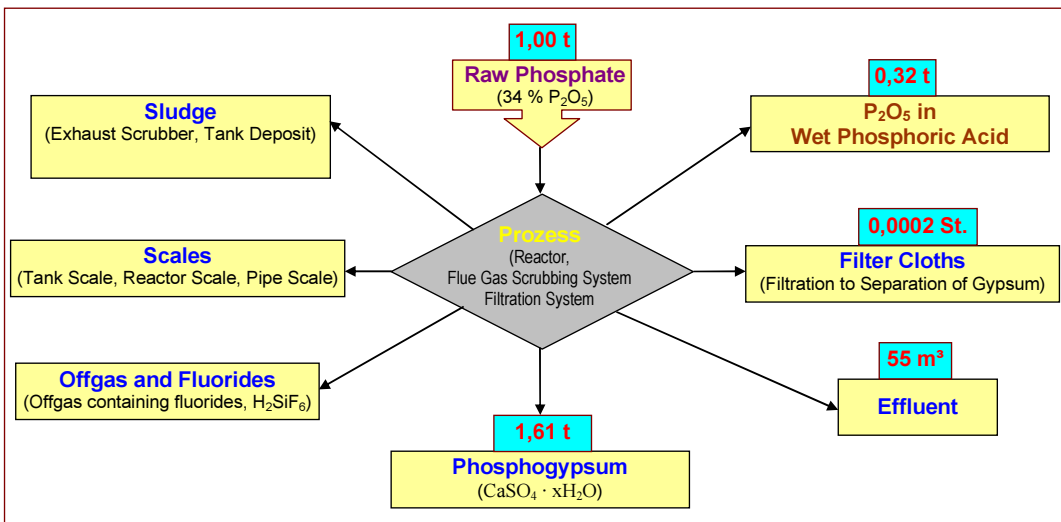

FIG. 5. Average result of product and residues at the wet chemical production of phosphoric acid from raw phosphate (sulphuric acid digestion)

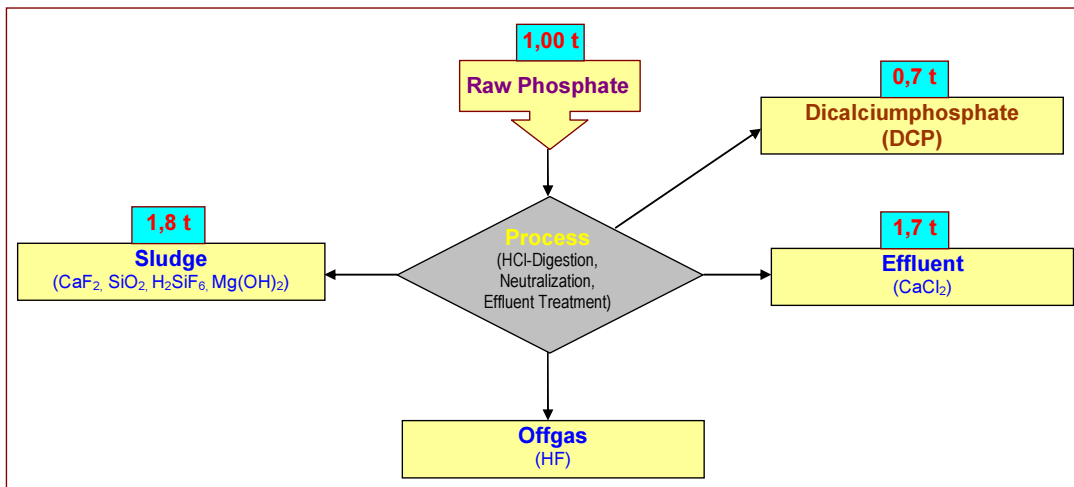

FIG. 6. Average result of product and residues at the wet chemical production of dicalcium phosphate from raw phosphate (hydrochloric acid digestion)

## 6. Activities related to the mass

The mass-related activities of relevant radiological products and residues, shown in fig. 7, have been put together after very intensive literature evaluation and own measurements.

The activity inventory of the raw phosphates are found in the products (e.g. wet phosphoric acid, fertilizer, calcium phosphates) which are generated through the wet chemical or thermal digestion procedures and are found in the residues resulted in the process.

The afterwards refined products (e.g. purified wet phosphoric acid) as well as the thermally produced elemental phosphorus inclusively the substances resulting from them (e.g. thermal phosphoric acid, detergent phosphates, food supplements) are quasi free from activity.

Relevant residues (in view of the existing amounts and mass-related activities), with the wet phosphoric acid production by means of sulphuric acid, are mainly the following: phosphogypsum and scales on parts of the components, through hydrochloric acid digestion calcium chloride instead of gypsum and calcium-fluoride. Calcium silicate slag, ferrophosphorus and filter dust are relevant at the production of elemental phosphorus.

The numbers in the small boxes are activities given in Bq/kg, on the left U-238 and on the right Ra-226. As already shown in the framework of the project, the activities of these products and of the residues are also subject to a high differentiation. While determining the average mass-related activities, there have been taken into account, for the raw phosphates during the total period of observation, the most important countries of origin for the import to Germany: the USA and Morocco.

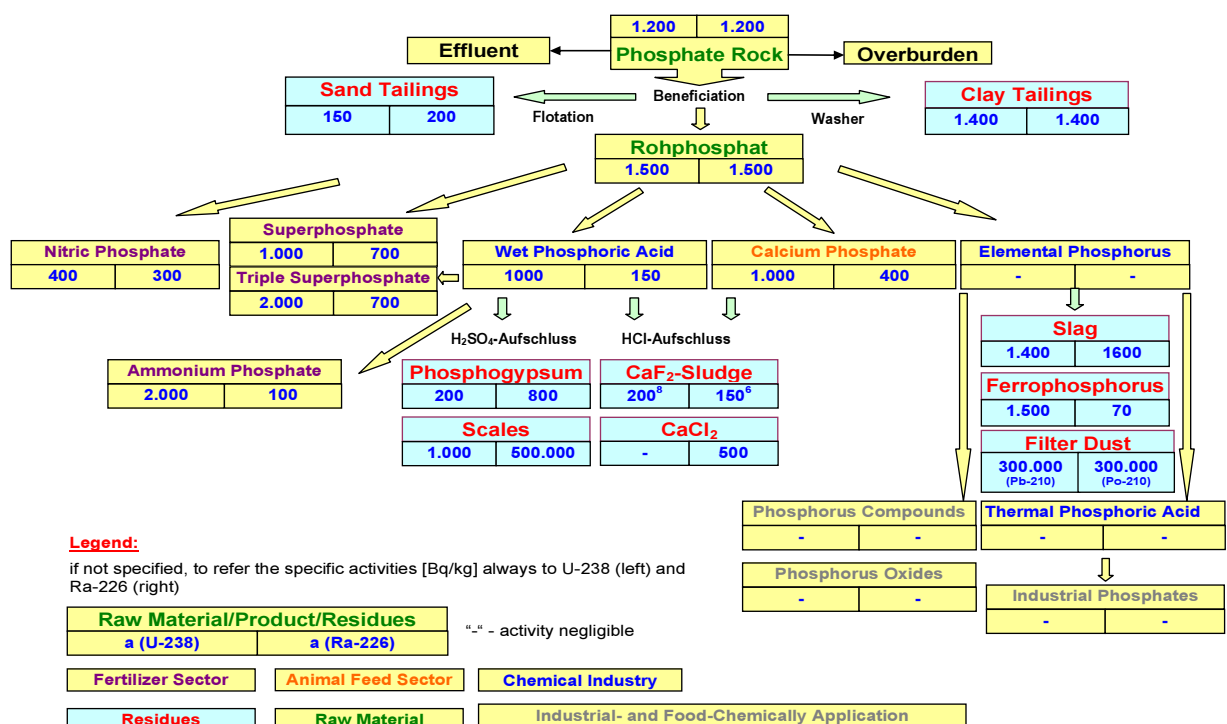

FIG. 7. Generation of radiologically important products and residues resulting from the processing of raw phosphates, giving the typical average mass-related activities [Bq/kg]

## 7. Raw phosphate use, production of elemental phosphorus, production of phosphoric acid

FIG. 8 shows the consumption of raw phosphates in Germany, calculated from the import, national production and export. This data could be determined by means of a very comprehensive historical investigation. The calculated German own production is 0,75 m. t. Fig. 9 shows in a detailed way the consumption of raw phosphate according to the purpose of use giving as example the year 1937.

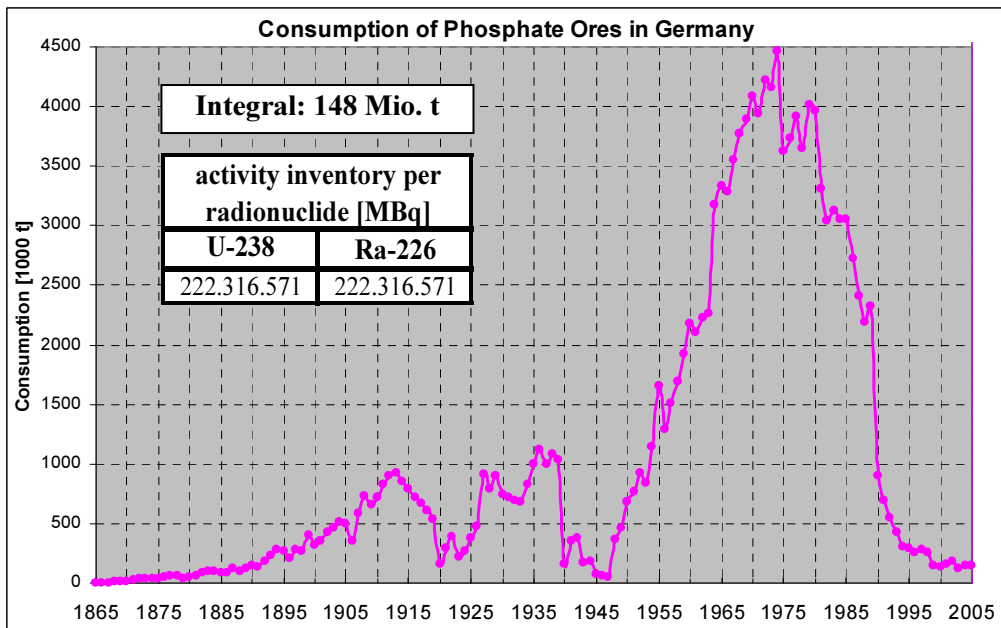

FIG. 8. Consumption of raw phosphate in Germany in the time period from 1865 to 2005

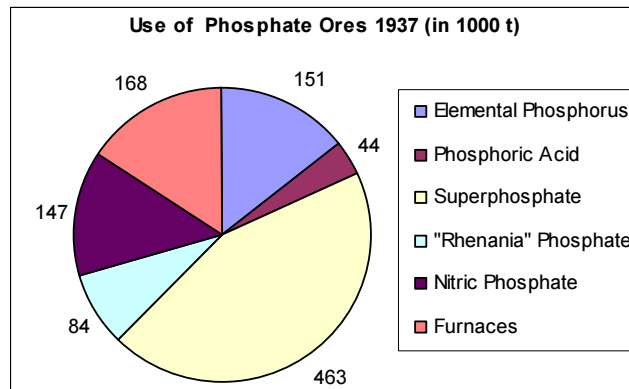

FIG. 9. Consumption of raw phosphate in 1937 according to purpose of use [2]

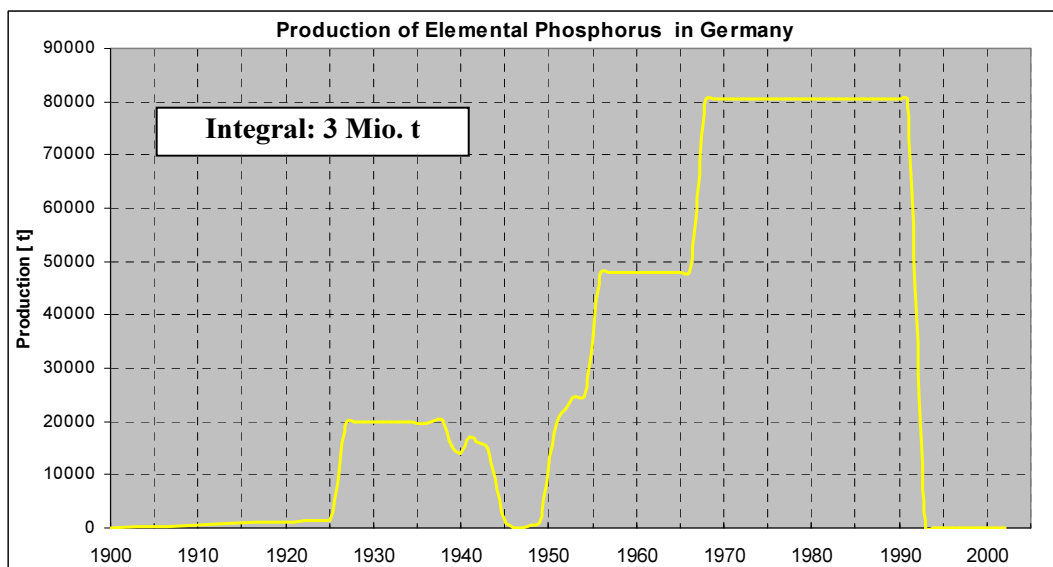

FIG. 10. Time dependent course of production of elemental phosphorus in Germany, estimated according to details given about the production [3] and the capacity of electric furnace

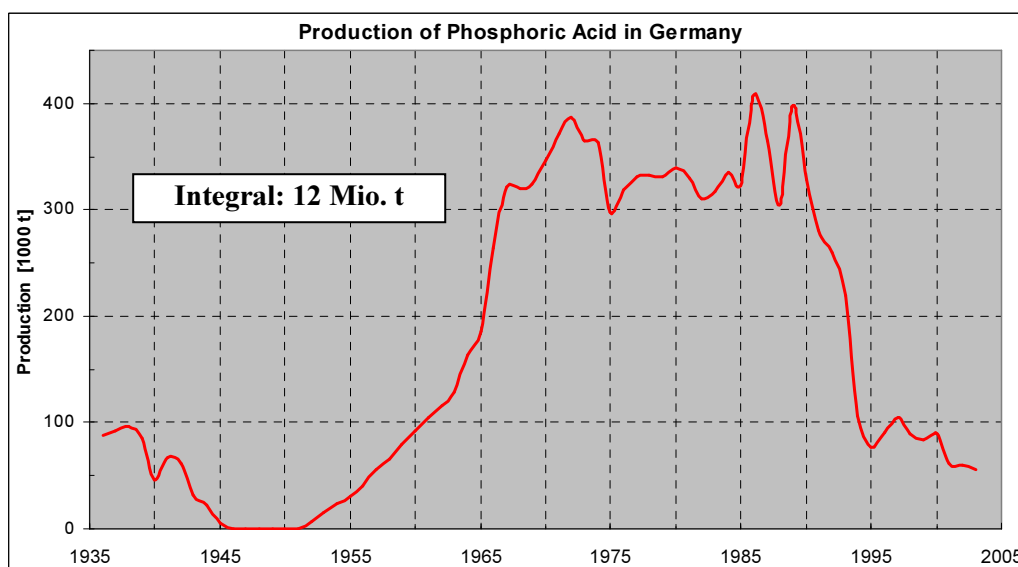

FIG. 11. Time dependent course of the production of phosphoric acid in Germany beginning with 1936; estimated according to details on production [4], [5]

FIG. 10 shows the course of the production of elemental phosphorus and fig. 11 the course of the production of phosphoric acid in Germany. Table 2 and Table 3 show the activity inventory of residues calculated from them. The determined concrete locations of the phosphate industry are examined in part 4 b of the above-mentioned project and radiological aspects are treated in part 2.

TABLE 2. ACTIVITY INVENTORY OF RESULTING RESIDUES FROM THE ELECTROTHERMAL DIGESTIONS OF RAW PHOSPHATES FOR THE PRODUCTION OF ELEMENTAL PHOSPHORUS, IN GERMANY IN THE TIME PERIOD FROM 1900 TO 2005

Residues	Activity inventory per radionuclide [MBq]			
	U-238	Ra-226	Pb-210	Po-210
Calcium Silicate Slag	31.649.274	36.170.599	.	.
Ferrophosphorus	706.457	32.968	.	.
Filter Dust	.	.	70.645.702	70.645.702
Offgas	.	.	3.061.314	9.419.427
Effluent	.	.	42.387	565.166

TABLE 3. ACTIVITY INVENTORY OF RESULTING RESIDUES FROM THE PRODUCTION OF PHOSPHORIC ACID, IN GERMANY IN THE TIME PERIOD FROM 1936 TO 2005

Residues	Activity inventory per radionuclide [MBq]	
	U-238	Ra-226
Phosphogypsum	6.837.961	27.351.844
Effluent	18.687.595	2.335.949

## REFERENCES

- [1] Minerals of the EARTH SCIENCE COLLECTION, Munich, put at disposal for photos, Munich 2006
- [2] FEDERAL ARCHIVES, Berlin, document R 31.02, 6229
- [3] FEDERAL ARCHIVES, Berlin, documents R 31.02, 6273, 3972, 6267, 6227, 3317
- [4] FEDERAL ARCHIVES, Berlin, documents R 31.02, 6273, 6191, 6229
- [5] BAVARIAN REGIONAL AUTHORITIES FOR STATISTICS AND DATA PROCESSING, Munich

# Evaluation of occupational exposure to naturally occurring radioactive materials (NORM) in the Iranian ceramics industry

Fathabadi N<sup>a</sup>, M.V.Farahani<sup>a</sup>, S.Amani<sup>b</sup>, M.Moradi<sup>a</sup>, B.Haddadi<sup>a</sup>.

<sup>a</sup> Environmental monitoring section, National Radiation Protection Department, Iranian Nuclear Regulatory Authority, Atomic Energy Organization of Iran (AEOI), Tehran, Iran

<sup>b</sup> Arak University, Department of Chemistry, Arak-Iran

**Abstract.** Zircon is naturally radioactive, containing small amounts of uranium, thorium and radium in its crystalline structure. Ceramic industry is one of the major consumers of zirconium compounds which are used as an ingredient about 10-20% by weight in glaze. In this study seven different ceramic factories have been investigated regarding the presence of radioactive elements with focus on natural radioactivity. The overall objective of this investigation is to provide information regarding the radiation exposure to workers in ceramic industry due to NORM. This objective is met by collecting existing radiological data specific to glaze production and generating new data from sampling activities. The sampling effort involves all the process of glaze production. External exposures are monitored using portable gamma ray spectrometer and environmental thermoluminescent dosimeters with time studies. Internal routes of exposure (mainly inhalation) are studied using air sampling, gross alpha and beta counting. Measurement of radon gas and its progeny is performed by continuous radon gas monitors that using pulse ionization chambers. Natural radioactivity due to the presence of <sup>238</sup>U, <sup>232</sup>Th and <sup>40</sup>K in zirconium compounds, glazes and other samples is measured by gamma spectrometry system with a high pure germanium detector. The average concentrations of <sup>238</sup>U, <sup>232</sup>Th observed in the zirconium compounds are >3300 and >550, respectively. The specific activities of other samples are much lower than in zirconium compounds. Gamma radiation levels had a mean value of approximately 0.13 mSv y<sup>-1</sup>. Dust sampling revealed greatest values in the process of powdering site and hand weighing places. In these plants, the annual average effective dose from inhalation of long lived airborne was 0.226 mSv. <sup>222</sup>Rn gas concentrations in the glaze production plant and storage warehouse were found to range from 10 Bq m<sup>-3</sup> to 213 Bq m<sup>-3</sup>. In this study, the estimated annual effective doses to exposed workers were below 1 mSv y<sup>-1</sup>.

## 1. Introduction

Most materials contain trace amounts of <sup>238</sup>U, <sup>235</sup>U and <sup>232</sup>Th, but in some naturally occurring radioactive materials (NORM), such as zircon sands, the radioactivity concentrations are at levels much higher than those usually present in the earths crust. Ceramic industry is one of the major consumers of zirconium compounds and the zirconium is fixed in the glaze. In Iran zirconium silicate is mainly used as opacifier in the preparation of ceramic glazes. Zirconium ore is not mined in Iran but imported from Italy and to a lesser extent from South Africa and Germany. The National Radiation Protection Department (NRPD) of Iran for issuing general importation permits before making use of mineral substances measure the activity concentration of taken samples from these substances. The results of activity concentrations are recorded from these data, the mean activity concentrations of natural radionuclides in zirconium compounds are summarized in Table I.

TABLE I. MEAN ACTIVITY CONCENTRATIONS OF NATURAL RADIONUCLIDES IN IMPORTED ZIRCONIUM COMPOUNDS

Compound	Mean activity (Bq/kg)		
	<sup>226</sup> Ra	<sup>232</sup> Th	<sup>40</sup> K
Zirconium silicate	2733	418	290
Zirconium oxide	1321	303	355

The radiation dose limit for Iranian workers is 100 mSv in a period of five years or in the other hand the occupational exposure of any worker was not exceeded of 20 mSv per year averaged over five consecutive years with a maximum dose of 50 msv in any single year [1]. In the case of exposure to natural radiation sources other than radon, national authorities may determine which activities require control. The main objective of this work is to evaluate the occupational exposure of workers in ceramic factories due to naturally occurring radioactive materials and to what extent the use of zirconium materials in the Iranian ceramic industry gives rise to radiological hazards. For obtaining this purpose, the following exposure path ways were considered:

- External exposure to gamma radiation;
- Inhalation of dust;
- Inhalation of  $^{222}\text{Rn}$  and progeny

Also, the specific activity determinations have been carried out on raw materials (some zircon mineral samples) and products.

## 2. Material and methods

This survey was carried out in 7 production plants of ceramic tiles and glazes. The selected plants may be considered major producers of glazes that located in different regions in Iran. As above mentioned, there are three obvious exposure pathways for persons working with zirconium compounds. These are direct exposure to gamma radiation and the inhalation of short-lived alpha emitting particles (Rn and Tn daughters) and long lived radio nuclides (generated dust).

The assessment of the external gamma exposure has been carried out in all of the glaze production process especially where zirconium silicate was deposited, stored or manually manipulated. External gamma measurements were done using fully portable handheld scintillometer, (model GR-130 with Geiger Muller (GM) tube, from Exploranium Co, LTD, Canada). The system was calibrated against a  $^{137}\text{Cs}$  standard and daily checked for stability using a low activity  $0.25\ \mu\text{Ci}\ ^{137}\text{Cs}$  (9 kBq) radioactive source. The readings are presented in terms of nanosievert per hour ( $\text{nSv h}^{-1}$ ). Moreover, in each factory the external gamma exposure dose was measured with thermo-luminescence dosimeters (TLDs). The TLDs were installed near the workplaces and the measured results provided only an average dose for a given work area and it is considered that on a shift the workers are present for only several hours or minutes at the various working places. In each factory the TLDs were installed for 6 months. In addition to that in each factory three or four TLDs were installed for 6 month to measure the gamma radiation more accurate. The average background gamma exposure level ranged from 70-110  $\text{nSv h}^{-1}$  for seven plants. These background values were subtracted from the gamma exposure levels measured in all the scenarios.

The radon gas measurements in this work were obtained from continuous radon gas monitor. Continuous measurements of radon concentrations were taken using ionizing chamber radon monitor (Alpha Guard<sup>™</sup> model PQ 2000 from Genitron Co. Ltd, Germany). Rrecords of radon concentration and other data such as date, time, temperature (T), relative humidity (RH) and barometric pressure were collected for each 10 min. The LLD of the Alpha Guard system is  $2\ \text{Bq.m}^{-3}$ . The monitors do not measure thoron gas. Short-lived alpha emitting particles (radon daughters) were measured using Radon-WL-Meter to obtain the equilibrium factor between radon and its decay products.

Long-lived radio nuclides dust levels were measured by using samplers at the exposure points and during normal works at the plant to obtain grab samples followed by radionuclide analysis to determine dust concentrations. A known volume of air is drawn through a pre-weighed membrane filter paper (47 mm diameter, pore size 5  $\mu\text{m}$ ) by means of an air pump (model MCS from SKC Co, Ltd UK) which is calibrated using a dry gas meter (model DC-HC from BIOS International Co, Ltd USA). On site, the filter holder was placed in a static position at approximately 1.6 m high (breathing zone height). Filter papers were left undisturbed for 3-4 days after their removal from the sampler (to

allow for Rn daughters to decay away) before being counted for  $\alpha$  particle activity under a proportional flow counter (model Multi-Low-Level counter FHT 770T from Eberline Co. Ltd USA). Samples were usually taken during an 8-h day-shift.

The specific activity determinations have been carried out on raw materials (zircon mineral samples and on samples of products (glazes) because the most important uses of zirconium minerals are an opacifier and pigment in glazes and colours. Activity of  $^{226}\text{Ra}$ ,  $^{232}\text{Th}$  and  $^{40}\text{K}$  in the samples from each plant was measured using a Canberra High Purity Germanium (HPGe) detector. Detector is surrounded by a massive lead shield (10 cm) with internal walls of electrolytic copper and cadmium and coupled to a Canberra MCA-Series 100. The system was calibrated with respect to energy and efficiency using reference materials (RGU-1), (RGTh-1) and (RGK-1) that were prepared from International Atomic Energy Agency (IAEA). The relative efficiency of detector is 40% and its energy resolution is 2 keV at full width half maximum (FWHM) from 1332 keV energy of  $^{60}\text{Co}$ . Samples were first dried, weighed (300gr) and then covered securely and placed in polyethylene cylindrical gas-tight containers three weeks prior to counting. At the end of ingrowth's period, the samples were counted for 3-16 h depending on their activity levels.  $^{226}\text{Ra}$  was determined by means of its progeny photo peak:  $^{214}\text{Bi}$  (609 keV).  $^{232}\text{Th}$  was analyzed by means of its progeny photo peak:  $^{208}\text{Tl}$  (583 keV). The activity of  $^{40}\text{K}$  was measured directly through its 1461 keV peak [2].

### 3. Results and discussion

#### 3.1. Radionuclide activity concentration

Radionuclide analysis of raw material (zirconium silicate) and products (ceramic glazes) that collected from different plants are presented in table II.

The table shows the radionuclide content of zircon varies according to the origin of zircon. The  $^{226}\text{Ra}$  concentration in zircon ranging from 3300 to 4600 Bq kg<sup>-1</sup>. It is necessary to mention that ceramic tiles usually contain small amounts of zirconium compounds (thin glazed layer) and therefore are not a case of concern from the radio protection point of view.

TABLE II. RADIOACTIVITY CONCENTRATIONS IN RAW MATERIALS AND PRODUCTS

Plant	Exporting country	Mean specific activity (Bq kg <sup>-1</sup> ) in raw material (Zirconium silicate)			Mean specific activity (Bq kg <sup>-1</sup> ) in ceramic glaze (frit)			
		$^{226}\text{Ra}$	$^{232}\text{Th}$	$^{40}\text{K}$	$^{226}\text{Ra}/^{232}\text{Th}$	$^{226}\text{Ra}$	$^{232}\text{Th}$	$^{40}\text{K}$
LMSH	England	3900	700	-	5.5	880	190	1580
LIRA	Italy	3800	670	-	5.6	630	160	670
KIMI	Italy & Spain	4000	690	-	5.8	550	100	720
LSMA	Italy	3500	550	55	6.4	420	90	520
LSMB	Italy	3500	550	55	6.4	470	100	580
SERA	Germany & South Africa	4100	600	260	6.8	480	90	1190
IRAA	Italy	3300	600	54	5.5	370	80	620

### 3.2. Gamma radiation measurements

External gamma measurements were done with two instrument types. External gamma dose rate in the plants environs were measured using the portable survey meter. Measured dose rate ranged from 80 nSv h<sup>-1</sup> to 1500 nSv h<sup>-1</sup> in different work areas. The maximum dose rates were observed in bulk storage. Measured dose rate on the surface of zircon packages was about 2800 nSv h<sup>-1</sup>.

For each plant, several background measurements have been taken. The ambient gamma dose rate recorded outside the perimeter of the plants and used as a control measurement of the natural background (70-100 nSv/h). The average gamma radiation dose was calculated to be less than 0.2 mSv y<sup>-1</sup>. Also the local dose was measured with TLDs that were installed near the work places. These places were: bulk storage, hand weighing and mixing, engobe production and products storage. The exposure time was considered carefully that on a shift the workers were present for only several hours and minutes at the various working places.

Radiation dose arising from exposure to external gamma radiation of terrestrial origin for workers involved in the selected plants are presented in table III. Annual external dose ranged from 0.036 to 0.2 mSv/y.

TABLE III. AVERAGE GAMMA DOSE RATE MEASUREMENTS IN 7 DIFFERENT PLANTS AND EFFECTIVE DOSES.

Plant	Average Dose rate (μSv/h)	Average Effective dose (mSv/a)
LMSH	0.106	0.160
LIRA	0.034	0.056
KIMI	0.047	0.070
LSMA	0.120	0.176
LSMB	0.130	0.195
SERA	0.136	0.199
IRAA	0.024	0.036

### 3.3. Radon gas measurements

The results for the concentrations of radon are presented in table IV. For each plant, the average, maximum and minimum of these values are reported. The values of annual effective dose equivalent were estimated based on a dose conversion factor of 1.43 mSv per mJh m<sup>-3</sup> obtained from ICRP Publication 65 [3]. The exposure duration in each plant was calculated to be 750 to 2000 h. At all plants, the concentrations of radon are below 400 Bq m<sup>-3</sup> and they are similar to outdoor radon concentration except for two cases. At two plants (KIMI and LSMB) only in bulk storages, the average radon concentrations were 213 and 149 Bq/m<sup>3</sup> respectively. This is because of the storage of large amounts of raw materials in poorly ventilated places (allowing radon concentration to build up). As the exposure time for the workers who work in the bulk storages are short (2-3 hours in one day) and also using mechanical ventilation with high ventilation rate, there weren't any radiological significant from the point of view of radon occupational exposure in the plants.



The annual effective dose from inhalation of radon and its decay products in different locations throughout the plants was calculated for the levels measured in the plants and by taking in to account the exposure duration at each location (Table IV). The highest dose calculated would be received in the LSMA plant and is 0.13 mSv.

TABLE IV. RADON CONCENTRATION MEASUREMENTS AND ASSOCIATED AVERAGE ANNUAL EFFECTIVE DOSES.

Plant	Radon concentration (Bq/m <sup>3</sup> ) [mean (min-max)]	Average of F-factor	Effective dose from radon inhalation(mSv/a)
LMSH	[11 (10-12)]	0.48	0.062
LIRA	[42 (6-79)]	0.15	0.08
KIMI	[26 (12-41)] <sup>a</sup>	0.31	0.09
LSMA	[29 (7-52)] <sup>b</sup>	0.4	0.13
LSMB	[7 (5-10)]	0.26	0.021
SERA	[12 (9-15)]	0.28	0.038
IRAA	[12 (8-17)]	0.3	0.042

<sup>a</sup> Value of 213 Bq m<sup>-3</sup> not included

<sup>b</sup> Value of 149 Bq m<sup>-3</sup> not included

### 3.4. Airborne dust concentration

In most of the investigated cases of NORM at work places usually refers to the inhalation of contaminated dust as a major pathway by workers. The dustiest locations of the plants were found to be the powdering site, mixers and hand weighing places. The potential radiation doses from inhaled dust are based on the exposure duration (assumed to be 750 to 2000 h/a) and a standard breathing rate of 1.2 m<sup>3</sup>/h. A default activity median aerodynamic diameter (AMAD) particle size of 5 μm was assumed [3]. According to these assumptions and using the activity ratio of <sup>226</sup>Ra:<sup>232</sup>Th in dust (both uranium and thorium and the radionuclide in the dust were in equilibrium), the total inhaled activity expressed as gross alpha activity in thorium and uranium series were determined [4] and with dose conversion factors of 3.5 μSv/Bq for uranium and 8 μSv/Bq for thorium series [5], the potential dose from inhaled dust was calculated to be less than 0.7 mSv/a. The results of the calculations are shown in table V.

Employees working in these areas are required to wear personal protective equipments (PPE) including protective clothing and face dust masks.

TABLE V. THE AVERAGE LONG LIVED AIRBORNE ALPHA ACTIVITY CONCENTRATION AND EFFECTIVE DOSE FROM INHALATION OF AIRBORNE DUST.

Plant	average long lived airborne alpha activity concentration (Bq/m <sup>3</sup> )	effective dose from inhalation of dust (mSv/a)
LMSH	0.001	0.056
LIRA	0.050	0.225
KIMI	0.0184	0.091
LSMA	0.0670	0.34
LSMB	0.142	0.70
SERA	0.0740	0.36
IRAA	0.0018	0.013

#### 4. Conclusions

The doses arising from different pathways calculated in the framework of this study are shown in Table VI.

TABLE VI. OCCUPATIONAL RADIATION DOSE CALCULATED FOR THE WORKERS IN SEVEN CERAMIC PLANTS IN IRAN.

Plant	Annual effective dose (mSv)		
	Dust inhalation	External gamma irradiation	Total
LMSH	0.056	0.160	0.216
LIRA	0.0225	0.056	0.078
KIMI	0.091	0.070	0.161
LSMA	0.34	0.176	0.516
LSMB	0.70	0.195	0.895
SERA	0.36	0.199	0.599
IRAA	0.013	0.036	0.049
Mean	0.226	0.127	0.36

The different scenarios for estimating the occupational dose received by workers in the production of ceramic glazes in different plants show that exposure due to inhalation of particles is the most important contribution and after that the exposure due to external gamma rays is important. The mean total annual effective dose likely to be received by a worker involved in the processing of the glaze

production in ceramic industry is approximately 0.36 mSv (360  $\mu$ Sv). As it is clear that the reference dose value of 1 mSv/y is not exceeded for these workers. In fact the exposures identified are lower than those recommended for public exposure [6]. However, there are some exceptions (in bulk storages) where radon and gamma exposure rates increased but it is clear that if remedial action has to be taken in these places (for example, mechanical ventilation with high ventilation rates and reduction of workers exposure time) the annual effective dose associated with these workers won't be significant.

#### REFERENCES

- [1] IRANIAN NUCLEAR REGULATORY. Basic radiation safety standards. NRPD-BRSS- 1, National Radiation Protection Department, Tehran (1999).
- [2] GHIASSI-NEJAD, M., et al., Concentration of Natural Radionuclides in Imported Mineral Substances. *Environ. Int.* 26, 1-4 (2001).
- [3] INTERNATIONAL COMMISSION ON RADIOLOGICAL PROTECTION, Protection against Radon-222 at home and at work, ICRP Publication 65, Pergamon Press, Oxford (1993)
- [4] HARTLEY, B.M., The Measurement of Radiation Levels in Australian Zircon Milling Plants. *Health Phys.* 80(1), 16-23 (2001).
- [5] INTERNATIONAL ATOMIC ENERGY AGENCY SAFETY STANDARDS SERIES, Occupational Radiation Protection in the Mining and Processing of Raw Materials, Safety Guide No, RS-G-1.6, Vienna, (2004).
- [6] INTERNATIONAL COMMISSION ON RADIOLOGICAL PROTECTION, Recommendations of the International Commission on Radiological Protection. ICRP Publication 60, Ann. ICRP 21(1-3), Pergamon Press, Oxford (1991)



# A method to evaluate gamma-spectrometric measurements of NORM samples

J. Mantero<sup>a</sup>, S. Hurtado<sup>b</sup>, G. Manjón<sup>a</sup>, R. García-Tenorio<sup>a</sup>

<sup>a</sup>Applied Nuclear Physics Group  
University of Sevilla  
Avenida Reina Mercedes s/n  
41012-Sevilla, Spain

<sup>b</sup>Centro de Investigación, Tecnología e Innovación (CITIUS)  
University of Sevilla  
Avenida Reina Mercedes 4b  
41012-Sevilla, Spain

**Abstract.** Although a detailed and well-defined monitoring programme should be carried out in order to evaluate properly occupational doses in industrial activities involving NORM, a first estimation about the dose levels susceptible to be received by the workers can be performed with basis in the knowledge of the radioactivity content of the materials involved or produced in the analysed industrial processes (ores, by-products, scales, sludges,..). The dose estimations performed through the commented approach demand the application of proper and accurate measuring techniques. In this sense, it is well known that gamma-ray spectrometry provides a fast and simple method for the measurement of a good set of natural radionuclides belonging to the Uranium and Thorium series. The multi-elemental and non-destructive character of this technique makes it superior, in many cases, to more traditional and skill based radiochemical procedures. Nevertheless, two main tasks arise when this technique should be applied for the measurement of NORM samples: a) the proper management and interpretation of the complex gamma-ray spectra obtained from the measurements, and b) the accurate determination of the photopeak efficiencies at different energies for each sample. This last task is far from be straightforward in a laboratory devoted to the measurement of NORM samples due to their great variability in the available amounts of material (geometry source-detector) and in their densities (self-absorption). In the present work the method used in our laboratory to evaluate the gamma-spectrometric measurements of NORM samples is detailed. This method is based in the determination for each sample of the photopeak efficiency versus energy curve by applying a Monte Carlo simulation (using the GEANT4 simulation toolkit) and in the application of a procedure for correcting serious spectral interferences present on several gamma-ray peaks of interest. The whole method has been checked via the analysis of various NORM samples and the comparison of the obtained results with the obtained ones by applying more sophisticated and tedious radiometric techniques.

## 1. Introduction

Industrial activities may use and/or generate naturally occurring radioactive material (NORM) along their production process. The quantification of this natural radioactivity is needed in order to estimate, as a first approach, occupational doses in those activities. Gamma-ray spectrometry is a multi-elemental and non-destructive technique that provides a simple and fast method to measure radioactivity in different NORM samples.

Two main drawbacks arise from the utilization of gamma-ray spectrometry technique. First of all an alternative efficiency calibration has to be developed to overcome high cost and time consuming experimental calibration involving NORM samples with different volume and composition. In this work, a Monte Carlo simulation technique (using GEANT4 code) has been used to perform efficiency calibration of germanium detector. Previously an optimization of detector dimensions has been made to obtain correct efficiency values. Additionally, self-absorption corrections due to different composition and measurement geometries of NORM samples have been taken into account through transmission experiments of non-collimated point sources [1, 2].

In addition, several peak interferences appear in natural spectra of NORM samples. For that reason a detailed spectral analysis needs to be carried out to extract proper activities from the radioisotopes belonging to the Uranium and Thorium series.

Various NORM samples have been analysed in order to check the accuracy of the present method. The gamma results were compared with the obtained ones by applying more sophisticated and tedious radiometric techniques as alpha spectrometry to aliquots of the same samples.

## 2. Experimental procedure

Measurements were performed with a Canberra n-type Reverse electrode Germanium (ReGe) detector, with a relative photo-peak efficiency of 30% at 1332 keV. The preamplified signals from the detector are sent to a Canberra Spectroscopy Amplifier model 2020 and , afterwards, to a Canberra ADC model 8701 connected to an Accuspec™ card. Gamma-ray peaks are analysed using Genie2K. Point sources used ( $^{241}\text{Am}$ ,  $^{137}\text{Cs}$  and  $^{60}\text{Co}$ ) for transmission experiments were supplied by PTB (Germany).

The measured samples (17 samples) were contaminated superficial sediments from the Odiel river (O labelled samples), the Tinto river (T labelled samples) and from the junction of both rivers (OT labelled samples), and were collected in 2005. The sampled zones have been historically affected by the releases of a phosphoric acid factory located close to the Huelva city, in the south west of Spain

The samples, after collection, were dried to the warm temperature of 50°C to avoid the volatilisation of the  $^{210}\text{Po}$ . After that, they were ground, packed in Petri dish geometry and sealed with silicone gel to avoid the radon emanations from the Petri box. Finally, the samples were stored for more than 30 days in order to achieve secular equilibrium between radon ( $^{222}\text{Rn}$  with  $T_{1/2}=3.824$  days) and its progenies ( $^{214}\text{Pb}$  and  $^{214}\text{Bi}$ ) with radium ( $^{226}\text{Ra}$ ).

The releases of the Huelva fertiliser factory were enriched in radionuclides of the uranium series (no enrichment in the thorium series), fact that was taken into account in the approaches considered for evaluation of the complex spectra obtained.

## 3. Monte Carlo simulation

Monte Carlo (MC) methods allow the calculation of full-energy peak efficiency (FEP) by reproducing with fidelity any detector-source configuration [3]. However, usually exact sample composition of the NORM samples is not known and additional techniques (TTPIXE, XRF...) for its determination are required. An alternative option consists in the use of a collimated beam [4], or a non-collimated one [5], to obtain linear attenuation factors ( $\mu$ ) and consequently FEP efficiencies via MC calculation.

In our case, taking air height as source, we have first calculated FEP for different energies using MC simulation. In this way, we avoid individual calculation for each sample. Afterwards, self-attenuation correction factors to the FEP values have been calculated for each real sample using a transmission experiment with non-collimated point sources for a wide energy range. The combination of both quantities gives us corrected FEP information for each sample analysed, and consequently allows us the determination of the sample activity for any isotope.

### 3.1. Full-energy peak efficiency calculation

GEANT4 code (v.8.1) was used to simulate the detector-sample configuration. The internal dimensions of the detector were optimized using a well checked procedure [6] in order to obtain accurately FEP for any energy and measurement geometry. The main disadvantage of the efficiency calculation by using Monte Carlo method is the not sufficient reliability in detector parameters provided by the manufacturer. The efficiency values computed with the supplied detector data deviate significantly (5–10%) from the experimental data for all the measuring geometries. Therefore, the detector parameters have to be optimised in order to obtain better agreement among computed and experimental data.

The main optimisation strategy consists of a comparison between experimental and calculated FEP efficiency for different detector parameter set-ups using point sources at strategic positions and following a well defined procedure. The detector model constructed in that way can be used to compute the efficiencies for any geometry set-up, specifically empty Petri dish geometry with different heights.

### 3.2. Self-absorption corrections

The corrected FEP is calculated at different selected energies using [7]:

$$\varepsilon = f\varepsilon_0 \quad (1)$$

Where  $\varepsilon_0$  is FEP calculated using MC simulation of an empty Petri dish for different sample heights, and  $f$  is the self-absorption correction factor. The  $\varepsilon_0$  values at each energy of interest, are fitted using a polynomial of order two in function of sample height ( $t$ ) [8] allowing us to obtain FEP ( $\varepsilon_0$ ) for the radionuclides of interest as function of sample height. .

Self-absorption correction factors ( $f$ ) are calculated, experimentally, for each real sample using:

$$f = (1 - \exp(-\mu t)) / (\mu t) \quad (2)$$

where  $t$  is the sample height and  $\mu(E)$  is the linear attenuation coefficient, that depends on the energy and is calculated using a transmission experiment.

For  $f$  determination, the Petri dish containing each sample is located at 1.1 cm above detector window and several calibrated point sources ( $^{241}\text{Am}$ ,  $^{137}\text{Cs}$  and  $^{60}\text{Co}$ ) are located on top of each sample. Then  $\mu(E)$ , at different energies, is calculated using the following expression for every emission:

$$\ln(I_0 / I) = \mu t \quad (3)$$

where  $I_0$  is the net count rate in the peak at energy  $E$  without sample and  $I$  is the net count rate with sample. Finally self-attenuation correction factors, for each real sample and each selected energy, are calculated using Eq. (2), while for each real sample the dependence of  $f$  with the energy can be obtained by non-linear weighted fitting for whole energy range to:

$$f = a + b / E + c / E^2 \quad (4)$$

This allows us to correct the  $\varepsilon_0$  for each sample and emission energy (see Fig. 1). In order to check the accuracy of Eq. (4) to represent  $f$ , coefficient  $\mu$  for a standard sediment composition was extracted from XCOM database [9] and used to calculate  $f$  for a height of 1 cm. The equation fit shows a good agreement (see Fig. 1).

### 4. Spectral analysis

Once the corrected FEP ( $\varepsilon$ ) values at different energies were obtained using Eq. (1), a non-linear least-square fit to a log-log function (FEP vs. energy) was made to calculate sample activity  $A$ :

$$A = \frac{N}{t \cdot \varepsilon \cdot I \cdot w} \quad (5)$$

Where  $A$  is the activity concentration of a certain radionuclide expressed in  $\text{Bqkg}^{-1}$ ,  $N$  includes the net counts of a photopeak,  $\varepsilon$  is the FEP counting efficiency of the used detector at the energy of the photopeak considered (taken from the corrected FEP vs energy fitted function),  $t$  is the live time in seconds,  $I$  is the photon intensity and  $w$  is the dried sample weight expressed in kg,

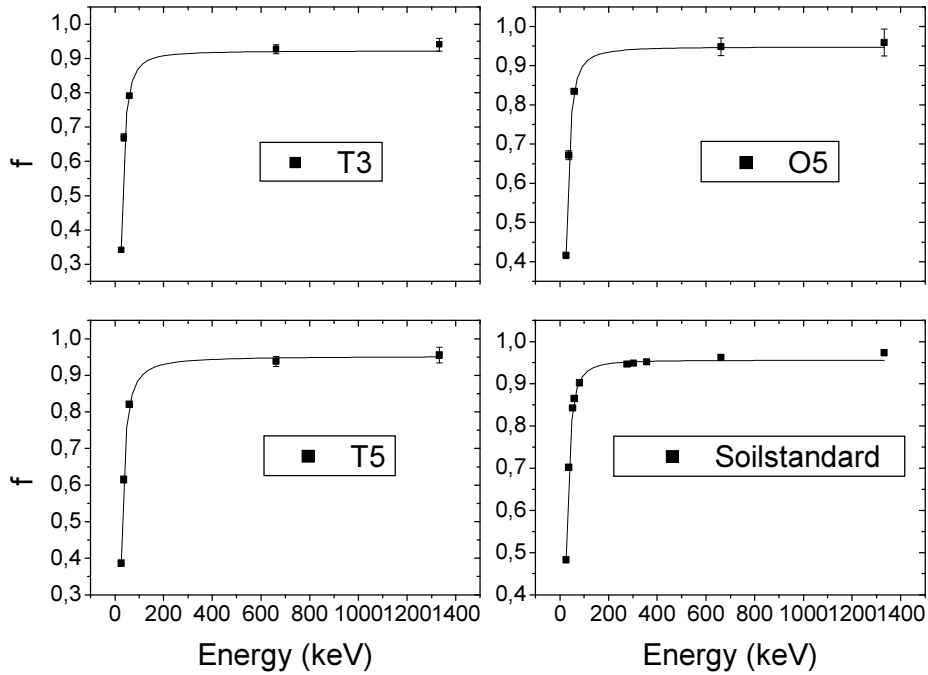

FIG. 1. Transmission factors ( $f$ ) fitted to Eq. (4) for whole energy range and different sediment samples (samples T3, O5 and T5 and standard soil composition).

All the measurements were done during a live time from 100.000 to 200.000 seconds, with dead times ranging from 0.01% to 0.08%. In the spectra where no peaks of  $^{235}\text{U}$  were found, the minimum detectable activity (MDA) was calculated according to Currie [10] [11].

The activity concentration of  $^{238}\text{U}$  was determined from the  $^{234}\text{Th}$  photons at 63.29 keV [12-14]. No corrections by interferences of  $^{231}\text{Th}$  at 63.9 keV [15] or  $^{232}\text{Th}$  at 63.9 keV were applied due to their low photon intensities. On the other hand, the activity of  $^{232}\text{Th}$  has been evaluated by the gamma emission of  $^{228}\text{Ac}$  (911.2 keV) [16].

For activity determination of  $^{235}\text{U}$  via gamma, three different gamma lines (and consequently, three methods) have been used. The first used gamma line was the one emitted at 205.3 keV (5.01% of photon intensity). Despite its low intensity, and due to the time that the contaminated samples were measured, enough statistics have been obtained in this photopeak. No corrections by  $^{227}\text{Th}$  interferences (energies of 204.27 keV with 0.20% of peak emission probability, 205.03 keV with 0.15%, and 206.11 keV with 0.21%) were considered due to its negligible influence. The second used gamma line from  $^{235}\text{U}$  was the one emitted at 163.4 keV with 5.08 % of emission probability. In this case we have not considered the  $^{231}\text{Th}$  interference at 163.1 keV with 0.155% intensity because, at maximum, it only would suppose a 3 % of the counting rate of the photoelectric peak at this energy [17]. Finally, the third method uses the  $^{235}\text{U}$  gamma emission at 143.8 keV which has an emission probability of 10.96 %. This peak has significant interferences from the  $^{223}\text{Ra}$  emission at 144.23 keV (intensity 3.22 %), and for its appropriate correction a similar method that the one described in [16] has been used. Figure 2 shows schematically this correction procedure, which starts with the determination of the  $^{223}\text{Ra}$  activity in the sample from the 154 keV photopeak, and continues (with basis in the previous determination) with the subtraction of the  $^{223}\text{Ra}$  contribution to the 144 keV photopeak. In this way, the net counts of  $^{235}\text{U}$  in the 144 keV photopeak are obtained and the  $^{235}\text{U}$  activity can be calculated using:



$$A(^{235}\text{U}_{143.76\text{keV}}) = \frac{N_{143\text{keV photopeak}} - N_{154\text{keV photopeak}} \frac{\epsilon_{^{223}\text{Ra}(144.23\text{keV})} \cdot I_{^{223}\text{Ra}(144.23\text{keV})}}{\epsilon_{^{223}\text{Ra}(154.2\text{keV})} \cdot I_{^{223}\text{Ra}(154.2\text{keV})}}}{t \cdot \epsilon_{^{235}\text{U}(143.76\text{keV})} \cdot I_{^{235}\text{U}(143.76\text{keV})} \cdot W} \quad (6)$$

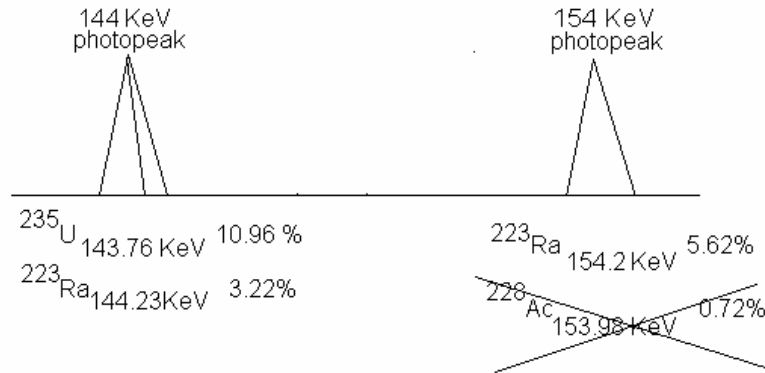

FIG. 2. Schematic representation which shows the correction procedure of the  $^{235}\text{U}$  gamma line at 143.76 keV by  $^{223}\text{Ra}$ . The interference of the  $^{228}\text{Ac}$  gamma emission at 154 keV is neglected due to its low emission probability and the low levels of radionuclides from the thorium series in the analysed samples.

## 5. Results

The results obtained during the analysis of the superficial contaminated sediment samples collected in the Huelva estuary are compiled in Table 1. It is observed that the activity concentrations of  $^{232}\text{Th}$ , are relatively uniform along both rivers and their junction, being in addition, similar to the typical values obtained in unperturbed sediments (11–64 Bq/kg) [18]. On the contrary, the activity concentrations of  $^{238}\text{U}$  are, in most cases, clearly higher than those found in uncontaminated estuarine sediments, with values up to 400 Bq/kg (typical values of U and daughters in uncontaminated sediments are 16–110 Bq/kg [18]). The contamination from Uranium is clear along both rivers, while the samples collected in their junction contain more usual levels of this element.

The  $^{238}\text{U}$  and  $^{232}\text{Th}$  results obtained by gamma-ray spectrometry have been confirmed and validated by determining the activities of these radionuclides in aliquots of the analysed samples by alpha-particle spectrometry (see Figure 3). A good agreement for all measurements has been obtained, validating the method developed in this work. On the other hand, the isotopic ratios  $^{238}\text{U}/^{235}\text{U}$  in the analysed samples has been calculated for the three  $^{235}\text{U}$  methods shown in this work. These values have been compared with the natural value (about 22) expected in the same samples (Figure 4). The results obtained by gamma-ray spectrometry using the three different methods for  $^{235}\text{U}$  determination are close to natural value about 22, with the exception of few samples (OT3, OT4 and OT5) characterised for their low levels of U.

TABLE I.  $^{238}\text{U}$ ,  $^{232}\text{Th}$  AND  $^{235}\text{U}$  ACTIVITY CONCENTRATION ( $\text{Bq kg}^{-1}$ ) OBTAINED BY GAMMA-RAY SPECTROMETRY IN THE CONTAMINATED SEDIMENT SAMPLES ANALYSED. The  $^{235}\text{U}$  results shown in the table are the average of the results obtained by the 3 methods presented in this work.

Sample	Activity concentration ( $\text{Bq kg}^{-1}$ )		
	$^{238}\text{U}$	$^{232}\text{Th}$	$^{235}\text{U}$ Mean of three methods
O2	104.7(20.5)	24.0(4.4)	12.4(7.6)
O3	100.9(19.0)	35.3(6.7)	6.9(4.7)
O4	375.5(72.6)	40.7(9.5)	20.7(10.2)
O5	415.2(72.7)	61.4(10.8)	27.7(8.4)
O6	174.8(29.8)	35.2(5.5)	8.2(3.7)
O7	111.7(19.4)	25.8(4.2)	10.9(7.8)
OT1	112.5(21.7)	35.9(9.8)	4.7 (3.0)
OT2	91.2(15.3)	34.2(5.5)	6.3(2.4)
OT3	61.1(14.5)	27.4(6.4)	10.3(6.6)
OT4	1.6 (M.D.A.)	3.5(1.0)	7.4(4.0)
OT5	18.9(6.6)	14.7(2.6)	5.7(3.4)
T2	195.4(33.2)	39.6(6.2)	6.9(3.7)
T3	221.9(39.3)	27.4(4.9)	16.3(8.2)
T4	305.3(53.7)	35.3(7.6)	26.2(9.0)
T5	120.6(27.2)	42.6(6.8)	8.1(4.1)
T6	351.0(61.2)	35.7(6.6)	21.8(6.6)

## 6. Conclusions

A method for activity determination of gamma-emitters in NORM samples by gamma-ray spectrometry with a coaxial germanium detector has been proposed. In this method efficiency calculation for different sample volume and composition (self-absorption corrections) are taken into account. Only an extra transmission experiment per sample is needed for FEP determination regardless of sample height and emission energy.

The accuracy and precision of the proposed method has been checked calculating the activities of several natural radionuclides in sediment samples from an estuary located in the vicinity of a phosphoric acid factory. In these samples the natural levels have been previously determined independently using an alternative radiometric technique (alpha spectrometry).

## Acknowledgments

Financial support from the Spanish Security Council (CSN) is specially acknowledged.

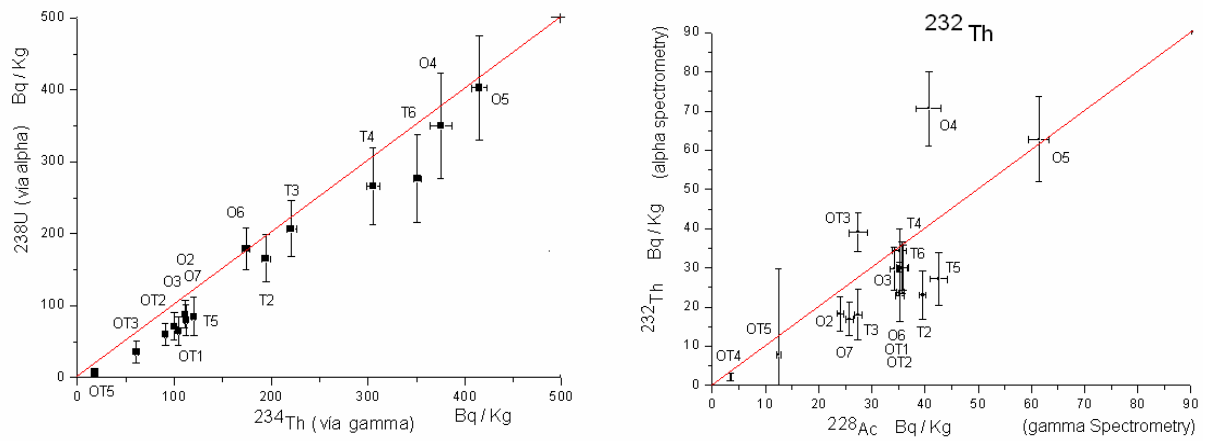

FIG. 3.  $^{238}\text{U}$  and  $^{232}\text{Th}$  activities measured by gamma-ray and alpha spectrometry in the analysed sediment samples.

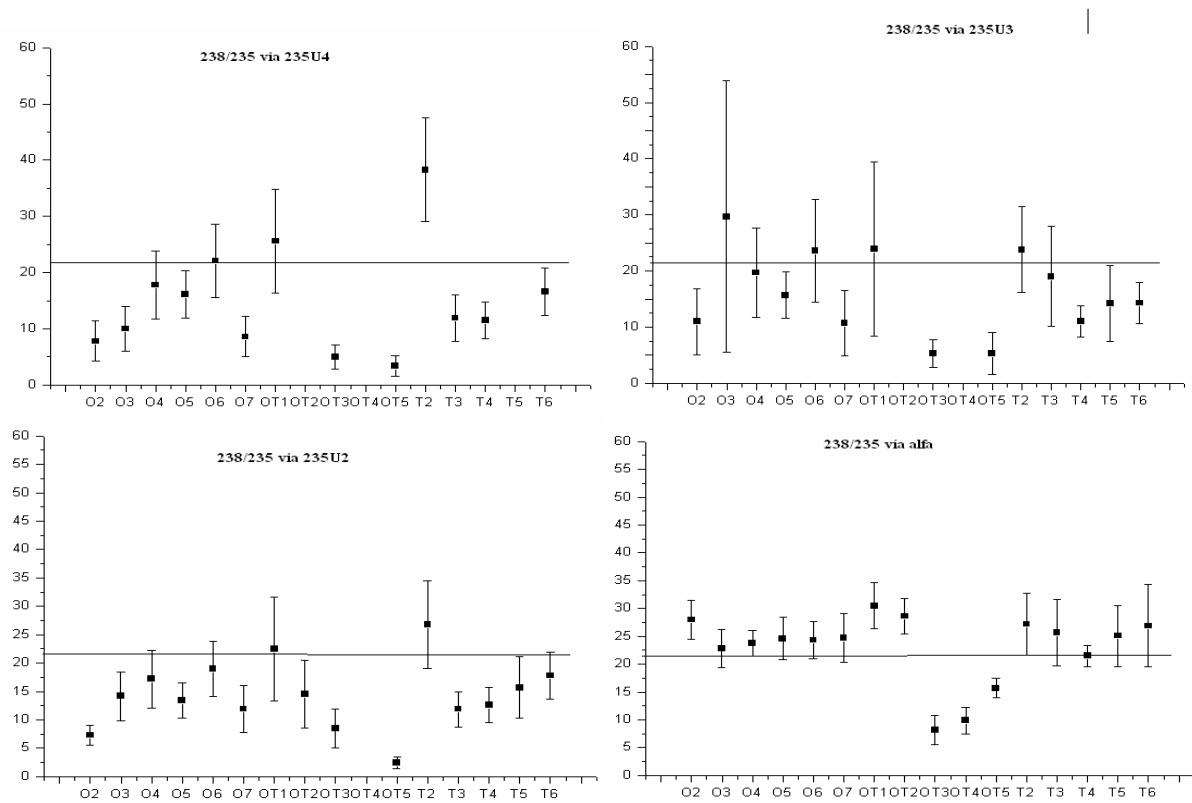

FIG. 4.  $^{238}\text{U}/^{235}\text{U}$  activity ratios using three methods shown in this work (via  $^{235}\text{U}_4$ , via  $^{235}\text{U}_3$  and via  $^{235}\text{U}_2$ ) and alpha spectrometry (via alpha) for different samples.

## REFERENCES

- [1] Cutshall, N.H., Larsen, I.L., Olsen, C.R., Direct analysis of  $^{210}\text{Pb}$  in sediment samples: Self-absorption corrections, Nucl. Instr. and Meth. A **206** (1983) 309–312.
- [2] Joshi, S., Determination of  $^{241}\text{Am}$  in sediments by direct counting of low-energy photons, Intern. J. Radiat. Appl. Inst. A **40** (1989) 691–699.

- [3] Sima, O., Arnold, D., Self-attenuation and coincidence-summing corrections calculated by Monte Carlo simulations for gamma-spectrometric measurements with well-type germanium detectors, *Appl. Radiat. Isot.* **47** (1996) 889–893.
- [4] Overwater, R.M.W., Bode, P., de Goeij, J.M., Gamma-ray spectroscopy of voluminous sources Corrections for source geometry and self-attenuation, *Nucl. Instr. and Meth. A* **324** (1993) 209–218.
- [5] Garcia-Talavera, M., Peña, V., A hybrid method to compute accurate efficiencies for volume samples in  $\gamma$ -ray spectrometry, *App. Rad. Isot.* **60** (2004) 227-232.
- [6] Hurtado, S., García-León, M., García-Tenorio, R., GEANT4 code for simulation of a germanium gamma-ray detector and its application to efficiency calibration, *Nucl. Instr. and Meth. A* **518** (2004) 764-774.
- [7] Hurtado, S., Villa, M., Manjón, G., García-Tenorio, R., A self-sufficient and general method for self-absorption correction in gamma-ray spectrometry using GEANT4, Accepted for publication in *Nucl. Instr. and Meth. A.* (2007)
- [8] San Miguel, E.G., Perez-Moreno, J.P., Bolivar, J. P., Garcia-Tenorio, R., Martin J.E.,  $^{210}\text{Pb}$  determination by gamma spectrometry in voluminal samples (cylindrical geometry), *Nucl. Instr. and Meth. A* **493** (2002) 111-120.
- [9] Berger, M.J., Hubbell, J.H., Seltzer, S.M., Coursey, J.S., Zucker, D.S. XCOM: photon cross section database (1999) (version 1.2). <http://physics.nist.gov/xcom> National Institute of Standards and Technology, Gaithersburg, MD.
- [10] Currie, L.A., Limits for quantitative detection and quantitative determination, *Anal. Chem.* **40** (1968) 586-593.
- [11] El Afifi, E.M., Hilal, M.A., Califa, S.M., Aly, H.F., Evaluation of U, Th, K and emanated radon in some NORM and TENORM samples, *Radiation Measurements* **41** (2006) 627-633.
- [12] García- Talavera, M., Evaluation of the suitability of various gamma lines for the gamma spectrometric determination of  $^{238}\text{U}$  in environmental samples, *Applied and Isotopes* **59** (2003) 165-173
- [13] Karangelos D.J., Anagnostakis M.J., Hinis E.P., Simopoulos S.E., Zunic Z.S, Determination of depleted uranium in environmental samples by gamma-spectroscopic techniques, *Journal of Environmental Radioactivity* **76** (2004) 295-310
- [14] Huy N.Q., Luyen T.V., A method to determine  $^{238}\text{U}$  activity in environmental soil samples by using 63.3 keV-photopeak-gamma HPGe spectrometer, *Applied Radiation and Isotopes* **61** (2004) 1419-1424.
- [15] Firestone, R.B., Table of Isotopes, 8th Edition, Wiley, NewYork, 1996.
- [16] De Corte, F., Umans H., Vandenberghe, D., De Wispelaere, A., Van den Haute, P., Direct gamma-spectrometric measurement of the  $^{226}\text{Ra}$  186.2 keV line for detecting  $^{238}\text{U}/^{226}\text{Ra}$  disequilibrium in determining the environmental dose rate for the luminescence dating of sediments, *Applied Radiation and Isotopes* **63** (2005) 589-598.
- [17] Miki Shoji, Yasunori Hamajima, Kiyofumi Takatsuka, Hirishi Honoki, Tomoko Nakajima, Takashi Kondo, Takashi Nakanishi, A convenient method for discriminating between natural and depleted uranium by gamma-ray spectrometry, *Applied Radiation and Isotopes* **55** (2001) 221-227.
- [18] United Nations. Sources and effects of ionizing radiation. United Nations Scientific Committee on the Effects of Atomic Radiation, 2000 Report to the General Assembly, with scientific annexes. United Nations, New York..

# Improvements in the liquid scintillation counting techniques for the measurement of NORM samples

F. Mosqueda<sup>a†</sup>, M. Villa<sup>b</sup>, G. Manjón<sup>c</sup>, F. Vaca<sup>a</sup>, J. Pates<sup>d</sup>

<sup>a</sup>Dpto. de Física Aplicada. Facultad de Ciencias Experimentales.  
Universidad de Huelva.  
Campus de El Carmen.  
21007-Huelva, Spain

<sup>b</sup> Centro de Investigación, Tecnología e Innovación. CITIUS  
Universidad de Sevilla  
Avenida Reina Mercedes 4B  
41012-Sevilla, Spain

<sup>c</sup> E. T. S. Arquitectura. Departamento de Física Aplicada II  
Universidad de Sevilla.  
Avenida Reina Mercedes s/n  
41012-Sevilla, Spain

<sup>d</sup> Department of Environmental Science  
Lancaster University.  
Lancaster, LA14YQ, United Kingdom  
41012-Sevilla, Spain

**Abstract.** LSC is an easy and fast method for the measurement of  $^{226}\text{Ra}$  and  $^{210}\text{Pb}$ , and it can compete, in time and effort, with other fast techniques, such as gamma-ray spectrometry, for  $^{226}\text{Ra}$  and  $^{210}\text{Pb}$  activity determination. Nevertheless, the evaluation of the radiochemical yield becomes extremely important when applying liquid scintillation counting to the measurement of  $^{226}\text{Ra}$  and  $^{210}\text{Pb}$  activities in sediments, soil and complex matrices. Due to the complexity of the matrices, it is necessary to use an internal tracer standard and/or carrier, and the accuracy of the results depends on the method followed to evaluate it. Methods based on the coprecipitation of  $^{210}\text{Pb}$  and  $^{226}\text{Ra}$  using lead and barium sulphates are widely used, and the addition of carrier and weighing the recovered amount is a widespread technique to evaluate radiochemical yield, although this evaluation of the recovery is sometimes questioned. Therefore, the techniques applied to evaluate the recovery of Ra and Pb in the co-precipitation method should be thoroughly studied. In our laboratory the sulphate precipitation method is used to measure both  $^{226}\text{Ra}$  and  $^{210}\text{Pb}$ , however, some problems have been encountered when applying the method of mass precipitate measurement to different kinds of NORM and TENORM; if the radiochemical yield is calculated from the final weight of the sulphate precipitate we find that it is not always as accurate as desired. The aim of this paper is double: on one hand, different methods for the evaluation of the radiochemical yield have been tried out in order to determine effectiveness and accuracy in relation to the phosphogypsum samples measurement. And on the other hand, different techniques of measurement, such as gamma-ray spectrometry or Cerenkov counting, have been applied to the measurement of NORM samples to confirm the accuracy of the liquid scintillation measurement methods employed in our laboratories.

## 1. Introduction

Phosphogypsum is a TENORM that contains elevated concentrations of radionuclides from 238U- and 232Th-decay natural series [1]. In order to assess the spread of this contamination, methods are required to obtain accurate results within short time scales. Liquid scintillation counting (LSC) is a competitive alternative to other spectrometric techniques for the measurement of  $^{210}\text{Pb}$  and  $^{226}\text{Ra}$  activities, two of the most important natural radionuclides from a radioecological point of view. Using LSC it is possible to obtain results with uncertainty below 5%, with short times for radiochemical preparation, counting and analysis [2, 3].

---

<sup>†</sup> Corresponding author

According to [4] and [5],  $^{226}\text{Ra}$  and  $^{210}\text{Pb}$  can be measured following a sequential sulphate precipitation method and measuring by LSC, and radiochemical yields can be estimated by determining the mass of the final sulphate precipitates. Therefore, this should be a rapid method, suitable for routine control measurements in NORM and TENORM samples. However, the evaluation of the radiochemical yield through precipitate mass weighing might not be as accurate as desirable. When using a gravimetric method to evaluate the radiochemical yield, it is necessary to take into account two factors. First of all, the dissolution of the  $\text{PbSO}_4$  or  $\text{BaSO}_4$  precipitate and mixing with scintillator cocktail might not be 100% effective. Secondly, the sulphate precipitate may not be pure and stoichiometric (more likely in the  $\text{BaSO}_4$  precipitate), biasing the result. Therefore, when more accurate and precise data are needed, an alternative method for recovery calculations might be adopted.

This work presents an overview of the different methods that have been set up in Huelva and Sevilla laboratories, for the recovery evaluation of radium and lead in the co-precipitation method.

Last of all, the LSC methods are applied to the evaluation of activity concentrations of  $^{226}\text{Ra}$  and  $^{210}\text{Pb}$  in sediment samples affected by phosphogypsum discharges. The values obtained through LSC have been compared to the results obtained using alternative techniques (gamma-ray spectrometry or Cerenkov counting). The accuracy and precision of the methods set up for liquid scintillation measurements have been tested.

## **2. Materials and methods**

### **2.1. Sample description**

Samples affected by phosphogypsum releases will be used in this study to determine the activity concentrations of  $^{226}\text{Ra}$  and  $^{210}\text{Pb}$ . The samples have enhanced activity concentrations of the natural emitters from the  $^{238}\text{U}$ - and  $^{232}\text{Th}$ -decay series, as they have been collected in Huelva Estuary, an area affected by former phosphogypsum discharges, released by direct discharges from the phosphoric acid factories and also from the lixiviation of open-air piles close to the rivers where the phosphogypsum was stored. A map of the area and the distribution of the contamination can be found for example in [1, 3].

### **2.2. Instrumentation**

$^{226}\text{Ra}$  and  $^{210}\text{Pb}$  were measured by LSC and  $^{210}\text{Pb}$  was also determined by Cerenkov counting. In both cases, two different liquid scintillation counters were used and the results are compared. Both instruments use pulse shape analysis (PSA) to separate  $\alpha$ - and  $\beta$ - events.

A Perkin Elmer Tri-Carb 3170 TR/SL is located at the University of Huelva. The PSA function in this instrument is a “pulse decay discriminator” (PDD) setting, which is optimised to achieve separation and simultaneous counting of  $\alpha$ - and  $\beta$ -events. A Perkin Elmer Quantulus 1220 is located in the University of Sevilla (CITIUS research centre). To obtain the best separation between  $\alpha$ - and  $\beta$ -events, the PSA threshold level is adjusted with values that range from 1 to 256.

Stable lead and barium concentrations were determined using quadrupole ICP-MS (Agilent 7500c) provided with a Babington nebuliser, located at the University of Sevilla (CITIUS research centre).

Gamma spectrometry measurements were performed in the Department of Environmental Science at Lancaster University, with a coaxial HPGe detector, model GEM-15190.

### 2.3. Radiochemical procedure

The radiochemical procedure for  $^{210}\text{Pb}$  and/or  $^{226}\text{Ra}$  separation follows a sulphate precipitation method following the method described in [3]. Briefly, after dissolution of the sample, carriers were added, stable lead for  $^{210}\text{Pb}$  and stable Ba for  $^{226}\text{Ra}$ , and sulphates were precipitated by the addition of dilute  $\text{H}_2\text{SO}_4$ . The Ra-Pb-BaSO<sub>4</sub> precipitate was collected by filtration and then re-dissolved using EDTA. Selective re-precipitation of Ra-BaSO<sub>4</sub> was obtained by adjusting the solution to pH = 4.5, using glacial acetic acid, and of PbSO<sub>4</sub> by adding  $\text{H}_2\text{SO}_4$  to pH = 3. In all cases, precipitates were dissolved using EDTA in ammonia medium.

For LSC, the sample volume was adjusted to 9 ml and then mixed with scintillator (Optiphase Hisafe 3) such that the vial was completely full. This is done to avoid  $^{222}\text{Rn}$  losses into an air space at the top of the vial, which is important when measuring  $^{226}\text{Ra}$ .

For Cerenkov counting of  $^{210}\text{Pb}$ , the radiochemical procedure it is identical, and when sample volume is adjusted to 9 ml, MilliQ water is added to the vial to complete 20 ml [6,7].

### 2.4. Measurements and radiochemical yield evaluation

For the measurement of  $^{226}\text{Ra}$ , some days must be waited to reach secular equilibrium with the daughters. We measure the full alpha spectrum that comprises  $^{226}\text{Ra}$ ,  $^{222}\text{Rn}$ ,  $^{218}\text{Po}$  and  $^{214}\text{Po}$ . Activities concentration (Bq/kg) are calculated from,

$$A(^{226}\text{Ra}) = \frac{R_{\alpha}}{\varepsilon \cdot Y \cdot \delta_{226}(t)} \quad (1)$$

Where  $R_{\alpha}$  is the net counting rate in total alpha spectrum window,  $\varepsilon$  is the counting efficiency corrected by  $\alpha$ - $\beta$  interference.  $Y$  is the radiochemical yield and  $\delta_{226}(t)$  is the correction to  $N_{\alpha}$  due to the contribution from  $\alpha$ -emitters descendants of  $^{226}\text{Ra}$ , which depends on the time passed since the sample preparation and the measurement. It can be calculated using the Bateman's equations. As the samples were measured 28 days after the radium separation, when secular equilibrium is reached,  $\delta_{226}(t) \sim 4$ .

Using the  $^{210}\text{Pb}$  spectrum window (1-350 channels),  $^{210}\text{Pb}$  activity concentration (Bq/kg) for an immediate measurement is obtained as follows,

$$A(^{210}\text{Pb}) = \frac{R_{1-350}}{\varepsilon \cdot Y \cdot m \cdot 60} \quad (2)$$

Where  $R_{1-350}$  is the net counting rate (in *cpm*) in  $^{210}\text{Pb}$  spectrum window.

A widespread technique [4, 5, 8] for recovery evaluation in the previously described method consist on the weighing of the final mass of the Pb(or Ba)SO<sub>4</sub> precipitate, after adding a known amount of carrier. To obtain the radiochemical yield from the precipitate of BaSO<sub>4</sub> or PbSO<sub>4</sub>, it has been made a calibration curve, stable lead mass versus radiochemical yield. A more detailed description of the calibration is presented in [2].

We are interested in checking when it is possible to estimate radiochemical yields using the weight of mass of the final precipitates. For that purpose, alternative techniques were also applied to obtain the recovery calculations.

ICP-MS technique it is used for the evaluation of Pb recovery after separation, we have measured stable lead from the  $\text{PbSO}_4$  precipitate after it is dissolved using EDTA. For Pb and Ba quantification, an aliquot from each sample is diluted 1:20 v:v to a 1%  $\text{HNO}_3$  matrix. The analyses were run according to the methodology proposed by U.S. E.P.A 200.8 protocol.

It is not possible to use any Ra isotope as internal tracer; however, an alternative option is using the EC emitter  $^{133}\text{Ba}$ .  $^{133}\text{Ba}$  emissions are discriminated from alpha events and are presented in beta window. When  $^{226}\text{Ra}$  is measured in the alpha window, it is possible to obtain simultaneously  $^{133}\text{Ba}$  spectrum in the beta channel and radiochemical recovery can be inferred from that spectrum. Details of the full calibration using  $^{133}\text{Ba}$  as internal tracer are given in [3].

### 3. Results and discussion

Yields from ICP-MS and weight are presented in Figure 1 and data are fitted to a linear function using least-square method. The calculated slope is  $0.972 \pm 0.021$ , which is very close to unity, within the uncertainty. ICP-MS is a reliable technique to measure stable lead, however, according to these results, gravimetric method also provides accurate results for recovery calculations and therefore, could be used as alternative to the ICP-MS technique if necessary.

Results for  $^{226}\text{Ra}$  recoveries from weighting  $\text{BaSO}_4$  mass, are compared to radiochemical yields calculated using  $^{133}\text{Ba}$  as internal tracer. The results here differ notably from the  $^{210}\text{Pb}$  case. On one hand not all the data shown can be fitted to a linear function, and some outliers are found in the graph. The calculated slope  $0.842 \pm 0.017$  is not as close to one as desirable. For that reason, radiochemical yields for  $^{226}\text{Ra}$  measurements in our lab would be evaluated adding  $^{133}\text{Ba}$  as internal tracer.

If the radiochemical method stated to determine  $^{226}\text{Ra}$  is adding  $^{133}\text{Ba}$  to the sample, two problems might arise when it is used sequential precipitation of  $(\text{Ba-Ra})\text{SO}_4$  and  $\text{PbSO}_4$  in the determination.

On one hand, there is a constant debate about the use of barium, stable or radioactive, to replicate  $^{226}\text{Ra}$  behaviour [9,10]; the argument to put forward is that barium and radium do not always behave identically. For this reason, the suitability of  $^{133}\text{Ba}$  as internal tracer for samples with phosphogypsum is evaluated. Sediments affected by NORM discharges have been measured and  $^{226}\text{Ra}$  activity concentration is obtained by means of LSC and gamma spectrometry, results are presented in Figure 2. Both values are in very good agreement within the uncertainty and the use of barium might be justified in this matrix.

Finally, regarding sequential  $^{210}\text{Pb}$  and  $^{226}\text{Ra}$  measurements, it is important to evaluate if  $^{226}\text{Ra}$  is totally removed from solution in the form of  $\text{RaSO}_4$  and do not interfere in  $^{210}\text{Pb}$  measurement. Furthermore, verify that none of the  $^{133}\text{Ba}$  added as a tracer is transferred to  $\text{PbSO}_4$  precipitate is a key step, as  $^{133}\text{Ba}$  is electrons emitter and the spectrum will be located in the same window that  $^{210}\text{Pb}$  spectrum [3].

The interference of Ba-Ra in Pb spectrum is checked by gamma-ray spectrometry and Cerenkov counting as alternative techniques (Figure 3). In addition, the stable barium found in  $\text{PbSO}_4$  precipitate is measured through ICP-MS. The results are shown in Table 1. The traces of Ba detected are less than 0.5% in all cases. Moreover,  $^{226}\text{Ra}$  concentrations measured through the different techniques are equal within the uncertainty.



#### 4. Conclusions

Sequential measurement of  $^{226}\text{Ra}$  and  $^{210}\text{Pb}$  through LSC, applying the sulphate precipitation method, it is suitable for samples affected by phosphogypsum discharges. Several factors must be taken into account; first of all, it is possible to evaluate the recovery measuring the final mass of the precipitate, however, this method works better for  $^{210}\text{Pb}$  evaluation than for that of  $^{226}\text{Ra}$ .

In the matrices presented in this work,  $^{133}\text{Ba}$  can be used as internal tracer for the evaluation of  $^{226}\text{Ra}$  recovery, in spite that barium and radium are not chemically the same. Moreover, no traces of interferences of  $^{133}\text{Ba}$  or  $^{226}\text{Ra}$  are found in the final lead sulphate precipitate.

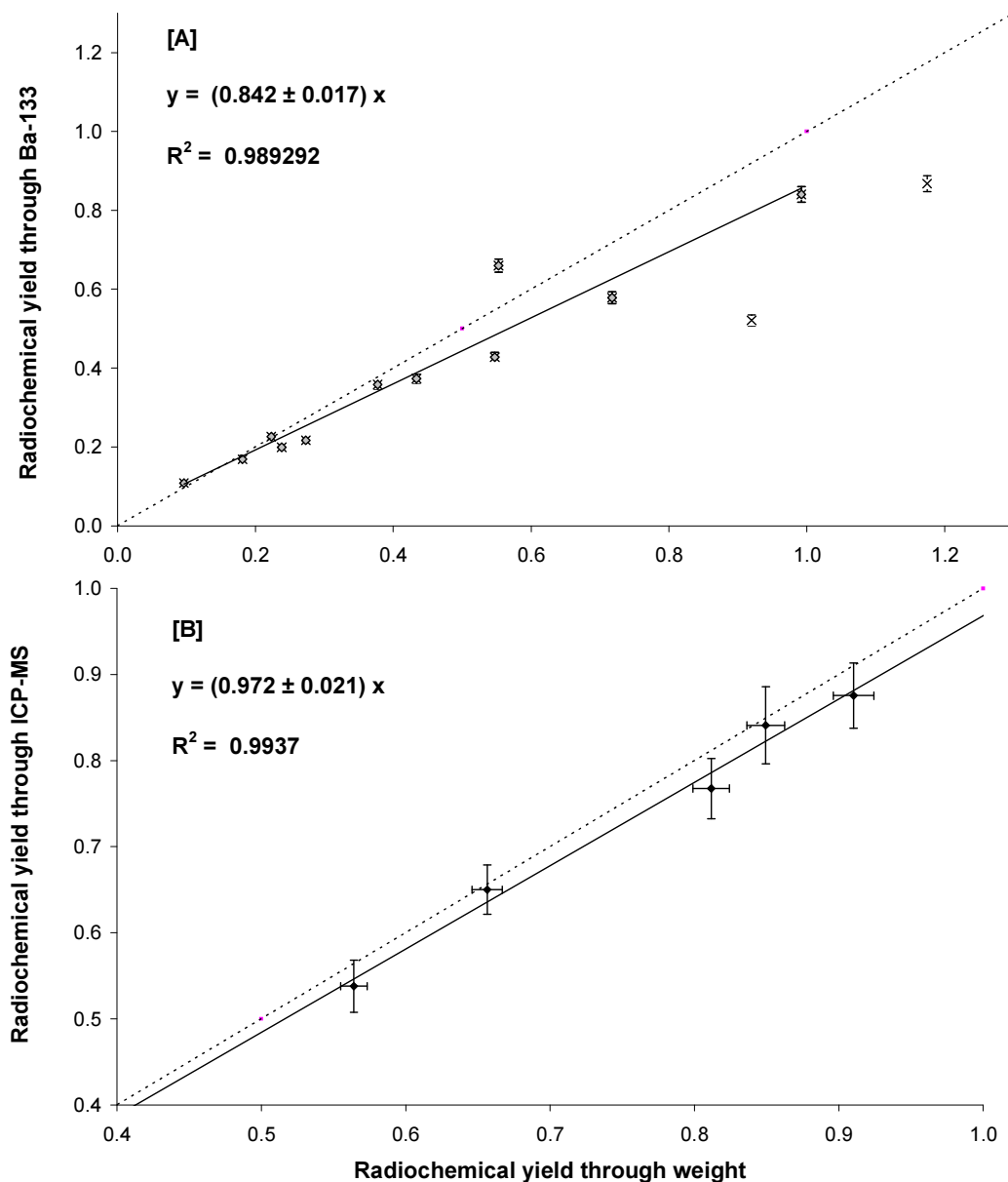

FIG 1. Radiochemical yield calculated through mass measurement vs radiochemical yield evaluated using two alternative methods: [A]  $^{133}\text{Ba}$  as internal tracer for  $^{226}\text{Ra}$  measurement (top) [B] ICP-MS to evaluate stable lead for  $^{210}\text{Pb}$ . Data are fitted to a linear function. Dashed lines corresponds to 1:1 relationship

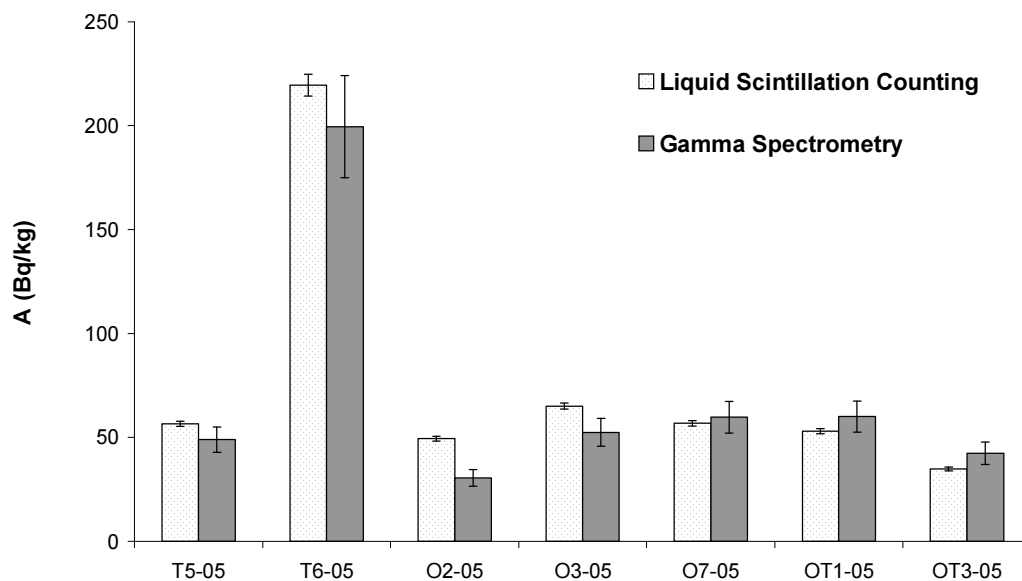

FIG 2.  $^{226}\text{Ra}$  activity concentration in sediment samples collected in Huelva estuary affected by phosphogypsum discharges through LSC. Radiochemical yield is obtained using  $^{133}\text{Ba}$  as internal tracer. Gamma measurement of the same samples is also presented. Uncertainty corresponds to one sigma

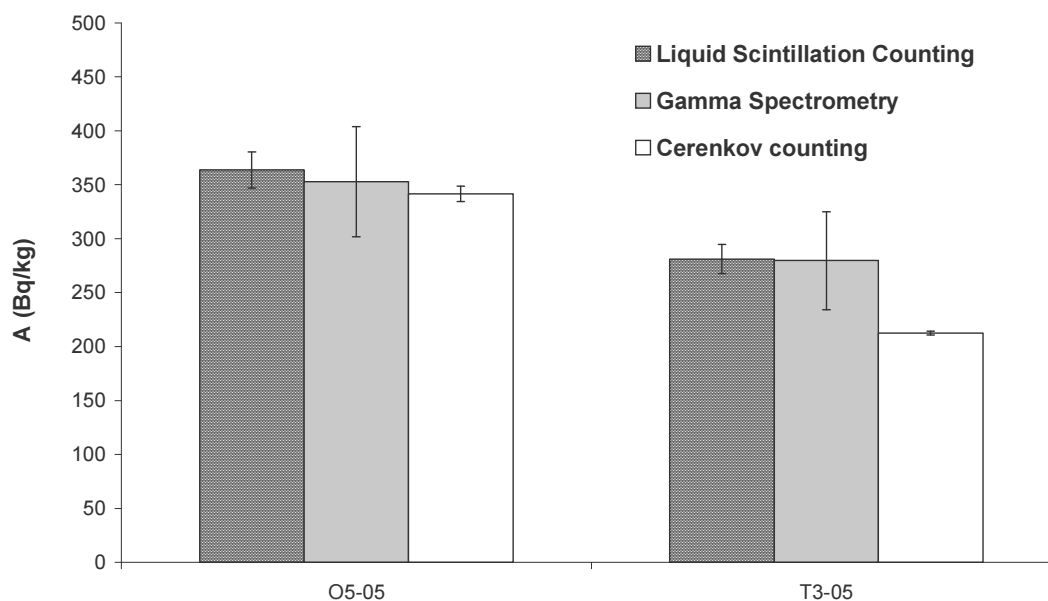

FIG 3.  $^{210}\text{Pb}$  activity concentration in sediment samples collected in Huelva estuary affected by phosphogypsum discharges through LSC and Cerenkov counting after the sulphate precipitation sequential method. Radiochemical yields used for Cerenkov and LSC determinations are obtained through the weigh of the sulphate precipitation. Gamma measurements are also presented. Uncertainty corresponds to one sigma.

TABLE 1. RADIOCHEMICAL YIELD OF STABLE BARIUM IN PbSO<sub>4</sub> PRECIPITATE MEASURED THROUGH ICP-MS AFTER THE PRECIPITATE IS DISSOLVED USING EDTA

ID	Yield of stable Barium in PbSO <sub>4</sub> precipitate (%)	
		±□
T3	0.048	0.003
O6	0.052	0.003
O7	0.270	0.028
OT1	0.341	0.004
O2	0.124	0.004
O3	0.144	0.010
T6	0.449	0.023
O7	0.255	0.001

### REFERENCES

- [1] ABSI, A., VILLA, M., MORENO, H. P., MANJÓN, G., PERIAÑEZ, R.. “Self-cleaning in an estuarine area formerly affected by <sup>226</sup>Ra anthropogenic enhancement. *Sci. Total. Environ.* 329” (2004) 183-195.
- [2] VILLA, M., HURTADO, S., MANJÓN, G., GARCÍA-TENORIO, R., GARCÍA-LEÓN, M.. “Direct <sup>210</sup>Pb determination in environmental samples by liquid scintillation counting and its validation through gamma-ray spectrometry”. Accepted for publication In: *Advances in Liquid Scintillation Spectrometry LSC 2005*. Internacional Radiocarbon, University of Arizona, Tucson, Arizona (2006).
- [3] VILLA, M., MORENO, H.P. Y MANJÓN, G. “Determination of <sup>226</sup>Ra and <sup>224</sup>Ra Activity Concentration by Liquid Scintillation Counting in Sediment Samples”. *Radiation Measurements* 39/5 (2005) 543-550.
- [4] LEBECKA, J., MIELNIKOW, A., CHALUPNIK, S., SKUBACZ, K.”Liquid scintillation counting of <sup>210</sup>Pb in grass and soil”. In: Noakes, J. E., Shönhofer, F., Polach., H. A., (Eds.), *Liquid Scintillation Spectrometry 1992*, Radiocarbon, Tucson, Arizona, (1993) 455-459.
- [5] KIM, Y., KIM, C, LEE, J.”Simultaneous determination of <sup>226</sup>Ra and <sup>210</sup>Pb in groundwater and soil samples by using the liquid scintillation counter – suspension gel method”. *Appl. Radiat. Isot.* 54 (2001) 275-281.
- [6] HURTADO, S., GARCÍA-LEÓN, M., GARCÍA-TENORIO, R. “<sup>210</sup>Pb determination in lead shields for low-level small gamma, □-spectrometry applying two independent radiometric techniques”. *Nucl. Instrum. Meth. A* 497 (2004) 381-388.
- [7] MOSQUEDA, F., VACA, F., VILLA, M., MANJÓN, G. “Optimization of the channel ratio method for the color quenching correction in the measurement of <sup>90</sup>Sr for Cerenkov counting”. Accepted for publication In: *Advances in Liquid Scintillation Spectrometry LSC 2005*. Internacional Radiocarbon, University of Arizona, Tucson, Arizona (2006).
- [8] CHALUPNIK, S., MIELNIKOW, A., SKUBACZ, K. “Fast method of <sup>226</sup>Ra measurement by means of alpha spectroscopy and its comparison with liquid scintillation counting”. In Möbius, S., Noakes, J., Shönhofer, F. (Eds.). *Advances in Liquid Scintillation Spectrometry, LSC 2001.* , Radiocarbon, Tucson, Arizona (2002) 261-267.
- [9] CHALUPNIK, S., LEBECKA, J., MIELNIKOW, A., MICHLIK, B. “Liquid Determination of radium in water”. In Cook, G. T., Harkness, D. D., McKenzie, A. B., Miller, B. F. y Scott, E. M. (Eds.). *Liquid Scintillation Spectrometry 1994.*, Radiocarbon (1993) 103-109.
- [10] IRLWECK, K. AND WALLNER, G. “Determination of <sup>226</sup>Ra in lake sediments by Liquid Scintillation Counting of cocktail-extracted <sup>222</sup>Rn”. *Liquid scintillation counting of <sup>210</sup>Pb in grass and soil*. In: Noakes, J. E., Shönhofer, F., Polach., H. A., (Eds.), *Liquid Scintillation Spectrometry 1992*, Radiocarbon, Tucson, Arizona (1993) 455-459.

# Development of a radon-aerosol system for testing radon and radon decay products measuring instruments

M. Calamosca<sup>a</sup>, S. Penzo<sup>a</sup>, A.O. Mustapha<sup>b</sup>

<sup>a</sup>ENEA-BAS-ION-IRP,  
Montecuccolino, Via dei Colli 16,  
40136 Bologna  
Italy

<sup>b</sup>Department of Physics,  
University of Nairobi,  
P.O. Box 30197, Nairobi,  
Kenya

**Abstract.** Exposures to radon and its decay products may arise from NORM-related work activities. Employers are responsible for monitoring radon in their workplaces, and the methods and instruments used must be subjected to adequate quality assurance. A radon chamber is an important component of a quality assurance programme. In this study we developed a radon-aerosol chamber and used it to characterise the prototype version of a newly developed radon decay product measuring instrument. The system comprises a small radon chamber with dry radon source, aerosol chamber, monodisperse aerosol generator, and TSI aerodynamic particle sizer with its accessories. Radon-laden air mixed with aerosols is pumped from the radon-aerosol system through the radon decay product measuring instrument. The instrument's response is obtained continuously from alpha spectrometric analyses of the radon decay products, <sup>218</sup>Po and <sup>214</sup>Po, deposited on a membrane filter (0.8 µm pore sizes and 25 mm diameter) held close to a silicon surface barrier detector. A second couple of filter and detector is inserted downstream to check the efficiency and eventual leakage of the membrane filter. The results show that alpha activity on the filter nearer to the inlet was significantly higher than the activity on the second filter. There were also significant losses of aerosols to the inner wall of the instrument as air flows through. The implications of these observations on the response of the instrument are discussed.

## 1. Introduction

Radon is the most important source of radiation exposure to the general public [1]. It is also a health risk in workplaces like underground mines, spas, waterworks, and industrial processing activities, where naturally occurring radioactive materials (NORM) are present [2,3]. According to available guidance and recommendations [2,4,5] on the protection of workers against radon exposures, these workplaces are to be surveyed with the appropriate equipments. The procedures and the equipment employed in the survey must undergo approved quality assurance (QA) programmes [5]. Calibration and routine qualification tests in reference radon chambers are important aspects of the QA programmes, as outlined in the international standards on radiation protection instrumentation [6].

The radon measurement service at the IRP-ENEA (Bologna) is developing a walk-in type radon chamber that meets internationally accredited standards [6,7]. As part of this ambitious project, a number of accessory instruments have been acquired, including the monodisperse aerosol generator, the aerodynamic particle sizer (APS-TSI), radon and radon decay products (RDP) monitoring instruments, etc. The service also owns a smaller radon chamber, which has been used in the past for in-house routine exposure tests of the CR-39 alpha track detectors. In the present work we used the instruments listed above in conjunction with the small radon chamber and an aerosol chamber to study the behaviour of a new RDP monitoring instrument, particularly to qualitatively check whether aerosol losses occur at the filters and whether aerosol deposition also occur elsewhere along the path of air flow. The test has enabled a better understanding of the behaviour of the RDP monitor.

## 2. Materials and methods

### 2.1. The aerosol generator

A condensation monodisperse aerosol generator (MAGE) is used to produce the aerosols of desired concentration and size. Condensation nuclei are produced by the atomization in a Collision generator of

dilute solution (20 mg/liter) of NaCl and bubbled (in a stream of pure nitrogen gas) through vapourized carnauba wax. The vapourized carnauba wax condenses on the NaCl nuclei to produce monodisperse aerosols with median diameter ranging from 0.22 to 2.2  $\mu\text{m}$  and geometric standard deviation of around 1.1. Detailed description of the features and operation of MAGE is given by Prodi [8].

## ***2.2. The aerosol chamber***

The aerosol chamber is a cube of 97 l made from transparent Perspex sheet. Stream of aerosols from the reheat column of the generator is fed directly into the chamber through a valve. On entering the chamber, the aerosols disperse quickly throughout the volume. The chamber is fitted with motorised fans for mixing and circulation purposes.

## ***2.3. The radon chamber***

The radon chamber consists of two parts; a cylindrical steel containing the radon source, which is crushed uranium bearing mineral-ore spread thinly inside a Mylar bag to selectively prevent thoron exhalation, and a Teflon box of inner dimensions 24.6 cm x 37.4 cm x 19.0 cm - about 17.4 l in volume. The two compartments are connected through a valve. When not in use the valve is closed and radon from the mineral-ore accumulates in the steel container. Radon gas measuring devices and other accessories are either enclosed in the Teflon box or connected inline with it through the available valves. When the need arises the Teflon box can also be emptied quickly by flushing with nitrogen gas.

## ***2.4. The aerodynamic particle sizer***

The aerosol particle aerodynamic diameter is measured using the TSI aerodynamic particle sizer (APS) model 3300. It measures the particles aerodynamic diameter in real-time. During the test it has been used connected to a TSI model 3302 Diluter for reducing the concentration of aerosols in the air before reaching the APS. Details of the operations of the APS and its accessories are given in the TSI Model APS 3300 user manual [9].

## ***2.5. The RDP monitor***

The RDP monitor tested is a prototype developed at the IRP-ENEA. It can be used as a working level meter or for monitoring of the ambient air. An external pump is used to draw radon-laden air at 7.4 l/min through micro-orifices and across 0.8  $\mu\text{m}$  membrane filters, which retain the particles. The alpha particles emitted by the radon decay products retained on the filter are detected by a surface barrier detector installed directly opposite the filter and connected to a PC controlled alpha spectrometer. The monitor can operate with two sets of the filter-Silicon barrier detector (SBD) parts in cascade. During sampling the two detectors are maintained at different pressures. There is the flexibility to chose between two-stage operation (i.e. with the two sets of filter-SBD) or one-stage.

## ***2.6. Generating and characterising the aerosols***

The schematic diagram of the radon-aerosol system is shown in Figure 1. Aerosols were produced using the MAGE. The size of the aerosols produced was varied by changing the re-heat temperature. Aerosols of the desirable size were injected into the aerosol chamber. Grab samples of the aerosol were drawn from the chamber into the APS through the diluter to reduce the aerosol concentration 100 times before getting into the APS's nozzles so as to prevent clogging the nozzles and the filters. The total flow, sheath flow and pressure transducer values were set, and the aerosol count median aerodynamic diameters (CMAD) were determined as described in the user manual [9]. Using the volume of the aerosol chamber and the aerosol generating rate of the MAGE, the time required to fill the aerosol chamber was estimated to be 25 minutes.

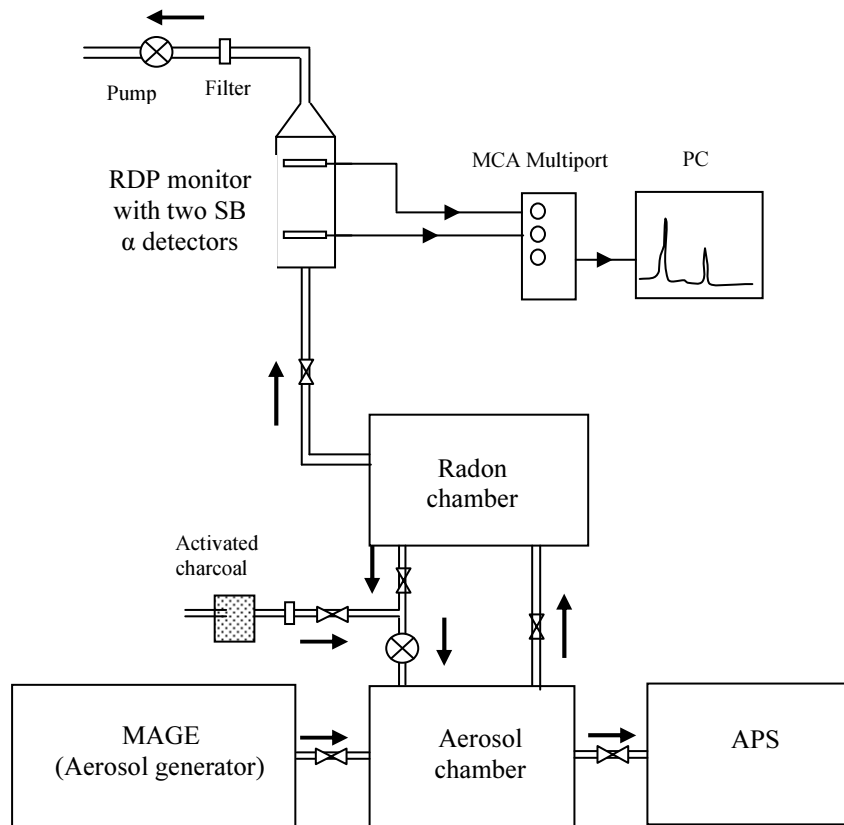

FIG. 1. Schematic diagram of the radon-aerosol system.

### 2.7. Mixing radon and aerosols

The flow circuit between the radon chamber and the aerosol chamber was completed by switching on the connecting valves and the pump. The contents of the two chambers were circulated for about 30 minutes: this time allows to get an aerosol concentration inside the radon chamber equivalent to the 10 % of the aerosol chamber concentration.

### 2.8. Sampling with the RDP monitor

The sampling and analyses components are shown on the upper half of the circuit in Figure 1. Air from the radon chamber was drawn through the RDP monitor for 30 minutes. The working pressures at the two filters resulted respectively 460 and 300 mm Hg, due to the losses of head at the critical nozzles and at the first filter. During the 30 minutes sampling period the alphas produced by the short-lived RDP ( $^{218}\text{Po}$  and  $^{214}\text{Po}$ ) deposited on the filters were counted and analysed in real time with the Genie 2000 spectroscopy.

## 2.9. Gamma spectrometric analysis

The RDP monitor consists of detachable parts coupled together. If there are deposits of aerosols within the inner surface of the monitor they are measurable by gamma-ray spectrometry of  $^{214}\text{Pb}$  (26.8 min) or its decay product  $^{214}\text{Bi}$  (19.9 min) after the end of the sampling. Therefore after the alpha spectrometric measurements, the RDP monitor was dismantled and the components were individually subjected to gamma-ray spectrometric analysis in a large (8") scintillation (NaI(Tl)) well detector. The counting efficiencies were performed by counting a standard planar  $^{226}\text{Ra}$  gamma source in the appropriate geometries.



FIG. 2. RPD monitor components investigated for the losses assessment

TABLE 1. RADIOISOTOPE EFFICIENCIES USED IN THE GAMMA RAY SPECTROMETRIC ANALYSIS OF THE 4 RDP MONITOR COMPONENTS.

Monitor component	$^{214}\text{Bi}$ activity efficiency	$^{214}\text{Pb}$ activity efficiency
Main body	$8.2 \pm 1.0 \%$	$8.0 \pm 1.0 \%$
Critical nozzles	$10.0 \pm 1.3 \%$	$53.3 \pm 6.3 \%$
Sampling port section	$8.0 \pm 1.0 \%$	$48.2 \pm 5.7\%$
Conical PIP holder	$9.6 \pm 1.3 \%$	$43.5 \pm 5.1 \%$

## 3. Results and discussion

### 3.1. Aerosol size distribution

The CMAD of the aerosols for MAGE oven temperatures ranging from 200°C to 250°C is comprised between 0.6 and 1.1  $\mu\text{m}$ . The CMAD of the aerosols used for the test is 1.1  $\mu\text{m}$  with a  $S_g=1.1$ . Two independent tests confirmed that the aerosols produced in these temperature range were monodisperse. First, the aerosol column displayed sharp higher order Tyndall colours when illuminated with a collimated white light beam as described by Prodi [8]. Secondly, samples of the aerosols deposited on slides have uniform dimensions when viewed under high magnification of optical microscope.

### 3.2. Aerosol retention on filters

The activity on the first filter is very high and the alpha spectrum (Figure 2) is dominated by the contributions from  $^{218}\text{Po}$  and  $^{214}\text{Po}$ . On the other hand the activity on the second filter is close to background (Figure 3). Comparing the two spectra there is an apparent shift in the channel numbers corresponding to the peaks of  $^{218}\text{Po}$  and  $^{214}\text{Po}$ , due to the different working pressures, as stated before. Qualitatively, the aerosol loss around the 25 mm diameter and 0.8  $\mu\text{m}$  pore size membrane filter is negligibly at the specified pressure drop, flow rate and aerosol diameter. Virtually all the particles were effectively retained on the first filter; the presence of the negligible radioactivity on the second filter could be related to the decay of  $^{222}\text{Rn}$  during the flight from the first to second filter. In this regard the filter's performance is satisfactory and the role of the second filter in this monitor is therefore not very important.

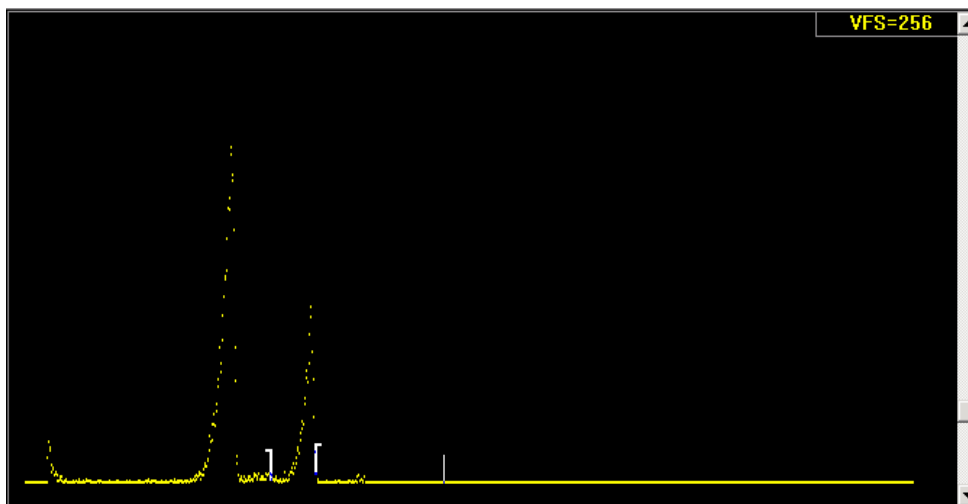

FIG. 3. Alpha spectrum of aerosols on filter 1 accumulated for 30 minutes during sampling

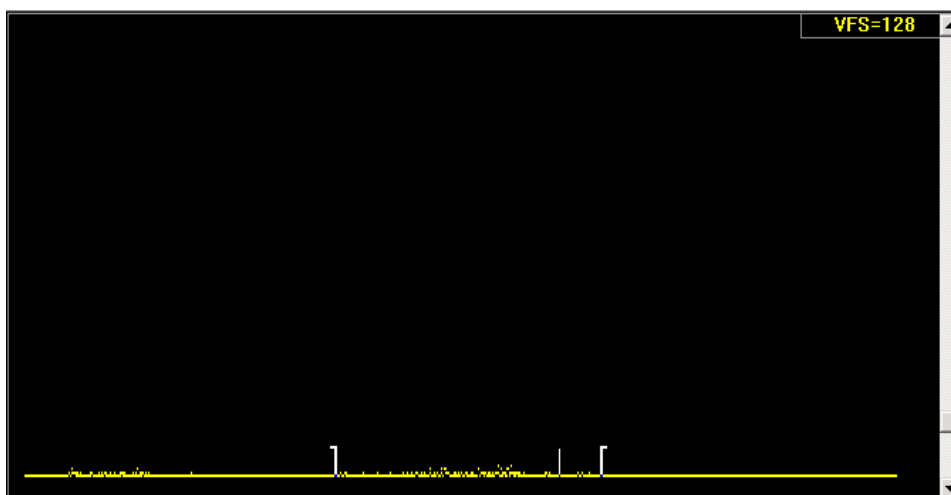

FIG. 4. Alpha spectrum of aerosols on filter 2 accumulated for 30 minutes during sampling

At the end of RnPD sampling, the  $^{218}\text{Po}$  and  $^{214}\text{Po}$  filter activities, resulted respectively about 54 Bq and 28 Bq. The  $^{214}\text{Po}$  activity is the same of the  $^{214}\text{Bi}$  activity, and it will be used to compare the amount of losses due to the deposition of aerosols along the monitor.



### 3.3. Deposition of aerosols along the monitor's inner surfaces

The following procedure to determine the percent losses in the different counted RDP monitor components was adopted:

1. from the mean  $^{214}\text{Bi}$  activity determined in the course of counting, the activity at the beginning of the counting time is assessed.
2. The contribution to the  $^{214}\text{Bi}$  activity due to the decay of the sole  $^{214}\text{Pb}$  during the period from the end of sampling to the beginning of counting was subtracted from 1.
3. The  $^{214}\text{Bi}$  activity at the end of sampling is determined by correcting for the decay the net  $^{214}\text{Bi}$  activity at the start of counting time.
4. The total  $^{214}\text{Bi}$  activity at the end of sampling is evaluated by summing the 4 component activities and the filter activity (see Table 2).
5. The ratio of the  $^{214}\text{Bi}$  activity of the component and total activity determines the loss.

The results of the analysis are shown in table 2. The test to determine where, the aerosols deposit along RDP monitor before entering the filter, revealed that most of the aerosol losses occurred at the critical nozzles, and, of less importance, around the conical SBD (PIP) holder. Some minor losses also occurred at the other components. The RPD monitor effective efficiency reduced to 32% with aerosol CMAD 1.1  $\mu\text{m}$ . Uncertainties were not specified because this test is preliminary and then primarily qualitative. A quantitative determination of the ratios of aerosol deposit on the filter to the quantity deposited on the other parts will require a different timetable of sampling and counting, as for instance suggested by Tremblay [10]. The dependence of the fractional deposition of aerosols on the filters and the other parts of the instrument on the aerosol particles sizes will also be investigated.

TABLE 2. RESULTS OF THE RDP MONITOR COMPONENTS AEROSOL DEPOSITION BASED ON THE SPECTROMETRIC ANALYSIS  $^{214}\text{Bi}$ .

The filter activity is obtained by the alpha  $^{214}\text{Po}$  spectrometry.

RDP monitor component	Activity [Bq] At the end of sampling	Percent deposition [%]
Filter	28	32
Main body	4	4
Critical nozzles	42	48
Sampling port section	4	5
Conical PIP holder	10	11

### 4. Conclusion

Tests were carried out to investigate if aerosol losses occur and where they occur in the RDP monitor when it is in use. The importance of a radon chamber in carrying out these tests was emphasized and the procedures as well as the accessory equipments were described. The tests revealed that loss of the aerosols of about 1  $\mu\text{m}$  CMAD through the filter is minimum. However, the results also show that depletion of aerosol from the air flow occur and most of the depleted aerosols were deposited on the inlet critical nozzles. Further investigations are planned to determine the dependence of aerosol losses and aerosol enrichment along the wall of the monitor on the aerodynamic diameter of the aerosol. The ratio of aerosol retention on the filters to those deposited elsewhere along the body of the monitor is also required to fully characterise the monitor. The walk-in type radon chamber that is being developed by the radon measurement service at the IRP-ENEA will go a long way in facilitating these studies.

## REFERENCES

- [1] UNITED NATIONS SCIENTIFIC COMMITTEE ON EFFECTS OF ATOMIC RADIATION Dose assessment methodologies UNSCEAR Report to the general assembly, New York, (2000).
- [2] INTERNATIONAL ATOMIC ENERGY AGENCY, Radiation protection against radon in workplaces other than mines, Safety reports series No. 33 International Atomic Energy Agency, Vienna (2003).
- [3] Van der Steen, J. and Van Weers, A.W. Radiation protection in NORM industries 11<sup>th</sup> International congress of the international radiation protection association IRPA11, 23-28 May 2004, Madrid, Spain, (2004).
- [4] INTERNATIONAL COMMISSION ON RADIOLOGICAL PROTECTION, Protection against Radon-222 at home and at work, Publication 65, Pergamon Press, Oxford (1993).
- [5] EUROPEAN COMMISSION, Recommendations for the implementation of Title VII of the European Basic Safety Standards Directive (BSS) concerning significant increase in exposure due to natural radiation sources. Radiation protection 88, (1997).
- [6] INTERNATIONAL ELECTROTECHNICAL COMMISSION, Radiation Protection Instrumentation – Radon and radon decay product measuring instruments – Part1: General principles, final draft IEC 61577-1 Ed.2, (2006).
- [7] NATIONAL RADON SAFETY BOARD (NRSB) Radon chamber accreditation (2006), <http://www.nrsb.org/about%20Chambers.htm>
- [8] Prodi V. A condensation aerosol generator for solid monodisperse particles. pp. 169-179 in Assessment of airborne particles., Mercer, T.T., Morrow, P.E. and Stober, W. Ed. C.C. Thomas Publ., (1987).
- [9] TSI Aerodynamic particle size analyzer 3300, Instruction manual TSI Inc., St. Paul, MN, (1983).
- [10] Tremblay, R.J., Leclerc, A., Mathieu, C, Pepin, R. and Townsend, M.G. Measurement of radon progeny concentration in air by  $\alpha$ -particle spectrometric counting during and after air sampling. Health Phys. Vol.36, pp. 401-411, (1979).

# Estimation of the radiological risk related to the presence of radon $^{222}\text{Rn}$ in a hydrotherapy centre of Tunisia

F. Essafi <sup>a1</sup>, S. Labidi <sup>b</sup>, H. Mahjoubi<sup>b</sup>

<sup>a</sup> Faculty of Medicine of Tunis, section of Biophysics.

<sup>b</sup> Institut Supérieur des Technologies Médicales de Tunis (ISTMT).

**Abstract.** The  $^{222}\text{Rn}$  concentration in air was measured in a thermal water spa used as a hydrotherapy centre in Tunisia. The associated health risk for employees and patients due to the inhalation of  $^{222}\text{Rn}$  and its progeny was estimated. A protection scheme for the employees of the spas has been designed.

Results show that the  $^{222}\text{Rn}$  concentration varies in the range [33-589]  $\text{Bq}\cdot\text{m}^{-3}$ . The  $^{222}\text{Rn}$  concentrations measured in the present study show lower values in comparison to those reported for the thermal spas of other countries. The  $^{222}\text{Rn}$  concentration in different rooms of the spa depends mainly on the ventilation rate. A model based on dosimetric approach was adopted to estimate radon risk considering the  $^{222}\text{Rn}$  concentration, the time spent in the spa, and the radioactive equilibrium factor F. The annual effective dose was found varying between 0.2 and 1.7 mSv for workers while the range for patients was from  $2.8 \cdot 10^{-4}$  to  $110 \cdot 10^{-4}$  mSv. These values are within the ICRP recommended value.

## 1. Introduction

Hydrotherapy is a form of medication using natural hot water from underground or some of its derivative products such as steam, gas and mud. The underground water contains higher concentrations of  $^{222}\text{Rn}$ . When thermal waters reach the surface inside the spa, the  $^{222}\text{Rn}$  passes into air inducing its accumulation inside the treatment rooms of the thermal establishment [1], [2]. The poor ventilation in the confined space of the spa induces the higher concentration of  $^{222}\text{Rn}$  inside the treatment rooms.

Therefore, the aim of this study is:

- To estimate the radon risk for the employees and the patients in a hydrotherapy spas in Tunisia.
- To establish, if necessary, a protection scheme for workers in this spa.

## 2. Experimental methods

### 2.1. Thermal spas in Tunisia

There are three thermal spas in Tunisia. The first is located in Hammam Bourguiba which is 100 km North West of Tunis whose specificity is the treatment of the upper respiratory tract. The second thermal spa is at Korbous located in the north east of Tunisia 50 km from Tunis. The third spa is located in Jebel Ouest which is situated 38 km south west of Tunis. This hydrotherapy centre is supplied by only one thermal water source: the Jebel Ouest source. The thermal water is picked up in a natural cave situated at the bottom of a 105 m-long mine gallery.

Since the concentration of  $^{222}\text{Rn}$  depends on the concentration of  $^{226}\text{Ra}$ , a preliminary study was carried out in all thermal establishments of Tunisia to determine the  $^{226}\text{Ra}$  content of the thermal waters. The methods employed for the measurements of  $^{222}\text{Rn}$  and  $^{226}\text{Ra}$  are presented and discussed below.

---

<sup>1</sup>Present address: Faculty of Medicine of Tunis, section of Biophysics,  
15, Rue Djebel Lakhthar, 1006 (B.S), Tunis. TUNISIA. E.Mail : essafi\_fatma@yahoo.fr

## 2.2. Determination of $^{226}\text{Ra}$ concentration

The  $^{226}\text{Ra}$  present in the water samples was concentrated and separated by barium sulfate co-precipitation method [3], and then the activity of radium was determined by gamma spectrometry. Twenty liters of water samples were collected in polyethylene bottles with screw caps and immediately acidified to  $\text{pH} \approx 2$  with concentrated  $\text{HNO}_3$ . At the end of the radiochemical separation the powder containing  $^{226}\text{Ra}$  was sealed into a plastic ferrule whose form is compatible with the dimensions of the well type germanium detector used. The samples were stored for minimum of 20 days to allow  $^{226}\text{Ra}$  to come into equilibrium with its daughters.

A  $220 \text{ cm}^3$  low-background well type gamma ray detector was employed for the measurement of  $^{226}\text{Ra}$ . The measurements were made in the underground Laboratory of Modane in France (LSM - Centre National de la Recherche Scientifique/Commissariat à l'Energie Atomique, France).

The efficiency of  $^{226}\text{Ra}$  extraction by  $\text{BaSO}_4$  precipitation was obtained by calculating the weight ratio of recovered  $\text{BaSO}_4$  to introduced  $\text{BaCO}_3$ .

A correcting mass factor of 1.16 was used for the calculation.

The extraction efficiencies were found to vary in the range of [75% - 100 %].

## 2.3. Determination of $^{222}\text{Rn}$ concentration

A passive method was employed for the measurement of  $^{222}\text{Rn}$  concentrations in air inside the thermal spa [4]. A solid state nuclear tracks detector, Kodalpha open alpha-track devices (Dosirad, Paris, France), was used in the present study. After the exposure the detectors were etched and the tracks were counted by means of an automatic optical reader. From the total number of tracks obtained the  $^{222}\text{Rn}$  concentration was calculated. A total of 24 dosimeters were fixed to the wall 1.5 m above the floor level in different treatment rooms of the thermal spa. The detectors were exposed for 60 days inside different rooms of the thermal spa. In each room two dosimeters were exposed and the average value is taken as the representative value. The minimum detection limit for used dosimeters was found to be  $5 \text{ kBq}\cdot\text{h}^{-1}\cdot\text{m}^{-3}$ .

## 3. Experimental results

### 3.1. Radium concentration measured in the water sources

The results of  $^{226}\text{Ra}$  concentration measurement in thermal water sources for the three spas in Tunisia are presented in Table I.

TABLE I. REGISTERED CONCENTRATIONS OF  $^{226}\text{Ra}$  IN THERMAL SPAS OF TUNISIA

State	Thermal waters Source	$^{226}\text{Ra}$ (mBq/L)	Normalized activity of $^{226}\text{Ra}$
Jendouba (H.Bourguiba)	High Source	157	3.84 %
	Popular Source	220	5.38 %
	Low lying Source.	200	4.89 %
Nabeul (Korbous)	Aïn Echfa	749	18.32 %
	Aïn El Atrous	750	18.34 %
Zaghouan	Jebel Oust	4089	100 %

The highest concentration of  $^{226}\text{Ra}$  was found in the water source of Jebel Ouest spa, whereas the other two spas have lower concentrations ( $< 20\%$ ). That led us to investigate indoor radon concentrations within Jebel ouest spa.

### 3.2. Radon concentrations in Jebel Ouest spa

Table II shows the activity  $C_{\text{Rn}}$  ( $\text{Bq}\cdot\text{m}^{-3}$ ) of  $^{222}\text{Rn}$  measured in the different sites of the spa.

TABLE II. ACTIVITY OF  $^{222}\text{Rn}$  IN THE DIFFERENT CARE ROOMS OF THE SPA

	CARE ROOM	Activity of $^{222}\text{Rn}$ $C_{\text{Rn}}$ ( $\text{Bq}\cdot\text{m}^{-3}$ )
UNDER GROUND	Reception	76
	Steam-up therapy room	352
	Inhalation treatment room	313
	Mud application	333
	Shower-bath	58
	Bath room	75
	Under waters Massage	53
GROUND ZERO	Swimming pool	45
	Changing room	33
FIRST STAGE	Bath room	111
	Pediluvium & Maniluvium	91
	Shower-bath	143
OTHER	Mining (Gallery)	589

### 3.3. Discussion

Results show a large variation in the concentration of  $^{222}\text{Rn}$  in the spa. Inhomogeneous distribution of concentration was observed all over the treatment rooms of the spa.

The highest concentration of  $^{222}\text{Rn}$  observed in the mine gallery may be due to the proximity of the thermal water source and to the poor ventilation rate of this site. This area is not considered as a high risk one, because even the cleaning workers are the only staff working in the mining gallery, the time they spend in this site never exceeds 140 hours a year.  $^{222}\text{Rn}$  concentrations obtained in the treatment rooms situated in the basement are at a high level as a result of the reduced ventilation rate.

The dilution and rapid dispersing of  $^{222}\text{Rn}$  due to increased ventilation (by frequent opening of doors) in the swimming pool and in the changing rooms, explains the lowest concentration of Radon there (less than  $50 \text{ Bq}\cdot\text{m}^{-3}$ ).

The environment of the steam-up therapy room is hot, humid, with a high level of steam and without any ventilation. That may explain the high concentration of  $^{222}\text{Rn}$  ( $352 \text{ Bq}\cdot\text{m}^{-3}$ ) in this treatment room. Nevertheless, the difference between the  $^{222}\text{Rn}$  concentration in a treatment room and in the mining gallery may be due to physicochemical considerations occurring when transferring thermal water from the mining gallery to treatment rooms. Transfer of water from the thermal source to the different sites of the spa causes out-gassing of  $^{222}\text{Rn}$  thereby reducing its concentration in water. A similar trend was observed in some thermal spas of France [7], [8]. They have reported a decrease up to 80% in the concentration of  $^{222}\text{Rn}$  when the water is transferred from the thermal source to the bathrooms. The repartition of activities of  $^{222}\text{Rn}$  in the spa is illustrated in Fig. 1.

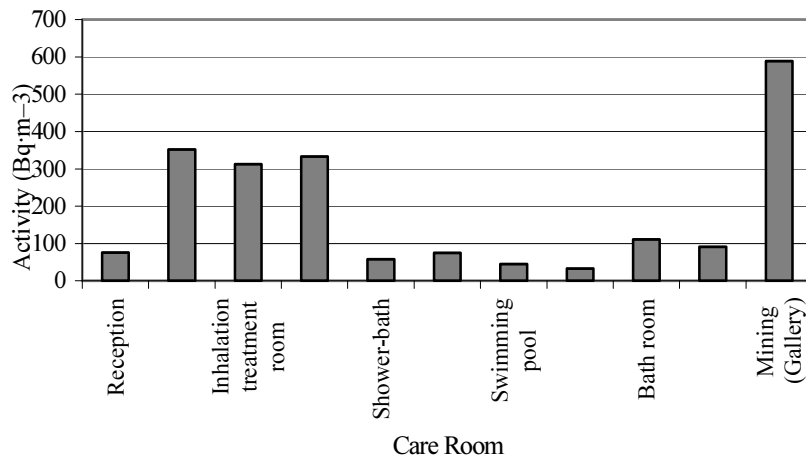

FIG. 1. Activity of <sup>222</sup>Rn in the different care rooms of the spa

Compared to the results reported for several spas of other countries in Table III, most of the sites of the Tunisian spa show lower concentrations of <sup>222</sup>Rn.

In the thermal station of Rudas, Hungary the <sup>222</sup>Rn concentrations in air were found to vary in the range [4,300-7,150] Bq·m<sup>-3</sup> [9]. This had been attributed to the continuous exhalation of <sup>222</sup>Rn due to the continuous filling up of baths. Also in the thermal spa of Las Caldas in Besaya of Spain, the <sup>222</sup>Rn concentration in the therapeutic bathrooms varied from 3,560 to 6,650 Bq·m<sup>-3</sup> [10]. In other Spanish thermal spas, the concentration in hydrotherapy rooms varies between 800 and 5,200 Bq·m<sup>-3</sup> [11]. The concentration range reported for Badgastein thermal complex of Austria is [850-3,300] Bq·m<sup>-3</sup> [12]. The mean value of <sup>222</sup>Rn concentration reported for the Japanese thermal spa of grotto of Misasa is 2,700 Bq·m<sup>-3</sup> [13].

TABLE III. COMPARATIVE VALUES BETWEEN SEVERAL COUNTRIES

Country	Spa	Concentration of <sup>222</sup> Rn (Bq·m <sup>-3</sup> )
TUNISIA	Jebel Ouest	[0 - 589]
SPAIN	Las Caldas in Besaya	[3,560 - 6,650]
HUNGARY	Rudas	[4,300 -7,150]
JAPAN	Grotto of Misasa	2,700
AUSTRIA	Badgastein complex	[850 - 3,300]

#### 4. Calculations and estimations

##### 4.1. Estimation of health risk due to inhalation of <sup>222</sup>Rn

The International Agency for Research on Cancer (IARC) of the World Health Organization (WHO) at Lyon (France) recognized in 1987 that inhalation of <sup>222</sup>Rn and its progeny may induce lung cancer in humans. The inhaled Potential Alpha Energy (PAE) is considered as an indicator of the risk. The short lived <sup>222</sup>Rn progeny emit alpha particles and contribute significantly to the inhalation dose. Apart from this, the short lived <sup>222</sup>Rn daughter products also emit beta particles (<sup>214</sup>Pb and <sup>214</sup>Bi) and

they also contribute to the internal exposure. However, biological effects of beta particles (by internal exposure), are negligible when compared to those of alpha particles and the risk is related only to Potential Alpha Energy Concentration (PAEC) [5].

When radioactive equilibrium occurs, activities of  $^{222}\text{Rn}$  and of its daughter products take the same value. Nevertheless, the short-lived daughter products of  $^{222}\text{Rn}$  may deposit on the walls or can be removed by air renewal systems and do not contribute towards internal exposure.

Thus radioactive equilibrium never exists and a correction factor F is necessary to take into account this disequilibrium. As recommended by ICRP [5],  $F= 0.4$  for calculations. PAEC is calculated using Equation (1):

$$\text{PAEC} = \text{PAE} \times C_{\text{Rn}} \times F \quad (1)$$

where

$C_{\text{Rn}}$  is the concentration of  $^{222}\text{Rn}$

F is the correction factor.

PAE =  $5.54 \times 10^{-9}$  J when 1 Bq of  $^{222}\text{Rn}$  is inhaled

#### 4.2. Exposure to $^{222}\text{Rn}$ and its progeny

The annual exposure to  $^{222}\text{Rn}$  for workers in the thermal spa depends primarily on the concentration of  $^{222}\text{Rn}$  exhaled in each site, on the ventilation rate of the room and also on the time spent in this environment [6].

Assuming that all workers spend maximum work time in the spa regardless of location, estimated work time is 36 hours a week and 11 months a year. That means 1,584 hours for each employee.

The patients, using spa as a cure, spend daily 5 to 20 minutes in each treatment room except in inhalation treatment rooms where they spend 45 minutes. The mean time spent in the spa is about 3 weeks a year for each patient.

The exposure  $\varepsilon$  due to the inhaled  $^{222}\text{Rn}$  and its decay products is related to PAEC and to the duration T of exposure:

$$\varepsilon = (\text{PAEC}) \times T \quad (2)$$

where

(PAEC) is the Potential Alpha Energy Concentration of  $^{226}\text{Rn}$

T is the duration of the exposure

#### 4.3. Effective dose due to the inhalation of $^{222}\text{Rn}$

As recognized by the ICRP the risk due to the inhalation of  $^{222}\text{Rn}$  can be estimated by the annual effective [5]. Recommended limits by ICRP are:

- 20 mSv for the workers
- 1 mSv for the public

Calculated annual exposures and effective doses received by workers and patients, in the different treatment rooms of the spa, are given in Table IV.

TABLE IV. CALCULATED POTENTIAL ALPHA ENERGY CONCENTRATION (PAEC), ANNUAL EXPOSURE ( $\epsilon$ ) AND ANNUAL EFFECTIVE DOSE (E) RECEIVED BY WORKERS AND PATIENTS IN THE SPA

	CARE ROOM	WORKERS				PATIENTS		
		PAEC ( $\text{J}\cdot\text{m}^{-3}$ )	Time Spent (h/a)	$\epsilon$ ( $\text{J}\cdot\text{s}\cdot\text{m}^{-3}$ )	E (mSv)	Time spent (min/day)	$\epsilon$ ( $\text{J}\cdot\text{s}\cdot\text{m}^{-3}$ )	E (mSv)
UNDER GROUND	Reception	$168 \cdot 10^{-9}$	1,584	0.94	0.4	5	$9.36 \cdot 10^{-4}$	$2.8 \cdot 10^{-4}$
	Steam-up therapy room	$780 \cdot 10^{-9}$	----	----	----	10	$86.4 \cdot 10^{-4}$	$26.0 \cdot 10^{-4}$
	Inhalation room	$694 \cdot 10^{-9}$	1,584	3.96	1.6	45	$338.40 \cdot 10^{-4}$	$110.010^{-4}$
	Mud Application	$738 \cdot 10^{-9}$	1,584	4.21	1.7	5	$39.60 \cdot 10^{-4}$	$12.010^{-4}$
	Shower-bath	$129 \cdot 10^{-9}$	1,584	0.74	0.3	10	$14.04 \cdot 10^{-4}$	$4.3 \cdot 10^{-4}$
	Bath room	$166 \cdot 10^{-9}$	1,584	0.95	0.4	15	$27.00 \cdot 10^{-4}$	$8.3 \cdot 10^{-4}$
	Under waters Massage	$117 \cdot 10^{-9}$	1,584	0.67	0.3	10	$12.60 \cdot 10^{-4}$	$3.9 \cdot 10^{-4}$
GROUND ZERO	Swimming pool	$100 \cdot 10^{-9}$	1,584	0.57	0.3	20	$21.60 \cdot 10^{-4}$	$6.6 \cdot 10^{-4}$
	Changing room	$73 \cdot 10^{-9}$	1,584	0.42	0.15	20	$15.84 \cdot 10^{-4}$	$4.8 \cdot 10^{-4}$
FIRST STAGE	Bath room	$246 \cdot 10^{-9}$	1,584	1.40	0.6	15	$39.60 \cdot 10^{-4}$	$12.0 \cdot 10^{-4}$
	Pediluvium & Maniluvium	$202 \cdot 10^{-9}$	1,584	1.15	0.4	10	$21.96 \cdot 10^{-4}$	$6.7 \cdot 10^{-4}$
	Shower-bath	$317 \cdot 10^{-9}$	1,584	1.81	0.75	10	$34.20 \cdot 10^{-4}$	$11.0 \cdot 10^{-4}$
OTHER	Mining (Gallery)	$1,305 \cdot 10^{-9}$	140	0.66	0.3	----	----	----

#### 4.4. Discussion

Table IV shows that the calculated Potential Alpha Energy Concentration (PAEC) was ranged between  $73 \cdot 10^{-9}$  and  $780 \cdot 10^{-9} \text{J}\cdot\text{m}^{-3}$  while for mining it was evaluated to  $1,305 \cdot 10^{-9} \text{J}\cdot\text{m}^{-3}$ .

The annual exposure to  $^{222}\text{Rn}$  was found to be higher for workers 0.42 to  $3.96 \text{J}\cdot\text{s}\cdot\text{m}^{-3}$  when compared to values for patients  $9.36 \cdot 10^{-4}$  to  $338.40 \cdot 10^{-4} \text{J}\cdot\text{s}\cdot\text{m}^{-3}$ . The calculated annual effective dose varies from 0.15 to 1.7 mSv for workers and  $2.8 \cdot 10^{-4}$  to  $110.0 \cdot 10^{-4}$  mSv for patients (Table IV). Because of the longer time spent by the workers in each site of the thermal spa, patients receive the lowest



effective dose. All values of effective doses are much lower than the limits recommended by ICRP either for employees or for patients.

The inhalation treatment room presents the highest effective dose for both patients and workers. One can then consider the dose received in this room as 100%. Figure 2 shows these normalized effective dose values when reported to those obtained for the inhalation treatment room.

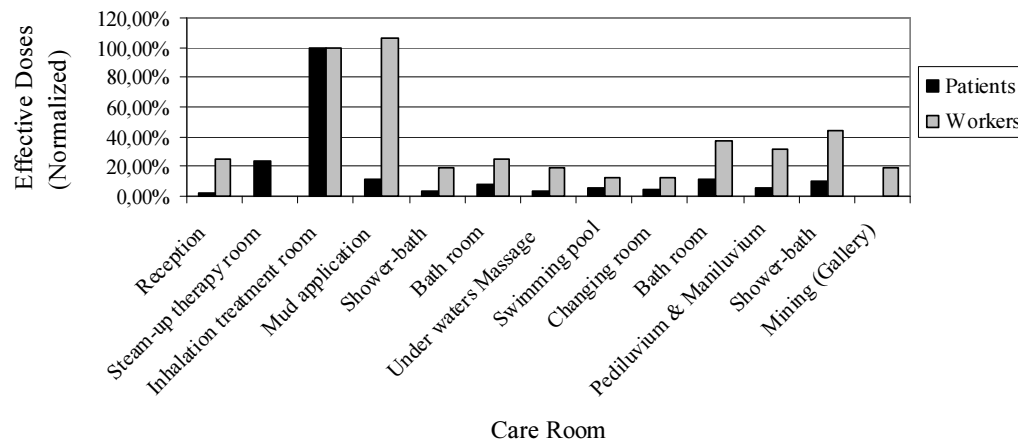

FIG. 2. Normalized effective doses due to  $^{222}\text{Rn}$  for workers and patients in the spa

This normalization deals with the main aim of this study which is to evaluate the risk related to inhalation of radon in the spa. On the other hand, this normalization makes easier comparisons between care rooms of the spa and between workers and patients in a considered care room. Figure 2 shows that regardless to the site, effective dose received by patients is always less than the effective dose received by workers. This one never exceeds 50% of the maximum they may be exposed to in the inhalation room or in the mud application. Patients receive the maximum (100%) in the inhalation treatment room and about 24% in the steam-up therapy room. They never go to the mining gallery and never are exposed there.

The risk due to  $^{222}\text{Rn}$  is negligible for employees and patients in this spa especially when compared to values reported for spas of other countries where workers received up to several tens of mSv [14]. Effective doses received by patients may be significant in spas of other countries. For example, in Italy the effective doses received by patients reach up to 15 mSv [15] while in the Austrian spa of Badgastein, they are more exposed since the effective dose received varies between 2 to 45 mSv [2].

## 5. Conclusion

Concentrations of  $^{222}\text{Rn}$  in the different sites of the spa are very variable. The mean value was about  $170 \text{ Bqm}^{-3}$  and is lower than those reported for other countries. A model based on a dosimetric approach was adopted to estimate radon risk considering the  $^{222}\text{Rn}$  concentration, the time spent in the spa, and the radioactive equilibrium factor F. The annual effective dose for workers (between 0.15 to 1.7 mSv) and for patients ( $2.8 \cdot 10^{-4}$  to  $110.0 \cdot 10^{-4}$  mSv) are within the ICRP recommended values, respectively 20 mSv and 1mSv. The risk, due to the inhalation of  $^{222}\text{Rn}$  and its progeny, for workers and patients is then negligible in this spa. Thus, employees in this spa would not be considered to be occupationally exposed and control or monitoring is not necessary.

This work is under progress and in order to improve characterization of exposure to  $^{222}\text{Rn}$  in thermal spas and then estimate efficiently the effective doses received by workers and by patients, one has to proceed to the determination of the size of aerosols and to the measurement of the radioactive equilibrium factor F in each site of the spa. This study is also being extended to the other spas of Tunisia.

## REFERENCES

- [1] BIANCOTTO, R., et al., "Radon concentration in mineral and thermal waters of Veneto: an estimate of ingestion and inhalation doses", *Radiation Protection Dosimetry* 36, pp 129-135. (1991)
- [2] BOGOLYUBO, V.M. et al., "The "risk benefit" ratio in Radon Therapy", *Congrès international de Merano, Natural Radioactivity and thermal waters*, Editor : Terme, 39012 Merano, Italia, Vol.1, pp 109-114.(1983)
- [3] SCHMIDT, S., REYSS, J. L. "Radium as internal tracer of Mediterranean Outflow Water". *Journ. Geophys. Res*, 101, 3589-3596. (1996)
- [4] ANDRU, J., "La pratique des méthodes de detection du radon par les plastiques détecteurs solides de traces nucléaires", *Radioprotection*. Vol. 33, n°4, 501-513. (1998)
- [5] INTERNATIONAL COMMISSION ON RADIOLOGICAL PROTECTION, *Protection against radon 222 at home and at work*, Publication 65, Pergamon Press, Oxford (1993).
- [6] LABIDI, S., "Etude des caractéristiques physico-chimiques et radiologiques des eaux thermominérales tunisiennes", PhD thesis, Univ. of Tunis El Manar, Tunis (2004).
- [7] AMEON, R., et al., "Etude de l'activité volumique en radon dans une station thermale française : Cas d'Evau-les-bains", *Rapport DPRE/SERGD/00-51*. IPSN. (2000)
- [8] FONTAN, M., et al., "Quelques études sur l'action des eaux, boues et gaz thermaux radioactifs de Saint-Amand-les-eaux", *Journal Français d'Hydrologie*, Vol.11, N° 31, pp 55-62. (1980)
- [9] SZERBIN, P., "Natural radioactivity of certain spas and caves in Hungary", *Environment International*, 22, suppl. 1, S389-398. (1996)
- [10] SOTO, J., et al., "Radioactivity in Spanish spas", *The Science of the Total Environment*, Vol.162, pp187-192. (1995)
- [11] SOTO, J., GOMEZ, J., "Occupational Doses from Radon in Spanish Spas", *Health Physics*, Vol. 76, N° 4, pp 398-401. (1999)
- [12] LETTNER, H., et al., "Occupational exposure to radon in treatment facilities of the radon-spa Badgastein, Austria", *Environment International*, 22, suppl.1, S399-S407. (1996)
- [13] MORINAGA, H., et al., "Radioactivity of water and air in Misasa spa, Japan", *Radiation Protection Dosimetry*, Vol.7, 1-4, pp 295-297. (1984)
- [14] BESANCON, F., "Radon thermal inhalé", *Presse thermale et climatique*, Vol.127, N°1, pp1-26. (1990)
- [15] SCIOCCETTI, G., "Aspetti dosimetrici dell'esposizione alle radiazioni nelle stazioni termali radioattive". *Congrès international de Merano, Natural Radioactivity and thermal waters*, Editor : Terme, 39012 Merano, Italia, Vol.1, 28-39, (1983)

# Natural radioactivity of building material in South Africa

I. Louw, A. Faanhof

*South African Nuclear Energy Corporation, Pretoria, South Africa*

**Abstract** A study was performed in order to assess whether the cement manufacturing industry in South Africa falls within the scope of regulatory control. A selection of cement and their raw materials were analysed for Naturally Occurring Radioactive Materials (NORMs), which includes radionuclides of uranium, thorium, radium, lead, polonium and potassium. The results were evaluated against the provisions of the South African National Nuclear Regulator Act, which applies for nuclide activity values above the 500 Bq/kg level. It was found that the cement industry in South Africa should be excluded from Nuclear Regulatory Control. The effectiveness of a closed microwave digestion system for dissolving cement samples in preparation for the determination of natural decay series radionuclides, was also evaluated. To confirm the validity of the sample preparation procedure, results obtained with closed vessel microwave dissolution and subsequent radiochemical analyses were compared with results from instrumental techniques such as Instrumental Neutron Activation Analysis (INAA) and gamma-spectrometry. In general, the results obtained for samples prepared by using the microwave system showed close agreement with the values obtained using instrumental nuclear techniques. This will create the opportunity to analyse for and evaluate the exposure due to high radiotoxic nuclides like  $^{210}\text{Po}$ ,  $^{231}\text{Pa}$  and  $^{227}\text{Ac}$  otherwise overlooked by the instrumental techniques.

## 1. Introduction

Low level exposure arising from NORMs has been a topic of interest over the last two decades, due to the fact that external radiation exposure from natural occurring radionuclides contributes on average about half of the average annual dose to the human body from all radiation sources [1]. Natural radiation to which the public is exposed includes external exposure from building material, since all building material contains a certain amount of radioactivity. The natural radioactivity of building material is usually determined from the  $^{232}\text{Th}$ ,  $^{226}\text{Ra}$  and  $^{40}\text{K}$  contents. Knowledge of radioactivity levels of materials used in the building industry is important in the assessment of possible radiological hazards to human health. This knowledge is essential for the development of standards and guidelines for the use and management of these materials. The contents of  $^{232}\text{Th}$ ,  $^{226}\text{Ra}$  and  $^{40}\text{K}$  in raw and processed material can vary considerably according to the geological locations and geo-chemical characteristics of those materials. The specific radioactivity of different building materials has been assessed by many authors in different countries [2–10]. The activity concentrations of  $^{232}\text{Th}$ ,  $^{226}\text{Ra}$  and  $^{40}\text{K}$  are measured by gamma spectrometry without any sample preparation except for sieving, grinding or milling of the sample. However, care should be taken in assuming equilibrium of  $^{232}\text{Th}$  with its progeny with high gamma energies ( $^{228}\text{Ac}$  and  $^{208}\text{Tl}$ ), which may be under- or overestimated depending on the  $^{228}\text{Ra}$  and  $^{228}\text{Th}$  contents. The better practice would be to analyze the material also for  $^{232}\text{Th}$ , e.g. by neutron activation analysis.

Methods for NORM analyses in water samples have been used with satisfactory results in the radioanalytical laboratory (RadioAnalysis) of the South African Nuclear Energy Corporation (Necsa) for more than a decade. Using radiochemical methods for the analyses of environmental samples, typical problems are not associated with the efficiency of the instrumental method but rather with the sample preparation method. Sample preparation techniques need to provide accuracy, economic efficiency and safety. We are currently concentrating on the dissolution/destruction of various matrices, essential for environmental and health monitoring in Southern Africa, for NORM analyses.

Raw materials in the cement industry are difficult to dissolve and are either decomposed by prolonged acid digestion with a mixture of hydrochloric and hydrofluoric acid or by high-temperature fusion [11–13]. These techniques are time consuming and generate large quantities of secondary waste and fume hood emissions. There is also the possibility of trace elements loss and contamination during these steps. Closed-vessel microwave digestion technology maximizes sample decomposition through rapid heating at elevated pressures and has become increasingly popular for analysis of a variety of samples. Microwave technology has had limited application in the radiochemical laboratory because of constraints on sample size resulting from vessel pressure limitations. Usually for radiochemical

procedures larger sample sizes (5-10 g) are dictated to achieve the required sensitivity. Levels in the order of 1 mBq/kg are often required for dose evaluations [14]. However, because of the relatively high activity concentration allowed for building materials, microwave digestion becomes an option for sample analyses.

Like other building materials, radioactivity in cement gives rise to external radiation exposure in buildings. A study was performed in order to assess whether the cement manufacturing industry in South Africa falls within the scope of regulatory control. A selection of cements and their raw materials were analysed for NORMs. The results for the measured activities and the radium equivalent concentrations are presented. The results are evaluated against the provisions of the South African National Nuclear Regulator Act, as well as the European radioactivity index.

The effectiveness of the microwave digestion system for dissolving cement samples in preparation for the determination of natural decay series radionuclides was evaluated. Samples were digested by using microwave dissolution and analysed by radiochemical separation and  $\alpha$ -spectrometry. Recoveries and the activity concentrations obtained are presented and compared with results obtained by instrumental nuclear techniques.

## **2. Experimental**

### **2.1. Apparatus**

A microwave system (Milestone Ethos Touch Control) was used to digest the samples. It has a built-in temperature control which directly monitors the vessel content reaction temperature, as well as infrared external temperature control for continuous temperature control of all vessels. A high pressure microwave digestion rotor contains six vessels for acid digestion of samples at an operating pressure of up to 100 bar. All vessels are protected by a patented re-closing vent and reseal mechanism. The power of the system's magnetron is 1200 Watt, with 1000 watt delivered inside the working chamber. The system is controlled with a touch screen control terminal.

### **2.2. Samples and sample preparation**

Twenty-six solid samples were received for analysis of their radioactivity content. The samples were all cement and cement by-products (e.g. gypsum, slag, silica fume and fly ash) but varied in composition and physical appearance. The radionuclides of interest are NORMs and typically include uranium ( $^{238}\text{U}$ ,  $^{235}\text{U}$ ), thorium ( $^{232}\text{Th}$ ,  $^{230}\text{Th}$ ,  $^{228}\text{Th}$ ,  $^{227}\text{Th}$ ), radium ( $^{226}\text{Ra}$ ,  $^{228}\text{Ra}$ ), as well as  $^{210}\text{Pb}$ ,  $^{210}\text{Po}$  and  $^{40}\text{K}$ .  $^{227}\text{Th}$  can be regarded an indicator for the highly radiotoxic  $^{227}\text{Ac}$ . Samples were dried overnight at 105 °C and then milled and homogenised the following day. The drying temperature is kept relatively low in order to prevent losses of volatile elements such as lead and polonium. Fractions of approximately 0.3 grams of sample material were brought into solution by microwave digestion after addition of a suitable tracer. The samples were digested for 20 minutes at 200 °C with 8 ml concentrated HCl, 3 ml HNO<sub>3</sub> and 1 ml HF, using a two-step program. After digestion, the samples were evaporated on a hot plate and dissolved in the suitable acid medium for radiochemical analysis.

### **2.3. Radioactivity Analysis**

All analytical methods are validated and documented in the RadioAnalysis Quality System which is based on ISO/IEC Standard 17025. RadioAnalysis is an accredited laboratory with the South African National Accreditation Systems (SANAS).

#### **2.3.1. Radiochemical methods**

- Polonium was pre-concentrated from the solution, acidified with hydrochloric acid, by spontaneous electro deposition onto a silver disc. The yield of the deposition procedure was determined by using  $^{209}\text{Po}$  as a tracer. The alpha activities of  $^{209}\text{Po}$  and  $^{210}\text{Po}$  were then counted with  $\alpha$ -spectrometry.
- Thorium was separated from interfering nuclides on a reversed-phase extraction column (EiChrom

TruResin) followed by a cation exchange separation.  $^{229}\text{Th}$  tracer was added as a tracer for chemical yield determination. The final eluate was deposited onto a filter paper using  $\text{LaF}_3$  precipitation, and counted with  $\alpha$ -spectrometry.

### 2.3.2. Instrumental techniques

- For determination of the U and Th element concentrations, sub-samples of 200 mg each were weighed out in specially designed irradiation capsules and irradiated in the SAFARI research reactor. The uranium concentration ( $\mu\text{g/g}$ ) was determined by Delayed Neutron Counting (DNC). Samples were counted again after a cooling-of period of approximately 7 days on a well-type HPGe gamma detector for determination of the thorium concentration ( $\mu\text{g/g}$ ).
- A sub-sample of approximately 20 grams was analysed on a low-background high energy HPGe detector system with 20 % relative efficiency. The spectral data was analysed for the radionuclides  $^{226}\text{Ra}$ ,  $^{228}\text{Ra}$ ,  $^{228}\text{Th}$  and  $^{40}\text{K}$ . Samples were sealed and stored for 4 weeks before counting to allow for radium and its short-lived progeny to reach equilibrium.
- For  $^{210}\text{Pb}$  analyses, samples were adjusted to a specific counting geometry for analysis on an HPGe gamma detector system with an ultra-thin beryllium window for low energy counting. Absorption corrections were made for each sample by counting a collimated absorption source.

## 3. Results and Discussion

### 3.1. Microwave dissolution

Various acid mixtures were examined to find the best dissolution procedure for the cement-related samples. A combination of 8 ml HCl, 2 ml  $\text{HNO}_3$  and 1 ml HF proved to be the most satisfactory. Total dissolution of most of the samples was achieved resulting in clear, pale yellow solutions. In some solutions a small amount of flocculent precipitate was observed, which was filtered off. Addition of  $\text{H}_3\text{PO}_4$  improved the dissolution of especially the slag and silica-fume samples. This acid is however not compatible with the radiochemical methods for Th since absorption of Th on TruSpec resin in 1 M  $\text{H}_3\text{PO}_4$  is 4 magnitudes lower than in 2.5 M  $\text{HNO}_3$  [15].

The removal or reduction of the quantity of HCl and HF acids prior to analysis is desirable, because both may interfere with analytical methods or equipment with glass components. Both of these acids may be removed by mild heating to drive off these reagents. The samples were evaporated to near dryness and used as is for Po analysis but were filtered using Whatman for Th analysis because small particles tend to clog the very fine resin and causes a decrease in flow rate through the columns. Residues were dissolved in 2 M HCl for Po- and in 2M  $\text{HNO}_3$  for Th analysis.

The maximum amount of sample which can be digested is 0.3 g. This limits the minimum detectable activity concentration of the method to 5-10 Bq/kg, which is sufficient to evaluate samples against the 500 Bq/kg criterion. The average yields of 53% ( $\pm 16\%$ ) and 57% ( $\pm 14\%$ ) for Th- and Po- analysis respectively compare well to yields routinely obtained for water samples where no sample preparation is done. Losses due to the digestion procedure are therefore negligible.

### 3.2. Radiochemical versus instrumental techniques

Accuracy of the radiochemical method was determined by comparison of the results for  $^{232}\text{Th}$  and  $^{228}\text{Th}$  with those obtained by independent techniques. Activity concentrations obtained by both methods for one sample of each type of material are shown in Table I. As can be seen from the table, there is excellent comparison between radiochemical and instrumental results for individual samples.

Regression lines are useful to compare two methods over a range of concentrations [16]. The results for the 26 samples were plotted on a regression line. The 95% confidence limits for the intercept (c) and slope (m) of the regression lines are  $c = 6.67 \pm 9.98$ ,  $m = 1.04 \pm 0.05$  and  $c = 7.41 \pm 13.66$ ,  $m = 0.97 \pm 0.06$  for  $^{232}\text{Th}$  and  $^{228}\text{Th}$  respectively. From these figures it is clear that the calculated slope and intercept do not differ significantly from the "ideal" values of 0 and 1, and thus that there is no evidence for systematic difference between the two sets of results. This confirms that total dissolution

has been achieved. The correlation coefficient of the two regression lines were 0.976 and 0.960 for  $^{232}\text{Th}$  and  $^{228}\text{Th}$  respectively. The deviation from 1 is due to the relatively high uncertainty in the analyses by both methods.

Results for  $^{210}\text{Po}$  are not comparable with  $^{210}\text{Pb}$  because of the fairly low sensitivity for  $^{210}\text{Pb}$  by gamma spectrometry. Any differences to be expected between  $^{210}\text{Pb}$  and  $^{210}\text{Po}$  will be due to the manufacturing process rather than as a result of the digestion procedure.

### 3.3. Evaluation against the South African National Nuclear Regulator Act

Activity concentrations for the radionuclides of interest for one sample of each type of material investigated are given in Table I. The reported uncertainty is calculated from counting statistics, and is not the normal standard deviation on replicate analysis. The mean concentrations of  $^{232}\text{Th}$ ,  $^{226}\text{Ra}$  and  $^{40}\text{K}$  of the various materials are given in Table II. The reported  $^{210}\text{Po}$  activity includes supported and unsupported  $^{210}\text{Po}$ . The analysis of  $^{210}\text{Po}$  is important, since equilibrium with  $^{210}\text{Pb}$  cannot be assumed under the manufacturing conditions. The combustion process may cause the evaporation of  $^{210}\text{Pb}$  and  $^{210}\text{Po}$ , causing an enhancement of these nuclides in the fumes of the stack. Contact with the feed material will cause most of the condensed  $^{210}\text{Pb}$  and  $^{210}\text{Po}$  to be transferred and recycled at some disequilibrium concentration. Results for  $^{210}\text{Pb}$  are not reliable because of a fairly low sensitivity. In order to determine the true  $^{210}\text{Pb}$  content, and therefore extrapolate the results for  $^{210}\text{Pb}$  and  $^{210}\text{Po}$  to the time of sampling, it is recommended to repeat the  $^{210}\text{Po}$  analysis after another three month period.  $^{234}\text{U}$  has not been analysed. It is assumed that  $^{238}\text{U}$  and  $^{234}\text{U}$  will be in equilibrium under the specific manufacturing conditions.

**Table I: Activity concentrations and radium equivalent activities of cement and its products (Bq/kg)**

*Note: The results for only one sample of each kind of material are shown; averages in Table II.*

Nuclide	Material				
	Cement	Gypsum	Slag	Silica fume	Fly ash
$^{238}\text{U}$	$11.9 \pm 2.6$	$31.9 \pm 4.1$	$84.9 \pm 6.9$	NA	$203 \pm 3$
$^{230}\text{Th}$	$34.7 \pm 3.5$	$91.3 \pm 8.6$	$108 \pm 6$	$23.8 \pm 3.8$	$176 \pm 14$
$^{226}\text{Ra}$	$13.5 \pm 4.8$	$87.8 \pm 10.7$	$106 \pm 10$	$47.4 \pm 8.6$	$152 \pm 10$
$^{210}\text{Pb}$	< 120	< 180	< 140	< 200	$148 \pm 33$
$^{210}\text{Po}$	$15.9 \pm 2.0^*$	$105 \pm 6^*$	$16.7 \pm 2.1^*$	$121 \pm 7^*$	$192 \pm 10^*$
$^{235}\text{U}$	$0.55 \pm 0.12$	$1.47 \pm 0.19$	$3.9 \pm 0.3$	NA	$9.33 \pm 0.33$
$^{227}\text{Th}$	$5.4 \pm 1.8$	$5.6 \pm 3.4$	$13.6 \pm 3.6$	$1.2 \pm 2.3$	$33.6 \pm 10.5$
$^{232}\text{Th}$	$18.2 \pm 1.0$	$12.1 \pm 0.8$	$67.6 \pm 3.4$	$2.7 \pm 0.6$	$161 \pm 6$
	$19.7 \pm 2.6^*$	$14.3 \pm 3.4^*$	$65.2 \pm 4.6^*$	$2.8 \pm 1.3^*$	$166 \pm 14^*$
$^{228}\text{Ra}$	$11.2 \pm 6.5$	$13.9 \pm 8.3$	$88.5 \pm 13.0$	$57.5 \pm 13.6$	$166 \pm 15$
$^{228}\text{Th}$	$22.2 \pm 5.0$	$9.4 \pm 4.2$	$73.8 \pm 11.0$	NA	$177 \pm 11$
	$26.9 \pm 3.1^*$	$18.1 \pm 4.1$	$76.5 \pm 4.9^*$	$6.0 \pm 2.1^*$	$175 \pm 14^*$
$^{40}\text{K}$	$245 \pm 39$	< 180	$96.7 \pm 46.4$	$599 \pm 79$	$176 \pm 36$
$\text{Ra}_{\text{eq}}$	60.5	108.2	206.7	97.5	402.9
$I_{\gamma}$	0.225	0.364	0.712	0.372	1.39
$I_{\gamma}$ (mean)	$0.29 \pm 0.14$	$0.27 \pm 0.09$	$0.72 \pm 0.19$		$1.41 \pm 0.02$
n	15	5	3	1	2

\* Radiochemical results

In terms of provisions of the South African National Nuclear Regulator Act [17] any material with a radioactivity content of less than 500 Bq/kg per individual nuclide (for natural occurring radioactive nuclides of U and Th and their progeny) are exempted from legislation. The measured nuclide-specific activity levels are all well below the level of 500 Bq/kg. The gypsum samples have slightly higher nuclides activities than the respective cement samples. The silica fume sample is enriched in radium (both  $^{226}\text{Ra}$  and  $^{228}\text{Ra}$ ) and  $^{210}\text{Po}$ . The slag samples generally have higher activity content than the rest of the samples. It would appear as if these materials were subjected to high temperatures since their  $^{210}\text{Po}$  content is markedly lower than that of the other nuclides. Fly ash samples have nuclide specific activities varying just above and below 200 Bq/kg.

Cement consists mainly of calcium oxide (60 wt%), silica, alumina, iron oxide and gypsum present in the raw materials obtained from limestone quarries. Some magnesium oxide is also present but varies with the origin of the raw materials. During cement production different additive agents, such as gypsum, fly-ash and blast furnace slag, are added to the clinker and put into a ball mill (Fig. 1). It is well-known that the natural radioactivity in material produced from raw waste material (e.g. fly ash, slag and clinker) are often enriched [6,9,18]. The natural radioactivity of fly-ash are often one order of magnitude higher than the activity concentrations of other cement components that are in their natural form.

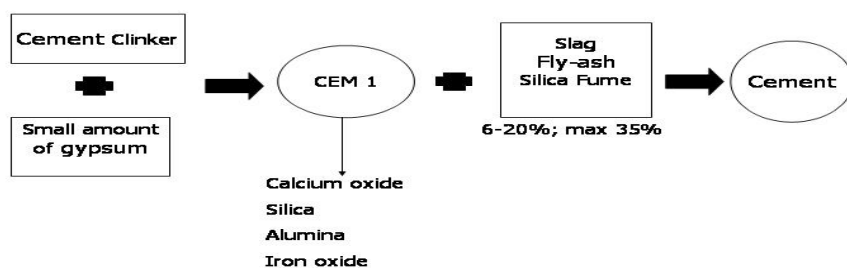

FIG. 1: Production of Cement

The higher activity levels found in individual materials (such as slag and fly ash) should not pose an environmental health problem since these substances constitute a relatively small portion of the materials used for cement production. Based on the analytical results of the samples of these materials used in the manufacture of the cement in South Africa, it was concluded that the industry should be excluded from Nuclear Regularly control.

### 3.4. Evaluation against European Radioactivity Index

A number of indexes dealing with the assessment of the excess gamma radiation originating from building materials have been proposed. The most widely used radiation hazard index, the radium equivalent activity ( $Ra_{eq}$ ) is convenient for comparing the specific radioactivity of materials [2].

The  $Ra_{eq}$  value is calculated using equation 1:

$$Ra_{eq} = C_{Ra} + 1.43C_{Th} + 0.077C_K \quad (1)$$

where  $C_{Ra}$ ,  $C_{Th}$ , and  $C_K$ , are the activity concentrations (Bq/kg) of the respective radionuclides.

A maximum Ra equivalent activity of 370 Bq/kg limits the external gamma radiation dose to less than 1.5 mSv/a. The calculated indexes for individual samples of this study are shown in Table I, the means for the different materials are given in Table II. The  $Ra_{eq}$  values for cement, gypsum and slag samples are below the maximum limit. The only material which may need regulation according to this index is

fly ash. It should be clear that even though a material (e.g. fly ash) would still be acceptable according to South African legislation it could exceed the maximum radium equivalent value by far. A process of negotiating with the National Nuclear Regulator may be necessary, on the need to participate in the international process to harmonise exemption levels to accommodate international trade.

According to the regulations of recommendation No 112 of the European commission [19], building materials should be exempted from all restrictions concerning their radioactivity if the excessive gamma-radiation due to those materials causes an increase of the annual effective dose received by an individual by a maximum of 0.3 mSv. Regulatory control should be considered for materials that give rise to doses of between 0.3 mSv and 1 mSv per annum, and those above 1 mSv must be regulated. This criterion should apply if cement is to be exported from South Africa to countries of the European Community.

The gamma-index ( $I_\gamma$ ) proposed by the European Commission was calculated using equation (2).

$$I_\gamma = (C_{Ra} / 300) + (C_{Th} / 200) + (C_K / 3000) \quad (2)$$

where  $C_{Ra}$ ,  $C_{Th}$  and  $C_K$  are the  $^{226}\text{Ra}$ ,  $^{232}\text{Th}$  and  $^{40}\text{K}$  activity concentrations (Bq/kg) in the building material.

The activity concentration index should be used only as a screening tool for material which might be of concern. Any actual decision on restricting the use of a material should be based on a specific dose assessment. The calculated gamma index of the selected samples, as well as the mean of all samples, is shown in Table I. For cement, gypsum and silica fume samples the values of  $I_\gamma$  are less than 0.5, which implies an exposure level of less than 0.3 mSv per annum. Though slag and fly-ash materials exceed the recommended exemption level, these raw materials are used in restricted amounts (< 30%) and the final cement product is therefore expected to be exempted. Again it should be noted that materials acceptable according to South African legislation can exceed the maximum gamma-index and discussions may be required with the National Nuclear Regulator to accommodate international trade.

Another aspect that needs to be brought to the attention of the South African National Nuclear Regulator is the statement in regulation 388 of 28 April 2006 [20] about the exclusion where the Act does not apply if “the level of radioactivity concentration of each radioactive nuclides in materials is below 50 Bq/g for potassium-40 for all other materials” is at least odd since the maximum activity of potassium-40 in a material is 31 Bq/g; i.e. in pure potassium metal.

### ***3.5. Comparison to world averages***

In Table II the activity concentrations of  $^{226}\text{Ra}$ ,  $^{232}\text{Th}$  and  $^{40}\text{K}$  obtained for cement-related samples in other studies are given for comparison. The activities of each material and radionuclide show a wide range of values. The  $Ra_{eq}$  value obtained for cement in the present study are noticeably lower than those of other countries, except Egypt. For fly ash it is high and similar to Australian samples.  $Ra_{eq}$  values for slag are slightly higher than those of China and India, but lower than Australian samples.

The data are compared to the respective radionuclide concentrations of soil. The activity concentrations of the final cement product do not exceed the world wide average for soil [21], although individual material (fly ash and slag) do have significantly higher activities.



**Table II: Comparison of activity concentrations and radium equivalent activities of cement with other countries (Bq/kg)**

Country	$^{40}\text{K}$	$^{226}\text{Ra}$	$^{232}\text{Th}$	$\text{Ra}_{\text{eq}}$	Reference
<b>Cement</b>					
Australia	114.7	51.8	48.1	129.4	2
Bangladesh	523	29.7	54.3	148	3
Egypt	40.3	25.3	9.6	42.2	4
India	432.2	37.0	24.1	104.7	6
China	181 ± 39	58.5 ± 7.5	38.6 ± 5.4	127.7	9
China	174 ± 9	68.3 ± 3.6	51.7 ± 5.4	162.8	10
Bangladesh	506 ± 30		132 ± 16		8
South Africa	122 ± 89	27.2 ± 5.7	33.5 ± 22.3	84.5 ± 54.4	This work
<b>Gypsum</b>					
Bangladesh	89.5 ± 16.6		39.9 ± 8.7		8
South Africa	143 ± 41	66.6 ± 35.0	18.3 ± 12.2	104 ± 56	This work
<b>Fly ash</b>					
Australia	203	96.2	170	355	2
China	357 ± 67	86.7 ± 36.2	56.4 ± 24.6	194.8	9
India	88.4	45.1	39.9	109.2	6
South Africa	150 ± 36	149 ± 4	172 ± 8	406 ± 19	This work
<b>Slag</b>					
Australia	141	181	100	340	2
China	324 ± 56	91.3 ± 13.6	63.2 ± 18.2	207	9
India	145.1	67.3	77.7	189.8	6
South Africa	195 ± 93	123 ± 18	80 ± 13	252 ± 43	This work
<b>Soil</b>	400	35	30		20

#### 4. Conclusions

From the above discussion it may be concluded that the radiochemical determination of  $^{228}\text{Th}$  and  $^{232}\text{Th}$  in cement is possible with acceptable accuracy and precision after the decomposition of the sample by microwave digestion, and that the digestion of the samples proceed quantitatively. Sample preparation by microwave is a very promising technique with high relative percent recoveries, low acid consumption, short digestion time, almost no required supervision, and a low potential for contamination.

Based on the analytical results of the samples of those materials used in manufacturing cement in South Africa, it was concluded that the industry should be excluded from Nuclear Regulatory control. Even though individual raw material (slag, fly ash) exceeds the recommended exemption levels for exposure, the final cement product is expected to be exempted, since these materials are used in restricted amounts. However, the activity limits used for regulatory control in South Africa does not automatically mean that the materials are acceptable according to international standards and accordingly could result in trade restrictions. In general results obtained are comparable to similar studies undertaken in other countries.

#### 5. Acknowledgement

The authors thank the personnel from the Radioanalytical Laboratory at NECSA for their invaluable assistance and dedicated work in performing the measurements.

## REFERENCES

- [1] UNITED NATIONS SCIENTIFIC COMMITTEE ON THE EFFECTS OF IONIZING RADIATION, Sources and effects of Ionizing Radiation, Unsear Report 43, UN, New York (1982).
- [2] BERETKA, J., MATHEW, P.J., Natural radioactivity of Australian building materials, industrial wastes and by-products, *Health Phys.* **48** 1 (1995) 87.
- [3] ALAM, M.N., et al., Radiation dose estimation from the radioactivity analysis of lime and cement used in Bangladesh, *J. Environ. Radioact.* **42** (1999) 77.
- [4] EL-TAHAWY, M.S., HIGGY, R.H., Natural radioactivity in different types of bricks fabricated and used in the Cairo region, *Appl. Radiat. Isot.* **46** (1995) 1401.
- [5] HAYUMBU, P., et al., Natural radioactivity in Zambian building materials collected from Lusaka, *J. Radioanal. Nucl. Chem. Letters* **199** 3 (1995) 229.
- [6] KUMAR, V., et al., Natural radioactivity of Indian building materials and by-products, *Appl. Radiat. Isot.* **51** (1999) 93.
- [7] LEE, E.M., et al., Natural radioactivity in building materials in the Republic of Ireland, *Health Phys.* **86** 4 (2004) 378.
- [8] MOLLAH, A.S., et al., Natural radioactivity of some building materials used in Bangladesh, *Health Phys.* **50** 6 (1986) 849.
- [9] XINWEI, L., Natural radioactivity in some building materials and by-products of Shaanxi, China, *J. Radioanal. Nucl. Chem.* **262** 3 (2004) 775.
- [10] XINWEI, L., Natural radioactivity in some building materials of Xian, China, *Radiation Measurements* **40** (2005) 94.
- [11] DULUDE, G.R., et al., Determination of calcium in cement by AAS, *Anal. Chem.* **53** (1981) 2100.
- [12] LAU, O., et al., Analysis of siliceous materials and coal by atomic absorption with fusion for sample decomposition, *Talanta* **51** (2000) 1009.
- [13] LAW, O., et al., Analysis of cement and cement raw meal by atomic absorption spectrophotometry using a new fusion agent, *Talanta* **42** (1995) 1265.
- [14] FAANHOF, A., LOUW, I., The measurement of natural radioactivity in fish and the impact on humans, *J. Radioanal. Nucl. Chem.* **249** 1 (2001) 227.
- [15] NOUR, S., et al., <sup>234</sup>Th analysis of marine sediments via extraction chromatography and liquid scintillation counting, *Appl. Radiat. Isot.* **57** (2002) 235.
- [16] MILLER, J.C., MILLER, J.N., *Statistics for Analytical Chemistry*, Ellis Horwood Limited, West Sussex, England (1984).
- [17] SOUTH AFRICAN GOVERNMENT GAZETTE, Vol. 414 no 20760, National Nuclear Regulator Act, Act no 47 on Safety Standards and Regulatory Practise (1999).
- [18] BARANYAI, L., Measuring the enrichment of fly-ash in cement grinding on the basis of its natural radioactivity, *Appl. Radiat. Isot.* **37** (1986) 1111.
- [19] EUROPEAN COMMISSION, Report on Radiological Protection Principles Concerning the Natural Radioactivity of Building Material, Radiation Protection No. 112, Luxemburg (1999).
- [20] SOUTH AFRICAN GOVERNMENT GAZETTE, Vol. 490 No.28755, Department of Minerals and Energy, No. R. 388 (2006).
- [21] UNITED NATIONS SCIENTIFIC COMMITTEE ON THE EFFECTS OF ATOMIC RADIATION, Sources and effects of Ionizing Radiation, Unsear Vol 1, UN, New York (2000).

# Radiological impact of a coal fired power station in Spain

A. Baeza<sup>a</sup>, D. Cancio<sup>b</sup>, J.A. Corbacho<sup>a</sup>, J.C. Mora<sup>b</sup>, B. Robles<sup>b</sup>, A. Suárez

<sup>a</sup> Environmental Radioactivity Laboratory,  
University of Extremadura, Avda. De la Universidad SN  
10071 Cáceres

<sup>b</sup> Radiological Protection of the Public and the Environment Unit,  
CIEMAT, Avda. Complutense, No. 22.  
28040 Madrid

Spain

**Abstract.** The radiological evaluation of the workers and public potentially affected by the operation of the Teruel Coal-fired Power Plant (TCPP) is presented in the paper. This evaluation is part of a wider study comprising four of the biggest Spanish coal fired power stations. The project is sponsored by the Spanish Nuclear Safety Council and carried out by CIEMAT and the University of Extremadura. Based on local measurements and modelling, the main conclusion of this study is that both public and workers evaluated doses are negligible from a radiological protection point of view.

## 1. Introduction

The main goal of the project is to assess the radiological impact caused by the operation of each of the four largest coal fired power stations in Spain. The study shows the impact caused by this type of installation on workers, the environment and the public in the area of influence. The selected power plants show differences related to the start-up dates, geographic and climate environments, coal mixtures and uses of the generated bottom and fly ashes.

The paper shows the results obtained for the Teruel Coal-fired Power Plant (TCPP). This work is included in a project developed jointly by CIEMAT (Radiological Protection of the Public and the Environment Unit) and the University of Extremadura (Environmental Radioactivity Laboratory) and sponsored by the Nuclear Safety Council in their Research and Development Programme (2004-2007).

## 2. Description of the Teruel installation

The TCPP is located in a sparsely populated area in the north-east of the Teruel province (Spain). The nearest town — Andorra — lies 8 km to the south-west of the plant. The TCPP is composed of three identical units with a current total gross power output of 1101.4 MW(e). Each unit includes a boiler, a turbo alternator and a cooling tower. The facility has several common installations for the three units, namely, storage for coal and limestone used for the desulphurization process, the fly and bottom ash discharge system, the desulphurization plant and a 343 m high stack for the discharge of the combustion gases.

Nowadays, a mixture of lignite of Spanish origin (70–80 wt%) and bituminous coal imported from South Africa is burned. The lignite, which originates from the mines located in the same region, is transported by truck, while the imported coal is transported by train from Tarragona harbour to the coal storage of the plant. The limestone used in the desulphurization system comes also from a nearby mine, reaching the plant by truck.

Until 2000, the ash was deposited in two ponds situated in a zone close to the installation. Since that year the fly ash has been sold to the cement industry. Bottom ash and gypsum from the desulphurization process are currently used as backfill in the mines from where the lignite comes.

### 3. Evaluation methodology

The processes in the station that may affect the workers were characterized in order to identify those tasks which could result in any exposure to them. The processes which could affect the population were also taken into consideration. They were based on direct observations and other reports [1, 2].

For the dose evaluation of the workers six groups were defined. Table 1 presents a short résumé with a description of each group and the pathways considered.

TABLE 1. WORKER GROUPS AND PATHWAYS CONSIDERED IN THE DOSE CALCULATIONS

Group of workers	External pathway	Inhalation pathway
A1 — Truck drivers who transport lignite, bottom ash, limestone and gypsum	YES	YES
A2 — Truck drivers who transport fly ash	YES	NO
B1 — Drivers of the train for imported coal	YES	NO
B2 — Discharge wagon operators	YES	YES
D — Drivers of the bulldozers	YES	YES
E — Maintenance operators	NO	YES

For the evaluation of the dose received by the public, being a low population density zone, two possible scenarios were considered (Table 2):

- The first scenario considered was that of a person who takes a walk near the old fly ash ponds, which are of free access and placed outside the enclosure of the plant. This person could receive a dose due to external irradiation and to inhalation of resuspended particles.
- A second exposure scenario for the public located at the maximum influence point was considered, the impact here being mainly due to the gaseous effluents emitted by the stack. In this case, the inhalation component and the external irradiation due to the plume immersion and to the ground deposit were taken into account, with inhalation being the main pathway.

In both scenarios it was considered that people remained 1 h per week in the area.

TABLE 2. SCENARIOS DEFINED FOR THE DOSE EVALUATION OF THE PUBLIC

Exposed individual	External pathway	Inhalation pathway
Scenario 1 — Person in the influence zone of the fly ash ponds	YES	YES
Scenario 2 — Person in the zone of maximum impact due to the gaseous effluent	YES	YES

With the objective of carrying out these studies the following measurements were performed:

- Activity concentrations in both types of fuel (6 samples)
- Activity concentrations in the limestone used in the desulphurization plant and in the generated gypsum (4 samples).
- Activity concentrations in the bottom and fly ash (4 samples)

- Activity concentrations of the fly ash deposited in the ponds (2 samples)
- Airborne samples in the direction of the dominant winds outside the plant, in the work zones inside the installation and around the ponds (17 samples)
- Laboratory and in situ gamma spectrometry measurements of surrounding ground, both inside the plant area and in the outside area of influence (18 samples) (see Fig. 1)
- Direct equivalent ambient dose rate measurements both outside and inside the plant (32 points)
- Activity concentrations of surface waters that could be influenced by the effluents (9 points)

Table 3 shows the mean activity concentrations of several of the materials measured.

TABLE 3. MEASURED ACTIVITY CONCENTRATIONS

(nm = not measured)

Radionuclide	Mean activity concentration (Bq/kg)						
	Lignite	Imported coal	Coal mixture	Gypsum	Limestone	Fly ash	Bottom ash
$^{40}\text{K}$	104±15	<20	66±15	20±17	35±12	306±13	235±11
$^{226}\text{Ra}$	64.4±2.7	29.8±2.7	54±3	15.3±1.7	20.0±1.4	191±9	149±6
$^{232}\text{Th}$	17.6±2.6	25.4±3.1	20±3	<3	<5	74±3	66±3
$^{210}\text{Po}$	nm	nm	65±11	27±3	<0.75	257±30	57±7

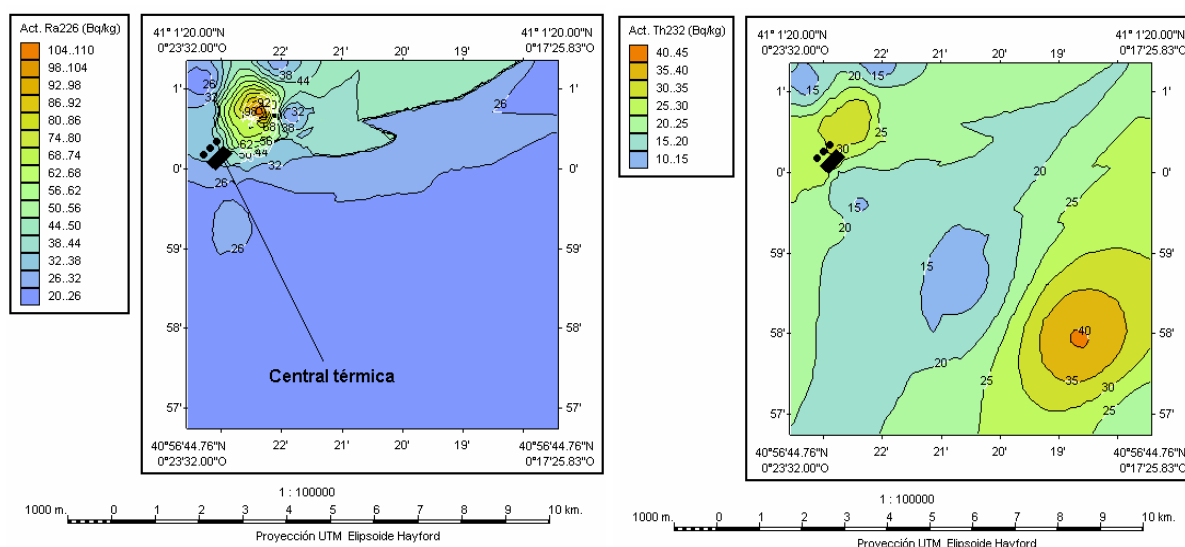

FIG. 1. Maps of isoactivity for  $^{226}\text{Ra}$  and  $^{232}\text{Th}$  in the surroundings of Teruel power station

### 3.1. Evaluation of the dose received by workers

The evaluation of the dose for each group of workers was based on the measurements obtained and on a set of reasonable hypotheses obtained from Refs [1–3] concerning the radiological impact of coal fired power stations and from direct observations of the workers. For the evaluation of the effective dose from the external irradiation received by the different groups of workers that are exposed to the materials considered in this study, namely, coals, gypsum, limestone, fly ash and bottom ash, Microshield v 5.03 from Grove Software was used, simplifying the real geometries. When possible direct equivalent ambient dose rate ( $H^*(10)$ ) measurements, at the points where workers could be

found, were used. The calculations of the inhalation dose for the natural radionuclides contained in the studied materials, was performed using a code developed by the Radiological Protection of the Public and the Environment Group of CIEMAT (the CROM code). This implements an improved screening model for dose evaluation to the critical groups due to routine discharges from nuclear and radioactive installations. The methodology used as the basis for the development of the CROM code is presented in the Ref. [4] with some added improvements based on Ref. [5].

### **3.2. Evaluation of the dose received by the public**

For the external dose evaluation in Scenario 1, direct equivalent ambient dose rate measurements taken in the zone between the ponds were used. They were corrected by the background value, which was evaluated from measurements performed at several points considered as being beyond the influence of the installation.

In Scenario 2, the dispersion of aerosols (fly ash) released from the stack was modelled using the Gaussian model implemented in CROM, fed with meteorological data from the meteorological station located in the TCPP installation. The pathways considered were internal irradiation due to inhalation, and external irradiation due to plume immersion and ground deposition.

The evaluation of internal dose due to the inhalation of radionuclides in particles resuspended from the fly ash ponds was performed using dust loading factors that were in good agreement with the values in Ref. [5] to calculate the airborne radionuclide concentrations. The dose calculations were performed using those values and the CROM code.

## **4. Results**

For the different types of workers, the effective dose ranges from 0.2 to 21  $\mu\text{Sv/a}$  (Table 4). Group D, which corresponds to the bulldozer drivers, shows the highest dose, with particle inhalation being the pathway of maximum impact. This is explained by the fact that those workers perform the movement operations of coal and bottom ash, inhaling the resuspended particles. For the public, the effective dose is negligible (Table 5), with a maximum value of 4  $\mu\text{Sv/a}$ . In Fig. 2, the contribution of each radionuclide to the dose by inhalation of an adult in Scenario 1 is shown.

TABLE 4. EFFECTIVE DOSE FOR EACH WORKER GROUP

Group	External dose ( $\mu\text{Sv/a}$ )	Internal dose ( $\mu\text{Sv/a}$ )	Effective dose ( $\mu\text{Sv/a}$ )
A1	5.3	1.87	7.17
A2	11.4	Not considered	11.4
B1	0.24	Not considered	0.24
B2	$\sim 0$	7.6	7.6
D	9.0	12.11	21.11
E	Not considered	13.81	13.81

TABLE 5. EFFECTIVE DOSE FOR THE PUBLIC (SEVEN AGE GROUPS, AS DEFINED IN THE IAEA BSS)

Exposure scenario	Exposure pathway	Effective dose ( $\mu\text{Sv/a}$ )					
		Age <1 a	Age 1–2 a	Age 2–7 a	Age 7–12 a	Age 12–17 a	Age >17 a
1	Inhalation	0.04	0.06	0.07	0.08	0.09	0.09
	External	4.17	4.17	4.17	4.17	4.17	4.17
2	Inhalation	0.06	0.10	0.11	0.14	0.15	0.15
	External	0.16	0.16	0.16	0.16	0.16	0.16

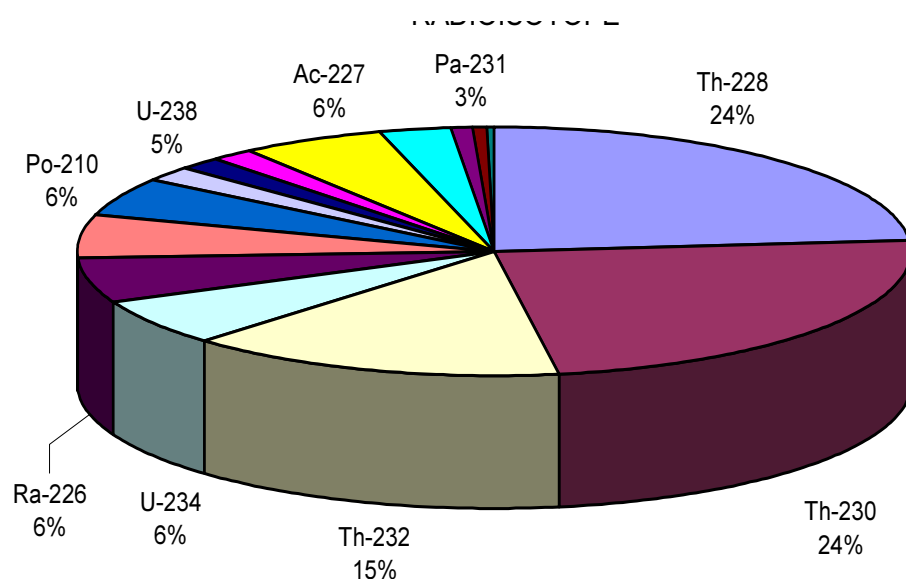

FIG. 2. Radionuclide contribution to the dose by inhalation for adults

## 5. Conclusions

The one year analysis performed on different aliquots of the coals used in the TCPP, as on the residues produced after the combustion, indicate that their radionuclide content is below the European clearance and exemption guidance for natural radionuclides [6] and is also below the 1 Bq/g recommended in the IAEA Safety Guide on exclusion, exemption and clearance [7].

The equivalent ambient dose rate measured inside the enclosure of the power plant is equal to, or in certain points even lower than, that found in points outside and beyond the influence of the installation. The zone where these levels are higher is that where the lignite received by trucks is piled up, but such levels are only 17% higher than the mean detected value in the soils around this installation.

The evaluations of the effective dose to the workers, in all the analyzed cases, give values of low significance and beneath the 1 mSv/a recommended as a reference value for requiring consideration from a radiological point of view in Refs [8, 9], with the maximum evaluated dose being only 21  $\mu\text{Sv/a}$ . For the public, the evaluated effective doses were always negligible for both scenarios considered, being in the range 0.2–4.2  $\mu\text{Sv/a}$ . Due to the values obtained in this study, the radiological impact of the activities at this power plant can be considered insignificant from the radiological protection point of view.

In Refs [1, 10] the boiler maintenance operation is mentioned as being work involving a potentially important exposure. Although in TCPP this exposure does not seem significant, because it is

performed every 2–4 years and the personnel always use individual protection to conduct this work inside the boiler, a measurement campaign will be performed to assure the correctness of these assumptions.

### ACKNOWLEDGEMENTS

The authors wish to thank ENDESA Generación and every involved worker for their valuable assistance in performing the sampling in the power station and providing all information and data needed for the dose evaluations of this study.

### REFERENCES

- [1] NATIONAL RADIOLOGICAL PROTECTION BOARD, Radiological Impact on the UK Population of Industries which Use or Produce Materials Containing Enhanced Levels of Naturally Occurring Radionuclides, Rep. NRPB-R327, NRPB, Didcot, UK (2001).
- [2] UNITED NATIONS SCIENTIFIC COMMITTEE ON THE EFFECTS OF ATOMIC RADIATION, Ionizing Radiation: Sources and Biological Effects, United Nations, New York (1982).
- [3] KARANGELOS D.J., et al., Radiological characteristics and investigation of the radioactive equilibrium in the ashes produced in lignite fired power plants, *J. Environ. Radioactivity* **77** (2004) 233–246.
- [4] INTERNATIONAL ATOMIC ENERGY AGENCY, Generic Models for Use in Assessing the Impact of Discharges of Radioactive Substances to the Environment, Safety Reports Series No. 19, IAEA, Vienna (2001).
- [5] EUROPEAN COMMISSION, Methodology for Assessing the Radiological Consequences of Routine Releases of Radionuclides to the Environment, Rep. EUR 15760 EN, Radiation Protection 72, Office for Official Publications of the European Communities, Luxembourg (1995).
- [6] EUROPEAN COMMISSION, Practical Use of the Concepts of Clearance and Exemption, Part II: Application of the Concepts of Exemption and Clearance to Natural Radiation Sources, Radiation Protection 122, Office for Official Publications of the European Communities, Luxembourg (2002).
- [7] INTERNATIONAL ATOMIC ENERGY AGENCY, Application of the Concepts of Exclusion, Exemption and Clearance, Safety Guide No RS-G-1.7, IAEA, Vienna (2004).
- [8] EUROPEAN COMMISSION, Reference Levels for Workplaces Processing Materials with Enhanced Levels of Naturally Occurring Radionuclides, Radiation Protection 95, Office for Official Publications of the European Communities, Luxembourg (1999).
- [9] EUROPEAN COMMISSION, Establishment of Reference Levels for Regulatory Control of Workplaces where Materials are Processing which Contain Enhanced Levels of Naturally-Occurring Radionuclides, Radiation Protection 107, Office for Official Publications of the European Communities, Luxembourg (1999).
- [10] VAN DER STEEN J., et al., Strategies and Methods for Optimisation of Protection against Internal Exposures of Workers from Industrial Natural Sources (SMOPIE), Final Report of the Project carried out under contract N° FIGM-CT2001-00176 by order of the European Commission, NRG, Petten Netherlands (2004).



# **Integrated assessment of possible detrimental effects caused by TENORM**

**B. Michalik\***

Central Mining Institute  
40-166 Katowice, Plac Gwarków 1  
Poland

**Abstract.** Despite of the history of artificial radionuclides ( $^{137}\text{Cs}$ ,  $^{90}\text{Sr}$  etc.) influence on biota is limited to only a few decades the overwhelming majority of present-day radioecological investigations are connected with studies of redistribution in the environment and biological action of this group of radionuclides. Far less attention has been paid to radiation risk to people and the environment caused by exposure to ionizing radiation originating from naturally occurring radioactive materials. Enhanced natural radioactivity (TENORM) touches a lot of aspects of our common life, starting from occupational risk at work places, through some “contaminated” goods or even a visit in a spa, and ending on a huge amount of bulk waste materials very often dumped in our vicinity. Each particular way of occurring of natural radioactivity determines some unique scenario of exposure, usually differing from those ones caused by artificial radionuclides. Moreover, consequences of natural radioactivity’s occurrence can be assessed from different points of view. Sometimes the public comprehension of this phenomenon is a plentiful source of very serious effects far more detrimental and painful than the direct exposure to radiation. Risk caused by naturally occurring radioactivity is a case where enforcing of ALARA rule became very complex and multidimensional. To prepare a coherent system rules and recommendation designated for the monitoring and control of risk related to the presence of natural radioactivity it is necessary at the very beginning to precise causes of concern and define the clear terms for describing risk scenarios. After that the data concerning inventory of radionuclides activity concentration, their availability and migration, transfer to biota factors, dose assessment had been collected, the effects on biota at the molecular level could be evaluated. In this article an example of such a complex risk assessment was described on base of post mining areas in Upper Silesia, Poland.

## **1. Introduction**

Radioactivity is the primordial property of matter and human environment. Since life emerged on the Earth every living organism has been exposed to ionising radiation. According to the state of the art radiation protection, some specific amount of radiation, called “natural background” is considered not to be harmful to human beings and the natural environment. But in some cases such harmless level of radiation can be enhanced due to the people’s activity. Such alteration of natural state results in increment of radiation risk to people as well as to the environment and non-human biota. The importance of risk caused by natural radioactivity firstly was underlined in the Council Directive 96/29EURATOM, laying down basic safety standards for the protection of the health of workers and the general public against the danger arising from ionizing radiation.

Since this directive came into effect, a lot of research works dealing with this matter have been done but up to now there have not been any uniform and coherent approach to the assessment of the potential detrimental effects on the environment. In comparison to the criteria for regulating the use of anthropogenic radioactivity that were generally quite clearly defined in a regulatory context, the regulation of activities involving natural radionuclides was often made on a case by case basis. As a rule, the problem of natural radioactivity has not been included in regulations dealing with radioactive waste and simultaneously was totally excluded from those ones regulating environmental protection. Finally, such hazard is rarely taken into consideration when environmental risk assessment (ERA) is carried out.

To prepare a coherent system rules and recommendation designated for the monitoring and control of risk related to the presence of natural radioactivity it is necessary to precise causes of concern and define the clear terms for describing risk scenarios at very beginning.

---

\* e-mail: [b.michalik@gig.katowice.pl](mailto:b.michalik@gig.katowice.pl)

## 2. System of natural radioactivity occurrence classification

For the first time the problems of elevated and enhanced natural radioactivity and associated radiation risk were distinguished by Gesell T.F. and Pritchard N.M. in 1975 [1]. They used the abbreviation TENR (technologically enhanced natural radioactivity). Since 1996 the problem of risk caused by natural radioactivity has been discussed widely. Some authors have followed terminology applied by Gesell and Pritchard [2,3] but a lot of different abbreviations have emerged to describe these phenomena. For example Baxter [4] applied TERM (*technologically enhanced radioactive material*), Vandenhove [5] used “*materials containing natural radionuclides in enhanced NORs*”. In Canada two names: NORM- *contaminated* and *Naturally Occurring Nuclear Substances* have been applied to distinguish non-nuclear industry from uranium ore extraction and processing [6]. Martin et al in the first report completely dealing with European industry coping with natural radioactivity used a simple descriptive name “*materials containing natural radionuclides in enhanced concentrations*”[7]. The IAEA report [8] has distinguished two situations when natural radioactivity in non-nuclear industry can cause significant increment of radiation risk: NORM (*naturally occurring radioactive materials*) and technologically enhanced NORM. Such approach was followed in many articles presented during periodic conference NORM IV held in Poland [9]. All mentioned above abbreviations are used by authors interchangeably to describe situation when the presence of natural radioactivity causes not negligible radiation risk. But after even rough analysis of branches of industry processing minerals it is clear that such enhanced risk can be created in two different ways and acronyms NORM and technologically enhanced NORM (TENORM) reflect them the best.

The term NORM (Naturally Occurring Radioactive Materials) should be used, accordingly to the definition, only in cases, when radiation hazard is due to the presence of materials with elevated concentration of natural radionuclides, significantly above the average level of radioactivity, albeit not related to or caused by any type of human’s activity. It has to be pointed out, that NORMs are taken into account in the radiation hazard assessment scenarios only in cases, when they appear in the natural or work environment due to human activity, otherwise are treated as sources of the natural background and not taken into considerations as an enhanced radiation risk.

The acronym TENORM(s) means Technologically Enhanced Naturally Occurring Radioactive Materials. This term is used for the description of any raw material, product or waste, in which concentrations of the natural radionuclides have been altered (enhanced), as a result of technological processes, to the levels causing significant increase of the radiation hazard above natural background. It does not matter if the enhancement was intentional or not. It can be seen, that in some cases NORMs are used as a stuff for the process(es) where TENORMs are created as products or by-products. On the other hand, it is possible to create TENORMs in processes, where no NORMs have been used as raw materials.

## 3. Radiation risk scenarios

Accordingly to the definitions mentioned above, processes leading to the increase of the radiation hazard due to natural radioactivity, can be distinguished and enclosed into two groups.

The first one encloses exploitation, transfer or disposal of raw materials or waste without any changes of their properties to the natural environment. Such processes are mainly performed in the industrial branches, relating to exploitation of mineral resources with elevated concentrations of natural radionuclides – phosphates, tin, titanium, niobium and rare earth metal ores. The spoils produced in the exploitation processes are in form of natural materials, with the same chemical composition and physical properties as raw materials. The enhancement of radiation hazard is usually a result of the direct exposure to its radiation and may be due to increase of the amount of waste in the installation or its release to the natural environment. Also different exploitation technologies, applied in underground mining or drilling, may lead to unintentional release of waters or gases with elevated levels of natural radioactivity. The use or at least presence of NORM is in this case crucial in creating significant radiation risk.

The second group consist of processes leading to significant mass reduction and/or with changes of chemical composition or state of aggregation which might influence further behaviour in the environment. Such processes are characteristic for industrial branches, where processing of raw materials takes place. Mass reduction in these processes may cause concentration of all impurities in produced waste materials, together with natural radioactivity. Remains with concentration of natural radionuclides several times higher than in the raw materials are often created as the results of such processes. In this case to create significant radiation risk one does not have to work with NORM and actually these processed raw materials often contain less natural radioactivity than usually is taken as the average for Earth's crust. As a matter of course, these technologies of concern are not aimed at production of natural radionuclides or deliberate use of radiation, therefore radioactive isotopes are usually accumulated in waste or by-products. Properties of such remains depend on the level of accumulation of the natural radionuclides due to the mass reduction within the process.

Independently of NORM or TENORM origin the main factors determining related risk are the scale of occurrence and magnitude of materials collected in one site. Besides the occupational risk and risk to the members of the public inhabiting the vicinity of affected areas they influence the environment where they have been dumped. As a result of the lack of appropriate regulation it was a common practice to dump such kind of waste into a heap or a settling pond, relatively to the state of aggregation, without any means of protection. Usually the total amount of waste collected in one dump reach hundred thousands cubic meters or tonnes. NORM/TENORM placed into environment set some additional processes in motion, leading to the selective transfer and accumulation of particular radionuclides and disequilibrium in chains of natural radioisotopes. Finally, the possible detrimental effect to the environment and non-human biota is not so easy to assess, especially if one takes into account that in such waste other pollutants usually occur that were concentrated in the same way as natural radionuclide.

#### **4. Problem formulation**

After the review of the literature reports it is clear that majority of nowadays radioecological investigations have been focused on environmental behaviour of artificial radionuclides. Every so often attention was paid to the radiation risk to the environment caused by ionizing radiation originating from enhanced natural radioactivity. It seems oddly, especially that the scenario of this risk differs from those one caused by artificial radionuclides introduced into the environment as a result of fallout caused by nuclear weapon tests and NPP's accidents.

Firstly, artificial radioactivity has the distinction of being odd in the environment so that there is no question when we should start to investigate it. In case of natural radioactivity that is spread over everywhere the general question is when the related hazard is significant from radiation protection point of view. The EC Directive 96/29/EURATOM did not precise the answer for this question so it became a real problem. All the current international recommendation, merely mentioning natural radioactivity, bases on dose constraints for a man and the derived activity concentration limits. Exemption and clearance levels approaches a priori assume that some certain level of radioactivity should be released from any control [10]. If such levels were low enough it would work properly even in case of application to ERA. Actually the proposed levels for artificial radioactivity are extremely low. On the contrary such levels recommended for natural radionuclides sometimes are three orders of magnitude higher. The best example is the last ICRP recommendations as in table below (Table I). For the people who know physics at least a little such differentiation between natural an artificial radiation seems a bit strange. Why ionizing radiation originating from natural sources is deemed to be less detrimental than this one originating from the artificial ones?

From the rational point of view the best justified approach to the problem of radiation risk caused by enhanced natural radioactivity is to start the assessment process when the activity concentration or external exposure is higher than local natural background in the absence of the work activities. Depending on the scale of the problem investigation can be finished at relevant stage of risk

assessment process. What is worth mentioning, such approach meets expectation of local societies inhabiting areas affected by NORM/TENORM.

TABLE I. EXEMPTION LEVELS (ACCORDING TO THE ICRP 2005 DRAFT FOR RECOMMENDATION)

Nuclides	Exclusion activity concentration [Bq g <sup>-1</sup> ]
<i>artificial</i>	0.01
<i>artificial β/γ emitters</i>	0.1
<i>Head of chain activity level <sup>238</sup>U, <sup>232</sup>Th (including all progeny)</i>	1.0
<sup>40</sup> K	10

The second difference in radioecology of artificial radioactivity and natural one is that NORM/TENORM occurs usually as limited in space source with quite well defined borders, but containing enormous amount of waste. Actually there are not any barriers or protective layers so such waste contacts directly with atmospheric precipitation and surrounding environment. So the radionuclides' leaching and then, migration, the first stages of risk creation scenario, often determine the total effect.

Unfortunately, an overwhelming majority of the available data concerning radiation risk related to the NORM/TENORM occurrence is limited only to information about mass or volume activity concentration particular radionuclides. In cases of occupational hazard or risk to the members of the public assessment it is enough to evaluate a man exposure to radiation basing on this and assuming certain risk creation scenario, calculate the effective dose [11]. Existing, well documented effective dose-health detriment relationship let one assess the hazard. But from the point of view of the environmental and non-human biota risk assessment such approach is not applicable. The reason is that there is not direct conversion from the risk factors concerning man to other species of living organisms. There are no weighting factors, no units and finally neither limits nor constraints. Such situation was strictly underlined in recent ICRP recommendation [12].

Taking into account as above to state whether the presence on NORM/TENORM can cause any detriment of environment one should carry out a multi-stage evaluation process ending with real effects identification at an appropriate level. The process should result in formulation of the relationships between: an occurrence and an exposure, an exposure and a dose, a dose and effects for non-human species representatives or the whole ecosystem. Dedicated investigations should be sequentially focused on all stages of risk creation scenario (FIG. 1.)

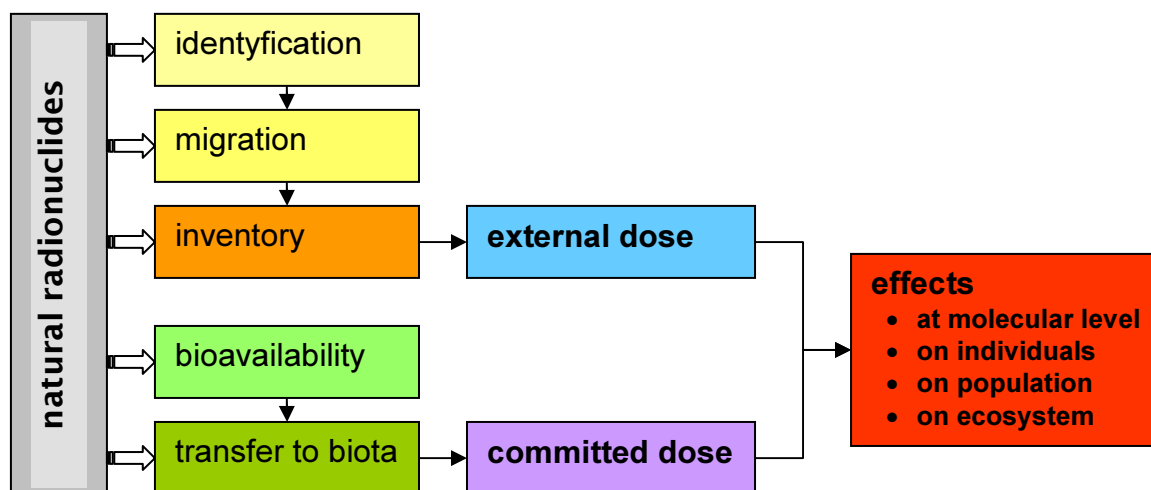

FIG. 1. A multi-stage environmental risk assessment process

## 5. ERA for areas affected by mining activity

The Upper Silesian Coal Basin (USCB) is located in the southern part of Poland and there were working up to 65 underground coal mines there. The total outflow of waste waters from these mines reached 900 000 m<sup>3</sup>/day. Due to their very high salinity (sometimes higher than 200 g/l) they have caused severe damages to the natural environment. Additionally, these waters had often elevated concentrations of radium isotopes <sup>226</sup>Ra, <sup>228</sup>Ra as well as barium and other metals. Before discharging to inland water they had to be cleaned from mechanical suspension. For this purpose settling ponds were used. As a result of precipitation and then settling radium isotopes carried on by underground water were concentrated on their bottoms. Usually the activity concentration of both radium isotopes (226 and 228) does not exceed 10 Bq/g dry mass but in some cases the activity concentration reaches 150 and 80 Bq/g for <sup>226</sup>Ra and <sup>228</sup>Ra respectively. It resulted in significant increase of dose rates - up to 42 µGy/h near the point of inflow of waters into a settling pond [13]. Besides enhancement of natural radioactivity precipitation and sedimentation processes concentrate heavy metals as well as chlorides and sulphates. The sediments with concentration of both radium isotopes exceeding 200 Bq/kg were found inside 25 settling ponds. The total capacity of all these settling ponds reaches 5 millions cubic meters [14].

For the model environmental risk assessment the former 16-hectares-natural fishing ponds that had been adapted as a settling pond was chosen. It was exploited for over 22 years. During this period about 200 million m<sup>3</sup> of waste waters had been discharged into it. It resulted in 240 000 m<sup>3</sup> of total amount of the suspension deposited in the pond. In 2002 the discharge of water was stopped and the pond was abandoned and dried. The total activity of radium collected is assessed to be about 160 GBq [13]. The range of mass activity concentration varies from 0.5 Bq/g up to 6 Bq/g dry mass. The typical ambient dose rate 1 meter the sediments is about 0.5 µSv/h but there are hot spots where the dose rate exceeds 3 µSv/h. Since the pond was dried wild plants have started to transgress its banks and now the large proportion of it is overgrown by them. The main species are: *Calamagrostis epigeios*, *Phragmites australis*, *Lepidium ruderalne*, *Cirsium vulgare*, *Matricaria perforate*, *Atriplex hastata* [15].

Sediments gathered in the pond have been created as results of radium precipitation and then sedimentation with suspended matter, mainly coal dust. So in these sediments there are no significant uranium and thorium contents. Also the age of sediments is too short to get secular equilibrium with long-lived radium progeny the activity concentration of <sup>210</sup>Pb and <sup>210</sup>Po are negligible too. Therefore, from the radiation protection point of view, radium is the most prominent radionuclide among the

potential contaminants of concern and our investigation was focused on the behaviour of radium isotopes  $^{226}\text{Ra}$  and  $^{228}\text{Ra}$  as the representatives of uranium and thorium decay series respectively.

The applied investigation was focused on two objectives. The first one, more urgent and important was to provide all stakeholders with well-founded and truthful information about the real environmental risk caused by the settling pond of concern. Such information is needed in order to decide on final destination of this area. The second objective, would be done as if by the way, is an attempt to find missing relationships among different radiation risk factors. To accomplish the assumed objectives the set of research works, covering all the stages of the proposed ERA was launched simultaneously.

### **5.1. Assessment of effect on biota**

For the quite quick assessment of the current environment health a complex approach integrating information on contaminants levels registered with routine techniques and biological estimates of adverse effects of their influence has been applied. Sediments were sampled from the pond for concern. Measurements of chemical composition and radioactivity concentration in the samples were carried out by high resolution gamma spectrometry and ICP routine procedure. To assess a hazardous potential of the contamination, phyto- and genotoxicity of the sampled sediment were estimated with *Allium cepa* plant system. This sensitive and simple bioassay was validated in international collaborative studies as an efficient test system for monitoring genotoxicity of environmental pollutants. As biological endpoints the cytogenetic and cytotoxic effects were used. There were frequency and spectrum of chromosome aberrations and mitotic abnormalities in ana-telophase cells and mitotic activity in *Allium* root tips. The contaminants levels in the investigated samples were so high, that the medium was lethal for *Allium cepa*, and a dilution of the most polluted samples was necessary. Cytogenetic damage to meristem cells of *Allium cepa* in all non-control samples of the tested sediments were significantly higher than the control value. In the most contaminated sample, mitotic activity was significantly lower but cytogenetical damage was significantly higher than in all other variants. The only essential difference from the other ones was the presence of high concentration of Ba. The clear genotoxic effect of the sampled sediment was shown, with important contribution of such severe types of cell damage as chromosome bridges and laggings. A multivariable linear regression was applied to find a relationship of the biological effect noticed with the concentrations of key contaminants in the sediment sampled [16]. But in spite of that, it turned out there was not a clear response which contaminant is the major contributor to the observed effects. Therefore it is impossible to estimate the biological risk caused by a combination of the polluting agents basing only on the knowledge of their concentrations in the environment. Such results prove that it is necessary to know how the pollutants behave in the environment, especially on the border of biotic and abiotic matter.

### **5.2. Migration, bioavailability and dose**

The above result entailed the next step of investigation, which was focused on two objectives. The first one concerned determination of mobility of radionuclides in waste materials. The second one was an evaluation of uptake of  $^{226}\text{Ra}$  and  $^{228}\text{Ra}$  by natural vegetation and the determination of site and plant-specific concentration factors (CR) in these areas.

In the literature there are not any procedures specially dedicated to radium extractions. In the light of that different sequential extraction procedures were tested to investigate the speciation of  $^{226}\text{Ra}$  and  $^{228}\text{Ra}$  in the matrix of waste material and in a control soil. There were: a modified by Bunzl the Tessier 's method [17, 18], for determining the available fraction, and a method according to BCR. The third one was only simple extraction steps using 1 M ammonium-acetate solution to determine changeable and soluble radionuclides in the samples. Finally the ratios of radium in "water", "readily exchangeable", "bound to carbonate" and in the "bound to Fe and Mn oxide" fractions were determined. In addition, an extraction procedure according to Polish regulation was applied for determining the water-soluble amount of heavy metals.

Results from different extraction methods do not show significant differences in the proportion of the mobile part of radium isotopes. But it became clear the mobile and extractable fraction depends on the chemical composition of sediments. In case when the main process of Ra incorporation into the sediment was a precipitation with the sulphate content of water or substitution in barium sulphate precipitate creates a form of  $[Ba (Ra) SO_4]$  (radiobaryte) and the amount of mobile fraction is less than 0.1% of total radium concentration. Otherwise, when radium was bound mainly to sediment grain surfaces it was by far more easily available. In this case radium behaves like other heavy metals.

The most important finding was that the relationship between the radionuclides concentration in sediment and sediment/plant CR is non-linear. This influences a lot on dose evaluation. As it was showed by simple measurement and calculation the dose caused by radionuclides incorporated to a plant (committed dose) constitutes the main proportion of the total dose. So, if CR does not depend on concentration linearly, therefore there is not a simple possibility to evaluate the total dose basing just on activity concentration in the environment.

## **6. Conclusion**

The results of the attempt to carry out the assessment of hazard associated with occurrence of certain TENORM proved that the behaviour of radium in environment can not be unified. Radium migration and their bio-availability vary from waste to waste and strongly depend on their chemical composition. This influences a lot concentration factors which are crucial for the total dose to biota (knowing a possible concentration factor it is quite easy to calculate the committed dose). Therefore environmental activity concentration of radium can be used just to calculate the exposure to external radiation that in case of radium ( $\alpha$  emitter) contributes to total dose only a little.

The obtained results also clearly proved that it is not enough to know pollutant activity concentration in particular compartment of the environment to predict an effect on biota. For existing, contaminated by NORM/TENORM sites, the genetic test-systems seem to be the most effective and efficient for an early and reliable displaying of the alterations in the ecosystems resulting from the human activity. On other hand it did not provide clear information about an agent responsible for the observed results. So it should be treated as an “early warning” signal entailing application of a thorough investigation, especially in case when the decision to make a land reclamation has to be taken. To use the whole proposed ERA process let one design and elaborate effective and efficient countermeasures or a mitigation method. For a planned work activity it is also recommended to carry out the whole proposed process of ERA to optimize potential risk.

Despite the fact that the applied extraction methods gave similar results one should remember that TENORMs usually have a specific chemical composition that is why eluents developed for common soil can not work properly and the obtained results do not comply with reality.

The general conclusion is that until the relationship total dose – ecological effect is not defined every ERA process can not be finished without a sequential survey of effect starting from individuals ending on ecosystem.

## **ACKNOWLEDGEMENT**

The investigations presented in this study were carried out within the frame of the EU-Project “WaterNORM – Project for increasing of research & development potential in the Central Mining Institute”, Contract-No. MTKD-CT-2004-003163.

## REFERENCES

- [1] Gesell T.F. and Pritchard N.M. The technologically enhanced natural radiation environment. *Health Physics* 28, 361 (1975)
- [2] Kathren, Ronald L., NORM Sources and Their Origins, *Applied Radiation and Isotopes (Incorporating Nuclear Geophysics)* Vol: 49, Issue: 3, pp. 149-168, (March 1998)
- [3] Righi S., Betti M., Bruzzi L., Mazzotti G., Monitoring of natural radioactivity in working places, *Microchemical Journal* Vol. 67, p. 119-126, (2000)
- [4] Baxter M.S. Technologically enhanced radioactivity: An Overview, *Journal of Environmental Radioactivity*, VOL. 32, Nos 1-2, 3-17, (1996)
- [5] Vandenhove H., European sites contaminated by residues from the ore-extracting and processing industries, Proceedings of the 5<sup>th</sup> International Conference on High Levels of Natural Radiation and Radon Areas, Munich, Germany, September 2000, Elsevier International Congress Series No. 1225, 2002, ISBN: 0-444-50863-5 (ICHLNRR, 2000)
- [6] Canadian Guideline for the Management of Naturally Occurring Radioactive materials, Ministry of Health, Canada (2000)
- [7] Martin A., Mead S., Wade B.O., Materials containing natural radionuclides in enhanced concentrations, Directorate-General Environment, Nuclear Safety and Civil Protection, contract No B4-3070/95/00387/MAR/C3 Final report No EUR 17625 EN, (1997)
- [8] IAEA, Technical Report Series No. 419, Extent of Environmental Contamination by Naturally Occurring Radioactive Material (NORM) and Technological Options for Mitigation, Vienna, (2003)
- [9] IAEA (2005) TEC-DOC-1472, Naturally Occurring Radioactive Materials (NORM IV), Proceedings of an International Conference, Poland, May 2004, (issued October 2005)
- [10] IAEA Safety Standards Series No. RS-G-1.7, Application of the Concepts of Exclusion, Exemption and Clearance Safety Guide, (2004)
- [11] Radiation Protection 107. Establishment of reference levels for regulatory control of workplaces where materials are processed which contain enhanced levels of naturally-occurring radionuclides, European Commission, (1999), ISBN 92 828 6655 6.
- [12] ICRP draft recommendation 02/276/06, (5 June 2006).
- [13] Chałupnik S., Michalik B., Wysocka M., Skubacz K., Mielnikow A., Contamination of settling ponds and rivers as a result of discharge of radium - bearing waters from Polish coal mines. *Journal of Environmental Radioactivity*. 54 (2001) 85-98.
- [14] Michalik B. „*Environmental pollution caused by natural radioactivity occurring in mining industry – the scale of the problem*” Sustainable Post-Mining Land Management, Edited by: Euromines, CBPM CUPRUM Wrocław and Mineral and Energy Economy Research Institute Polish Academy of Science, Kraków, ISBN 83-906885-9-Y, Wrocław (2004), page: 145-154.
- [15] Michalik B. Wysocka M., Chałupnik S., Skubacz K., Mielnikow A., Trząski L., *Contamination Caused by Radium Discharged with Mine Effluents into Inland Waters*, Radioprotection, Volume 40, Suppl.1 (2005), p. 503-509
- [16] RUSSIAN INSTITUTE OF AGRICULTURAL RADIOLOGY AND AGROECOLOGY, REPORT ON THE PROJECT: Genotoxicity assay of soil and water samples from Upper Silesia post-mining areas by means of *Allium*-test, Obninsk, (2005).
- [17] Bunzl, K., Kertner, R., Scharamel, P., Szele, M., Winkler, R., Speciation of <sup>238</sup>U. <sup>226</sup>Ra. <sup>210</sup>Pb. and stable Pb in the soil near an exhaust ventilating shaft of a uranium mine *Geoderma* 67 (1995) 45-53.
- [18] Tessier, A., Campbell, P.G.C., Bisson, M., Sequential extraction procedure for the speciation of particulate traces metal. *Anal. Chem.*, vol. 51 (1979) 844-855



# Fractionation of $^{226}\text{Ra}$ and $^{228}\text{Ra}$ in waste material of coal mines and coal fired power plants and the effect of speciation on plant uptake

E. Bokori<sup>a</sup>, B. Michalik<sup>b</sup>, L. Juhász<sup>a</sup>, G. Trabidou<sup>c</sup>, Iz. Chmielewska<sup>b</sup>

<sup>a</sup> National Research Institute for Radiobiology and Radiohygiene.  
Budapest. Hungary

<sup>b</sup> Central Mining Institute.  
Katowice. Poland

<sup>c</sup> Environmental Radioactivity Laboratory. INT\_RP. NCSR "Demokritos".  
Athens. Greece

**Abstract.** The potential radiological risk of contaminated areas by enhanced level of natural occurring radionuclides is depend on chemical and ecological behavior of these radionuclides. Fractionation is a proper method to determine the mobility of radionuclides which is assumed closely related to bioavailability and uptake by biota. In the present work four different areas were investigated. Sites which are located in Upper Silesia have been used for discharging of pit water. Sites in Hungary are used as a deposit of waste material from coal fired power plants. Because the  $^{226}\text{Ra}$  and  $^{228}\text{Ra}$  are the most prominent radionuclides among the potential contaminants around mining sites and waste deposit, our research was focused on investigation the behavior of Ra. The level of  $^{226}\text{Ra}$  activity-concentration in sediment samples from the regions of Upper Silesia is varied between 0.5-25 kBq/kg and the level in ash samples from Hungarian sites changes in a range of 0.20-3.30 kBq/kg. The paper summarized two studies. The first investigation has concerned to the determination of mobility of radionuclides in waste materials. The second study is dealing with plant uptake of  $^{226}\text{Ra}$  and  $^{228}\text{Ra}$  and the determination of site specific concentration factors on these areas. Different sequential extraction procedures were applied to investigate the speciation of radium. The ratio of radium was determined in "water" fraction, "readily exchangeable" fraction, in the "bound to carbonate" fraction and in the "bound to Fe and Mn oxide" fraction respectively. To calculate a realistic CR for  $^{226}\text{Ra}$  and  $^{228}\text{Ra}$  we take into account mobility of radionuclides. CR values were calculated on base of dry matters of sampled natural vegetation. The value of CR for the Ra on sites of depository in Hungary and on the settling ponds in Poland varied between (0.05– 2.4), (0.06- 51.0) respectively due to the mobile fraction.

## 1. Introduction

The TENORM type waste produced by non-nuclear industrial activities as mineral production, mining activities or coal fired power plants contain a number of long lived natural occurring radionuclides from the U and Th decay series with an enhanced level concentration.

As a result of the lack of appropriate legislation such waste have been often dumped into the environment without any regard to radiation protection requirements. First of all it results enhanced exposition to external radiation hence accurate measure of the total radionuclide concentration in these waste materials are required to asses the potential radiological risk at a dump site [1, 2]. However if one managed to gather data about physical presence of each particular radionuclides this information would give only a part of the knowledge necessary to evaluate its harmful potential. The radiological hazards can be increased by migration process of mobile fraction of these radionuclides to the vicinity of a depository. [3] Being released into the ecosystem they can enhanced the internal doses to biota. That is the reason why it is crucial to know the mobility of radionuclides [4]. The mobility and ecological behavior of every element depend on their speciation in certain waste material[5]. The speciation of radionuclide is generally related to its physico-chemical forms existing i.e. simple and complex ion in interstitial solution, exchangeable ions associated with waste material organic fractions; occluded or co-precipitated with metal oxides, carbonates, sulphates and other secondary minerals [6]. Basing on the consideration of the elements being in association with different chemical phase of waste matters, single and multiply sequential analysis to determined of there speciation had been developed [7-9]. Among this extraction procedure the most widely applied methods were recommended by Tessier [10] and by Community Bureau of Reference that issued standard procedures to determine the speciation in solid matter [11]. Since the migration and accumulation of

mobile part of contaminants in the soil plant system are complex processes therefore in assessment models a soil plant concentration ratio is used (is referred as the concentration factor - CR) to estimate the transportation of radionuclide through the food chain and to determine the biota internal dose [12, 13]. In TENORM type waste radium is the most prominent radionuclide and usually it and its daughters is the most important contributor to the related hazard [4]. For that reason this work was focused on radium to determine its mobility and plant uptake.

To determine of mobile fraction of  $^{226}\text{Ra}$  and  $^{228}\text{Ra}$  in the investigated waste materials different extraction procedures have been applied. Basing on results of leaching tests and mass activity concentration in the collected plants site specific concentration factors were calculated.

## **2. Samples and methods**

### ***2.1. Investigated sites***

Four different sites have been selected to investigate the behavior of radium isotopes in the TENORM type waste. All of them are or were used as depository for waste. Two of them are situated at Upper Silesian Coal Basin (USCB) territory, Poland. These settling ponds had been used for temporary retention of pit water before discharging into the inland water. They contain settled sediment and scales with high radium activity concentration. Since both of them have been abandoned for few years one, Bojsowy, is already dried out and the sediment get up to the surface. Rontok, the second settling pond is still filled with fresh water which shields the vicinity from the external radiation emitted from the bottoms. But the radium activity concentration in surface soil close to the discharging pipe's outlet contaminated by scale is extremely high. [14,15]

Two selected Hungarian territories are used as a depository of waste matters produced by coal fired plants. About 10 million tons of bottom ash and slag have been piled up on each waste dump. The previous investigations dealing with determination of radioactivity level in coal mining industry and coal fired power plants' vicinity, showed that the  $^{226}\text{Ra}$  activity concentration in coal from one site (Ajka power plant) exceeded about a factor of 10 the natural activity content of coal from other areas [1]. Identification of sampling site sampling points and samples is given in the Table 1.

### ***2.2. Sampling and sample processing***

In Poland on the surface of Bojsowy and Rontok ponds 9 and 3 different points were selected respectively. Each sampling points was characterized by different ambient dose rate. Samples were taken from the surface layer with 20 cm thicknesses. The natural vegetations were collected from each of selected points. One coal ash sample and two different plants were taken on both Hungarian areas.

First of all samples were dried out at room temperature and after that at 90 °C, until constant weight. After drying, from the sample the grains exceeding 1.25 mm in diameter were removed. Representative, homogenized and sieved aliquots were taken from the original bulk to the extraction procedure and activity concentration measurements. Fresh plant samples were washed to remove possible sediment and ash pollution from the surface of plant. After that samples were dried out and cut into small pieces for activity concentration measurements.

### ***2.3. Measurements***

Initial specific mass activities of radium isotopes in every sample were measured by high resolution HPGe gamma-spectrometry. For spectrum analysis the GENIE 2000 software was used. The energy and efficiency calibration was carried out on base of Rg-U and Rg-Th, the IAEA standards. The detection limit was 1 Bq/kg for  $^{226}\text{Ra}$ , the given uncertainty quotes to 1-sigma reliability. The radium isotopes were measured directly ( $^{226}\text{R}$ ) or by there progenies after equilibrium had been reached in Marinelli beaker. The results are given in Bq/kg of dry mass.

TABLE 1. SAMPLING SITES AND SAMPLES IDENTIFICATION

Sampling site description	Code	Solid samples	Plant samples	Ambient dose rate at ground level ( $\mu\text{Sv/h}$ )
<b>Bojsowly</b>				
on surface of settling pond	B1-B6	sediment	Common reed ( <i>Phragmites australias</i> )	0.40-4.0
	B7	sediment	Papperweed ( <i>Lepidium ruderale</i> )	0.68
	B10	sediment	Bull Thistle ( <i>Cirsium vulgare</i> )	0.47
	B11	sediment	Scentless Chamomile ( <i>Matricaria Perforate</i> )	0.50
<b>Rontok</b>				
next to the discharging pipe	R1	soil/scale	Whie birch ( <i>Betula pendula</i> )	11.0
	R3	soil/scale	Reed grass ( <i>Calamagrostis epigejos</i> )	3.0
settling pond	R8	sediment	Common reed ( <i>Phragmites australias</i> )	-
<b>Ajka</b>				
bank of tailing pond	A1	coal ash	Reed grass ( <i>Calamagrostis epigejos</i> ) Pine ( <i>Pimus sylvestris</i> )	0.50
<b>Pécs</b>				
on surface of pile	P1	coal ash	Common reed ( <i>Phragmites australias</i> ) Willow ( <i>salix acutifolia</i> )	0.25

Activity of  $^{226}\text{Ra}$  and  $^{228}\text{Ra}$  in the extract from sediment and ash were determined after chemical separation through barium sulfate precipitation. The samples for measurement were prepared by using LIMAGEL scintillation cocktail. Samples were measured by Liquid Scintillation Counter (LSC) with simultaneous analysis of  $^{226}\text{Ra}$  and  $^{228}\text{Ra}$  [16].

#### 2.4. Sequential extraction procedure

Three sequential extraction procedures were applied to determine of mobile fraction of natural radionuclides in the investigated samples. These methods are detailed in Table 2, and 3. Four samples were selected to fractionation procedure, one sample from each site was chosen by the highest activity. 100g aliquots were taken from homogenized samples to the extractions.

The amount of radionuclides remaining in residual fraction can usually be considered at least to a first approximation as immobile, environmentally non-reactive.

The applied third method (*Method 3.*) was only a simple one-step extraction using 1 M ammonium-acetate solution to determine the changeable and soluble proportion of the radionuclides in samples. The mobile part which was obtained from ammonium-acetate leaching can be considered as the available amount of radionuclide for a plant. [18]

TABLE 2. MODIFIED TESSIER (1979) METHOD BY BUNZL FOR DETERMINE THE AVAILABLE FRACTION (*Method 1*. Sample reagent ratio 1:8)

Phase	Reagent	Procedure (temperature, time)
<i>Fr. 1.</i> Readily exchangeable cations	1 M MgCl <sub>2</sub> pH 7	At room temperature, for 1 h
<i>Fr. 2.</i> Bound to carbonate	1 M CH <sub>3</sub> COONa	At room temperature, for 5 h
<i>Fr. 3.</i> Bound to Fe-Mn oxide	0 .04 M NH <sub>2</sub> OH* HCl	At 85-95 °C, for 6h
Residual (immobile fraction)		

TABLE 3. METHOD ACCORDING BCR [17] (*Method 2*. Sample reagent ratio 1:20)

Phase	Reagent	Procedure (temperature, time)
<i>Fr. 1.</i> Water soluble, readily exchangeable, carbonate bound	0.1 M CH <sub>3</sub> COOH	At room temperature, for 16 h
<i>Fr. 2.</i> Bound to Fe-Mn oxide	0 .04 M NH <sub>2</sub> OH* HCl	At room temperature, for 16 h
<i>Fr. 3.</i> OM and sulfide bound	30% H <sub>2</sub> O <sub>2</sub> and 1M NH <sub>3</sub> Ac	At room temperature, for 1 h, at 85 °C for 1 h, after that add NH <sub>3</sub> Ac for 16 h
Residual (immobile fraction)		

### 3. Results and discussion

#### 3.1 Total activity concentration in scale sediment and ash

The total activity concentration of <sup>226</sup>Ra and <sup>228</sup>Ra in solid samples at four locations are given in Table 4. Among the collected samples the radium activity concentration was far highest at Rontok site on the (R3) point. The smallest concentration was found in the ash from Pécs. The ratio between the sampling point with the largest and smallest concentration is about 120. The ratio between Hungarian ash samples from Pécs and Ajka for <sup>226</sup>Ra and <sup>228</sup>Ra are about 15.6 and 0.21 respectively. The ranges of total Ra activity concentration in different samples are (0.7-12) kBq/kg at Bojsowoy (1.8-39) kBq/kg at Rontok (0.36-3.25) kBq/kg at Hungarian sites.

TABLE 4. <sup>226</sup>Ra AND <sup>228</sup>Ra TOTAL ACTIVITY CONCENTRATION IN SAMPLES FROM FOUR LOCATIONS

site	code	activity concentration (Bq/kg)	
		<sup>226</sup> Ra	<sup>228</sup> Ra
Bojsowoy	B1–B6	(666 – 5768)	(389 – 6218)
	B7	998	958
	B10	423	293
	B11	720	418
Rontok	R1	1079	720
	R3	24960	13698
	R8	3160	1482
Ajka	A1	3220	34
Pécs	P1	206	159

#### 3.2 Results of fractionation

Results from fractional analysis done by three various methods in four different samples are given in the Table 5.

TABLE 5.  $^{226}\text{R}$  AND  $^{228}\text{Ra}$  ACTIVITY CONCENTRATION RESULTS OF SEQUENTIAL EXTRACTION CARRIED OUT BY THREE VARIOUS METHODS

	Rontok R3		Bojsowi B1		Ajka		Pécs	
	$^{226}\text{Ra}$	$^{228}\text{Ra}$	$^{226}\text{Ra}$	$^{228}\text{Ra}$	$^{226}\text{Ra}$	$^{228}\text{Ra}$	$^{226}\text{Ra}$	$^{228}\text{Ra}$
Method 1.								
Fr. 1	8.5	5.4	1.95	1.11	6.5	0.63	1.71	1.05
Fr. 2	13.2	8.5	1.42	1.18	28.1	<0.1	0.97	0.71
Fr. 3	2.9	1.5	1.82	1.43	7.86	<0.1	3.35	1.88
mobile fraction	24.6	15.4	5.2	3.7	42.5	0.83	6.03	3.64
Total	24960	13698	5768	6218	3220	34	206	159
mobile ratio%	0.10	0.10	0.09	0.06	1.3	2.4	2.9	2.3
Method 2.								
Fr. 1	2.9	2.3	1.5	0.9	6.5	<0.2	0.61	0.4
Fr. 2	6.5	6.8	5.3	5.3	82	<0.5	1.89	1.2
Fr. 3	<0.1	9.6	12.5	8.5	118.6	7.3	1.34	0.8
mobile fraction	9.5	18.7	19.3	14.7	206.5	8.0	3.84	2.4
Total	24960	13698	5768	6218	3220	34	206	159
mobile ratio%	0.04	0.14	0.33	0.23	6.4	23.5	1.9	1.5
Method 3.								
Fr. 1	8.2	11.3	5.1	4.14	74.4	6.1	1.6	1.2
Total	24960	13698	5768	6218	3220	34	206	159
mobile ratio%	0.03	0.08	0.09	0.07	2.3	18.0	0.78	0.75

Percentage of the radium mobile fractions was calculated with taking its activity concentration in the unfractionated sediments as 100%. Mobile part of Ra was calculated for each (1-3) fraction of extraction procedures. It can be seen clearly from extractable activity concentrations and percentage amounts of  $^{226}\text{R}$  and  $^{228}\text{Ra}$  that the mobile fraction of these radionuclides is very low in each of investigated samples. The mobile part is less than 0.35% of initial activity concentration in case of both sediments from Poland. In Hungarian samples it is higher with about one order of magnitude. The range of mobile part in the ash sample from Pécs lies between 0.7%-2.9%. In case of Ajka ash the range of mobile ratio of  $^{226}\text{Ra}$  and  $^{228}\text{Ra}$  are between 1.3%-6.4% and 2.4%-21.5% respectively. Results show that the Ra mainly associated with residual fraction all but in case of  $^{228}\text{Ra}$  in Ajka ash. This implies that the main process of Ra incorporation into the sediment is a precipitation with the sulphate content of water or substitution in barium sulphate precipitate creating a form of  $[\text{Ba}(\text{Ra})\text{SO}_4]$  which is called radiobaryte, characterized by very low solubility. In coal combustion products (ash, slag and sludge) radionuclides are concentrated as sulphate, phosphate or other secondary mineral form.

Since the higher extractable amounts were measured in Fr.2 and Fr. 3 it indicates some bounding with amorphous ferromanganese oxyhydroxides or sulphides. The amount of mobile part given by the three extraction method doesn't show significant differences in the investigated sediment samples. Only the results from BCR method show slightly enhanced value in comparison to the others. The ratio of mobile part of  $^{226}\text{Ra}$  and  $^{228}\text{Ra}$  determined by BCR method in ash sample from Ajka indicates higher leaching with a factor of 4 and 9 respectively to the other methods.

### 3.3. Ra concentration ratio (CR) in natural vegetation

The Ra concentration factor for natural vegetation has been calculated on the basis of total and mobile part of radium in waste. The ratio of dry weight activity concentration in plant (Bq/kg) to dry weight activity concentration in soil (Bq/kg) gives the value of CR. The mobile part in sediment and ash used for CR calculation was determined by ammonium-acetate extraction method.

Soil/plant CRs obtained for the plants are given in Tables 6 and 7. The range of CR values calculated from total Ra activity concentration at the investigated sites are (0.006-0.071), (0.013-0.078), (0.014-0.018), (0.001-0.079) respectively.

TABLE 6. RADIUM CR VALUES FOR NATURAL VEGETATION AT RONTOK AND BOJSOWY SETTLING PONDS

	CR (from total Ra)			CR (from mobile fraction)		
	<sup>226</sup> Ra	<sup>228</sup> Ra	<sup>226+228</sup> Ra	<sup>226</sup> Ra	<sup>228</sup> Ra	<sup>226+228</sup> Ra
<b>Rontok</b>						
White birch	0.010	0.011	0.010	51.2	0.42	4.60
Reed grass	0.071	0.010	0.047	30.9	13.0	20.6
Common reed	0.014	0.006	0.012	37.5	18.2	31.8
<b>Bojsowy</b>						
Bull Thistle	0.020	0.013	0.017	0.13	0.10	0.11
Papperweed	0.072	0.052	0.078	0.19	0.12	0.16
Scentless Chamomile	0.056	0.043	0.021	0.25	0.10	0.16

TABLE 7. RADIUM CR VALUES FOR NATURAL VEGETATION AT PÉCS AND AJKA WASTE DEPOSITORIES.

	CR (from total Ra)			CR (from mobile fraction)		
	<sup>226</sup> Ra	<sup>228</sup> Ra	<sup>226+228</sup> Ra	<sup>226</sup> Ra	<sup>228</sup> Ra	<sup>226+228</sup> Ra
<b>Pécs</b>						
Common reed	0.017	0.018	0.017	2.20	2.38	2.28
Willow	0.016	0.014	0.015	2.11	1.88	2.01
<b>Ajka</b>						
Reed grass	0.006	0.033	0.006	0.24	0.18	0.24
Pine	0.001	0.079	0.002	0.05	0.44	0.08

The CR values based on mobile fraction are higher by a factor of (10-1000), to those CR which was calculated based on total radium concentration. The highest difference exists in case of R3 point at Rontok place. For this site CR value from mobile part is 1000 times high as the CR value calculated from total activity. In the Hungarian areas CR values from mobile fraction lie between 0.05 and 2.38. The radium uptake is relatively higher on that place where the available fraction is very low (i.e. at Rontok). There are some differences in uptake of reed grass and pine at Ajka site and white birch at Rontok place, otherwise the results show high similarity at the same place. It implies that the process of plant uptake is determined by the available amount of radionuclides and the metabolic process play only the second role in the uptake at this range.

In order to find how the plant's metabolic processes influence the radium uptake at the Bojsowy pond 6 samples of common reed were taken. Each sampling point was characterized with different dose rate so the total Ra activity concentration varied between 1100 and 12500 Bq/kg. We determined the mobile fractions for each samples (by method 3). Based on the total and mobile fraction CRs were calculated for each plant samples. Value of CRs is given in Table 8. The difference between the largest and smallest value of CR based total and mobile fraction is about three orders of magnitude. Figure 1 shows the relationship between the total and mobile parts of Ra in sediment and the CR value based on total and mobile concentration in sediment. We can conclude that the relation between the sediment concentration and CR value is exponential.

TABLE 8. BASIC STATISTICS OF CR VALUE CALCULATED FOR COMMON REED AT DIFFERENT POINTS ON THE BOJSOWY POND

Plants		CR (from total Ra)			CR (from mobile fraction )		
		<sup>226</sup> Ra	<sup>228</sup> Ra	<sup>226+228</sup> Ra	<sup>226</sup> Ra	<sup>228</sup> Ra	<sup>226+228</sup> Ra
Common reed	min	0.003	0.003	0.003	0.10	0.06	0.09
Number of	max	0.45	0.029	0.059	3.15	4.59	3.79
sample:7	average	0.021	0.014	0.021	1.11	1.09	1.10

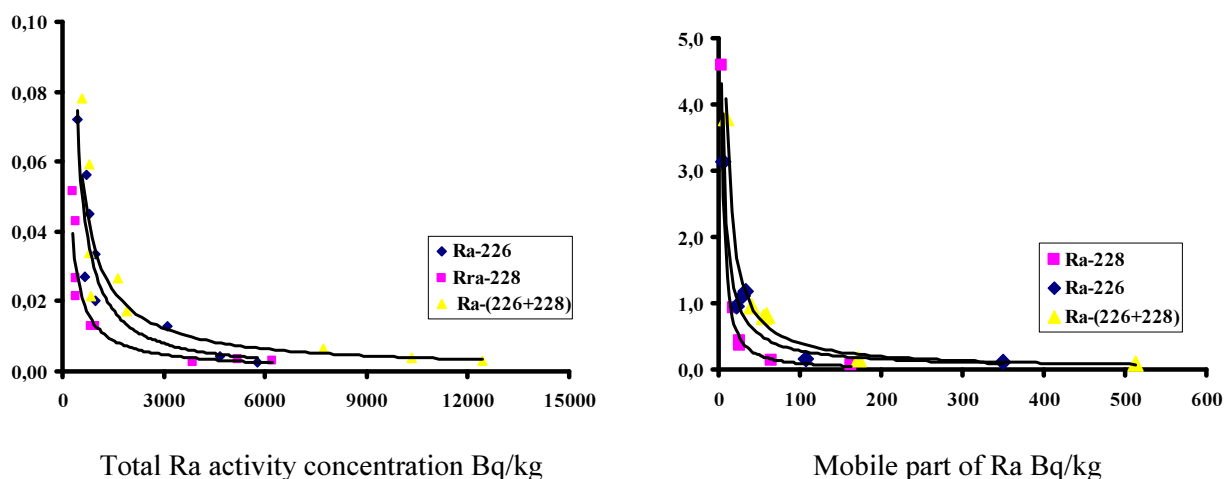

FIG. 1. Relationships between the total and mobile radium concentration of sediment and CR values based on total and mobile part of radium.

#### 4. Conclusion

Results from fractionation study shows that the mobile, extractable fraction is very low in both of investigated medium.

The amount of mobile fraction is less about a factor of 10 to 1000 than the total radium concentration. At such level of the radium activity concentration, results from different extraction methods don't show significant differences in proportion of mobile part.

It wasn't possible notice any remarkable differences of CRs value between different 8 species of plant except of pine. This implies that the plants' uptake depends on amount of the mobile radium in waste.

For the same species of plant the relationship between the radium activity concentration in sediment and sediment/plant CR is exponential. It suggests that the plants' intake of radium is limited by their metabolism.

#### ACKNOWLEDGEMENT

The investigation presented in this study were carried out within the frame of the EU-Project "WaterNORM and of European Commission's Marie Curie Host fellowships Program. No. MTKD-CT-2004-003163.

## REFERENCES

- [1] Szerbin, P., Juhász, L., Csige, I., Várhegyi, A., Vincze, J., Szabó, T., Maringer, F-J., TENORM's around coal fired power plant tailings ponds in Hungary, International Congress Series (2005)1276:365-366, 2005.
- [2] INTERNATIONAL ATOMIC ENERGY AGENCY Generic model for use in assessing the impact of discharges of radioactive substances to the environment. Safety Reports Series No. 19. IAEA. Vienna (2001)
- [3] Sheppard, S.C., Sheppard. M.I., Ilian. M., Thompson. P., soil to plant transfers of uranium series radionuclides in natural and contaminated settings. Radioprotection. vol 40 (2005) 5253-5259
- [4] Matinez-Aguirre, A., Garcia-León, M., Ivanovich. M., u and the separation in river sediment. The Science of the Total Environment 173/174 (1995) 203-209
- [5] Zhongwen, W., Xiao-quan, S., Shuzhen, Z., Comparison between fractionation and bioavailability of trace elements in rhizosphere and bulk soils. Chemosphere 46. (2002) 1163-1171
- [6] Kot, A., Namiesni, J., The role of speciation in analytical chemistry Trends in analytical chemistry. vol 19. nos 2+3 (2000) 69
- [7] Blanco, P., Tomé, F.V., Lozano, J.C., Fraction of natural radionuclides in soils from a uranium mineralized area in the south-west of Spain. J. Environ. Radioactivity 79, issue 3 (2005) 315-330
- [8] Bunzl, K., Kertner, R., Scharamel, P., Szele, M., Winkler, R., Speciation of  $^{238}\text{U}$ ,  $^{226}\text{Ra}$ ,  $^{210}\text{Pb}$ . and stablePb in the soil near an exhaust ventilating shaft of a uranium mine Geoderma 67 (1995) 45-53
- [9] Szabó, Gy., Guczi, J., Nisbet, A., Investigation of solid phase speciation of  $^{90}\text{Sr}$ ,  $^{137}\text{Cs}$ ,  $^{239}\text{Pu}$ ,  $^{241}\text{Am}$ , in soils determined by extraction and ultra-filtration methods.
- [10] Tessier, A., Campbell, P.G.C., Bisson, M., Sequential extraction procedure for the speciation of particulate traces metal. Anal. Chem., vol. 51 (1979) 844-855
- [11] Schultz, et. al. Evaluation of sequential extraction method for determining actinide fractionation in soil and sediments. J. Environ. Radioactivity vol. 40 (1998) 155-174
- [12] Pulhani, V. A., Dafauti, S., Hegde, A. G., Sharma, R. M., Mishra, U. C., Uptake and distribution of natural radioactivity in wheat plants from soil J. Environ. Radioactivity 79 (2005) 331-346
- [13] Chen, S.B., Zhu, Y.G., Hu., Q.H. Sol to plant transfer of  $^{238}\text{U}$ ,  $^{226}\text{Ra}$  and  $^{232}\text{Th}$  on a uranium mining-impacted soil from southeastern China. J. Environ. Radioactivity 82 (2005) 223-236
- [14] Michalik B., Chałupnik S., Wysocka M., Skubacz K., Ecological problems of the coal industry and the ways to solve them., J. Min. Sci. 38(6), 2002.
- [15] Chałupnik S., Michalik B., Wysocka M., Skubacz K., Mielnikow A., Contamination of settling ponds and rivers as a result of discharge of radium - bearing waters from Polish coal mines. Journal of Environmental Radioactivity. 54 (2001) 85-98.
- [16] Chałupnik, S., Lebecka, J., Mielnikow, A., and Michalik, B., Determining radium in water : comparison of methods-Liquid Scintillation Spectrometry 1994, edited by G.T. Cook, D.D. Harkness, A.B. MacKenzie, B.F. Miller and E.M. Scott. RADIOCARBON 1996, p. 103 - 109-1994
- [17] Ure, et al., Speciation of heavy metals in soils and sediment. An account of the improvement and harmonization of extraction techniques undertaken under the auspices of BCR of the Commission of the European Communities. Int. J. Environ. Anal. Chem.. vol. 51. (1993). 135-151.
- [18] Khatir Sam, A., Eriksso, A., Radium-226 uptake by vegetation grown in western Sudan J. Environ. Radioactivity, Vol 29 no. 1. (1995) 27-38



## Natural radioactivity status in mining settling ponds: Bioaccumulation of Radium in biota and the derived dose\*

G. Travidou<sup>a</sup>, B. Michalik<sup>b</sup>, Ed. Bokori<sup>c</sup>, Iz. Chmielewska<sup>b</sup>

<sup>a</sup>Environmental Radioactivity Laboratory,  
INT\_RP, NCSR "Demokritos",  
Athens, Greece

<sup>b</sup>Laboratory of Radiometry,  
Central Mining Institute,  
Katowice, Poland

<sup>c</sup>National Center of Public Health,  
National Research Institute for Radiobiology and Radiohygiene,  
Budapest, Hungary

A radiological survey has been carried out in two mining settling ponds in Upper Silesia in Poland based on natural radionuclide inventory in abiotic environment and the consequent dose rate assessment for representative species of biota. The distribution of natural radionuclides in the two mining settling ponds was studied in relation to the abiotic environment and the biotic environment interaction. More specific, the study was focused at the abandoned settling ponds of Rontok and Bojszowy, characterized by the presence of high salinity levels and enhanced Radium concentrations, in comparison with the wide Polish territory.

To evaluate the environmental radiation levels in the studies areas, samples of soil, sediment, water and biota were appropriately collected and analyzed by gamma spectrometry and liquid scintillation counter at the Laboratory of Radiometry and the activity concentrations of the collected samples of the natural radionuclides <sup>226</sup>Ra, <sup>228</sup>Ra and <sup>40</sup>K were determined. The methodologies used for laboratory measurements were described in detail in [1].

The levels of <sup>226</sup>Ra and <sup>228</sup>Ra in water and sediment samples from the studied mining settling ponds were found to be significantly elevated, due to the discharge of radium-bearing waters into them. The activity concentrations in Rontok sediment samples were in the range of 1.0 - 25 kBq.kg<sup>-1</sup> and 1.5 - 14 kBq.kg<sup>-1</sup> for <sup>226</sup>Ra and <sup>228</sup>Ra, respectively, compared with the ranges of 0.4 – 6 kBq.kg<sup>-1</sup> and 0.3 – 6.2 kBq.kg<sup>-1</sup> for Bojszowy area.

The selected herbaceous vegetation samples were as follows: *Calamagrostis epigeios*, *Cirsium vulgare*, *Lepidium ruderales*, *Matricaria perforata* and *Phragmites australis*. It is noteworthy that most of the above mentioned plants present among their habitats waste places, also. The selected tree samples were *Betula pendula* and *Quercus robur*. The activity concentrations (wet weight) in Rontok biotic samples were in the range of 31 – 173 Bq.kg<sup>-1</sup>, 5 -101 Bq.kg<sup>-1</sup> and 238 – 320 Bq.kg<sup>-1</sup> for <sup>226</sup>Ra, <sup>228</sup>Ra and <sup>40</sup>K, respectively, compared with the ranges of 11 – 27 Bq.kg<sup>-1</sup>, 7 – 13 Bq.kg<sup>-1</sup> and 306 - 903 Bq.kg<sup>-1</sup> for Bojszowy area.

---

\*Work performed within the framework of the European Commission's Marie Curie Host Fellowships Programme, No MTKD-CT-2004-003163.

In terms of pathway exposure to biota, internal and external dose rates calculations were carried out to assess the radiological impact in the biotic environment due to  $^{226}\text{Ra}$ ,  $^{228}\text{Ra}$  and  $^{40}\text{K}$  radiations. The external dose rates ( $\mu\text{Gy d}^{-1}$ ) were estimated on the basis of the habitat of the exposed organisms for root and upper part plant systems [2,3] while as the internal dose rates were estimated considering biota as generic [3]. In some cases dose rate calculations were performed by using the FASSET project dose conversion factors for reference organisms relevant to different exposure situations [4].

The internal dose rates were in the range of  $3.9 - 16.6 \mu\text{Gy d}^{-1}$ . The fluctuations of external dose rates were very high ( $10.6 - 793 \mu\text{Gy d}^{-1}$ ). For a better estimation of the effects on the biotic components of the studied areas due to exposure to the environmental radiation, the conceptual model by Polikarpov is employed [5]. According to this model, most of the dose rate values were within the “physiological masking zone” ( $14 - 140 \mu\text{Gy d}^{-1}$ ) and “ecological masking zone” ( $140 - 10000 \mu\text{Gy d}^{-1}$ ). The lower external dose rates were in the areas of overlap between minor radiation effects and natural variability in physiological function. The maximum external dose rates were found to be within the ecological masking zone levels, where effects of radiation at the population level can be detected. Based on our results and in response to radioprotection of the natural environment, further investigation and appropriate remedies should be applied.

## REFERENCES

- [1] BOKORI E. et al. Fractionation of  $^{226}\text{Ra}$  and  $^{228}\text{Ra}$  in waste material of coal mine and fired power plant and the effect of speciation on plant uptake. NORM V Conference 2007 (in preparation).
- [2] TRABIDOU G., Radiological study in areas around radioactive springs. Ph. D. Thesis, University of Athens (2004).
- [3] AMIRO B. D. Radiological Dose Conversion Factors for Generic Non-Human Biota Used for Screening Potential Ecological Impacts. J. Environ. Radioactivity 35(1):37-51 (1997).
- [4] FASSET (2003). FASSET Deliverable 3. Dosimetric models and data for assessing radiation exposures to biota (June 2003).
- [5] POLIKARPOV G. Conceptual model of responses of organisms, populations and ecosystems to all possible dose rates of ionizing radiation in the environment. Rad. Prot. Dos. Vol. 75, Nos 1-4, pp.181-185 (1998).

# Bioindication-based approach on integrated assessment of natural radionuclides impact on biota in post-mining areas

S. Geras'kin<sup>a</sup>, B. Michalik<sup>b</sup>, N. Dikareva<sup>a</sup>, A. Oudalova<sup>a</sup>, S. Chalupnik<sup>b</sup>, V. Dikarev<sup>a</sup>, M. Wysocka<sup>b</sup>

<sup>a</sup> Russian Institute of Agricultural Radiology and Agroecology,  
Obninsk, Russia

<sup>b</sup> Central Mining Institute,  
Katowice, Poland

**Abstract.** Post-mining areas are of special concern as being polluted by mixture of natural radionuclides, heavy metals and saline waste water, which may enhance a risk both for human health and biological components of natural ecosystems. The study was aimed at developing a complex approach for the environment health assessment integrating information on contaminants levels registered with routine techniques and bioindication-based estimates of adverse effects of their combination. Water and sediment soil were sampled from underground galleries of collieries and a river and ponds in post-mining areas of the Upper Silesia, Poland. Measurements of chemicals and radionuclides composition in water and soil samples were carried out. Phyto- and genotoxicity of sampled water and soil were assessed with *Allium cepa* plant system application. Cytogenetic and cytotoxic effects were used as biological endpoints, namely, frequency and spectrum of chromosome aberrations and mitotic abnormalities in ana-telophase cells as well as mitotic activity in *Allium* root tips. Compatibility of findings observed and legislative standards adopted for these main factors are discussed. Complex issues are involved in evaluating environmental risk, and an effective linking of bioindication screening assays to the well-established environmental pollution monitoring approach is a way of improving and upgrading an existing system of the public and environment protection to meet requirements of consistency between nowadays scientific knowledge and decision-making process.

## 1. Introduction

While many researches are focused on areas with radioecological problems like the Chernobyl zone, the Techa river region in the South Urals, Russia, or the Semipalatinsk Nuclear Test Site, Kazakhstan, the similar impact in post-mining areas with enhanced levels of natural radioactivity is far less known. Such areas are located, for example, in the Komi Republic and Yakutia, Russia as well as in the Upper Silesia, Poland. They are of special concern as being polluted by mixture of natural radionuclides, heavy metals and saline waste water, resulting in relatively high contamination levels. This makes many ecosystem components undergo a simultaneous potential stress from chemical and radioactive toxicants. Heavy metals and heavy natural radionuclides are both distributed very irregularly in ecosystem compartments. Such elements may accumulate in certain food chains and eventually reach concentrations capable to produce toxic or genotoxic effects. Contemporary levels of persistent pollutants in post-mining areas may enhance a risk both for human health and to biological components of natural ecosystems, therefore, a clear understanding of all these hazards are needed.

Many efforts have been undertaken to develop effective methods for assessing the quality of the environment. Generally, two approaches are used. The more classical one is to take samples of air, water and soil and analyze them in laboratory using routine chemical-physical techniques. An evaluation of genuine exposure characteristics is complicated, however, because the whole list of mutagens involved should be recognized in advance, since most quantification techniques are able of registering only an assigned specific compound or its metabolites. Consequently, even exhaustive information on exposures in contaminated sites gives only a part of the knowledge necessary to evaluate and assess the harmful potential of pollutants for organisms and communities.

The other approach is to score biological effects in standard indicator species. Plant systems seem especially well suited [1] for environmental monitoring. Plant bioassays provide meaningful parameters to assess the toxicity of complex mixtures like industrial wastes [2] even without knowledge of its chemical composition. In contrast to the specific nature of assessments on exposure, studies of biological effects integrate the impacts of all the harmful agents, including synergistic and

antagonistic effects. This approach is particularly useful for assessing unknown contaminants, complex mixtures, or hazardous wastes. Thus, a correct estimation of the environment pollution risk needs to be derived from biological tests and pollutant chemical control in ecosystem compartments. Both need to be carried out simultaneously. Hence, the simultaneous use of chemical and biological control methods allows an identification of the relationships between the pollutant concentrations and the biological effects that they cause. In turn, such relationships may allow identifying the contribution of each specific pollutant to the overall biological effect observed. The knowledge generated makes it possible to limit the action of unfavorable factors on biota and to predict the further ecological alterations in regions submitted to intensive industrial impact.

Interaction of contaminants with biota takes place firstly at the cellular level. It is not only the first manifestation of harmful effects, but also suitable tools for an early and sensitive detection of the risk. Therefore, just genetic test-systems should be used for an early and reliable monitoring of the alterations resulting from the human activity. The present work is focused on: 1) evaluating and comparing the genotoxic potential of two environmental compartments (water and sediment) by employing root meristem cells of *Allium cepa*; 2) finding out biological markers that are simple to be scanned and linked to important toxicants concentrations in water and sediment samples from post-mining areas.

## **2. Materials and methods**

A standard test for toxicity should be easy to perform and the results should be rapidly obtained and reproducible. In our study, *Allium cepa* bulbs were used. A cell cycle duration and sensitivity to many widespread mutagen agents are both well-known for *A. cepa* cells [3, 4]. Observation of the root tip system constitutes a rapid and sensitive method for environmental monitoring. Among the test systems suitable for toxicity monitoring, the *Allium*-test is well known and commonly used in many laboratories. Results from the *Allium*-test have shown good agreement [5] with findings from other test-systems, eukaryotic as well as prokaryotic. Generally speaking, the *Allium*-test is a very useful tool for evaluating and ranking environmental chemicals with reference to their toxicity.

### **2.1. Sampling**

Water samples were collected in April 2005 in the Upper Silesia post-mining areas, Poland from underground galleries of Chwalowice (W1), Zory (W2) and Ziemowit (W3) collieries, from the Gostynka River near the Bojszowy settling pond (W4) and in the Rontok settling pond vicinity (WRef, reference site). As an additional control, distilled water (DW) was used, which was proved in more detail in our previous study [6].

Sediment samples were collected in April 2005 from the bank of the Rontok settling pond (S1), bottom of the Bojszowy settling pond (S2 and S3) and underground galleries (S4). All sediment samples were taken by “the envelop” method (taking samples from four corners and from the centre of a plot, pooling and mixing well) on each of the study sites. As control, chernozem leached loamy soil (S0) was used, similar to our previous study [7].

Measurements of chemicals concentrations and radionuclides activity were carried out by the Analiz Odpadow Stalych laboratory and Radiometry laboratory of the Central Mining Institute, Katowice.

### **2.2. *Allium*-test**

Equal-sized bulbs were chosen from a population of a commercial variety of the common onion *Allium cepa* L. ( $2n = 16$ ). Thirty bulbs (0.8 - 1.0 cm in diameter) were used for each water sample testing and forty for each sediment sample testing. Developing roots were maintained at  $+4 \pm 2^\circ \text{C}$  in distilled water during 24 hours. After that the bulbs were plunged into the water or sediment samples to be studied. Control samples for water remained in distilled water and water sample WRef (natural control). Water temperature was maintained at  $+22 \pm 2^\circ \text{C}$ . Control samples for sediment were

plunged into chernozem leached loamy soil. Roots of the 1.5 cm length were cut off and fixed in an alcohol/acetic acid mixture (3:1).

To test samples genotoxicity, squashed slides of *Allium cepa* root tips were prepared as described in [8, 9] with aceto-orcein as a dye (saturated solution in 45% HAc). All slides were blindly and randomly coded before cytogenetic analysis. Chromosomal aberrations in ana-telophases (chromatid (single) and chromosome (double) bridges and fragments) were distinguished from mitotic abnormalities (multipolar mitoses, c-mitoses and lagging chromosomes) because of their different origin (chromosomal aberrations sources are affected chromosomes while mitotic abnormalities are due to injured mitotic apparatus, particularly mitotic spindle). Sample cytotoxicity was estimated based on root proliferation that was quantified in parallel for all samples as mitotic index. Genotoxicity was assessed with a frequency of aberrant cells (AC) in root meristem of *Allium cepa*. There were preliminary studies of samples geno- and cytotoxicity to find out if water and/or sediment need a dilution to apply the *Allium*-test successfully, and the main studies.

### 3. Results and discussion

#### 3.1. Chemical elements and radionuclides in water and sediment samples

Data on chemical analysis of water samples show that only reference sample WRef obtained in a non-affected part of the river meets hygienic requirements (Table I). For all impacted water sampling points, there is a significant violation of hygienic standards for composition and properties of water bodies for recreation and domestic purposes. The samples from the underground galleries (W1) and river (W4) show high pollution with heavy metals. Maximum permissible concentrations (MPC) for chemical elements in water bodies assigned for domestic and recreation purposes are not violated in all water samplings only for Al, Cr, Cu, Co, and Zn (except for W2 sample), among 17 pollutants studied (Table I). Concentrations of some chemicals are more than 10 times of the corresponding MPC's. The highest pollution rates take place for Ba (600 - 1900 MPC), Na (150 – 200 MPC), Sr (30 – 40, and Cd (up to 30 MPC). The total content of dissolved solids, and chlorides, in particular, are extremely high; the recommended limits are exceeded 15.6 – 136 times in the total content, and up to 240 times in chlorides content. Waters of high salinity negatively influence flora and fauna species, lead to soil salinity, and other adverse consequences both for ecosystems and agricultural and industrial production. The intervention level for  $^{226}\text{Ra}$  radionuclide is violated in W1, W2, W3 samples collected from the underground galleries, and for  $^{228}\text{Ra}$  in W1, W2, W3, W4. Only water of natural control (WRef) meets requirements of radiation safety for population.

The most polluted samples of sediment (Table II) are collected from the bottom of the Bojszowy settling pond (S2 and S3) where content of Ba, Cu, Mn, and Zn are above the permissible limits. There is an extremely high concentration of Ba in all sediment samples which is from 5 to 50.5 times over the maximum permissible level. Specific activity of radium nuclides in S1 and S4 samples are over the corresponding minimum significant specific activity values, thus, these samples must be considered as solid radioactive wastes [16].

Thus, water and sediment samples tested contain high concentrations of heavy metals and radionuclides that may pose a risk both to human health and to biological components of natural ecosystems.

TABLE I. CHEMICAL ELEMENTS AND RADIONUCLIDES IN WATER SAMPLES

Sample	WG	WC1	WC2	WRef	WB	C
pH	7.25	7.30	7.40	8.20	7.75	6.5–8.5
Dissolved solids, mg/l	136000 <sup>a</sup>	123900 <sup>a</sup>	98850 <sup>a</sup>	236.9	15630 <sup>a</sup>	1000
Chlorides, mg/l	84560 <sup>a</sup>	77290 <sup>a</sup>	57080 <sup>a</sup>	55.7	8807 <sup>a</sup>	300
Sulphates, mg/l	< 10	< 10	2620 <sup>a</sup>	33.1	591 <sup>a</sup>	100
Chemicals, mg/l						
Ca	3607 <sup>a</sup>	6112 <sup>a</sup>	1968 <sup>a</sup>	40.68	380.8 <sup>a</sup>	180
Mg	2965 <sup>a</sup>	3560 <sup>a</sup>	2430 <sup>a</sup>	7.78	351.1 <sup>a</sup>	40
Na	43680 <sup>a</sup>	34940 <sup>a</sup>	30580 <sup>a</sup>	29.66	4805 <sup>a</sup>	120
K	520 <sup>a</sup>	373.4 <sup>a</sup>	508.3 <sup>a</sup>	3.28	80.55 <sup>a</sup>	50
Fe	0.49 <sup>a</sup>	0.58 <sup>a</sup>	0.36 <sup>a</sup>	0.11	0.28 <sup>a</sup>	0.1
Mn	0.02 <sup>a</sup>	0.10 <sup>a</sup>	0.37 <sup>a</sup>	0.01	0.85 <sup>a</sup>	0.01
Ba	440 <sup>a</sup>	1330 <sup>a</sup>	1.1 <sup>a</sup>	0.17	0.2	0.7
Sr	211 <sup>a</sup>	287 <sup>a</sup>	45 <sup>a</sup>	0.14	8.6 <sup>a</sup>	7
Zn	0.73 <sup>a</sup>	1.05 <sup>a</sup>	0.45 <sup>a</sup>	0.022 <sup>a</sup>	0.13 <sup>a</sup>	0.01
Pb	< 0.05	0.12 <sup>a</sup>	< 0.01	< 0.01	< 0.02	0.01
Al	0.2	< 0.2	< 0.2	0.06	< 0.1	0.5
Cr	< 0.02	< 0.02	< 0.01	< 0.01	0.03 <sup>a</sup>	0.001
Cu	< 0.02	< 0.02	< 0.01	0.014 <sup>a</sup>	< 0.01	0.001
Ni	0.025 <sup>a</sup>	0.040 <sup>a</sup>	0.025 <sup>a</sup>	< 0.01	0.021 <sup>a</sup>	0.01
Co	< 0.02	< 0.02	< 0.01	< 0.01	< 0.01	0.01
Cd	< 0.02	0.03 <sup>a</sup>	0.01 <sup>a</sup>	0.0025 <sup>a</sup>	< 0.005	0.0005
Hg	< 0.005	< 0.005	< 0.003	< 0.001	< 0.001	0.0001
Radionuclides, Bq/l						
<sup>226</sup> Ra	95.34 <sup>a</sup>	50.29 <sup>a</sup>	3.42 <sup>a</sup>	0.101	0.366	0.5
<sup>228</sup> Ra	63.84 <sup>a</sup>	18.98 <sup>a</sup>	7.12 <sup>a</sup>	0.04	0.68 <sup>a</sup>	0.2

<sup>a</sup> concentration limit is violated

C - Concentration limits (maximum permissible concentrations for chemical elements in water bodies assigned for domestic and recreation purposes values [10, 11] and intervention levels at radionuclides intake by population with drinking water [12]).

TABLE II. CHEMICAL ELEMENTS AND RADIONUCLIDES IN SEDIMENT SAMPLES

Sample	S1	S2	S3	S4	C
Chemicals, mg/kg					
As	6	5	4	2	10
Ba	3082 <sup>a</sup>	1065 <sup>a</sup>	1092 <sup>a</sup>	10100 <sup>a</sup>	200
Cd	1	1	1	1	2
Co	11	44	28	1	-
Cr	45	59	58	11	100 <sup>b</sup>
Cu	171 <sup>a</sup>	158 <sup>a</sup>	140 <sup>a</sup>	13	132
Hg	<1	<1	<1	<1	2.1
Mn	931	8262 <sup>a</sup>	2351 <sup>a</sup>	167	1500
Mo	2	3	3	1	10
Ni	25	51	36	6	80
Pb	32	67	69	12	130
Zn	184	629 <sup>a</sup>	321 <sup>a</sup>	42	220
Radionuclides, Bq/kg					
<sup>226</sup> Ra, Bq/kg	43007±1196 <sup>a</sup>	3551±129	3741±136	70025±2167 <sup>a</sup>	10 <sup>4</sup>
<sup>228</sup> Ra, Bq/kg	29780±786 <sup>a</sup>	6173±188	5985±219	23011±742 <sup>a</sup>	10 <sup>4</sup>
<sup>224</sup> Ra, Bq/kg	23516±801 <sup>a</sup>	5756±240	6425±270	17568±727 <sup>a</sup>	10 <sup>4</sup>
<sup>40</sup> K, Bq/kg	2192±392	861±179	807±167	1452±453	10 <sup>5</sup>
Dose rate, µSv/h	5.14	1.22	2.24	-	

<sup>a</sup> concentration limit is violated; <sup>b</sup> for Cr<sup>3+</sup>

C - Concentration limits (tentative allowable concentrations in soils with different physical and chemical properties for As, Cd, Cu, Ni, Pb, and Zn [13]; maximum permissible concentrations in soil for other chemicals [14, 15]; minimum significant specific activity values for radionuclides [12]).

### 3.2. Cyto- and genotoxicity of water samples

It was found from the preliminary study on phytotoxicity, 20 times dilution of water samples from the underground galleries (W1, W2, W3) and 3 times dilution for water sampled from the contaminated part of the Gostynka River (W4) are necessary to apply the *Allium*-test. Water sampled in a Rontok settling pond vicinity (WRef, natural control) was suitable for *Allium cepa* germination without dilution.

Mitotic activity in root meristem of *Allium cepa* was slightly inhibited at onion bulbs germinating in the diluted W1-W4 samples (Table III), but there is not found any significant cytotoxic effect ( $p > 5\%$ ). On the contrary, the AC frequency in W1-W3 (underground galleries) significantly exceeds values obtained both for reference sample WRef and distilled water DW (Table III), despite the 20-times dilution applied. In the 3-times diluted W4 sample, cytogenetic damage is higher than in the reference variant. Main contribution to cytogenetic effect is made by chromosome (double) bridges and lagging chromosomes. It is also found that aberration spectrum for W1-W3 samples (underground galleries) distinguishes from that found for W4 (taken from the river), which proves a difference in composition and concentration levels of pollutants in waters originating from different sources. Thus, genotoxic effect of waters sampled in the Upper Silesia post-mining areas is demonstrated with the *Allium*-test.

TABLE III. CYTOTOXICITY AND GENOTOXICITY TESTING OF WATER SAMPLED IN THE POST-MINING AREAS

Sample	Total cells	MI, %	AT	AC, %	Aberrations in types				
					f1+m1	f2	m2	g	3p
W1	1742	30.28 ± 1.82	3455	2.66 ± 0.25 <sup>a, b</sup>	8	5	41 <sup>c</sup>	37 <sup>c</sup>	7
W2	1868	34.42 ± 1.88	3692	2.63 ± 0.30 <sup>a, b</sup>	7	7	40 <sup>c</sup>	39 <sup>c</sup>	18 <sup>c</sup>
W3	1895	31.30 ± 1.70	3636	2.65 ± 0.25 <sup>a, b</sup>	51	3	37 <sup>c</sup>	15	7
W4	1860	31.88 ± 2.26	5666	1.72 ± 0.11 <sup>a</sup>	14	0	32	39 <sup>c</sup>	17 <sup>c</sup>
WRef	1628	36.78 ± 2.73	10210	0.95 ± 0.78	14	8	35	29	7
DW	1731	36.96 ± 2.43	7268	1.39 ± 0.10	14	9	24	30	15

AT – ana-telophases scored; f1, m1 – chromatid (single) fragments and bridges; f2, m2 – chromosome (double) fragments and bridges; g – lagging chromosomes; 3p – multipolar mitoses.

<sup>a</sup> exceeds reference sample (WRef), p<1%; <sup>b</sup> exceeds value for distilled water (DW), p<1%; <sup>c</sup> frequency of this type of aberrations exceeds the value for WRef, p<1%.

### 3.3. Cyto- and genotoxicity of sediment samples

Mitotic activity in root meristem cells of *Allium cepa*, grown on soil sampled from the bank and bottom of the settling ponds (S1-S3) do not differ significantly from each other and from the control (Table IV). Cytogenetic damage to meristem cells of *Allium cepa* grown on S1-S3 samples are significantly higher the control value (Table IV). Sediment sample from the underground gallery (S4) appeared infertile, so it was mixed with more nutrient soil (chernozem leached loamy soil used here as control S0) at a ratio 1:9. After this, the only essential differences between S4 and S0 soils are the presence of radionuclides and high concentration of Ba, which caused both significant inhibition of mitotic activity and increased cytogenetic damage in S4 soil sample (Table IV). In all sediment samples obtained from the technogenically contaminated territory (S1-S4), the frequency of double bridges and lagging chromosomes is increased in comparison to the control. So, the clear genotoxic effect of sediment from the post-mining territory is shown, with important contribution of such severe types of cell damage as chromosome bridges and laggings.

TABLE IV. CYTOTOXICITY AND GENOTOXICITY TESTING OF SEDIMENT SAMPLED IN THE POST-MINING AREAS

Sample	Total cells	MI, %	AT	AC, %	Aberrations in types				
					f1+m1	f2	m2	g	3p
S1	1749	32.47 ± 2.30	4063	2.75 ± 0.25 <sup>a</sup>	6	6	57 <sup>b</sup>	31	12
S2	1809	31.18 ± 2.34	3693	2.29 ± 0.16 <sup>a</sup>	13	2	34 <sup>b</sup>	31	10
S3	1765	34.87 ± 1.31	3860	2.92 ± 0.29 <sup>a</sup>	2	3	57 <sup>b</sup>	42 <sup>b</sup>	12
S4	1615	25.59 ± 1.92 <sup>a</sup>	1744	7.04 ± 0.65 <sup>a</sup>	5	3	56 <sup>b</sup>	68 <sup>b</sup>	11
S0	1810	33.41 ± 1.58	7842	1.27 ± 0.08	16	20	15	26	14

<sup>a</sup> exceeds value for S0, p<1%; <sup>b</sup> frequency of this type of aberrations exceeds the value for S0, p<1%

## 4. Conclusion

The present work and our previous studies [6, 17, 18] show that adequate environment quality assessment cannot rely only on information about pollutants concentrations. Unfortunately, authorities in charge of controlling the levels of industrial load have dealt with limited lists of toxicants. Furthermore, there is a capability for a mutual intensification of the effects of environmental factors that actually occur in situations of low-level exposure, as demonstrated earlier [7, 19]. It is therefore impossible to estimate the biological risk due to the action of a combination of agents based only on



the knowledge of their concentrations in the environment. This conclusion emphasizes the need to update some current principles of ecological standardization, which are still in use nowadays.

Measurement of dose and concentrations of contaminants could provide a detailed description of ecological situation, but only indirectly indicate potential biological consequences. Biological assays, in turn, provide an integrative estimation of toxicity and genotoxicity of environmental pollutants. A combination of these two techniques allows identifying the major sources of risk which require continuous biological monitoring. An adequate assessment of the risk to the environment from contamination needs to be based on the simultaneous use of toxicity and genotoxicity tests. As a genotoxicity test, the *Allium*-based assay of chromosome aberration in anaphase-telophase is for many reasons especially useful for the rapid screening of chemicals involved in environmental hazards. In addition, a good toxicity indicator is given by a mitotic index.

In the present work, a high level of genotoxicity has been observed in all samples tested, but at the same time, only water and artificial mixture of sediments from underground galleries show a high toxicity estimated from the root proliferation. Our results clearly indicate that there is a causal relationship between metal composition and genotoxicity and cytotoxicity of water and sediments samples. Further studies of phenomena on the cellular level, such as effects on cell division, or various chromosome disturbances in addition to breaks are important for better understanding of the action of pollutants on biological systems.

The high sensitivity of the *Allium*-test [5] ensures that contaminants will not be overlooked, which may be of special importance when complex mixtures are to be tested. Therefore, positive results in the *Allium*-test should be considered as a warning and also an indication that the tested compounds may be of risk to human health and our environment. Finally, local biologically relevant contaminations of surface and underground water as well as sediments from the Upper Silesia post-mining areas are displayed by means of the *Allium*-test.

#### ACKNOWLEDGEMENT

This work was supported by Tok-DEV WaterNORM project (contract No. MTKD-CT-2004-003163).

#### REFERENCES

- [1] SERRES, F.J., Utilization of higher plant systems as monitors of environmental mutagens, *Environ. Health Perspect.* **27** (1978) 3.
- [2] RANK, J., NIELSEN, M.H., Genotoxicity of wastewater sludge using the *Allium cepa* anaphase-telophase chromosome aberrations assay, *Mutat. Res.* **418** (1998) 113.
- [3] ANTONSIEWICZ, D., Analysis of the cell cycle in the root meristem of *Allium cepa* under the influence of Ledakrin, *Folia Histochem Cytobiol.* **28** (1990) 79.
- [4] WIERZBICKA, M., The effect of lead on the cell cycle in the root meristem of *Allium cepa* L., *Protoplasma* **207** (1999) 186.
- [5] FISKESJO, G., The *Allium* test as a standard in environmental monitoring, *Hereditas* **102** (1985) 99.
- [6] EVSEEVA, T.I., et al., Genotoxicity and toxicity assay of water sampled from the underground nuclear explosion site in the north of the Perm region (Russia), *J. Environ. Radioact.* **80** (2005) 59.
- [7] GERAS'KIN, S.A., et al., Cytogenetic effects of combined radioactive (<sup>137</sup>Cs) and chemical (Cd, Pb, and 2,4-D herbicide) contamination on spring barley intercalary meristem cells, *Mutat. Res.* **586** (2005) 147.
- [8] GRANT, W.F., Chromosome aberration assays in *Allium*. A report of the US Environmental Protection Agency Gene-Tox program, *Mutat. Res.* **99** (1982) 273.
- [9] FISKESJO, G., The *Allium* test – an alternative in environmental studies: the relative toxicity of metal ions, *Mutat. Res.* **197** (1988) 243.

- [10] GUSEVA, T.V., et al., Hydrochemical Indices of Environmental Conditions. Reference Sources, Socially-ecological union, Moscow (2000).
- [11] MAXIMUM PERMISSIBLE CONCENTRATIONS OF CHEMICAL AGENTS IN DRINKING AND INDUSTRIAL WATER. Hygienic regulations GN 2.1.5.1093-02. Supplement N 3 on GN 2.1.5.689-98, Ministry of Health, Moscow (2002).
- [12] RADIATION SAFETY NORMS: HYGIENIC STANDARDS, Sanitary-epidemiologic normalization, hygienic certification and inspection centre of Russia, Ministry of Health, Moscow (1999).
- [13] TENTATIVE ALLOWABLE CONCENTRATIONS (TAC) OF HEAVY METALS AND ARSENIC IN SOILS WITH DIFFERENT PHYSICAL AND CHEMICAL PROPERTIES. Addendum N 1 to the list of MAC and TAC N 6229-91. Gossanepidnadzor, Russian Federation Ministry of Health, Moscow (1991).
- [14] MAXIMUM PERMISSIBLE CONCENTRATIONS AND TENTATIVE PERMISSIBLE CONCENTRATIONS OF CHEMICAL SUBSTANCES IN SOIL. Hygienic regulations 6229-91. USSR Ministry of Health, Moscow (1991).
- [15] BELYAEV, M.P., Guide on Maximum Permissible Concentrations of Deleterious Substances in Food and the Environment, Gossanepidnadzor, Moscow (1993).
- [16] BASIC SANITARY REQUIREMENTS FOR RADIATION SAFETY. INONIZNG RADIATIN, RADIATION SAFETY. Hygienic regulation 2.6.1.799-99. Russian Federation Ministry of Health, Moscow (2000).
- [17] EVSEEVA, T.I., et al., Genotoxicity and toxicity assay of water sampled from a radium production industry storage cell territory by means of *Allium*-test, J. Environ. Radioact. **68** (2003) 235.
- [18] GERAS'KIN, S.A., et al., Bio-monitoring the genotoxicity of populations of Scots pine in the vicinity of a radioactive waste storage facility, Mutat. Res. **583** (2005) 55.
- [19] EVSEEVA, T.I., et al., Cytogenetic effects of separate and combined action of  $^{232}\text{Th}$  and Cd nitrates on *Allium cepa* root tip cells, Cytology **43** (2001) 803.

# New underground treatment installation for radium removal

S. Chalupnik, M. Wysocka, K. Jarosz

Laboratory of Radiometry, Central Mining Institute  
40-166 Katowice, Pl. Gwarkow 1, Poland  
Email: [s.chalupnik@gig.katowice.pl](mailto:s.chalupnik@gig.katowice.pl)

**Abstract.** For removal of radium from saline waters a method of purification has been developed and implemented in full technical scale in one of Polish coal mines several years ago. The purification station in Piast Colliery was unique, the first underground installation for the removal of radium isotopes from saline waters. Very good results have been achieved - approximately 6 m<sup>3</sup>/min of radium-bearing waters were treated there, more than 100 MBq of <sup>226</sup>Ra and <sup>228</sup>Ra remained underground each day. Purification has been started in 1999, therefore a lot of experiences have been gathered during this period. Since year 2002, a new purification station has been under the construction in another colliery – Ziemowit. The preparation of water galleries, feeding station, pumping station etc. has been finished at the end of 2005. In February 2006, the purification of mine waters was started in this mine, at the level -650 meters. Barium chloride is used as a cleaning agent, and amount of water to be purified is larger as in the Piast mine – reaching 9 m<sup>3</sup>/min., although concentration of radium isotopes is lower. After several months from the start-up of the installation, results of purification are excellent. The removal efficiency is higher than 95%, enabling decrease of radium concentration below 0.5 kBq/m<sup>3</sup>, while before purification the summary concentration of <sup>226</sup>Ra and <sup>228</sup>Ra exceeded 9 kBq/m<sup>3</sup>. Sediments with enhanced radioactivity are settled in the sedimentation galleries, without any contact with the crew or ventilation air. Only an increase of gamma dose rate near the installation is observed due to scaling of radium-barium sulphates in the canal, leading from the installation to the sedimentation galleries. In the paper short description of the installation, results of purification in the start-up period and effects for the environment are presented.

## 1. Introduction

Enhanced concentrations of radium in effluents from coal mines in Upper Silesian Coal Basin (USCB) are leading to the contamination of surface waters. Therefore not only monitoring but control of radium concentrations in these waters is required. In the past enhanced radium activities have been measured in waters, released from eleven coal mines in USCB. Nowadays, due to mitigation measures, applied in some mines, this number is down to five mines. Within 15 years, between 1990 and 2005, the total activity of radium isotopes, released by mining industry to the natural environment is lower of about 70% than previously. Despite that, the total release of radium activity was at the end of 2005 equal 120 MBq/day for <sup>226</sup>Ra and 220 MBq/day in case of <sup>228</sup>Ra. That was one of the reasons, that further measures were required to solve the problem of radioactive pollution entirely.

The more stringent environmental regulations concerning radioactive discharges forced us to investigate the possibility of decontaminating the mine waters. The first task was to design the method for treatment of waters containing radium and barium (called type A waters), which was relatively simple [Lebecka, Lukasik & Chalupnik, 1994]. Such method of radium removal have been implemented in two collieries in early 1990's, and have resulted in a substantial reduction in the amount of radium pumped to the surface – less than 55% of the previous value during period 1990 - 1995 [Michalik et al., 1999].

One of the collieries, releasing radium isotopes into surface settling pond and finally into Vistula River was Ziemowit Mine. In this mine saline brines are very common, and the total inflow into mine galleries exceeds 20 m<sup>3</sup>/min. Radium concentration in these brines is as high as 12 kBq/m<sup>3</sup> for <sup>226</sup>Ra and 20 kBq/m<sup>3</sup> for <sup>228</sup>Ra. Due to the lack of barium in brines (type B waters) from Ziemowit Mine the spontaneous coprecipitation of radium was negligible and only small part of radium remained underground as a result of adsorption on bottom sediments in underground water galleries. Therefore Ziemowit Colliery was the main source of the contamination of small brook, called Potok Golawiecki, a tributary of Vistula River and Vistula itself. Almost 50% of total activity released from all mines in

USCB was dumped into surface waters from Ziemowit. Of about 60 MBq of  $^{226}\text{Ra}$  and 100 MBq of  $^{228}\text{Ra}$  was released daily, despite the fact, that concentrations of radium isotopes in effluents from Ziemowit Mine weren't very high, reaching 1.3 kBq/m<sup>3</sup> in case of  $^{226}\text{Ra}$  and for  $^{228}\text{Ra}$  - 2.5 kBq/m<sup>3</sup>.

The Department of Ecology of the Silesian Province issued in 2001 a decision, obliging the management of the Ziemowit Colliery to undertake all possible efforts to enable mitigation of radium isotopes in effluents from the mine below the level 0.7 kBq/m<sup>3</sup>.

## **2. Construction of the underground purification installation**

Investigations of techniques to purify radium-bearing type B waters were started in Laboratory of Radiometry of the Central Mining Institute in late 1980's. It was connected with the regulations, concerning permissible level of radium isotopes in waste water [The Decree of Polish Atomic Energy Agency, 1989, nowadays not valid since 2002]. Moreover, the long-term release of radium-bearing waters that caused significant local contamination in settling ponds and small rivers, required the assessment of the ecological impact of radioactive pollution. Therefore this aspect of the possibility of radium removal from mine waters was also important. In 1999 an purification station in Piast Colliery started to work at the level -650 meters. This was unique, the first one underground installation for mine water treatment and removal of radium isotopes. Since the end of the year 1999 installation is used in a routine way to purify 6 m<sup>3</sup>/min. i.e. 7 200 m<sup>3</sup>/day of brines with enhanced concentrations of radium isotopes.

The installation in Piast Mine was the first one and became a prototype of the similar installation in Ziemowit Colliery. The construction of the underground purification installation and system has been started in this mine in the year 2003 and finished in 2005. At the beginning of 2006 the implementation of technology has been started and now 9 m<sup>3</sup>/min. i.e. 10 800 m<sup>3</sup>/day of salty waters are treated there.

The purification station is located at the horizon -650 meters below the surface, and the sketch plan of the entire system is shown in Fig.1. Only waters from this level required treatment, as the radium content is correlated with salinity of brines, and salinity increases usually with the depth of the mine.

Brines are pumped through the pipeline (1) to the and outflow from it to the ditch located in the gallery, where the purification installation (2) is located. Two parallel feeders were built for the feeding of barium chloride into water, flowing under feeders (see Fig.2.). That cleaning agent has been chosen, because laboratory tests, done in our laboratory, proved high efficiency of radium removal. Unfortunately, there are some limitations on the use of that chemical. First of all, barium chloride is poisonous and the mining crew had to be trained in relevant safety procedures. Furthermore as well as other organisational and research activities, the background radiation level had to be checked prior to implementing the purification process both in underground galleries and on the surface.

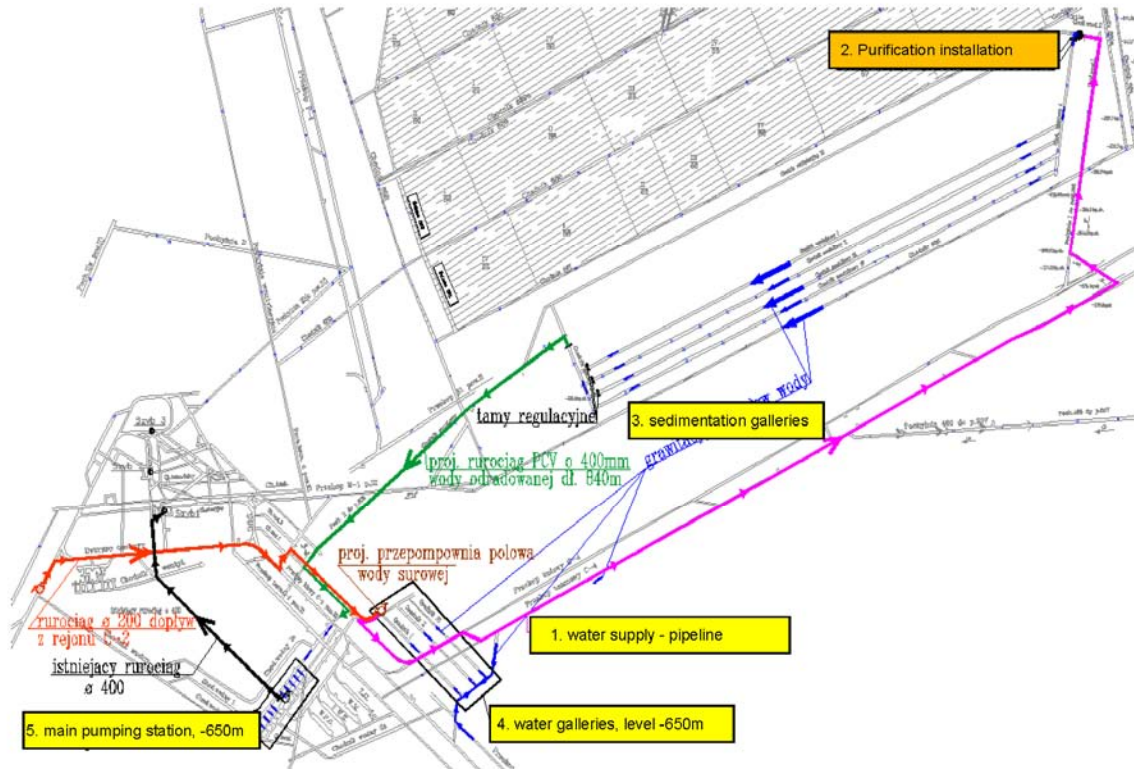

FIG.1. Sketch plan of the water treatment system in Ziemowit Mine



FIG.2. View of the purification station (2) in Ziemowit Colliery – feeders of  $BaCl_2$



Purification of mine waters from radium with application of barium chloride is based on chemical reactions. These reactions are following. Firstly, the barium chloride dissolves in the water.

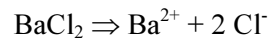

Next step of the reaction is the co-precipitation of radium and barium ions as sulphates (in case of radium reaction is not stoichiometric):



As a result of the latter reaction, small crystals of barium sulphate are formed, but its need a certain time for sedimentation. Therefore waters after treatment are flowing into the closed system of sedimentation galleries (3) with a total volume 65000 m<sup>3</sup>. The retention time of water in the system is of about four days, long enough for the sedimentation not only barium/radium sulphates but mechanical suspension as well. Clean water is flowing to the water galleries (4), from which is finally pumped onto the surface to the settling pond. In the settling pond (see Fig.3.) waters from level -500m (untreated) and from level -650m (after purification) are mixing and finally are released into small brook, Potok Golawiecki. This brook carries all these waters into Vistula River.



*FIG.3. Settling pond with waste brines in the vicinity of Ziemowit Mine*

### 3. Results of purification

The purification of mine waters was started in the Ziemowit Colliery in February 2005. The feed of barium chloride were carried out continuously, at the dose rate of about 50 grams per  $\text{m}^3$ . Since the volume in the settling galleries was assessed as  $65000 \text{ m}^3$  and the daily inflow is approximately  $15000 \text{ m}^3$  we did not expected to record any changes at the outflow until 3-4 days had passed. The radium content in water was monitored at several locations in the system. Water samples were taken from the inflow (before purification), and at the outflow from the system and from waters pumped to the surface. The reservoir at the surface was sampled each day during first several months while waters from Potok Golawiecki were taken every month. Concentrations of radium isotopes in water ( $^{226}\text{Ra}$  and  $^{228}\text{Ra}$ ) were measured by means of liquid scintillation counting, preceded by chemical separation of radium [Chalupnik & Lebecka, 1993].

In Fig.4 preliminary results of purification, achieved during the start up of the new treatment station in Ziemowit Colliery are shown. Curves of  $^{226}\text{Ra}$  and  $^{228}\text{Ra}$  concentrations in the inflowing waters are plotted as well as similar curves for concentrations of radium isotopes in outflow from the system. One important thing must be pointed out – very good results of purification have been achieved quickly, within two weeks. The efficiency of treatment was 95% in average. It means, that the amount of radium isotopes in discharge waters decreased significantly - of about 40 MBq/day in case of  $^{226}\text{Ra}$  and 60 MBq/day for  $^{228}\text{Ra}$ . Total activity of radium isotopes, remaining daily in settling galleries of the system exceeded 100 MBq per day.

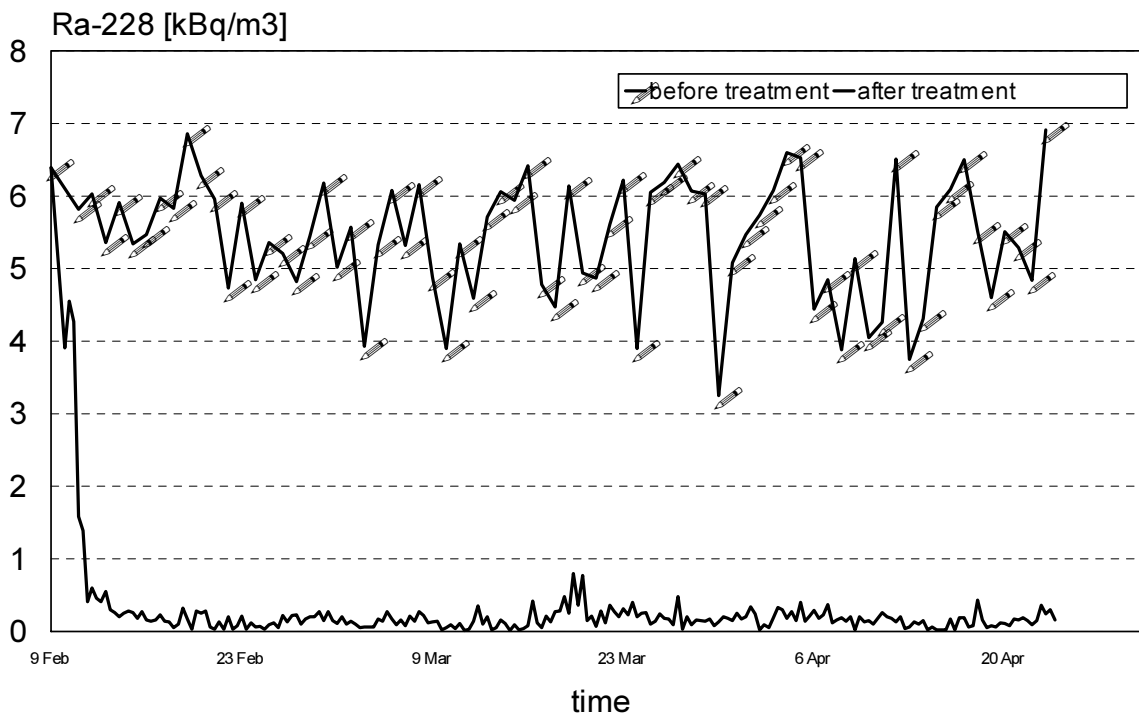

FIG. 4. Preliminary results of water purification in Ziemowit Colliery

Comparison of the effects of purification, achieved in Ziemowit Colliery, with a results from Piast Mine, also for the preliminary period, shows the same pattern of behaviour (see Fig.5.). Very quickly a significant decrease was observed, within several days but later it was sometimes difficult to keep the radium level below target value ( $0.7 \text{ kBq/m}^3$ ). The most important point of the applied technique is a continuous feeding of cleaning agent into the treated water. It depends mostly on the skills and dedication of the crew of the station. Therefore “human factor” is crucial for the successful application of the treatment technology in any mine.

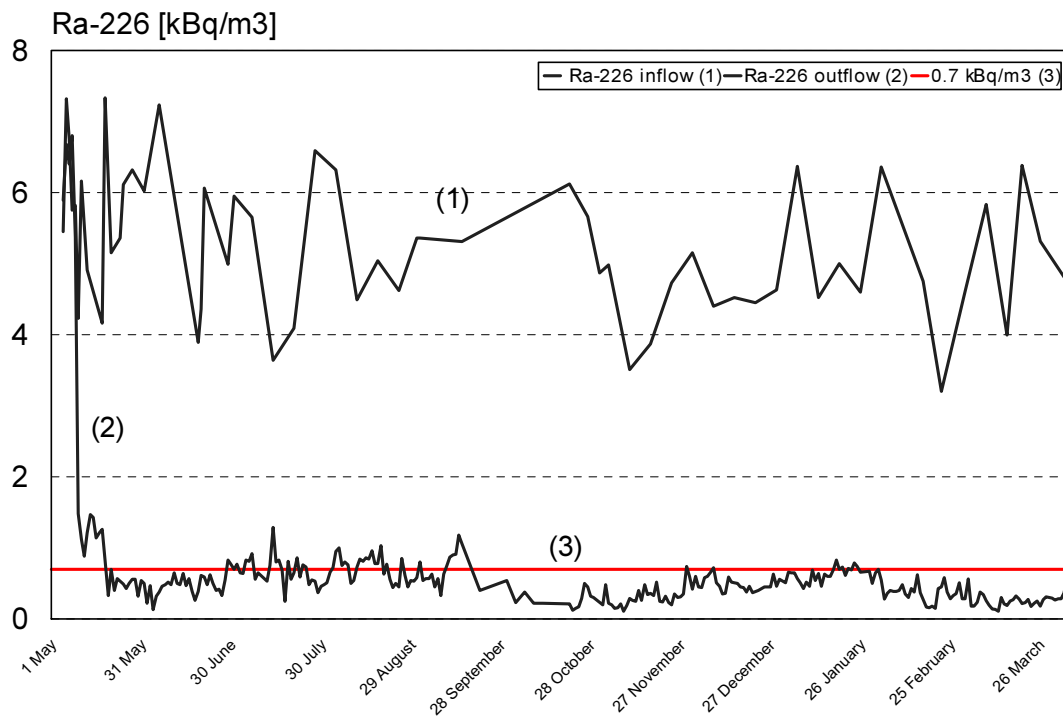

FIG.5. Results of water treatment during the start-up period in Piast Mine

#### 4. Summary

Previous application of the radium removal technology in Piast Colliery enabled treatment of 6 m<sup>3</sup>/min. of saline waters and removal more than 100 MBq of radium from these waters. The purification station in Ziemowit Colliery is second underground installation for the removal of radium isotopes from saline waters in Poland. Its construction was based on the prototype installation in another mine – Piast.

Despite previous experiences the implementation of the method of purification was difficult. In particular the proper work organisation and supervising of the feeding and of the transport of toxic barium chloride in an operating coal mine was very important. On the other hand, observations and experience gathered during the implementation of the method in Piast Colliery was advantageous for the planning and development of similar systems in Ziemowit Colliery.

The ecological effect of the purification is the most important issue. At the outflow from the purification system, at the level -650m the removal efficiency is above 95%. On the surface the efficiency is lower, due to mixing with untreated waters from level -500m, But at the inflow of saline waters into the settling pond, as well as at the outflow from that pond, concentrations of radium isotopes are approximately 80-85% lower than before purification. It corresponds to the decrease of about 40 MBq for <sup>226</sup>Ra and 60 MBq for isotope <sup>228</sup>Ra of daily release from the Ziemowit Mine. It means, that the total amount of radium, discharged into the Potok Golawiecki and Vistula rivers is much lower, by a value 100 MBq/day. This station is still in preliminary period of activity and more detailed reports will be published later.

As a result of water treatment in two underground coal mines, the total activity of radium isotopes, released with waste water into the natural environment, decreased significantly. More than 200 MBq of radium remains in deposits underground, and the contamination of the small tributaries of Vistula and Vistula itself is significantly lower.



## REFERENCES

1. Lebecka J., Lukasiak B., Chalupnik S., 1994 – Purification of Saline Waters from Coal Mines from Radium and Barium – *Proc. of Int. Mine Water Congress*, Quorn Repro Ltd., Loughborough, England.
2. Sałdan M., 1965 - *Biuletyn Instytutu Geologicznego*, Warszawa, Poland, vol. 5, (in Polish).
3. Zarządzenie Prezesa PAA z dnia 19 maja 1989 w sprawie zasad zaliczania odpadów do odpadów promieniotwórczych - Monitor Polski nr 18 poz. 125, Warszawa 1989. Decree, 1989 - Decree of the President of Polish Atomic Energy Agency - A guidelines of classification of radioactive waste materials - Monitor Polski no 18 poz. 125, Warszawa (in Polish)
4. Skubacz K., Lebecka J., Chalupnik S., Wysocka M., 1990, Possible changes in radiation background of the natural environment caused by coal mines activity, *International Symposium on Nuclear Techniques in Exploration and exploitation of Energy and Mineral Resources*, IAEA-SM-308, Vienna.
5. Lebecka J., Chalupnik S., Lukasiak B., Wysocka M., 1993 - Monitoring and Control of Radioactive Contamination of Natural Environment Caused by Mining Activity, Proc. of Int. Conference Ecological Aspects of Underground Mining, Szczyrk, Published by Central Mining Institute, Katowice, Poland.
6. Tomza I., Lebecka J., - Radium-bearing waters in coal mines: occurrence, methods of measurements and radiation hazard - Int. Conf. On Radiation Hazards in Mining, Manuel Gomez ed., Kingsport Press Inc., Kingsport, Tennessee.
7. Lebecka J., et al., 1986 - Influence of Mining Activity on Distribution of Radium in the Natural Environment - *Proc. of 4th Working Meeting Isotopes in Nature*, Leipzig.
8. Lebecka J. et. al., Radioactivity of Mine Waters in Upper Silesian Coal Basin, and its Influence on Natural Environment - *Proc. of Int. Mine Water Congress*, Quorn Repro Ltd., Loughborough, England.
9. Chalupnik S., Wysocka M., Wyniki badań nad oczyszczaniem wód dołowych KWK Czczcott z radu – (Results of purification of radium-bearing waters from Czczcott Colliery), in Polish, Central Mining Institute, Katowice 1996.
10. Urząd Patentowy RP – Patent nr 169869 na :Sposób oczyszczania wód z radu”, dla zespołu pod kierownictwem dr J. Lebeckiej, in Polish – Patent for the metod of radium removal from mine waters.



# Availability of radium isotopes and heavy metals from scales and tailings of Polish hard coal mining

K. Leopold<sup>1\*</sup>, B. Michalik<sup>2\*\*</sup>

<sup>1</sup>University Duisburg-Essen, Geology Dept., Universitaetsstrasse 5, D-45117 Essen, Germany

<sup>2</sup>Central Mining Institute, Plac Gwarków 1, 40-166 Katowice, Poland

**Abstract.** In Poland, saline pit waters resulting from hard coal mining were originally pumped untreated to the surface and discharged into tailing ponds to allow any suspended material to settle. Those waters contained heavy metals and, in some cases naturally occurring radionuclides, mainly <sup>226</sup>Ra and <sup>228</sup>Ra. The radium isotopes were partly deposited as scales inside the discharge tubes or with the tailing pond's sediments. The scales can contain activity concentrations of more than 100 000 Bq/kg of <sup>226</sup>Ra and more than 60 000 Bq/kg of <sup>228</sup>Ra, whilst the tailings have 6000 Bq/kg of <sup>226</sup>Ra and 7200 Bq/kg of <sup>228</sup>Ra. The total volume of such waste material can amount to hundreds of thousands of cubic meters so that they can create a significant risk, especially where pollutants can migrate into the surrounding environment. The availability of the radium isotopes was analysed by applying the standardized 3-step BCR-extraction procedure and measuring the reagents by gamma-spectrometry. Heavy metals were investigated for their water solubility by a leaching test according to a Polish Standard and the extracted solutions were analysed by ICP-AES, thus enabling a rough behaviour comparison between radium and heavy metals. There is different leaching behaviour between the radium isotopes. The tailings being characterized by surface adsorbed radium provide maximal up to 25% all in all of the initial <sup>226</sup>Ra content, <sup>228</sup>Ra is altogether leached up to 15%. The scales comprise stable radiobarite (Ba[Ra]SO<sub>4</sub>) and can be considered as being unable to provide radium isotopes, since no trace of radium dissolution was observed. The leaching behaviour of heavy metals is similar to that of radium. Mn, Ni and Zn are dissolved by water from the tailings; the scales do not provide any.

## 1. Introduction

The Upper Silesian Coal Basin (USCB) is located in the South of Poland, where about 50 underground coal mines are in operation. Due to their activity up to 800 000 m<sup>3</sup>/day of groundwater must be pumped to the surface. These highly mineralised brines often contain elevated levels of radium isotopes and heavy metals as well. Before those saline waters can be discharged into rivers, any suspended load must be removed. For this reason, tailing ponds were built in which the pit water was discharged to allow the suspension to settle on the bottom. In some cases, natural fresh water reservoirs (e.g. fishponds that were very common in the past) have been adapted for this purpose. As a result of the sedimentation process much of the radium isotopes and heavy metals were concentrated in bottom sludge (tailings). Currently, all still-working tailing ponds lie in the areas that belong to particular collieries. Access to these areas is restricted to authorised personnel, hence the potential exposure to external radiation is limited only to staff engaged in well-defined practices and ultimately, controlled in the context of occupational risk monitoring. Serious environmental problems will occur after closing a mine. Such settling ponds, especially those that had been adapted from natural ones, usually were not equipped with any special protective layers, unlike artificial ones, so that the possibility of pollutant migration exists. From the environmental point of view, the migration of pollutants after leaching along with their bioavailability can determine possible detrimental effects. Therefore, in order to make the complex environmental risk assessment, firstly one must investigate the radium's behaviour.

## 2. Sites of investigation

In the USCB, two types of pit waste water can be distinguished based on their radium isotope ratios and ion content [1]. The water of type A contains radium and barium in high concentrations, but no sulphates are present and the activity ratio of <sup>226</sup>Ra:<sup>228</sup>Ra is of about 2:1. In contrast, type B water shows high radium and sulphate contents, but barium is absent and the ratio of <sup>226</sup>Ra:<sup>228</sup>Ra is the opposite of type A: about 1:2. The parameters of "barium" and "sulphate" content are very important

---

\* e-mail: karsten.leopold@uni-due.de

\*\* e-mail: b.michalik@gig.katowice.pl

due to the fact that barium precipitates as barite if sulphate ions are present, e.g. in case of mixing type A waters with other, sulphate containing natural waters. This is significant for the fixing of radium isotopes, because radium can substitute for barium in the crystal lattice. In this case, the mineral is called radiobarite ( $Ba[Ra]SO_4$ ). Therefore, one can expect different behaviour of radium in sediments originated from different types of water. That is why two abandoned surface tailing ponds were chosen for investigations. The main pollutant in each case was different: waste like scales at the bank of Rontok reservoir and sediments at the Bojszowy pond. The former discharge pipe to Rontok reservoir as well as the area in front of it is encrusted by red scale. Two solid samples were taken from these crusts. The second investigated site is now no longer filled with water, so that the suspension sludge resulting from the earlier discharge of pit water is directly accessible. Two solid samples of those tailings were taken at different places within that 16 ha pond. The ambient dose rate was measured 1 meter above the ground level at all sampling sites by CANBERRA InSpector 1000 equipped with IPRON 3 ( $3'' \times 3''$  NaI detector).

### 3. Materials and methods

The availability and chemical bonding of elements in solid materials is commonly investigated by the application of extraction procedures, mostly in sequential steps. In general, sequential extraction procedures were originally developed for the determination of heavy metals. The development of a 5-step procedure was established by [2] and since then, a number of only slightly different procedures have been developed. In order to ensure comparability of results, the Bureau Communautaire de Référence (BCR) of the European Union has proposed a standardized 3-step-method [3]. In relation to radiochemical aspects and especially radium isotopes, there are no dedicated extraction procedures, so that in this study the BCR-procedure was applied for the simultaneous extraction of the most important radium isotopes ( $^{226}Ra$  from uranium series and  $^{228}Ra$ ,  $^{224}Ra$  from thorium series). In order to compare the behaviour of radium and other heavy metals, the routine extraction procedure according to the Polish Standard published in Dz. U. Nr. 120, poz. 1284 (which is very similar to the German DIN 38414-S4), was applied to evaluate the heavy metals' water soluble fractions.

A total of 4 solid samples, 2 sediments and 2 scales, were taken from representative points on both sites. They were homogenized by crushing and sieving for the  $<2$  mm fraction and milling for the  $<0.2$  mm fraction and then dried at  $105^\circ C$  for 24 h. From these 8 samples, 5 g aliquots were taken for the radium investigations. The radium isotopes' initial specific mass activities were measured by a high resolution HPGe gamma-spectrometer with a detection limit of 1 Bq/kg for  $^{226}Ra$ , the given uncertainty quotes to 1-sigma reliability. The radium isotopes were determined by their progenies after equilibrium had been reached by the following gamma energies:  $^{226}Ra$  directly at 186 keV and by  $^{214}Pb$  at 295 keV and 351 keV and  $^{214}Bi$  at 609 keV,  $^{228}Ra$  by  $^{228}Ac$  at 338 keV, 911 keV and  $^{224}Ra$  by  $^{212}Pb$  at 238 keV and  $^{208}Tl$  at 583 keV. The results are given in Bq/kg of dry mass (Table I).

TABLE I. RADIUM ACTIVITY CONCENTRATIONS AND AMBIENT DOSE RATES OF RONTOK- AND BOJSZOWY-SAMPLES

Radionuclide	Rontok 1	Rontok 2	Bojszowy 1	Bojszowy 2
$^{226}Ra$ [Bq/kg]	$40,668 \pm 1,191$	$103,317 \pm 3,173$	$6,438 \pm 312$	$5,343 \pm 208$
$^{228}Ra$ [Bq/kg]	$26,983 \pm 763$	$62,072 \pm 1,803$	$8,507 \pm 385$	$6,370 \pm 224$
$^{224}Ra$ [Bq/kg]	$22,118 \pm 1,074$	$63,981 \pm 3,027$	$9,354 \pm 552$	$6,963 \pm 350$
ambient dose rate [ $\mu Sv/h$ ]	5.14	11.3	1.22	2.24

The sampled wastes were also analyzed for their heavy metal contents by an energy dispersive Roentgen fluorescence spectrometer (XRFS) (Table II).

The samples from both sites are generally characterized by high heavy metal contents, in particular the elements Ba, Co, Zn and Cu are present in high amounts. In case of the Bojszowy samples Mn, Ni, Pb and As are proven in very large concentrations.

TABLE II. HEAVY METAL CONTENT IN RONTOK AND BOJSZOWY SAMPLES  
(Bold italics: exceeding the Polish concentration limit)

parameter	concentration limit* [mg/kg]	Rontok [mg/kg]	Bojszowy 1 [mg/kg]	Bojszowy 2 [mg/kg]
As	5	<b>6</b>	5	4
Ba	200	<b>3082</b>	<b>1065</b>	<b>1092</b>
Cd	1	1	1	1
Co	5	<b>11</b>	<b>44</b>	<b>28</b>
Cr	100	45	59	58
Cu	66	<b>171</b>	<b>158</b>	<b>140</b>
Mn	-	931	8262	2351
Mo	10	2	3	3
Ni	40	25	<b>51</b>	36
Pb	65	32	<b>67</b>	<b>69</b>
Zn	100	<b>184</b>	<b>629</b>	<b>321</b>

\*: According to Polish regulations

### 3.1. Radium

The BCR extraction procedure leads to three chemical fractions: 1. the water soluble and easily exchangeable fraction, 2. the reducible fraction and 3. the oxidizable fraction. As proposed in the official instructions, each sequential reagent should be shaken for 16h, in this study the shaking time was reduced to 7 h due to technical aspects. The shaking was done at 50 rpm and after each step, the suspension was centrifuged for 5 min at 4000 rpm, so the remaining solid material was at the bottom of the cup awaiting the next reagent. The liquids were decanted through a 0.45  $\mu\text{m}$  membrane filter and each reagent volume obtained was exactly determined.

5 g of dried solid material were filled into a centrifugal cup and 3 chemical reagents were added step-by-step. The procedure began for the water soluble and easily exchangeable fraction by adding 0.2 L of acetic acid of 0.11 mol/L and shaking for 7 h. After the removal of the liquid as described above, this was followed by extracting the reducible fraction, which was obtained by using 0.2 L of 0.1 mol/L hydroxylamine chloride adjusted to pH 2 by nitric acid and again shaking for 7 h. The liquid was removed and the oxidizable fraction started with adding 50 ml of 35% hydrogen peroxide twice, each time it was heated to near dryness in roughly 20 min. Then 0.25 L of 1 mol/L ammonium acetate was added, the pH adjusted to 2 by nitric acid, and shaken for 7 h. After this last extraction step the residual was discarded. A scheme of the described procedure is shown in [4].

Before the reagents were measured by gamma-spectrometry, they were solidified to avoid possible particle sedimentation that can influence on measurement efficiency. By doing so, a precipitation of particles on the bottom of the Marinelli beaker and therefore a wrong radionuclide activity concentration determination is avoided. This procedure was done as follows: the extraction liquid's pH was adjusted to 7 by adding NaOH (7 is the pH value that Agar-Agar solidifies), 25 g/L of Agar-Agar was added whilst stirring and then transferred into a Marinelli beaker. That cup was put in boiling water for at least 10 min. This is necessary to destroy the Agar-Agar chains so that no precipitation, either of Agar-Agar or of contained particles, will occur when the cup is allowed to cool. In each Marinelli beaker the liquid level was adjusted for the same height using distilled water, so that the HPGe coaxial detector was surrounded equidistantly at top and sides by the solution. For the calculation of the activity concentration later on the reagents volume was used. To determine the radionuclide concentrations dissolved in each extractant as a proportion of the starting solid material, it is necessary to calculate the volume activity concentration of the extraction liquids as compared to the activity concentration in the dry mass. That is possible because the amount of starting material is weighted carefully before the extraction is undertaken. Therefore, each extraction liquid activity represents a percentage of the starting material's dry mass activity concentration [4].

The measurement of the radium's activity concentration in each extracted liquid was undertaken using the same method as in case of solid samples. Due to the general low radium content in the extraction samples, the measuring time was set to at least 48 h. For measuring such sample sizes of 0.2 L and below, a special calibration was necessary. A water mixture provided by the German Federal Office for Radiation Protection (BfS), which had been used for an intercomparison exercise and therefore very well investigated for its radionuclide content, was used for that purpose. This reference water was also set to a volume of 0.2 L and contains long-lived artificial radionuclides ( $^{54}\text{Mn}$ ,  $^{57}\text{Co}$ ,  $^{60}\text{Co}$ ,  $^{134}\text{Cs}$ ,  $^{137}\text{Cs}$ ,  $^{241}\text{Am}$ ) covering the whole energy range from 59 keV up to 1332 keV. Its preparation was done in the same way as the samples.

### **3.2. Heavy metals**

An extraction procedure according to Polish Standard was applied for determining the water soluble amount of heavy metals by ICP-AES. The extraction procedure demands for 1 L of distilled water to be added to 100 g of dried solid material. This 1:10 solid:liquid mixture was then shaken for 2 h at 15 rpm. After a break of 4 h it was once again shaken for 1 h and then rested for 12 h (overnight). On the next day, the mixture was finally shaken for a further 1 h. So, the shaking procedure was completed within 24 h. The suspension was then centrifuged for 5 min at 4000 rpm and decanted by using a 0.45  $\mu\text{m}$  membrane filter. The extraction liquids were analysed by ICP-AES for Cd, Cr, Cu, Mn, Ni, Pb and Zn. In addition,  $\text{SO}_4^{2-}$  was measured gravimetrically according to the standard ISO 9280,  $\text{Cl}^-$  was determined by titration according to the standard ISO 9297 and  $\text{Na}^+$  by flame photometry according to the standard ISO 9964. The ion and element contents of the extraction liquids are compared with the corresponding permitted concentration limits for waste water in Poland, which is defined as the highest of four classes and published in the Polish regulation Dz.U. 32, poz. 284.

## **4. Results**

### **4.1. Radium**

As expected, there is a wide spread of values for leached radium in the BCR liquids depending on sample site, grain size and chemical reagents used (Table III). Whereas the tailings from Bojszowy pond show varying results within the same extraction fraction and grain size, the Rontok samples are characterized by very homogeneous results, but also very small amounts of leached radium. The Bojszowy sediments show from 1.5 Bq/L up to 7 Bq/L  $^{226}\text{Ra}$  within the 1<sup>st</sup> BCR-fraction suggesting grain size is not of importance;  $^{228}\text{Ra}$  and  $^{224}\text{Ra}$  were not detected. In the 2<sup>nd</sup> BCR-fraction generally higher  $^{226}\text{Ra}$  concentrations can be observed ranging from 9 Bq/L up to 14 Bq/L, whilst in only one fraction (<0.2 mm)  $^{226}\text{Ra}$  is of smaller concentrations of 2 Bq/L. In the 3<sup>rd</sup> BCR-fraction all 3 radium isotopes can be detected and show the highest concentrations leached in this study (up to 12%), the grain sizes <2 mm show higher radium concentrations than the fractions <0.2 mm. For the Rontok samples it must be emphasised that in the 1<sup>st</sup> and 2<sup>nd</sup> BCR-fraction only  $^{226}\text{Ra}$  was to detect with a maximum of 7 Bq/L. In the 3<sup>rd</sup> BCR-fraction radium can be detected frequently, but in very small concentrations and without any obvious connection to grain sizes. For all fractions of both sample sites it is remarkable that  $^{224}\text{Ra}$  was just rarely detectable, which can be explained by its short half-life (3.6 d) so that its concentration is strongly influenced by time when extracted and measured.

TABLE III. EXTRACTED ACTIVITY CONCENTRATIONS OF RADIUM ISOTOPES PER BCR-FRACTION AND LEFT IN RESIDUAL

radionuclide	initial specific activity [Bq/kg]	BCR-Extraction						residual				
		1. BCR		2. BCR		3. BCR		activity concentration [Bq/kg]	concentration [%]			
<b>&lt;2 mm</b>		[Bq/L]	[Bq/kg]	[%]	[Bq/L]	[Bq/kg]	[%]	[Bq/L]	[Bq/kg]	[%]		
Ra-226	6531	1.4 ± 0.8	49 ± 31	0.8	9.3 ± 1.6	324 ± 55	5	9.7 ± 1.6	463 ± 80	7.2	5696	87
Ra-228	8890	< 2.1	< 76	< 0.9	< 4	< 139	< 1.6	8.6 ± 2.2	413 ± 106	4.6	> 8262	> 93
Ra-224	9495	< 1.8	< 66	< 0.7	< 3.3	< 114	< 1.2	17 ± 2.4	807 ± 152	8.5	> 8508	> 90
<b>&lt;0.2 mm</b>												
Ra-226	6345	6.9 ± 0.7	248 ± 25	4	1.9 ± 0.7	71 ± 28	1.1	4.9 ± 0.5	248 ± 24	3.6	5798	91
Ra-228	8124	< 1.8	< 65	< 0.8	2.1 ± 1.2	80 ± 46	1	7 ± 0.7	328 ± 33	4	> 7651	> 94
Ra-224	9213	< 1.5	< 54	< 0.6	< 1.8	< 69	< 0.7	19 ± 1.2	900 ± 60	10	> 8193	> 89
<b>&lt;2 mm</b>												
Ra-226	5067	4.7 ± 0.9	165 ± 35	3.3	12 ± 0.8	426 ± 29	8.5	13 ± 0.6	625 ± 28	12.3	3852	76
Ra-228	6147	< 3.1	< 110	< 1.8	3.8 ± 0.9	137 ± 32	2.2	13 ± 0.7	602 ± 32	10	> 5298	> 86
Ra-224	6813	< 2.7	< 96	< 1.4	< 1.8	< 66	< 1	17 ± 1.2	804 ± 60	12	> 5847	> 86
<b>&lt;0.2 mm</b>												
Ra-226	5618	2.8 ± 0.7	99 ± 25	1.8	14.2 ± 1.7	518 ± 61	9	7.6 ± 1.4	353 ± 65	6.3	4812	84
Ra-228	6593	< 1.7	< 60	< 0.9	< 3.5	< 497	< 2	9.3 ± 2.5	432 ± 116	6.5	> 5976	> 91
Ra-224	7113	< 1.5	< 54	< 0.7	< 3	< 108	< 4.6	< 4.5	< 210	< 3	> 6528	> 92
<b>&lt;2 mm</b>												
Ra-226	40 409	7.4 ± 0.7	270 ± 27	0.7	2.7 ± 1	102 ± 40	0.3	3.2 ± 0.5	150 ± 25	0.4	39 888	98.6
Ra-228	26 322	< 1.9	< 70	< 0.3	< 2.6	< 98	< 0.4	1.5 ± 0.9	70 ± 42	0.3	> 26 085	> 99
Ra-224	21 336	< 1.5	< 54	< 0.3	< 2.1	< 78	< 0.4	1.5 ± 0.9	70 ± 42	0.3	> 21 132	> 99
<b>&lt;0.2 mm</b>												
Ra-226	40 927	5.4 ± 0.7	194 ± 25	0.5	2.3 ± 0.4	87 ± 15	0.2	3.1 ± 0.6	147 ± 29	0.4	40 500	98.9
Ra-228	27 644	< 1.8	< 65	< 0.2	< 1	< 38	< 0.1	1.6 ± 0.8	77 ± 36	0.3	> 27 464	> 99
Ra-224	22 899	< 1.5	< 54	< 0.2	< 0.9	< 33	< 0.1	3 ± 0.9	144 ± 43	0.6	> 22 668	> 99
<b>&lt;2 mm</b>												
Ra-226	101 072	3.3 ± 1.1	124 ± 42	0.1	0.9 ± 0.6	33 ± 22	0.03	1.9 ± 0.5	71 ± 20	0.1	100 844	99.8
Ra-228	64 780	< 3.1	< 117	< 0.2	< 1.6	< 59	< 0.1	2.5 ± 0.6	96 ± 23	0.1	> 64 509	> 99
Ra-224	63 348	< 2.7	< 102	< 0.2	< 1.5	< 54	< 0.1	< 1.5	< 60	< 0.1	> 63 135	> 99
<b>&lt;0.2 mm</b>												
Ra-226	105 562	5.4 ± 1	202 ± 38	0.2	0.8 ± 0.7	30 ± 26	0.03	< 0.5	< 24	< 0.02	> 105 307	99.8
Ra-228	59 364	< 4.7	< 184	< 0.3	0.8 ± 0.8	30 ± 30	0.1	0.6 ± 0.4	28 ± 19	0.05	> 59 121	> 99
Ra-224	64 614	< 2.4	< 90	< 0.1	< 1.2	< 45	< 0.1	< 1	< 47	< 0.2	> 64 338	> 99

## 4.2. Heavy metals

The application of the water leaching test to the tailing samples from the Bojszowy basin leads to a quite high sulphate content (Table IV). The extracted fractions from both samples show levels higher than the Polish concentration limit. Also Mn exceeds the concentration limit in both samples. Cd, Cr, Cu and Pb are not proven to be mobilized. Sodium and chloride ions were dissolved in detectable amounts, in the case of B1 this was higher than the concentration limit. For the Rontok scale, the leaching test leads to the dissolution of less than 30 mg/L of sulphate ions, which corresponds to less than 300 mg/kg solid sample material. Sodium and chloride ions were dissolved partly, heavy metals were not leached.

## 5. Discussion

The leaching test by distilled water applied to the Rontok sample shows some amounts of leached sulphate ( $\text{SO}_4^{2-}$ ), but in general the levels are low (Table IV). There are also very low amounts of leached radium in all 3 BCR-fractions and there is no influence of grain size or chemical condition recognizable (Table III). Both phenomena can be explained by the very stable crystalline structure of barite, so that solutions used are not sufficiently aggressive to disrupt and remove compounds. [5] also observed almost all the radium remained in the residual fraction (a modified extraction procedure according to [6] was applied), if barite is the radium-bearing mineral. Weakly bound salt ions ( $\text{Na}^+$  and  $\text{Cl}^-$ ) are present due to the saline character of the former pit water, but heavy metals were not leached. To prove this, the analysis of chemical compounds of Rontok-sample was carried out by an energy dispersive Roentgen fluorescence spectrometer (XRFS). The results show that the samples really consisted of barium oxide up to more than 57% by weight and of sulphide up to almost 33% by weight. This high barium content comes along with a certain amount of strontium, which can substitute barium due to the very similar chemical properties (both are alkaline earth metals). Beside some silicates, a few alumina-, ferro- and calcitic compounds are present too.

In contrast, the application of the distilled water leaching test to the Bojszowy samples resulted in large amounts of sulphate ions (Table IV). This means that the sulphate is mainly bond to grain surfaces and therefore easily available, which is also in accordance with the pit water's type B classification. The salt content in the Bojszowy samples is quite high and also water soluble, but the leached amounts depend on the sample location within the pond resulting from variations in the salt content. This indication of variation in the tailing composition is also supported by the leached amount of Mn and Zn. The ratio of Mn dissolved by water from the samples B1 and B2 is of 1:14, for Zn of about 1:2. Keeping these results in mind, it is not really surprizing that the amount of leached radium also varies due to chemical conditions and grain size.

Both extraction procedures, the BCR and the Polish one as well, are leading to a water soluble fraction (BCR: 1<sup>st</sup> step). Therefore, a rough comparison of the leached amounts of radium and heavy metals in that fraction is enabled and by viewing both parameters, a good correspondence is shown. The degree of mobilisation for  $^{226}\text{Ra}$  is similar to those of Mn, Ni and Zn, Mn exceeds that range only on one occasion (more than 12% in B2). The stronger reagents used for the 2<sup>nd</sup> and 3<sup>rd</sup> BCR-fraction lead to the highest mobilization rates for radium.

The rare detection of  $^{224}\text{Ra}$  is strongly connected to its short half-life, so it is significantly decayed when the sample was measured and its activity concentration is often below detection limit. But finally, from the radiological point of view and long term perspective the activity concentration will never exceed the activity concentration of  $^{228}\text{Ra}$ . For further investigations, it would be enough to measure only  $^{226}\text{Ra}$  and  $^{228}\text{Ra}$  as the crucial representatives of both natural, uranium and thorium decay series.



TABLE IV. FRACTIONS OF HEAVY METALS AND IONS DISSOLVED BY WATER AND LEFT IN RESIDUAL (Bold italics: exceeding the Polish concentration limit)

element / ion	initial	concentr.	water solubility			concentr.	residual		
	content [mg/kg]	limit* [mg/kg]	[mg/L]	[mg/kg]	[%]	limit* [mg/L]	[mg/kg]	[%]	
<i>Bojszowy 1 [B1]</i>	Cd	1	1	< 0.005	< 0.05	< 5	0.2	> 0.95	> 95
	Cr	59	100	< 0.02	< 0.2	< 0.3	0.5	> 58.8	> 99.7
	Cu	<b>158</b>	66	< 0.02	< 0.2	< 0.1	0.5	> 157.8	> 99.9
	Mn	2351	- / -	<b>8.07</b>	71	3	1	2280	97
	Ni	<b>51</b>	40	0.08	0.7	1.4	0.5	50.3	98.6
	Pb	<b>67</b>	65	< 0.05	< 0.5	< 0.7	0.5	> 66.5	> 99.3
	Zn	<b>629</b>	100	1.08	9.5	1.5	2	619.5	98.5
	SO <sub>4</sub> <sup>2-</sup>			<b>2048</b>	18		500		
	Cl <sup>-</sup>			<b>1654</b>	15		1000		
Na <sup>+</sup>			<b>980</b>	8604		800			
<i>Bojszowy 2 [B2]</i>	Cd	1	1	< 0.005	< 0.05	< 5	0.2	> 0.95	> 95
	Cr	58	100	< 0.02	< 0.2	< 0.3	0.5	> 57.8	> 99.6
	Cu	<b>140</b>	66	< 0.02	< 0.2	< 0.1	0.5	> 139.8	> 99.9
	Mn	8262	- / -	<b>112</b>	1043	12.6	1.0	7219	87.4
	Ni	36	40	0.1	1	2.8	0.5	35	97.2
	Pb	<b>69</b>	65	< 0.05	< 0.5	< 0.7	0.5	> 68.5	> 99.3
	Zn	<b>321</b>	100	<b>2.3</b>	22	6.8	2.0	299	93.2
	SO <sub>4</sub> <sup>2-</sup>			<b>2012</b>	19		500		
	Cl <sup>-</sup>			126	1.2		1000		
Na <sup>+</sup>			116	1.1		800			
<i>Rontok 1 [R1]</i>	Cd	1	1	< 0.005	< 0.05	< 5	0.2	> 0.95	> 95
	Cr	45	100	< 0.02	< 0.2	< 0.4	0.5	> 44.8	> 99.6
	Cu	<b>171</b>	66	< 0.02	< 0.2	< 0.1	0.5	> 170.8	> 99.9
	Mn	931	- / -	< 0.02	< 0.2	< 0.02	1	> 930.8	> 99.98
	Ni	25	40	< 0.05	< 0.5	< 2	0.5	> 24.5	> 98
	Pb	32	65	< 0.05	< 0.5	< 1.6	0.5	> 31.5	> 98.4
	Zn	<b>184</b>	100	< 0.02	< 0.2	< 0.1	2.0	> 183.9	> 99.9
	SO <sub>4</sub> <sup>2-</sup>			27	248		500		
	Cl <sup>-</sup>			18	166		1000		
Na <sup>+</sup>			13	120		800			
<i>Rontok 2 [R2]</i>	Cd			< 0.005	< 0.05		0.2		
	Cr			< 0.02	< 0.2		0.5		
	Cu			< 0.02	< 0.2		0.5		
	Mn			< 0.02	< 0.2		1		
	Ni			< 0.05	< 0.5		0.5		
	Pb			< 0.05	< 0.5		0.5		
	Zn			< 0.02	< 0.2		2.0		
	SO <sub>4</sub> <sup>2-</sup>			29	291		500		
	Cl <sup>-</sup>			48	470		1000		
Na <sup>+</sup>			15	149		800			

\*: According to Polish regulations

## 6. Conclusions

The results clearly show that the availability of radium isotopes in tailings strongly depends on their chemical composition and mineral content. The availability of radium from the scale is significantly less than from sediments. The relatively high moveable proportion of radium in sediments from Bojszowy influences the biota intake and then increases the committed dose. The committed dose, especially in case of alpha-emitters, as radium and its progeny can contribute to the total radiation

hazard far more than only exposure to external gamma radiation. Therefore the Rontok scale, despite of by far the highest content of radium, can be found to be less detrimental than the sediments from Bojszowy with regard to the radiotoxicological aspect.

Investigations of the water soluble fractions showed similar behaviours of radium isotopes and heavy metals. So in this particular case of enhanced natural radioactivity occurrence, the antagonistic or synergistic environmental effects with heavy metals can emerge.

#### ACKNOWLEDGEMENTS

The experimental work was undertaken in the radiometric laboratory of the Polish Central Mining Institute (GIG) located in Katowice. The authors would like to express their gratitude to the staff of the laboratory for their high encouragement. They are also indebted to Dr. Thomas Buenger from BfS, Berlin, for providing the reference water. The investigations presented in this study were carried out in frame of the EU-project "WaterNORM – Project for increasing of research & development potential in the Central Mining Institute", Contract-No. MTKD-CT-2004-003163.

#### REFERENCES

- [1] LEBECKA J., CHALUPNIK S., MICHALIK B., WYSOCKA M., SKUBACZ K., MIELNIKOW A., Radioactivity of mine waters in Upper Silesian coal basin and its influence on natural environment, Proceedings of 5<sup>th</sup> International Mine Water Congress, Nottingham, Published by International Mine Water Association, 1994.
- [2] TESSIER, A., CAMPBELL, P.G.C., BISSON, M.,. Sequential extraction procedure for the speciation of particulate trace metals, *Anal. Chem.* **51** (1979) 844-851.
- [3] URE, A.M., QUEVAUVILLER, PH., MUNTAU, H., GRIEPINK, B., Speciation of heavy metals in soils and sediments – An account of the improvement and harmonization of extraction techniques undertaken under the auspices of the BCR of the Commission of the European Communities, *Int. J. Environ. Anal. Chem.* **51** (1993) 135-151.
- [4] LEOPOLD, K., WIEGAND, J., Chemical types of bonding of natural radionuclides in technologically enhanced naturally occurring radioactive materials (TENORM), these proceedings.
- [5] SCHMIDT, S., WIEGAND, J., Radionuclide contamination of surface waters, sediments and soil caused by coal mining activities in the Ruhr-District (Germany), *Mine Water and the Environment* **22** (2003) 130-140.
- [6] ZEIEN, H., BRUEMMER, G.W., Chemische Extraktionen zur Bestimmung von Schwermetallbindungsformen in Boeden, *Mitt. Dtsch. Bodenkundl. Ges.* **59** (1989) 505-510 (in German).

# Alpha emitting radionuclides in drainage from Quinta do Bispo and Cunha Baixa uranium mines into rivers (Portugal)

**Fernando P. Carvalho, João M. Oliveira, Isabel Faria**

Instituto Tecnológico e Nuclear

Departamento de Protecção Radiológica e Segurança Nuclear,

E.N. 10, 2686-953 Sacavém, Portugal ([carvalho@itn.pt](mailto:carvalho@itn.pt))

**Abstract.** Two large uranium mines, Quinta do Bispo and Cunha Baixa, district of Viseu, North of Portugal, were exploited until recent years. Quinta do Bispo was exploited as an open pit and Cunha Baixa as underground mine and open pit. Sulfuric acid was used for *in situ* leaching in Cunha Baixa mine and for heap leaching of uranium low grade ores at both mines and large amounts of mining and milling residues were accumulated nearby. Extraction of uranium in both mines ceased in the nineties. Pumping and neutralization of acid mine waters was carried out in the following years and effluents from water treatment released into surface water lines. Analysis of radionuclides in the soluble phase and in the suspended matter of water samples from the mines, from the creeks receiving the discharges of mine effluents, from the river collecting these effluents, as well as from wells in this area, show an enhancement of radioactivity levels. Downstream the discharge points of mine effluents into Castelo Stream, the concentrations of uranium isotopes, as well as of other radionuclides such as  $^{226}\text{Ra}$ ,  $^{230}\text{Th}$ ,  $^{210}\text{Pb}$  and  $^{210}\text{Po}$  in river water were up to 10 times the concentrations measured upstream. However, radionuclide concentrations in river water and in suspended matter decreased rapidly to near background values in a distance of about 7 kilometers from the discharge points. Enhancement of radioactivity in underground waters was detected also and radionuclide concentrations were positively correlated with a decrease in water pH and with an increase of sulfate ion concentration, pointing out to the Cunha Baixa mine as the source of groundwater contamination. The potential impact from the use these waters on soil radioactivity and radionuclide transfer to man through consumption of vegetables and cattle grazing is discussed.

Key words: uranium, uranium mines, natural radioactivity, enhanced radioactivity levels.

## 1. Introduction

Exploitation of radioactive ores in Portugal lasted from 1908 to 2001, and took place mainly in the centre-north of the country. Mines at Quinta do Bispo and Cunha Baixa, near the city of Viseu, were amongst the largest ones (Figure 1). The richest ores from Quinta do Bispo and Cunha Baixa were extracted and sent to the Urgeiriça facilities for uranium extraction by dynamic leaching with sulfuric acid.

The mine of Cunha Baixa was exploited from 1967 to 1991, in the beginning by underground works and in more recent years as an open pit. Sulfuric acid was used for *in situ* leaching of uranium in underground works as well as in heap leaching of low grade ores at the surface. Since cessation of mining, the acid water has been pumped out through the main shaft of the mine for neutralization with hydroxide. A total of about 0.5 Mtons of ore were extracted from this mine and resulting tailing materials and sludge from acid water treatment were dumped nearby. <sup>[1]</sup>

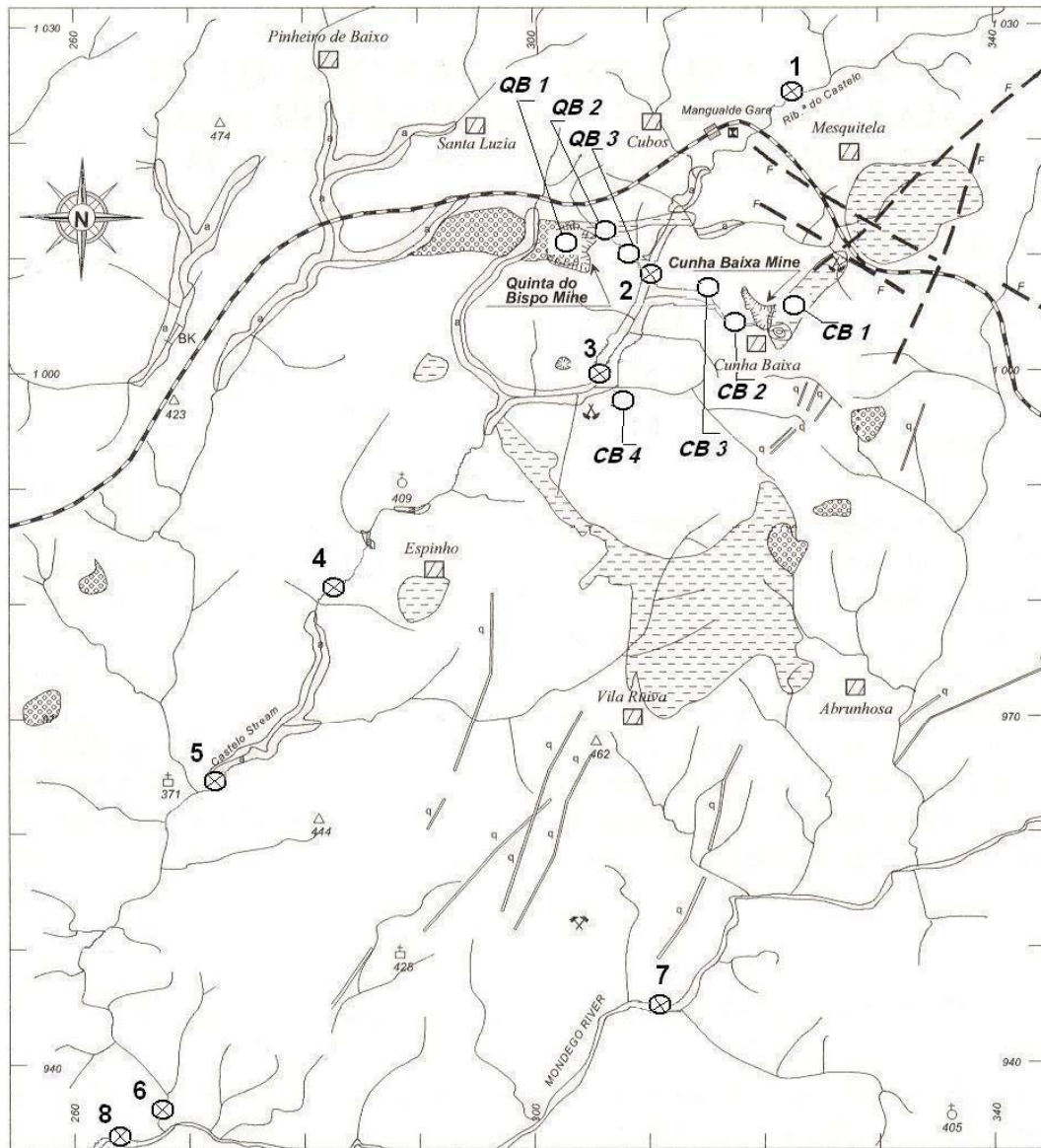

**LEGEND**

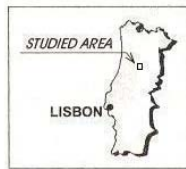

- |  |                                   |  |  |
|--|-----------------------------------|--|--|
|  | Mine open pit                     |  | Recent alluvium                                      |
|  | Quarry                            |  | Arcosic and clay deposits                            |
|  | Public dismissal                  |  | Metasedimentary; migmatites                          |
|  | Railway                           |  | Granitoids (essentially monzonitic with some facies) |
|  | Small area studied in more detail |  | Quartz vein  |
|  |                                   |  | Geological fault (observed and/or inferred)          |

Figure 1. Map of the area investigated. Sampling stations are indicated with circles. Circles with cross indicate sampling stations in the Castelo Stream and Mondego River.

The mine of Quinta do Bispo is located near 2 km West of Cunha Baixa, and it was exploited as an open pit exclusively. Low grade ores were extracted by the heap leaching method near the mine, and the acid waste waters were discharged into the open pit. About 1.6 Mtons of waste materials including low grade ores, sterile gravel and milling tailings are disposed on surface. Neutralization of acid waters from the open pit has been performed and treated water discharged into surface water lines.<sup>[2]</sup>

Water lines receiving waste waters both from Cunha Baixa and Quinta do Bispo mines drain into the Castelo Stream, a tributary of Mondego River the largest river in this region. The environmental impact of these uranium exploitations was recognized and both sites were recently included in the list of old mining areas to be environmentally rehabilitated.<sup>[2]</sup>

This report gives an account of the current levels of environmental radioactive contamination dispersed from these mines into the receiving water bodies.

## 2. Materials and Methods

Water samples were collected (in May 2002) from uranium mines, creeks, rivers and wells, directly into polyethylene drums and filtered on site. Filtration was performed using membrane acetate filters with 0.45  $\mu\text{m}$  pore size and 142 mm in diameter. Filtered water was acidified with  $\text{HNO}_3$  to pH below 2, and filters with suspended matter were stored for later analysis in the laboratory. Water and suspended matter samples were analyzed by radiochemical methods and alpha spectrometry as described elsewhere.<sup>[3] [4]</sup> In brief, known amounts of isotopic tracers ( $^{232}\text{U}$ ,  $^{229}\text{Th}$ ,  $^{209}\text{Po}$ ,  $^{224}\text{Ra}$ , and stable  $\text{Pb}^{2+}$ ) were added to the samples in the beginning of the chemical processing. Radionuclides were precipitated in the case of water samples and the re dissolved precipitate passed through ion exchange columns in order to separate and purify the radioelements to quantify. Samples of suspended matter were spiked with the isotopic tracers and completely dissolved with acids before chemical extraction of radioelements by ion exchange column chromatography. Solutions of purified radioelements were then transferred to electroplating cells and radionuclides plated onto stainless steel or silver discs. Radionuclides were measured with silicon surface low background detectors. These methods have been thoroughly tested and accuracy and precision tested in intercomparison exercises. Physical chemical parameters of water were measured *in situ* with a portable multiparameter probe. Dissolved ions were determined by ion chromatography.

## 3. Results and discussion

Radionuclide concentrations in mine waters and in selected examples of surface and well waters are shown in Table 1. In the water from the open pit of Quinta do Bispo mine, pH=2.67,  $^{238}\text{U}$  was 92 000  $\text{mBqL}^{-1}$ , and  $^{226}\text{Ra}$  was 1100  $\text{mBq L}^{-1}$ . In the water from Cunha Baixa underground mine, pH=3.48, where water has been continuously extracted for acid neutralization during several years,  $^{238}\text{U}$  was 2200 and  $^{226}\text{Ra}$  was 84  $\text{mBq L}^{-1}$ , much above naturally occurring concentrations in surface waters.<sup>[3]</sup>

In Quinta do Bispo mine, after acid neutralization with hydroxide and decantation of the precipitate in ponds, radionuclide concentrations in discharges into the water line (QB2, QB3) were much reduced in comparison with untreated water. For example the concentrations of dissolved  $^{238}\text{U}$  and dissolved  $^{226}\text{Ra}$  are reduced by a factor of 46 and 12, respectively. However, despite this treatment, the water in the receiving water line was still acid and contained elevated concentrations of radionuclides (Table 1).

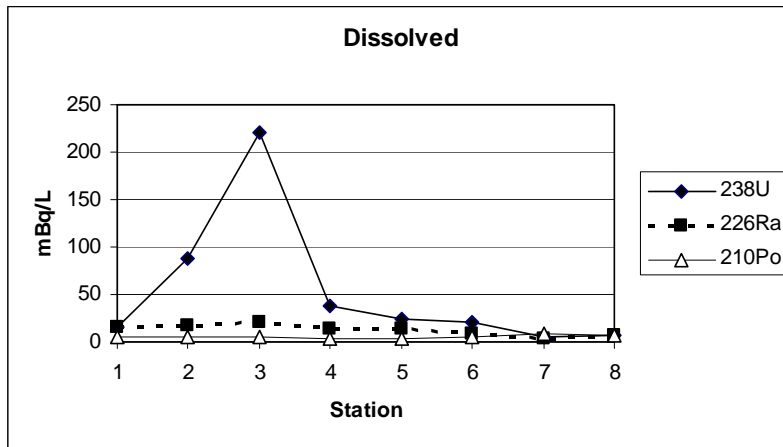

Figure 2. Radionuclide concentrations in the dissolved phase of water of Castelo stream and Mondego River.

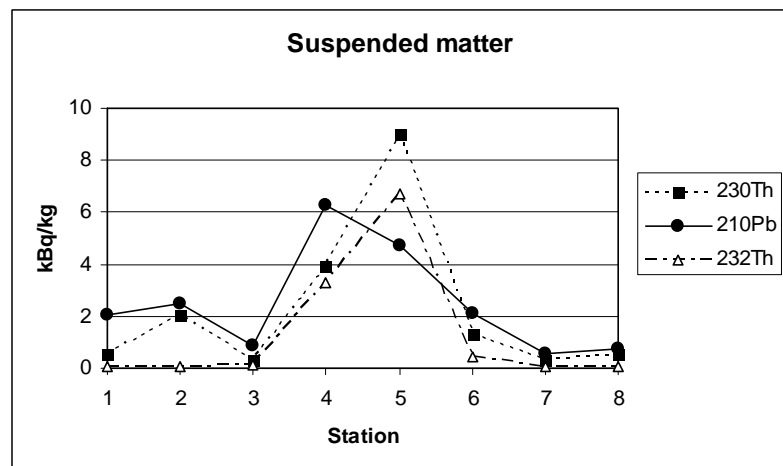
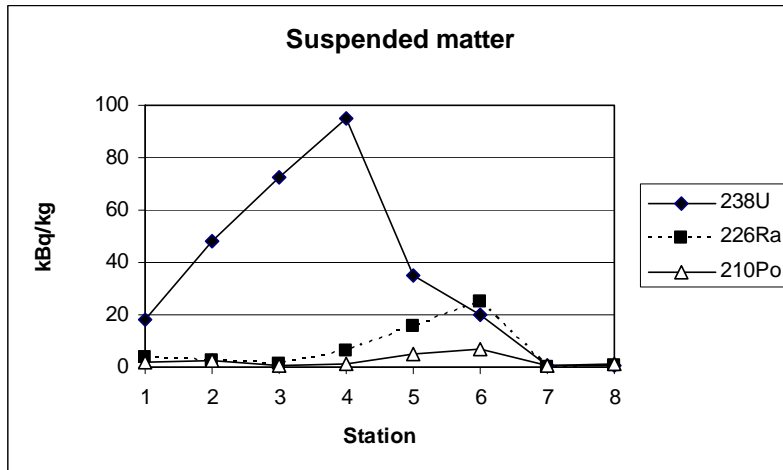

Figure 3. Radionuclide concentrations in the particulate phase of the water of Castelo stream and Mondego River.

In Cunha Baixa, acid water pumped out from the underground mine (CB1) was treated also with hydroxide, decanted in a pond, and the supernatant discharged into a water line flowing to the Castelo Stream. However, especially during summer, this water infiltrates the soil rapidly and largely seeps into the alluvium soil by the Castelo stream.

Concentration of radionuclides dissolved in the water of Castelo Stream increase with the discharge of waste waters originated in both mines (Figure 2). For example, dissolved  $^{238}\text{U}$  increased from the naturally-occurring concentration of  $15.6 \text{ mBq L}^{-1}$  at station 1 to  $220 \text{ mBq L}^{-1}$  at the station 3, after receiving drainage from Quinta do Bispo and Cunha Baixa. From this station downstream, dissolved uranium concentrations decreased regularly and the enhancement of  $^{238}\text{U}$  concentration between station 7 and station 8 in the river Mondego, was from 5 to  $7 \text{ mBq L}^{-1}$  only. It should be noticed that the increase of dissolved uranium in stream water was not accompanied with large increases of  $^{226}\text{Ra}$  and  $^{210}\text{Po}$  concentrations in the dissolved phase (Figure 2).

Concentration of radionuclides in the particulate matter carried by the Castelo stream, displayed also a strong increase for particulate uranium after the discharges from the two mines. Uranium concentrations in this stream were enhanced by a factor of about 4 in the solid phase and of about 14 in the soluble phase. Concentrations of  $^{226}\text{Ra}$  and  $^{210}\text{Po}$  in the suspended matter were also enhanced along the Castelo Stream (Figure 3). The same trend was observed also for  $^{230}\text{Th}$ ,  $^{210}\text{Pb}$  and  $^{232}\text{Th}$  radioisotopes that usually are more associated with the solid phase.<sup>[5]</sup> Nevertheless, a significant reduction in concentrations both in dissolved as well as in particulate phases was observed during the 7 km of the Castelo Stream from mine discharges to the junction with Mondego River. This reduction occurs by action of pH and chemical composition of water and sediments that precipitate, sorbs, and dilute radionuclides released into the stream.

It was observed earlier that concentrations in suspended matter of the rivers of this region are positively correlated with radionuclide concentrations in fine grain fraction of bottom sediments.<sup>[5]</sup> Therefore, based on these observations, we may infer that the riverbed sediments of Castelo Stream have enhanced radionuclide concentrations also due to the cumulative discharges of waste water from uranium mines.

The distribution of uranium series radionuclides along the surface water lines, and especially along the Castelo Stream is in agreement with the results of geochemical studies performed in the same area focusing stable metals associated to the radioactive ore.<sup>[6][7]</sup>

Water from shallow wells located between the Cunha Baixa mine and the Castelo Stream (CB2, CB3, CB4), tapping the subsurface aquifer at about 5 meters depth, frequently displayed low pH (between 4 and 5.5) and high sulfate content (usually ranging from 400 to  $1500 \text{ mg L}^{-1}$ ). These waters were analyzed for uranium series radionuclides and major ions. A significant negative correlation ( $r^2 = 0.74$ ,  $p < 0.01$ ) was found between sulfate ion and pH in mine waters and well waters (not shown). Concentrations of dissolved uranium series radionuclides decreased with increased pH values, i.e., radionuclide concentrations were higher in waters with higher sulfate ion concentrations (Figure 4). Incidentally, this result suggests the use of a simple method, based on the measurement of acidity or dissolved sulfate with a portable probe, to monitor the spread of radioactive contamination in ground waters of this area.

Low pH and high radioactivity in well waters, sometimes even higher than in the effluents discharged into the water line, indicate that use of sulfuric acid in the underground mine of Cunha Baixa originated acid waters that did circulate in the fractured rock and infiltrated ground waters. The circulation of groundwater from Cunha Baixa mine reaches the low lands on the east bank of

Table 1. Radionuclide concentrations in the dissolved phase and suspended matter of water from the mines of Quinta do Bispo (QB) and Cunha Baixa (CB), irrigation wells, Castelo Stream and Mondego River. Water pH, sulfate ion concentration ( $\text{mg L}^{-1}$ ) and load of suspended matter ( $\text{mg L}^{-1}$ ) are also shown.

	$^{238}\text{U}$	$^{235}\text{U}$	$^{234}\text{U}$	$^{230}\text{Th}$	$^{226}\text{Ra}$	$^{210}\text{Pb}$	$^{210}\text{Po}$	$^{232}\text{Th}$	pH	$\text{SO}_4^{\text{F}}$
<b>Dissolved (<math>\text{mBq L}^{-1} \pm 1\sigma</math>)</b>										
QB1-open pit	(92.0±4.2)E3	(4.2±0.6)E3	(73.5±3.5)E3	-	(1.1±0.1)E3	(1.2±0.1)E3	87 ± 4	-	2.67	3645
QB2-water line	(2.2±0.1)E3	110 ± 6	(1.1±0.1)E3	-	92 ± 5	89.2 ± 5.2	40 ± 3	-	3.81	2495
QB3-water line	679 ± 31	33 ± 2	605±28	-	46 ± 3	11.0 ± 1.2	36 ± 3	-	4.15	2370
CB1-mine water	(2.2±0.2)E3	106±11	(1.9±0.2)E3	-	84 ± 5	130 ± 6	247± 13	-	3.48	1380
CB2-well	256 ± 11	10.8 ± 0.7	243±11	-	45 ± 8	27 ± 1	21 ± 1	-	5.18	16.0
CB3-well	75 ± 3	3.7 ± 0.3	75 ± 3	-	47 ± 4	32 ± 2	32 ± 1	-	5.26	12.1
CB4-well	415 ± 18	17.7 ± 0.9	392±17	-	61 ± 7	92 ± 7	89±3	-	4.65	461
Castelo Stream1	15.6 ± 0.4	0.65 ± 0.04	15.6 ± 0.4	-	16 ± 3	-	4.6 ± 0.2	-	5.98	9.1
Castelo Stream3	220 ± 10	9.7 ± 0.6	211± 9	-	20 ± 2	-	4.5 ± 0.2	-	6.06	599
Castelo stream6	20 ± 1.0	0.96 ± 0.13	21 ± 1.0	-	8.7 ± 1.6	3.0 ± 0.2	5.7 ± 0.2	-	7.87	72
Mondego Riv 7	5.1 ± 0.2	0.23 ± 0.03	5.4 ± 0.2	1.3 ± 0.2	3.2 ± 0.2	-	8.5 ± 0.4	0.18 ± 0.07	6.61	-
Mondego Riv 8	7.2 ± 0.2	0.32 ± 0.03	7.7 ± 0.2	1.8 ± 0.2	6.1 ± 0.4	-	7.6 ± 0.3	0.27 ± 0.06	6.50	-
<b>Suspended matter (<math>\text{kBq kg}^{-1} \pm 1\sigma</math>)</b>										
QB1-open pit	5.4 ± 0.2	0.22 ± 0.02	5.6 ± 0.2	31 ± 2	12.4 ± 1.2	36 ± 1	35 ± 2	0.047±0.007	11.5	
QB2-water line	0.42 ± 0.02	0.014±0.004	0.41±0.02	6.7 ± 0.4	1.6 ± 0.4	0.94 ± 0.05	0.93 ± 0.04	0.011±0.002	90.9	
QB3-water line	0.75 ± 0.03	0.043±0.006	0.69±0.03	4.4 ± 0.3	4.0 ± 0.7	1.18 ± 0.05	0.96 ± 0.04	0.005±0.002	57.6	
CB1-mine water	2.2 ± 0.1	0.16 ± 0.03	2.5 ± 0.2	2.9 ± 0.2	4.6 ± 0.2	17.8 ± 0.7	36 ± 2	0.12 ± 0.02	6.0	
CB2-well	3.4 ± 0.1	0.17 ± 0.02	3.3 ± 0.1	0.11 ± 0.01	0.68 ± 0.06	5.9 ± 0.2	3.4 ± 0.1	0.025±0.004	6.3	
CB3-well	3.2 ± 0.1	0.15 ± 0.02	3.2 ± 0.1	0.34 ± 0.03	2.0 ± 0.4	26 ± 1	11.2 ± 0.4	0.031±0.07	2.5	
CB4-well	23.3 ± 0.7	1.02 ± 0.08	21.7 ± 0.6	2.9 ± 0.2	6.9 ± 0.7	13.4 ± 0.7	15.7 ± 0.7	0.16 ± 0.02	0.7	
Castelo Stream1	18.3 ± 0.7	0.86 ± 0.06	17.8 ± 0.7	0.53 ± 0.03	4.0 ± 0.1	2.02 ± 0.08	1.67 ± 0.09	0.064±0.007	2.5	
Castelo Stream3	72.2 ± 2.6	2.9 ± 0.1	68.5 ± 2.4	0.31 ± 0.02	1.5 ± 0.1	0.84 ± 0.03	0.73 ± 0.03	0.126 ± 0.09	11.3	
Castelo Stream6	19.7 ± 0.9	0.9 ± 0.1	19.7 ± 0.9	1.3 ± 0.1	25.3 ± 2.9	-	6.6 ± 0.3	0.41±0.06	0.6	
Mondego Riv 7	0.43 ± 0.01	0.019 ± 0.002	0.42 ± 0.01	0.34 ± 0.01	0.30 ± 0.02	-	0.67 ± 0.02	0.060±.004	14.6	
Mondego Riv 8	0.73 ± 0.02	0.035 ± 0.003	0.79 ± 0.02	0.54 ± 0.02	0.47 ± 0.02	-	1.01 ± 0.03	0.090±.005	10.0	



Castelo Stream and seems to enhance radionuclide concentrations in most of the wells in the area (Table 1).

Previous work carried out in this area had found high  $^{226}\text{Ra}$  concentrations also in water from wells. These high concentrations were considered as originating in  $^{226}\text{Ra}$  in releases of waste waters, due to partial removal only of radium from the acid mine water by the waste water treatment plant, as well as in leaching of radium from the tailing piles disposed near the mine.<sup>[7]</sup> Geochemical investigations in the area had found enhanced concentrations of uranium and  $^{226}\text{Ra}$  in soils and stream sediments due to the dispersal of radionuclides from waste waters originated in both mines.<sup>[2]</sup> Furthermore, a preliminary assessment of the chemical impact resulting from the operation of Cunha Baixa mine concluded that drainage affects surface and groundwater quality in a range of about 1.5 km downward from the mining site. Main contaminants found were sulfate, Al, Mn and U.<sup>[6]</sup>

Irrigation with these waters was considered likely to increase concentrations of stable metals and radionuclides in soils and, thus, to expose consumers to an intake of metals and radioactivity higher than elsewhere in the region.<sup>[6]</sup> Further work should elucidate the transfer of radionuclides to plants grown in this area.

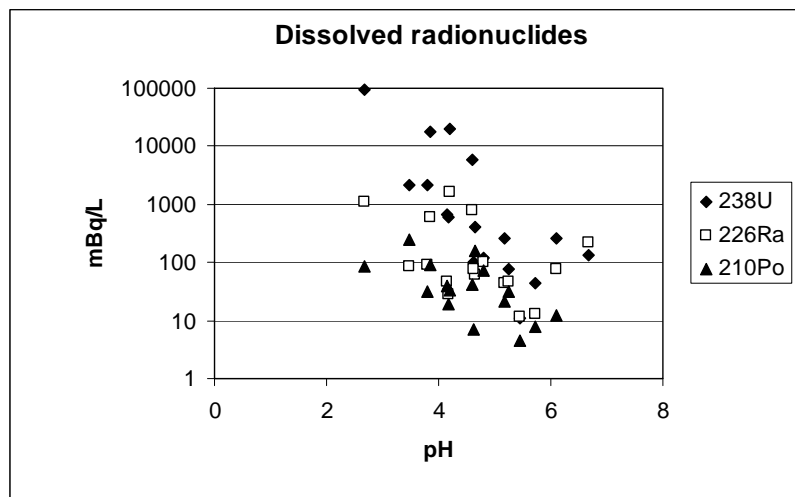

Figure 4. Concentration of dissolved radionuclides in water from wells and uranium mines as a function of water pH.

#### 4. Conclusions

Concentrations of uranium series radionuclides in acid waters from the Cunha Baixa mine and from the open pit of Quinta do Bispo, were very high. The treatment of these acid waters with hydroxide, followed by decantation of precipitate in ponds, removed a large fraction of radioactivity. Notwithstanding, concentrations of radionuclides in water and suspended matter of the Castelo Stream receiving treated effluents still showed enhanced radioactivity values. Nevertheless, enhanced radionuclide concentrations did not spread far from the mine sources and, in the Mondego River, concentrations were already near background values.

Surface waters are not the only water body receiving acid mine waters and treated mine effluents. In the agriculture area of Cunha Baixa, irrigation wells show a trend in sulfate ion concentration and pH values that point out to Cunha Baixa mine water as the source of ground water contamination. The analyses of radionuclides in well waters confirm high radionuclide

concentrations associated to the high sulfate and low pH values, and thus confirm contamination of the aquifer with acid mine water.

Irrigation of horticulture plots with water from these wells is likely to gradually increase radioactivity in the top layer of soil and to get concentrated in vegetables and grains. These radionuclides may then be transferred by food chain to cattle and to man. The radiological risk of this potential contamination pathway to man should be assessed in future work.

Acknowledgements- Are due to the International Atomic Energy Agency by the support provided through Technical Cooperation Project POR/4/015.

## References

- [1] J.M. NERO, J.M. DIAS, A.J. TORRINHA, L.J. NEVES, J.A. TORRINHA (2005). Environmental evaluation and remediation methodologies of abandoned radioactive mines in Portugal. In: *Proceed. of an International Workshop on Environmental Contamination from Uranium Production Facilities and Remediation Measures*, held in Lisbon 11-13 Feb 2004, pp.145-158. International Atomic Energy Agency, Vienna.
- [2] J.M.SANTOS OLIVEIRA, M.J.CANTO, M.Y. PEDROSA, P. AVILA, M.R. MACHADO LEITE (2005). Geochemical evaluation for the site characterization of the Cunha Baixa Uranium mine in Central Portugal. In: *Proceed. of an International Workshop on Environmental Contamination from Uranium Production Facilities and Remediation Measures*, held in Lisbon 11-13 Feb 2004, pp.233-243. International Atomic Energy Agency, Vienna.
- [3] F.P. CARVALHO, J.M. OLIVEIRA, A. LIBÂNIO, I. LOPES, G. FERRADOR, M.J. MADRUGA (2005). Radioactivity in Public Water Supplies in the Uranium Mining Regions in Portugal. In: *Proceed. of an International Workshop on Environmental Contamination from Uranium Production Facilities and Remediation Measures*, held in Lisbon 11-13 Feb 2004, pp.41-51. International Atomic Energy Agency, Vienna.
- [4] J.M OLIVEIRA, F.P. CARVALHO (2006). A Sequential Extraction Procedure for Determination of Uranium, Thorium, Radium, Lead and Polonium Radionuclides by Alpha Spectrometry in Environmental Samples. (Proceedings of the 15<sup>th</sup> Radiochemical Conference). *Czechoslovak Journal of Physics* 56 (Suppl. D): 545-555.
- [5] F.P. CARVALHO, J.M. OLIVEIRA, M.J. MADRUGA, I.LOPES, A.LIBANIO, L. MACHADO (2006). Contamination of hydrographical basins in uranium mining areas of Portugal. In: *Uranium in the Environment: Mining Impacts and Consequences*. B.J. Merkel and A. Hasche-Berger Editors, pp 691-702. Springer-Verlag Berlin Heidelberg Publ.
- [6] M.O. NEVES, M.J. MATIAS, M.M. ABREU, M. C.F. MAGALHÃES, M.J. BASTO (2005). Abandoned mine site characterization for remediation: the case of the Cunha Baixa uranium mine (Viseu, Portugal). In: *Proceed. of an International Workshop on Environmental Contamination from Uranium Production Facilities and Remediation Measures*, held in Lisbon 11-13 Feb 2004, pp.159-169. International Atomic Energy Agency, Vienna.
- [7] A.J.S.C. PEREIRA, L.J. PEREIRA, P. F. NEVES, J. M. M.DIAS, S.V. T. BARBOSA (2005). Environmental hazards at the former uranium mines Urgeiriça, Cunha Baixa, and Quinta do Bispo. In: *Proceed. of an International Workshop on Environmental Contamination from Uranium Production Facilities and Remediation Measures*, held in Lisbon 11-13 Feb 2004, pp.181-191. International Atomic Energy Agency, Vienna.

# Estimates of occupational exposure to TENORM in a phosphoric acid production plant in Iran

N. Fathabadi, M.V. Farahani, M. Moradi, B. Haddadi

Environmental Monitoring Section, National Radiation Protection Department  
Iranian Nuclear Regulatory Authority, Atomic Energy Organization of Iran (AEOI), Tehran, Iran

**Abstract.** Phosphate rock is used world-wide for manufacturing phosphoric acid and several chemical fertilizers. It is known that the phosphate rock contains various concentrations of uranium, thorium, radium and their daughters. Subject of this study is evaluation of the radiation exposure to workers in the phosphoric acid production plant due to technologically enhanced naturally occurring radioactive materials (TENORM) that can result from the presence of NORM in phosphate ores used in the manufacturing of phosphoric acid. Radiation exposure due to direct gamma radiation, dust inhalation and radon gas has been investigated and external and internal doses of exposed workers have been calculated. Natural radioactivity due to  $^{40}\text{K}$ ,  $^{226}\text{Ra}$  and  $^{232}\text{Th}$  had been measured in phosphate rock, phosphogypsum, chemical fertilizers and other samples by gamma spectrometry system with a high-purity germanium (HPGe). The average concentrations of  $^{226}\text{Ra}$ ,  $^{40}\text{K}$  observed in the phosphate rock are  $>760$  and  $>80$ , respectively. External dose due to gamma radiation had a mean value of approximately  $0.675 \text{ mSv y}^{-1}$ . Dust sampling revealed greatest values in the storage. The annual average effective dose from inhalation of long lived airborne was  $0.141 \text{ mSv}$ . Radon gas concentrations in the processing plant and storage were found the same value as background. In this study the estimated annual effective doses to workers were below  $1 \text{ mSv y}^{-1}$ .

## 1. Introduction

Phosphate rock in Iran is used for manufacturing phosphoric acid and different kinds of fertilizers. The radioactivity present in phosphate rock is mainly caused by  $^{238}\text{U}$  and  $^{232}\text{Th}$  series. At this work investigated in this study, phosphoric acid was produced by wet process in which the phosphate rock is converted phosphoric acid and phosphogypsum by reaction with sulfuric acid. The overall objective of this investigation is to provide information to petrochemical plant in Iran about the radiation exposures to workers in the phosphoric acid production plant due to TENORM and to provide methods for reducing these kinds of exposures. Assessment the occupational exposure in this plant is met by consideration of the following exposure pathways: External exposure due to gamma radiation, internal exposure from inhalation of radon and progeny and Internal exposure from inhalation of dust particles.

## 2. Material and methods

This survey was carried out in phosphoric acid production plant in Iran. This plant is considered major producer of phosphoric acid that located in Iran.

The assessment of the external gamma exposure has been carried out in all of the phosphoric acid production process. External gamma measurements were done using portable handheld scintillometer (model GR-130 with Geiger Muller (GM) tube, from Exploranium Co, LTD, Canada). The system was calibrated against a  $^{137}\text{Cs}$  standard and daily checked for stability using a low activity  $0.25 \mu\text{Ci } ^{137}\text{Cs}$  ( $9 \text{ kBq}$ ) radioactive source. The readings are presented in terms of nanosievert per hour  $\text{nSv h}^{-1}$ ). Moreover, the external gamma exposure dose was measured with thermo-luminescence dosimeters (TLDs). The TLDs were installed near the workplaces for 6 months to measure the gamma radiation more accurate. The average background gamma exposure levels ranged from  $70\text{-}110 \text{ nSv h}^{-1}$  were subtracted from the gamma exposure levels.

The Continuous measurements of radon concentrations were taken using ionizing chamber radon monitor (Alpha Guard<sup>™</sup> model PQ 2000 from Genitron Co. Ltd, Germany). Short-lived alpha emitting particles

(radon daughters) were measured using Radon-WL-Meter to obtain the equilibrium factor between radon and its decay products.

Long-lived radio nuclides dust levels were measured by using samplers during normal works at the plant to obtain samples followed by radionuclide analysis to determine dust concentrations. A known volume of air is drawn through a pre-weighed membrane filter paper (47 mm diameter, pore size 5  $\mu\text{m}$ ) by means of an air pump (model MCS from SKC Co, Ltd UK), which is calibrated using a dry gas meter (model DC-HC from BIOS International Co, Ltd USA). On site, the filter holder was placed in a static position at approximately 1.6 m high (breathing zone height). Filter papers were left undisturbed for 3-4 days after their removal from the sampler (to allow for Rn daughters to decay away) before being counted for  $\alpha$  particle activity under a proportional flow counter (model Multi-Low-Level counter FHT 770T from Eberline Co. Ltd USA). Samples were usually taken during an 8-h day-shift.

The specific activity of  $^{40}\text{K}$ ,  $^{226}\text{Ra}$ , and  $^{232}\text{Th}$  in phosphate rock, phosphogypsum, chemical fertilizers and other samples was measured using a Canberra High Purity Germanium (HPGe) detector. Detector is surrounded by a massive lead shield (10 cm) with internal walls of electrolytic copper and cadmium and coupled to a Canberra MCA-Series 100. The system was calibrated with respect to energy and efficiency using reference materials (RGU-1), (RGTh-1) and (RGK-1) that were prepared from International Atomic Energy Agency (IAEA). The relative efficiency of detector is 40% and its energy resolution is 2 keV at full width half maximum (FWHM) from 1332 keV energy of  $^{60}\text{Co}$ . Samples were first dried, weighed (300gr) and then covered securely and placed in polyethylene cylindrical gas-tight containers three weeks prior to counting. At the end of ingrowth's period, the samples were counted for 3-16 h depending on their activity levels.  $^{226}\text{Ra}$  was determined by means of its progeny photo peak:  $^{214}\text{Bi}$  (609 keV).  $^{232}\text{Th}$  was analyzed by means of its progeny photo peak:  $^{208}\text{Tl}$  (583 keV). The activity of  $^{40}\text{K}$  was measured directly through its 1461 keV peak

### 3. Results and discussion

Radionuclide analysis of phosphate rock, phosphoric acid, slurry and chemical fertilizer are presented in Table I. The  $^{232}\text{Th}$  concentrations in all samples were below LLD.  $^{238}\text{U}$  is ranging from 10 to 251  $\text{Bq kg}^{-1}$  that the highest value is in slurry.  $^{40}\text{K}$  is ranging from 112 to 162  $\text{Bq kg}^{-1}$  that the highest value is in phosphate rock. It is necessary to mention that phosphate rock used in this plant contain small amounts of  $^{226}\text{Ra}$  and  $^{232}\text{Th}$  and therefore are not a case of concern from the radio protection point of view.

TABLE I. RADIOACTIVITY CONCENTRATIONS IN SAMPLES

Sample	Mean specific activity ( $\text{Bq kg}^{-1}$ )		
	$^{226}\text{Ra}$	$^{232}\text{Th}$	$^{40}\text{K}$
Phosphate rock	16	-	162
Phosphoric acid	10	-	-
Fertilizer	16	-	112
Slurry	251	-	-

External gamma measurements were done with two instrument types. External gamma dose rate in the plants environs were measured using the portable survey meter. Measured dose rate ranged from

50 nSv h<sup>-1</sup> to 2700 nSv h<sup>-1</sup> in different areas. The maximum dose rates were observed in attack part and seal tanks. Measured dose rate on acid pipes were about 2700 nSv h<sup>-1</sup>, several background measurements have been taken as a control measurement of the natural background (70-100 nSv/h). The average gamma radiation dose was calculated to be less than 0.7 mSv y<sup>-1</sup>. Also the local dose was measured with TLDs that were installed near the work places. These places were: bulk storage, filtration site and attack. The exposure time was considered carefully that on a shift the workers were present for only several hours and minutes at the various working places.

The results for the internal exposure from radon showed that, the concentrations of radon were below 7 Bq m<sup>-3</sup> and they are similar to outdoor radon concentration, so there weren't any radiological significant from the point of view of radon occupational exposure in the plant. In most of the investigated cases of NORM at work places usually refers to the inhalation of contaminated dust as a major pathway by workers. The dustiest locations of the plants were found to be the bulk storage, and filtration site.

The potential radiation doses from inhaled dust are based on the exposure duration (assumed to be 1000 to 2000 h/a) and a standard breathing rate of 1.2 m<sup>3</sup>/h. A default activity median aerodynamic diameter (AMAD) particle size of 5 µm was assumed [1]. According to these assumptions and dose conversion factor of 3.5×10<sup>-6</sup> Sv y<sup>-1</sup> for uranium (uranium and the radionuclide in the dust were in equilibrium) [2], , the total inhaled activity expressed as gross alpha activity in uranium chain were determined [3] and the potential dose from inhaled dust was calculated to be less than 0.336 mSv/a. The results of the calculations are shown in Table II and Fig. 1. Employees working in these areas are required to wear personal protective equipments (PPE) including protective clothing and face dust masks.

TABLE II. OCCUPATIONAL RADIATION DOSE CALCULATED FOR WORKERS IN A PHOSPHORIC ACID PRODUCTION PLANT IN IRAN

Plant	Annual effective dose (mSv)		
	External gamma irradiation	Dust inhalation	Total
Bulk storage	0.258	0.336	0.594
Control room	-	0.038	0.038
Attack	1.3	0.084	1.384
Filtration	0.557	0.109	0.666
Seal tank	1.26	-	1.260
Mean	0.675	0.141	0.788

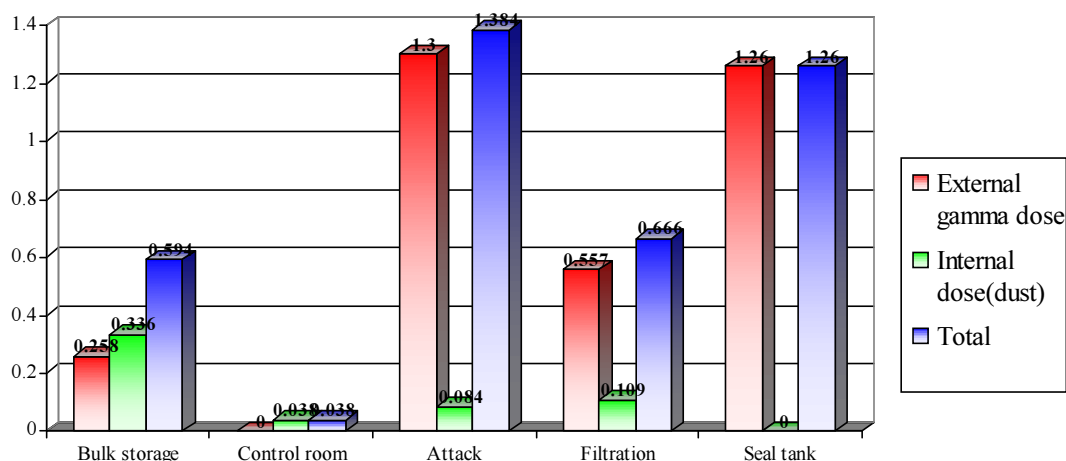

FIG. 1. Mean total annual effective dose received by workers in acid phosphoric plant.

#### 4. Conclusions

The different scenarios for estimating the occupational dose received by workers in the acid phosphoric production plant shows that exposure due to external gamma rays is the most important contribution and after that the exposure due to inhalation of particles is important. As you can see in chart I the mean total annual effective dose likely to be received by a worker involved in the processing of acid phosphoric in petrochemical industry is approximately 0.788 mSv (788  $\mu$ Sv). As it is clear that the reference dose value of 1 mSv/y is not exceeded for these workers. In fact the exposures identified are lower than those recommended for public [1].

#### REFERENCES

- [1] INTERNATIONAL COMMISSION ON RADIOLOGICAL PROTECTION, Protection against Radon-222 at home and at work, ICRP Publication 65, Pergamon Press, Oxford (1993)
- [2] INTERNATIONAL ATOMIC ENERGY AGENCY SAFETY STANDARDS SERIES, Occupational Radiation Protection in the Mining and Processing of Raw Materials, Safety Guide No, RS-G-1.6, Vienna, (2004).
- [3] INTERNATIONAL COMMISSION ON RADIOLOGICAL PROTECTION, Recommendations of the International Commission on Radiological Protection. ICRP Publication 60, Ann. ICRP 21(1-3), Pergamon Press, Oxford (1991)
- [4] EVALUATION OF EXPOSURE TO TECHNOLOGICALLY ENHANCED NATURALLY OCCURRING RADIOACTIVE MATERIALS IN THE PHOSPHATE INDUSTRY, Florida Institute of Phosphate Research (FIPR), Publication No. 05-046-155

# Occupational exposures in the phosphate fertilizer industry located at Huelva (south-western Spain)

J.P. Bolívar<sup>a</sup>, J.P. Pérez-Moreno<sup>a</sup>, J.E. Martín<sup>a</sup>, J.L. Mas<sup>b</sup> and E. Borrego<sup>a</sup>

<sup>a</sup> Department of Applied Physics,  
University of Huelva,  
Campus de El Carmen, 21071 Huelva, Spain. (E-mail: bolivar@uhu.es)

<sup>b</sup> Department of Applied Physics II,  
University of Seville,  
Seville, Spain.

**Abstract.** The Spanish Government implanted the 96/29/EURATOM directive in 2001, where it was regulated the sanitary protection against ionizing radiations. Some applications of these regulatory rules might affect to the industries that are devoted to the phosphoric acid production. This possibility is founded on the presence of high uranium concentrations (about 100-150 µg/g of U) and other radioactive elements in the commercial sedimentary phosphate ore, which is used as raw material by acid phosphoric factories. A major fraction (about 80 %) of uranium present in the phosphate rock is dissolved with sulphuric acid and remains associated to the acid phosphoric and fertilizers. A <sup>238</sup>U-daughter, <sup>226</sup>Ra, is also present in the phosphate rock. This radionuclide, which is important from a radiological viewpoint, is conveyed, associated to the phosphogypsum (PG), to air opened piles around the factories. The PG is a by-product coming from phosphoric acid production that presents high amounts of natural radionuclides such as <sup>226</sup>Ra and <sup>210</sup>Po. Although the origin and distribution of those radionuclides has been well studied, there is a lack of information on the radiation exposure levels in workers of phosphoric acid factories. This paper presents our preliminary results on radioactive doses received (external and inhalation pathways) by workers involved in a phosphoric plant of an industrial complex in Huelva, South-West of Spain. This research must be extended in the frame of a wide research project, where two industrial complexes are studied. Four different plants form the phosphoric acid factory studied. Several sections are considered in every plant according to the chemical process most representative. The external dose rate was measured in every section. The dose rate is expressed as an increment over the natural background level of the surrounding area, being the obtained values generally from 0 to 12 mSv/y. To know the exposition received by workers, of course, previous dose rates have to be corrected by the corresponding occupation factors. In these cases, the occupational factor was around zero, and therefore their dose contributions to workers must be considered negligible. According to our results, the application of the 96/29/EURATOM directive to phosphoric acid industry can affect to occupational factor in some working locations inside the factories. Thus, some specific areas should be considered as controlled zones, e.g. the sections where the filtration processes are developed. However, the outdoor areas around the plant present natural background levels. Then, the own facilities act as a shielding for this radiation sources.

## 1. Introduction

The phosphoric acid production industry has been considered in the last years as one of the most representative examples of NORM (“Naturally Occurring Radioactive Material”) and TENORM (Technologically Enhanced NORM) industrial processors. This fact is based on the high natural radionuclides contents of the used ore, the so-called phosphate rock or phosphorite. This rock accumulates very high concentrations of natural U (in the range of 100-150 ppm) showing natural relative isotope abundances, being <sup>238</sup>U and <sup>235</sup>U in secular equilibrium with their respective daughters. On the contrary, the mass activities of naturally-occurring <sup>232</sup>Th-Series radionuclides are usually quite less than their mass activities in World average soils or in the Earth crusted rocks [1].

A very large industrial complex is placed about 2-4 km away from Huelva town (SW of Spain) being two of these factories devoted to the production of phosphoric acid through the so-called “wet acid process” (see below for details). In these facilities, two sorts of phosphate ores are used: 1) phosphate ore from Morocco, and 2) igneous origin phosphate ore from Kola (Russia). They show several differences on radionuclide contents: the natural radionuclides from the U-Series in Kola samples are well less than those measured on Morocco phosphate rocks. This facility deals usually with Morocco phosphate rock, although also Kola ore is sometimes used. On the contrary, <sup>232</sup>Th-Series radionuclides in Kola samples are higher than in World average soils in a factor up to 3-5.

As a consequence of the Industrial process, secular equilibrium is broken, and the radionuclides suffer redistribution according to their respective chemistries. Thus, it has been shown in the literature that around 80% of the U present in the ore remains concentrated in the phosphoric acid [2]. On the other hand, almost a 90% of Ra and Po isotopes present in the ore remains accumulated in the by-product generated by this process. This by-product has a  $\text{CaSO}_4 \cdot 7\text{H}_2\text{O}$  matrix and it is referred as PG.

From the start-up of the first of these factories in the 1960s decade, more than  $7 \cdot 10^7$  Tonnes of PG have been accumulated in a salt-marshes landscape near the factory, only 300 m away from the surroundings of Huelva town. They were stored there after transportation from the factory using a river water leaching system. Those Gypsum stacks cover an area of approximately 1200 Ha, with an average height above the natural soil of approximately 5-6 m, becoming a well known radiological anomaly. Furthermore, approximately 20% of this Gypsum mass was directly released to the Odiel River. The radiological impact on the close environment of this practice has been previously described [3-4]. In order to minimize the industrial impact on the environment, the involved enterprises recently exchanged the direct release to the river by a recirculation process in which the water used in the Gypsum transport is reutilized continuously. The radioecological benefits of this alternative practice have also been shown elsewhere [5].

Although both the direct impact on environment and the impact on Huelva town inhabitants have been studied with certain detail, there is a lack of knowledge on the radiation exposure to workers involved in the Industrial process. It seems very clear that the continuous exposure to these natural radioactive sources and TNOR materials could cause a very important enhancement of their received doses. They have been considered as General Public to date, and it seems that an *a priori* estimation of their received dose could provoke they become Professionally Exposed Workers. This fact must to be studied under the light of the recently transposed European regulation, which was translated to Spanish regulation through the RD-188 order. According to this regulatory mainframe the effective increment dose must be less than 1 mSv/y; otherwise, the regulatory situation of such workers should be reconsidered.

Such an examination is performed in this work. Section 2 describes the general scheme of the Industrial Process. This is the base for the sampling plan there explained; in the same way, the used methods and materials are described in that section. Section 3 shows the obtained results, which are analyzed in terms of the previously explained regulatory system. Finally, several conclusions arise, which are summarized on Section 4.

## **2. Methods and materials**

### ***2.1. Summary of the industrial process***

The  $\text{H}_3\text{PO}_4$  production process via the wet acid process is based on dissolving the mineral ore through its leaching using  $\text{H}_2\text{SO}_4$ . This process consists of four steps: milling, reaction, filtration and concentration, which are summarized in Fig. 1 (the step 1 was removed in order to make it easy to understand).

#### ***2.1.1. Phosphate ore milling***

The ore is milled using a ball mill. Thereafter a ventilator generated air stream carries the milled phosphate to a separator where only grains with optimum size (0-2 mm particle diameter) are selected. The remaining particles are reintroduced into the milling process. The selected particles are transferred to a cyclone in order to be leached.



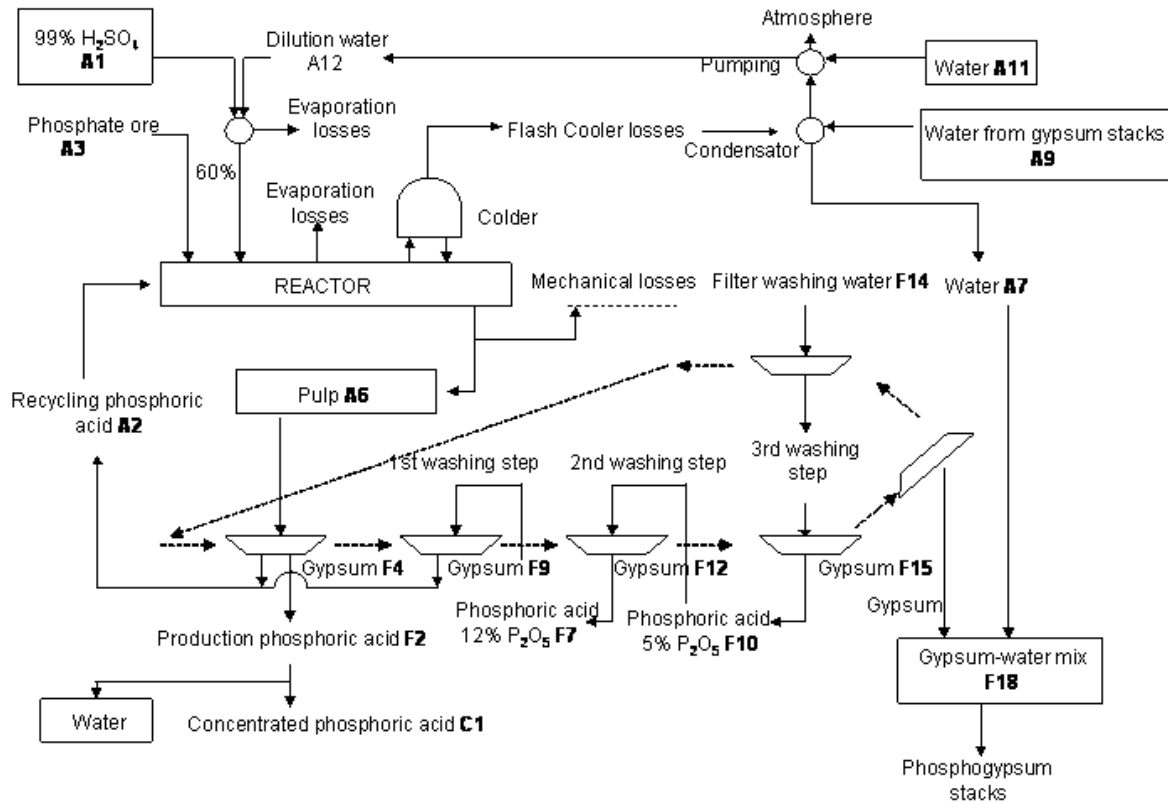
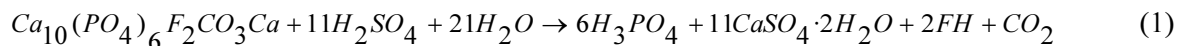

FIG. 1. Scheme of the industrial process of phosphoric acid production

### 2.1.2. Chemical reaction

The fine particles generated in the first step react with 60 %  $H_2SO_4$ , following the exothermic reaction:



This reaction produces the “weak” phosphoric acid (with a  $P_2O_5$  content of 27% w/w) as a pulp, which must be controlled at a temperature of  $72^\circ C$  throughout several recirculation steps, where the PG is generated. The production mass ratio  $P_2O_5$ /gypsum is approximately 1:5.

### 2.1.3. Filtration

The gypsum must be removed from the pulp in order to produce the phosphoric acid. This filtration step is performed using a PRAYON filter, which consists of 24 filtering stages vacuum-controlled. Each of these stages is built on stainless steel, and a synthetic cloth (PPE) resistant to strong acidic materials is supported on its bottom acting as a filter. The separated gypsum is pumped to the storing piles, being the acid sent to the concentration step.

### 2.1.4. Concentration

Firstly, the separated acid is pumped to a decantation cube in order to remove the impurities by precipitation. The concentration is performed in a vacuum controlled heat exchanger, being the acid in recirculation towards two evaporators. After this step phosphoric acid raises to 54 % of  $P_2O_5$ .

Throughout this process, the  $P_2O_5$  contents of both raw material and product change, and so do the radionuclide concentrations. Previous studies [6] have shown the high natural radionuclide concentrations in several of these steps. This is the reason why the dosimetric sampling was especially careful in the locations related with the filtration step.

Due to the differences in natural radioactivity contents between both kind of phosphate ore rocks (i.e., those coming from Morocco against those coming from Kola), the dosimetric sampling was repeated twice. The first one was performed while the Morocco ore was processed at the facility. The second one was performed being the Kola phosphate ore the processed raw material. The reason to repeat the dosimetric sampling is that, as we explained above, there are statistically significant differences in the natural radionuclide concentrations in both kinds of ore; hence it could be expected to find different dosimetric values in the facility depending on the processed ore.

Several workers can also be exposed to the by-product radioactivity during the storing process and the surveillance of the PG piles. Hence, an additional dosimetric sampling was performed there. The increment of dose on the gypsum piles has been already described [7-8], and therefore only the results concerning the recirculation system are to be described here. Two kinds of locations were distinguished: “S” sampling points are referred to locations where the surface is formed by dry PG, which was released there many time ago, and soils. On the contrary, the perimeter channel is surrounding the seawater pond where the PG is being stored at the present day. Their relative positions are shown in Fig. 2.

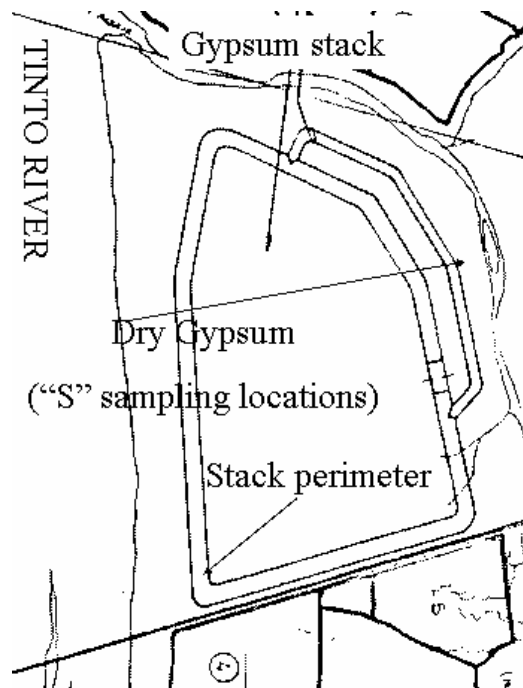

FIG. 2. Diagram of the dose measuring points for the recirculation water pond, at the phosphogypsum stacks.

## 2.2. Dose measurements

External gamma ray dose was performed using a gas flow detector Berthold Umo LB123 coupled to a LB1236 probe, which works under Geiger-Müller regime. All the results were background corrected, including this background the detector noise and cosmic radiation according to the data published elsewhere [9-10]. The instrument was factory calibrated and their performances and calibration are routine, periodically checked. The energy working range is 30-2000 keV, being the effective dose rate range from 50 nSv/h to 10 mSv/h. Each 1-minute measurement, done 1m above the soil, was replicated five times in order to achieve a representative average value. On the contrary, the values recorded during the industrial process were taken one time after detector stabilization.

### 3. Results

#### 3.1. Background

The natural background contribution from photons in soil was measured in several places near Huelva town. The average dose rate was  $0.40 \pm 0.09$  mSv/y (average and mean standard deviation,  $n = 10$ ), [8]. This dose rate is quite similar to other measurements performed in the same geographical location [11-12]; it corresponds to a salt-marshes land with very high contents in  $\text{SiO}_2$ , which results in a relatively low soil dosimetric contribution.

#### 3.2. The factory

Table 1 shows the external dose rates obtained at the facility when both phosphate ores were processed. The data set are background corrected, i.e. apparatus background, background soil contribution and cosmic radiation count rates are subtracted from the shown results.

Several conclusions can be drawn from Table 1:

1. As a general rule, there are no systematic differences in the dose rate values, independently of the processed ore. The results were different in some points in a variable factor ranging 0.5-2 (there are several exceptions, please see below). The more realistic explanation for this fact is that as mentioned above, the Kola phosphate ore contains lower  $^{238}\text{U}$ -Series radionuclides, but  $^{232}\text{Th}$ -Series radionuclides are more concentrated. Thus, it is possible that a potential decrease of the dosimetric effect associated to the first source were biased by the radionuclides associated to the second one. Furthermore, although both phosphate ores are alternatively treated there, that taken from Morocco is the major raw ore. This means that the reservoirs, deposits, pipes and other installation throughout the whole facility could be submitted to some kind of “memory effect”, i.e., an important deposit of radionuclides released from the predominant Morocco ore would establish an imprint or enhanced baseline on the dosimetric contribution throughout the whole process as a contamination background. Hence, the predicted lower dosimetric contribution from Kola ore could be mitigated by the major source from Morocco previously treated at the same facility.
2. An especial difference, however, appears for the values recorded close to the third washing step (6.8-6.9), where when working with Kola ore the effective dose rates were in the range of 4 times less than when the Morocco ore was treated.
3. Usually, the higher effective dose rates were present in those points belonging to the filtration step. This should be due to the close present of dry PG that accumulates the major concentrations of natural radionuclides (those of Ra and Po whom accumulate in the gypsum).
4. A first exploration of the Table reveals that approximately a 42 % of the sampled locations when Morocco phosphate ore was dealt (63 % for Kola phosphate ore, although the number of sampling locations is minor) could potentially be troublesome in terms of the received dose by the workers. In those places, the year overall usual range of effective dose rates was larger than 1 mSv/y. However, the corresponding occupational factor must be accounted: many of those places are only ways from a facility room to another one, and the workers residence time in there is usually very short. In order to assay this possibility, a pessimistic occupational factor of 0.23 (8 hours working a day, five days per week, and 50 weeks a year) has been applied to the previous data set. In this way, it can be concluded that only sampling points 5.4 and 6.3-6.9 for Morocco phosphate ore and 6.4-6.9 for Kola Phosphate ore could produce an increment on effective external dose rate larger than 1.0 mSv/y. At these locations, an occupational factor less than 0.08 must be assured in order to avoid any problem with the present regulation laws. It is necessary to repeat once again that several of these places are associated with a real occupational factor quite less than 0.08 (e.g., locations 6.8-6.9 are out of the operating areas, and therefore the presence of a worker in such points should be exclusively accidental.)

TABLE 1. ENHANCEMENTS OF THE EXTERNAL EFFECTIVE DOSE RATES (nSv/h) DUE TO X- $\gamma$  IRRADIATION REGISTERED AT SEVERAL POINTS INTO THE FACILITY WHEN MOROCCO AND KOLA PHOSPHATE ORES WERE DEALT WITH (Measurement relative uncertainties are in the range of 5-10 %)

Sampling site	Morocco	Kola
1.1 Facility Entrance	0	0
1.2. DAP store	39	N.M.
1.3. MAP store	28	N.M.
1.4. In the way from MAP to FA2	28	N.M.
2.1. Phosphate Rock silo	251	68
2.2. 1 m besides the silo	39	171
2.3.1 m besides ore carrying band	371	N.M.
3.1. 1 m away milled rock pile	39	N.M.
3.2. Same as 3.1.	45	N.M.
3.3. Mill operator cabin	28	51
3.4. Way from Mill to concentrated H <sub>2</sub> SO <sub>4</sub> tanks	51	68
3.5. 1 m away rock dust pipes	91	68
3.6. Same	108	251
3.7. Phosphate ore weighting machine room	39	68
4.1. Above rooms 3-4	102	108
4.2. 2m away reactor rooms 4-5	0	N.M.
4.3. Above rooms 4-5	11	57
4.4. Above reacting pulpe	22	57
5.1. Recycling acid and production acid deposit	136	182
5.2. Above 22% P <sub>2</sub> O <sub>5</sub> acid (recycling acid)	39	171
5.3. 1m besides recycling acid pipes	239	148
5.4. Above deposits, besides production acid pipes	502	410
5.5. Above deposit, besides acid pipe into concentration step	79	182
6.1. Just below the filter	51	102
6.2. 1 m from the pulp entrance to the filter	450	428
6.3. In the way from pulp entrance to the first washing step	770	479
6.4. 1 m from the first washing step (12% P <sub>2</sub> O <sub>5</sub> )	1050	1021
6.5. In the way between washing steps 1-2	730	559
6.6. 1 m away 2nd washing using acid 5% P <sub>2</sub> O <sub>5</sub> contents	987	1130
6.7. In the way from the 2nd to the 3rd washing steps	901	570
6.8. 1 m away from the 3 <sup>rd</sup> washing step (water)	1118	302
6.9. 0.5 m away from the same point	1369	359
7.1. Same than 6.3. but around the filter	171	119
7.2. Same than 6.5. but around the filter	171	136
7.3. Same than 6.7. but around the filter	119	171
7.4. Same than 6.9. but around the filter	102	148
8.1. 2m away from acid concentration area	11	N.M.
8.2. Above the production acid decantation pool	211	N.M.
8.3. Above acid decantation pool	68	N.M.
8.4. 0.5 m above the decantation pool	319	N.M.
8.5. 0.5 m above the AF-2 decantation pool	182	N.M.
9.1. Facility rooftops	39	N.M.
9.2. Laboratory	0	N.M.
9.3. Control room	11	51
9.4. Old control room	0	N.M.

It is important to note that the previous dosimetric discussion has been performed considering only the effects related to external irradiation. However, there are more ways to be given account, such as radionuclide inhalation and intake as dust or aerosol during the industrial process.

### 3.3. The gypsum stacks.

We can compare the previous data set with those dosimetric campaign results performed above the phosphogypsum piles. Several works were devoted in the past to this kind of evaluations [7-8], and therefore only the results concerning perimeter channel and the water pond are to be shown here. These results are summarized in Table 2.

TABLE 2. EXTERNAL EFFECTIVE DOSE RATES FROM X- $\gamma$  IRRADIATION AT SEVERAL POINTS CLOSE TO ACTIVE STACK AND ITS SURROUNDING SOILS (Measurement relative uncertainties are in the range of 5-10%)

Sampling locations	Effective dose Range (nSv/h)	Average (nSv(h))
Stack perimeter	11-308	152 $\pm$ 8
Surrounding soils	11-240	49 $\pm$ 14

From those results, it is clear that even though many points are related to a corresponding high effective dose rate, after application of the previously mentioned occupational factor there is no any associated possibility of overcoming the upper limits suggested by the new Spanish regulations (of course assuming that such occupational factor is not over passed). The high dosimetric values there recorded were in good agreement with those other registered in the close Gypsum stacks area [7-8]. However, the dosimetric implications were usually weaker than those previously mentioned, due to the presence of the recirculation water, which enhanced natural radionuclide contents are lower than those of gypsum.

Hence, a raw reading of the previously mentioned results could arise to the conclusion that, after bearing in mind the corresponding occupational factor, there are no risks for workers involved in the Industrial production of Phosphoric acid. However, some prudence must be kept concerning this conclusion: the only way of radiological impact to workers considered in this work has been the external irradiation. There are several radiation pathways more to consider, such as inhalation of radionuclides as aerosol particles and, especially, radon delivered during the phosphate ore milling and leaching. Although several works have shown the low impact related to both sources over the gypsum stacks [13], the works devoted to their impact into the facility are still under progress.

## 4. Summary and conclusions

Several points in a factory devoted to the production of phosphoric acid have been identified as potentially troublesome from the point of view of the external doses received by the workers. This fact shows 1) the need for periodical revisions of the committed doses to workers and 2) the need for establishing accurate and strictly controlled occupation factors for workers in such places. Kola phosphate ore and Morocco phosphate ore are used in the facility, being the second of them the usual raw ore. No significant external dose rates were registered at the facility depending on the ore used, besides their very different natural radionuclide contents. This fact could be related to an accumulation of radionuclides in several industrial steps during the use of Morocco phosphate rock, which is the dominant raw ore material used in the facility. As these results are referred only to direct external irradiation, deep studies on the radionuclide intake and inhalation are peremptory.

## ACKNOWLEDGEMENTS

This work was partially supported by FEDER contract 1FD97-0900CO2-02, and by a Spanish Security Council (CSN) project from its I+D programme 2004-2007. The authors are also grateful to Mr. José Garralda, FERTIBERIA, S.A. for his kind help in the sampling design and execution.

## REFERENCES

- [1] UNITED NATIONS SCIENTIFIC COMMITTEE ON THE EFFECTS OF ATOMIC RADIATION. Sources, effects and risks of ionizing radiation. New York, United Nations. Sales Publication No E.88:IX.7; 1988.
- [2] BOLÍVAR JP, GARCÍA-TENORIO R, GARCÍA-LEÓN M. On the fractionation of natural radioactivity in the production of Phosphoric Acid by the wet acid method. *J. Radioanal. Nucl. Chem. Lett.* 214, 77-88. (1996)
- [3] BOLÍVAR JP, GARCÍA-TENORIO R, GARCÍA-LEÓN M. Enhancement of natural radionuclides in soils and salt-marshes surrounding a Non-Nuclear Industrial Complex. *Sci. Tot. Environ.* 173/174, 125-136 (1995).
- [4] MARTÍNEZ-AGUIRRE A, GARCÍA-LEÓN M. The distribution of U, Th and <sup>226</sup>Ra derived from the phosphate fertilizer industries on an estuarine system in Southwest Spain. *J. Environ. Radioact.* 22, 155-177 (1994).
- [5] AGUADO JL, MAS JL, SAN-MIGUEL EG, BOLÍVAR JP, PÉREZ JP, GARCÍA-TENORIO R. In Proceedings of the Third Contamination and Toxicology Iberian Congress, Faro (Portugal), 26-30 April 2000 (In Spanish).
- [6] BOLÍVAR JP, GARCÍA-TENORIO R, GARCÍA-LEÓN M. Fluxes and distribution of natural radionuclides in the production and use of fertilizers. *App. Radiat. Isot.* 46, 717-718 (1995).
- [7] MAS JL, BOLÍVAR JP, GARCÍA-TENORIO R, AGUADO JL, SAN MIGUEL E.G., GONZÁLEZ-LABAJÓ J. A dosimetric model for determining the effectiveness of soil covers for phosphogypsum waste piles. *Health Physics* 80(1), 34-40 (2001).
- [8] MAS JL, SAN MIGUEL EG, BOLÍVAR JP, ET AL. An assay on the effect of preliminary restoration tasks applied to a large TENORM wastes disposal in the south-west of Spain, *Science of the Total Environment* 364, 55-66, 2006.
- [9] UNITED NATIONS SCIENTIFIC COMMITTEE ON THE EFFECTS OF ATOMIC RADIATION, UNSCEAR 1993 Report to the General Assembly, New York, United Nations. Sales Publication Sales No. E.94.IX.2. ISBN 92-1-142200-0
- [10] Berthold Umo LB123: User manual.
- [11] CANCIO D. (1998) Revisión de la situación radiológica en la zona de vertidos de la industria de fosfatos en Huelva. Informe del Ciemat para CSN. (In Spanish).
- [12] QUINDÓS PONCELA L. S., FERNÁNDEZ P. L., GÓMEZ AROZAMENA J., SAINZ C., FERNÁNDEZ J. A., SUAREZ MAHON E., MARTIN MATARRANZ J. L., CASCÓN M. C. Natural gamma radiation map (MARNA) and indoor radon levels in Spain, *Environment International*, 29, 1091-1096 (2004).
- [13] MAS JL, BOLÍVAR JP, SAN-MIGUEL EG, GARCÍA-TENORIO R, AGUADO JL, GONZÁLEZ J AND PÉREZ JP. In Proceedings of the Third Contamination and Toxicology Iberian Congress, Faro (Portugal), 26-30 April 2000 (in Spanish).

# Phosphogypsum as a building and construction material in tropical countries — radiological implications

V.M. Jacomino<sup>a</sup>, W. Britto<sup>a</sup>, M. Canut<sup>b</sup>, M.I. Yoshida<sup>b</sup>

<sup>a</sup>Development Center of Nuclear Technology  
Belo Horizonte, Minas Gerais  
Brazil

<sup>b</sup>Federal University of Minas Gerais  
Belo Horizonte, Minas Gerais  
Brazil

**Abstract.** In phosphate processing, radium and its decay products are the naturally occurring radioactive materials that are encountered. The radium is present in the original phosphate rock, and passes through without change into the phosphogypsum, which is a by-product of the phosphoric acid industry that is obtained by reacting phosphate rock with sulphuric acid. Because of the weight of sulfuric acid added to the rock to extract the phosphate, the amount of NORM per kilogram of gypsum is less than the amount per kilogram of phosphate rock. In way to contribute for the relative regulation of the handling and use of phosphogypsum as basic input, the determination of the concentration of natural radionuclides was made, as well as the determination of the exhalation rate of <sup>222</sup>Rn in samples containing different proportions of materials used in the construction industry of Brazil. The work methodology was elaborated based in the needs for a characterization of phosphogypsum. The evaluations of the physical and chemical properties of phosphogypsum were performed through thermal analyses (DTA and TGA); X-rays Fluorescence (XRF) and X-rays Diffraction (XRD). Additional analyses were carried out in order to measure natural radioactivity concentration in different types of samples, as well as the radon exhalation rate. The results showed that the phosphogypsum presents the largest values of concentrations of radionuclides associated to the natural series of <sup>232</sup>Th. The concentration of <sup>226</sup>Ra present in the samples varied from 105 to 506 Bq/kg, the <sup>232</sup>Th from 103 to <sup>232</sup>Bq/kg and the <sup>40</sup>K varied from 205 to 258 Bq/kg. The exhalation rate of <sup>222</sup>Rn varied from 0.223 to 0.376 Bq/m<sup>2</sup>.min. The final stage of the study evaluated the estimate of the radon concentration inside a typical room with dimensions of (4x4x2.80 m). The results presented values below the reference level adopted by legislation (148 Bq/m<sup>3</sup>).

## 1. Introduction

The main raw materials of the acid phosphoric national industry are the apatite ores coming from phosphoric rocks, either sedimentary, igneous or metamorphic origins which frequently contain significant amounts of uranium, thorium and other radioactive elements of their respective decay chains [1]. The radionuclide concentrations in each rock are greatly variable, basically depending on the geological characteristics of the place of origin.

In the phosphoric rocks, the several members of the natural series of <sup>238</sup>U and <sup>232</sup>Th are in radioactive equilibrium. After the digestion of the rock in plants that use the wet process for the production of fertilizers, the balance is broken, with a redistribution of radionuclides taking place. Approximately 86% of the <sup>238</sup>U and 70% of the <sup>232</sup>Th are incorporated into the fertilizer, while 80% of the <sup>226</sup>Ra that has behavior similar to calcium, and go to phosphogypsum [2].

An important factor is related to the disposal of phosphogypsum in piles, once there is a chance of erosion with the consequent compromising of its stability. Although several authors have published different methods for the removal of fluorides, heavy metals and radionuclides of the phosphogypsum, these methods are proven economically unviable [3]. Studies of characterization of part of the phosphogypsum stocked in the industries of fertilizers in general, showed concentrations in varying from 22 to 729 nBq.kg<sup>-1</sup> of <sup>226</sup>Ra, 11 to 152 Bq.kg<sup>-1</sup> of <sup>232</sup>Th and smaller than 52 Bq.kg<sup>-1</sup> of <sup>40</sup>K [4].

Researches accomplished in several countries around the world have demonstrated the possibility of the potential use of this product as an agricultural source of calcium and sulfur as a conditioner for soils that contains high levels of sodium in the construction of highways and as a substitute for the traditional Portland cement in the production of cement blocks, linings for roofs and prefabricated panels [5].

With the intention of wisely regulating phosphogypsum as a substitute for natural gypsum in commercial buildings and civil construction in Brazil, a research project was conducted by a partnership of the Development Center of Nuclear Technology (CDTN), the Chemistry Department of the Federal University of Minas Gerais and the Materials and Civil Construction Engineering Department of Federal University in Minas Gerais State. The goal of this project was to perform a characterization of phosphogypsum produced by the Brazilian acid phosphoric industry and to compare the results with those of natural gypsum.

The present paper presents the results obtained in the first stage of the research, which included the study of the physical and chemical properties of PG and natural gypsum, as well as the determination of natural radionuclides concentration of these materials. The preliminary results showed that phosphogypsum can be processed to become a viable substitute for gypsum.

## **2. Material and methods**

### **2.1. Materials**

All the analyses were carried out with three different material samples, which enabled comparisons of the results. These three material samples are described below:

- **raw phosphogypsum** - the samples remained in the same state as when collected at the plant, and were not exposed to any treatment
- **treated phosphogypsum** – heated in an electrical oven at 60°C for 24 hours, then sieved and heated at 160°C for one hour; and
- **natural gypsum** – acquired material composite used in civil construction from the commercial market.

Phosphogypsum is a chemical compound that consists mainly of calcium sulfate dehydrate ( $\text{CaSO}_4 \cdot 2\text{H}_2\text{O}$ ) and some impurities. Its physical and chemical properties are comparable to those of natural gypsum [2]. The samples of PG applied in this study were collected from one fertilizer plant. The phosphate rocks used at this plant are out of igneous rock from the Tapira Alkaline Carbonatite Complex, which is situated in the Southeast of Brazil, in Minas Gerais State. This plant manufactures fertilizer by a dehydrate processes.

Natural Gypsum is a very soft mineral composed of calcium sulfate dihydrate ( $\text{CaSO}_4 \cdot 2\text{H}_2\text{O}$ ). Heating gypsum to between 100°C and 150°C (302°F) partially dehydrates the mineral by driving off exactly 75% of the water contained in its chemical structure [6]. The temperature and time needed depend on ambient partial pressure of water. The reaction for the partial dehydration is:



The partially dehydrated mineral is called calcium sulfate hemihydrate or calcined gypsum (commonly known as plaster of Paris) ( $\text{CaSO}_4 \cdot \frac{1}{2}\text{H}_2\text{O}$ ).



## **2.2. Determination of the physical and chemical properties**

As mention above the evaluations of the physical and chemical properties of were performed though (DTA and TG); X-ray Fluorescence (XRF and X-ray Diffraction (XRD) analyses.

The thermal analyses (DTA and TG) were conducted to observe the behavior of the materials when the temperature increased. Differential Thermal Analysis (DTA) shows the transition phases, endothermic or exothermic, of the materials when temperature increased. These behaviors are due to the change of phases, dehydration, oxidation and other chemicals reactions. Thermogravimetry (TG) measured the weight loss or weight gain of a material over a range of temperatures. These analyses suggested the heating temperature of PG necessary. A NETZSCH model STA409EP thermoanalyser was used, and the heating gradient was 10°C/min.

X-ray fluorescence analyses were a non-destructive method used to define material's chemical elements. The tests were conducted with a PHILIPS, PW-2500.

X-ray Diffraction analyses were used to analyze the crystalline structures of materials. Seven difratometric sheets (showing Bragg patterns) were prepared and 28 crystalline phases were identified. All The analyses were carried out by the use of a Rigaku difratometer, model Geigerflex.

## **2.3. Measurements of natural radionuclide concentrations**

The natural radionuclide concentration measurements were performed by gamma spectrometry analysis. An HPGe detector with beryllium window of 0.5 mm of thickness and resolution of 570 eV for the level of 122 keV was used. The detector was shielded from external radiation by a lead wall (105 mm thickness), a copper wall (2 mm) and a Lucite wall (4 mm). The detector and the counting geometry were calibrated with reference sources RGU-1, RGTh-1 and RGK-1, which are certified by the International Agency of Atomic Energy. Besides, the calibration of the system was made with a solution mixture (ML1) for calibration of *Physikalisch-Technische Bundesanstalt Braunschweig, Germany*. The emission gamma spectrum was analyzed using the commercial software GAMMAW®. The radioactivity concentration of each radionuclide of interest was estimated from their parent or daughter energy peak intensities.

## **2.4. Measurements of radon exhalation rate**

In order to evaluate the possibility of use of the phosphogypsum as a substitute of gypsum in the cement production, blocks, mortars and plates for lining, test samples were manufactured (cylinders of 5 cm of diameter and 15 cm of height) with different proportions of materials used in the construction industry in Brazil. The composition of each one is shown in Table I This stage of the work has been perfected in order to obtain an ideal composition according to the normative specifications.

The radon exhalation rate of a material containing radioactive elements of the natural series of  $^{238}\text{U}$  and  $^{232}\text{Th}$  is defined as being the radon activity emitted by unit of area of the surface by unit of time ( $\text{Bq}/\text{m}^2.\text{s}$ ). This greatness varies directly with the concentration of  $^{226}\text{Ra}$  present, the thickness, the density and the porosity of the material [7].

Initially, each test sample was put in a glass camera of  $480\text{ cm}^3$  volume, connected to a monitor of radon AlphaGuard® type. The radon exhalation rate was calculated starting from the results of radon concentration in the air in balance with its decay daughters. During the whole analysis period, the glass camera operated at atmospheric pressure, in a way to guarantee the non interference of the present radon in the normal atmosphere of the laboratory in the final result, as well as to prevent the leaking of the radon emanated by the material to the external atmosphere. Before starting the measurement, the camera was ventilated with atmospheric air and then sealed. From then, the increase of the radon concentration in the

camera, according to time, was observed until a balanced condition had been reached. The rate of radon exhalation was calculated based in the results of the radon concentration in the remaining air inside the glass camera after the balance condition had been reached.

TABLE I. COMPOSITION OF EACH TEST SAMPLE.

Identification	Composition
1	128,6 g of Ari Plus cement 300 g of phosphogypsum 1266,4 g of sand 385 ml of water
2	33,34 of Ari Plus cement 300 g of phosphogypsum 1000 g of sand 350 ml of water
3	20 g of white cement 180 g of phosphogypsum 180 ml of water
4	33,34 g of CPE-32 cement (high-early-strength Portland cement) 300 g of phosphogypsum 1000 g of sand 300 ml of water
5	100 g of CPE-32 cement 233,34 g of phosphogypsum 1000 g of sand 300 ml of water

### 3. Results and discussions

#### 3.1. Thermal analyses

The results of thermal analyses indicated that the raw phosphogypsum must be treated to obtain the same mineralogical properties of the gypsum used in the construction industry. Attaining the same mineralogical properties is considered necessary for two reasons: First, this will ensure that the PG is of the anhydrous gypsum form that will develop the desired mechanical structures during the hydration reaction. Second, the treated PG will be valuable in the current processing and marketing structure.

The results of the thermogravimetric analysis of the raw phosphogypsum sample showed that the loss of mass was approximately 33%, which is mainly due the loss of water, both free and structural. The loss of mass was 24 % higher for raw phosphogypsum, than for the natural gypsum sample. This can be explained by the high water content of raw phosphogypsum.

The results proposed a heating temperature to which phosphogypsum should be subjected in order to obtain similar physical properties to those of gypsum. The heating temperature found is proximally 160°C.

### 3.2. X-ray fluorescence analyses

The main group of chemical elements found by the X-ray fluorescence analyses in the each of the three samples was similar. The small differences found are due to the impurities (Na, Ce, Ti, La, K, Zr, and Pr) found in the phosphogypsum samples (Table II).

The small quantities of phosphorous (P) in phosphogypsum samples are due to the presence of this element in the fertilizer production.

TABLE II. RESULTS OF THE X-RAY FLUORESCENCE ANALYSES

Sample	Main elements	Medium elements	Small elements	Traces
Natural Gypsum	S, O	Ca		Si, Al, Mg, K, Zn, Cu, Fe, Mn, Sr
Raw Phosphogypsum	S, O	Ca	P	Si, Al, Mg, Na, Fe, Ce, Ti, La, K, Sr, Zr, Pr
Treated Phosphogypsum	S, O	Ca	P	Si, Al, Mg, Na, Fe, Ce, Ti, La, Sr, Pr

### 3.3. X-ray diffraction analyses

The results of X-ray Diffraction Analyses show that the main crystalline compounds found in phosphogypsum and natural gypsum samples were gypsum ( $\text{CaSO}_4 \cdot 2\text{H}_2\text{O}$ ) and bassanite ( $\text{CaSO}_4 \cdot 0.5\text{H}_2\text{O}$ ), respectively. The raw phosphogypsum consist mainly of gypsum ( $\text{CaSO}_4 \cdot 2\text{H}_2\text{O}$ ). When exposed to heating, phosphogypsum mineralogical composition changes to a higher concentration of bassanite ( $\text{CaSO}_4 \cdot 0.5\text{H}_2\text{O}$ ).

### 3.4. Radioactivity analyses

The results of the natural radioactivity concentration analyses of each one of the materials studied are listed in Table III. The results of the analyses of total thorium and uranium content present are shown in Table IV.

TABLE IV. NATURAL RADIOACTIVITY CONCENTRATION RESULTS

Samples	Radioactivity Concentration (Bq/kg)					
	$^{226}\text{Ra}$	$^{210}\text{Pb}$	$^{228}\text{Ra}$	$^{224}\text{Ra}$	$^{212}\text{Pb}$	$^{212}\text{Bi}$
Raw Phosphogypsum	467 + 10	367 + 5	224 + 15	208 + 6	216 + 3	231 + 10
Treated Phosphogypsum	586 + 14	395 + 5	266 + 12	257 + 6	267 + 3	273 + 8
Natural gypsum	2 + 1	4 + 2	< 3	< 3	< 3	< 3

TABLE V. TOTAL URANIUM AND THORIUM CONTENT PRESENT IN EACH OF THE ANALYSES SAMPLES

Samples	Content [ $\mu\text{g/g}$ ]	
	Total Uranium	Total Thorium
Raw Phosphogypsum	$5.0 \pm 2.3$	$55.5 \pm 3.6$
Treated Phosphogypsum	$5.2 \pm 1.7$	$65.9 \pm 3.0$
Natural gypsum	$< 0.2$	$< 0.7$

Radioactivity concentrations in phosphogypsum are much higher than those observed in natural gypsum samples. The same behavior was observed for the uranium and thorium content. The content of thorium obtained in phosphogypsum samples was much higher than the content of uranium. This can be explained by the fact that Brazilian phosphate rocks are from igneous phosphates deposits, which are normally formed by the extrusion of magmatic material. Compared to sedimentary rocks, igneous rocks usually contain relatively high levels of rare earth metals such as lanthanide and cerium [8].

### 3.5. Radon exhalation rate

The results of the radon exhalation rate for each of the test sample built with different proportions of materials used in the construction industry in Brazil are showed in Fig.1. Assuming a typical Brazilian room (4x4x2.8 m) constructed from raw materials with the exhalation rates given in Fig. 1, and an air-exchange rate of 0.5/h, the maximum radon concentration for each situation is showed in Table VI.

According to the results the test sample (number 03) fabricated with white cement is the one with the highest radon exhalation rate, and consequently the one that presents the maximum indoor radon concentration ( $77.3 \text{ Bq/m}^3$ ). It must be pointed out that this is the most expensive cement used in Brazil, so it is not the most appropriate to build popular houses. The other ones showed final results in the range of  $39.5$  to  $50.8 \text{ Bq/m}^3$ , which are much lower than the  $150 \text{ Bq/m}^3$  recommended action level [9].

TABLE VI. INDOOR RADON CONCENTRATIONS FOR EACH TEST SAMPLE

Identification	Radon Exhalation ( $\text{Bq/m}^2 \cdot \text{min}$ )	Indoor Radon Concentration ( $\text{Bq/m}^3$ )
1	0,242	49.8
2	0,247	50.8
3	0,376	77.3
4	0,223	45.9
5	0,192	39.5

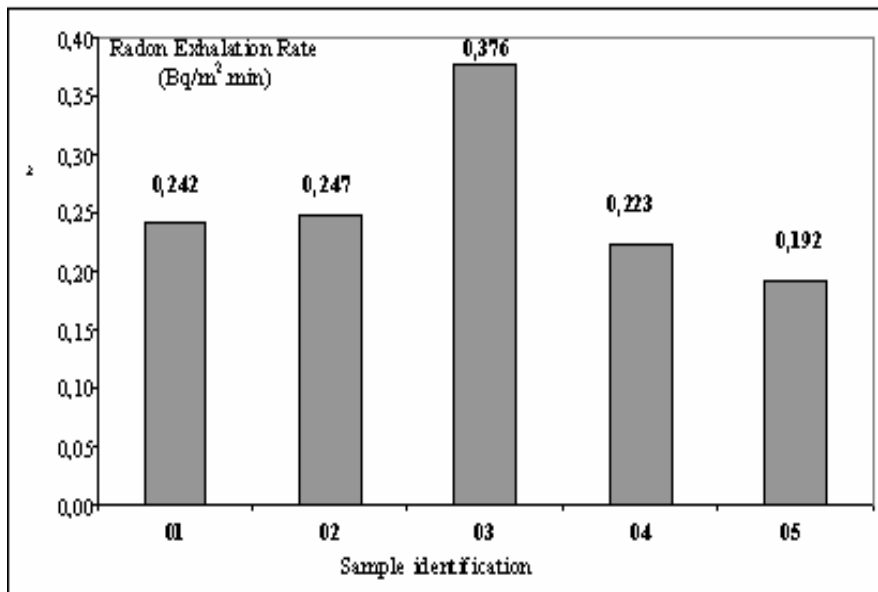

FIG. 1. Radon exhalation rates for test samples built with different proportions of materials used in the construction industry in Brazil

#### 4. Conclusions

In order to evaluate the suitability of phosphogypsum in industrial processes where natural gypsum has heretofore been used, we have in this study performed an exhaustive characterization and comparison of physical and chemical properties of naturally occurring gypsum vs. those of both raw and treated phosphogypsum. Results of these studies show that physical and chemical properties differ:

- Phosphogypsum contains small quantities of trace elements (Ce, Ti, La, Sr, Zr, and Pr) not present in as high concentrations in natural gypsum. Phosphogypsum is enriched in sodium;
- The main crystalline compounds found in the phosphogypsum and gypsum samples were gypsita ( $\text{CaSO}_4 \cdot 2\text{H}_2\text{O}$ ) and bassanite ( $\text{CaSO}_4 \cdot 0.5\text{H}_2\text{O}$ ).
- Water content may vary widely, with levels highest in untreated phosphogypsum;
- The radioactivity concentration in phosphogypsum was much higher than those observed in natural gypsum samples. The same behavior was observed for uranium and thorium;
- The results of radon exhalation rates for proof bodies fabricated with different raw materials, including phosphogypsum, showed that the indoor radon concentration in a room of (4x4x2.8m) built with these materials is much lower than the recommended action level ( $150 \text{ Bq/m}^3$ ), with the exception of the one manufactured white cement.

The results of the tests presented in this paper suggest that physicochemical differences between phosphogypsum and the naturally occurring and conventionally processed gypsum are small and due primarily to differences in thermal history. Thus small refinements in processing phosphogypsum may lead to a base material equivalent to the natural product.

The levels of radioactivity obtained in both raw and treated phosphogypsum samples were at the same levels of those obtained in the literature [1,4]. Additional studies are being carried out in order to evaluate the radon levels in house totally built with phosphogypsum blocks taking into account the normal standards of living in a tropical country as Brazil.

#### REFERENCES

- [1] LONDHE, V. S.; RAO, S. R., Study of Distribution of Some Natural Radionuclides on Processing of Rock Phosphate, *Bulletin of Radiation Protection*. **1**, 4 (1998) 5.
- [2] MAY, A.; SWEENEY, J.W. Assessment of Environmental Impacts Associated with Phosphogypsum in Florida. Department of the Interior, Bureau of Mines, Report of Investigations 8639 (1992).
- [3] RUTHERFORD, P.M.; DUDAS, M.J.; SAMEK, R.A., Environmental Impacts of Phosphogypsum, *The Science of the Total Environment*. **149** (1994), 39.
- [4] MAZZILLI, B.; PALMIRO, V.; SAUEIA, C.; NISTI, M.B., Radiochemical Characterization of Brazilian Phosphogypsum, *Journal of Environmental Radioactivity*. **49**, 4 (2000) 9.
- [5] UNITED STATES ENVIRONMENTAL PROTECTION AGENCY, Potential Uses of Phosphogypsum and Associated Risks: Background Information Document, EPA 402-R92-002. USEPA, Washington, DC (1992).
- [7] CHAU, N. D.; CHRUSCIEL, E.; PROKÓLSKI, L., Factors Controlling Measurements of Radon Mass Exhalation Rate., *Journal of Environmental Radioactivity*, **82**, 3 (2005) 15.
- [8] Bureau of Mines, Minerals Yearbook 1990, Washington, US Bureau of Mines, **1** (1990):
- [9] UNITED NATIONS SCIENTIFIC COMMITTEE ON THE EFFECTS OF ATOMIC RADIATION, Sources and Effects of Ionizing Radiation, UNSCEAR, New York, (2000).

# Remediation interventions in Italian industrial sites contaminated with NORM from the phosphate industry: law provisions, criteria and methods

M. Paganini Fioratti<sup>a</sup>, L. Magro<sup>a</sup>, C. Nuccetelli<sup>c</sup>, S. Risica<sup>c</sup>, C. Simeoni<sup>b</sup>, G. Torri<sup>a</sup>,  
R. Trevisi<sup>b</sup>

<sup>a</sup>APAT (Agenzia Nazionale Protezione dell'Ambiente e Servizi Tecnici)  
Rome, Italy

<sup>b</sup>ISPESL (Istituto Superiore per la Prevenzione e la Sicurezza sul Lavoro)  
Rome, Italy

<sup>c</sup>ISS (Istituto Superiore di Sanità)  
Rome, Italy

**Abstract.** In Italy from the end of the '50s up to the early '90s, some industrial plants located by the sea processed huge quantities of phosphorites for phosphoric acid production. Phosphogypsum wastes – such as slurry - were produced at a rate of some  $10^5$  t  $y^{-1}$  and disposed of in the sea until the mid '70s. After that phosphogypsum was collected in wide landfills within, or close to, the industrial areas. The problems to be faced when designing a remediation intervention for sites like these, where past work activities have left heavy environmental contamination and a huge quantity of wastes, can be summarised as follows: i) industrial plant decommissioning; ii) waste management; iii) landfill management; iv) radiation protection of the population and workers involved in the intervention; v) environmental protection; vi) law requirements relevant to chemical and radioactive contamination. A short review will be presented concerning sites and industrial plants in Italy for which the Ministry of the Environment has asked APAT, ISPESL and ISS - technical bodies entrusted with radiation protection tasks - to analyse remediation plans. Since the procedures to be followed were not yet determined, and the agreements to be reached were rather complex, the spontaneous creation of a working party among experts of the three institutes in order to issue joint official advices has been a new and highly positive experience.

## 1. Introduction

With the Title VII of the European Basic Safety Standards Directive (BSS) [1] the European Commission provided an overall frame and general criteria for the protection from natural radioactivity, mainly radon in workplaces and industrial activities involving NORM. In Title IX, general criteria is set forth regarding cases of lasting exposure resulting from past work activities both with artificial radionuclides and NORM. In the following years the Commission published two guides to assist the transposition of Title VII of the BSS regarding NORM, namely, Radiation Protection 95 [2] about reference levels for workplaces processing NORM, and Radiation Protection 122-part II [3] about clearance levels for these industrial processes. A further guide, Radiation Protection 124 [4], suggests how to remediate areas affected by lasting radiation exposures. In spite of these attempts, the Commission does not consider the implementation of Title VII and Title IX of the BSS Directive to be well harmonized among European Countries. This is one of the reasons why a new draft of the Directive is under discussion. However, when a country faces the need of remediation of sites with past industrial processes with NORM it usually prioritises national health and environmental goals, balancing the exposure of workers/population against total or partial recovery of the territory. In the following we describe some initial Italian experiences on remediation of sites with past phosphoric acid production plants.

## **2. Italian legislation**

### ***2.1. Remediation interventions in NORM-contaminated sites***

In Italy three decrees [5,6,7] that transpose the relevant European Directives [1] provide for legislation concerning the use of ionising radiation.

The Decree of May 2000 [6] first regulates work activities with NORM and requires a preliminary radiological survey for a number of work activities of concern. If the estimated effective doses for workers and the population are higher than the stated action levels (0.3 mSv/y for the general population and 1 mSv/y for workers), the managers are required to adopt a remediation programme to reduce the radiological impact.

The rules concerning remediation interventions, both for artificial sources and NORM, are set forth in the articles 115 – bis and 126 – bis of the above decree of May 2000 [6] and they apply to emergency conditions and to long-lasting exposures due to past practices or past work activities that left contamination and sources of exposure without any form of control. This is the current situation of all the chemical installations for phosphoric acid production in Italy. In fact:

- a. production was stopped during the early '90s;
- b. industrial installations, landfills and wide areas still have rather high NORM contamination levels;
- c. new managements (with completely new identities) were established in order to face the problems deriving from the need for a non-radiological remediation of the sites and from the requirement to comply with the new legislation.

As regards interventions for remediating long lasting exposures due to past work activities with NORM, the cited articles state the following general criteria.

1. Justification: an intervention can be implemented only if the reduction in the health detriment due to exposures to ionising radiation is justified, accounting for both the detriment and the cost of the intervention.
2. Optimization: the overall project for the intervention should be optimised.
3. Usual dose limits for workers must be respected.

The Italian rules, however, do not establish effective dose thresholds and related action levels for the general population in order to state when a remediation intervention is absolutely required or advisable, or when it is to be excluded. This is due to the wide range of situations that can be met and faced, taking into account social factors and the influence of public opinion.

In case of lack of specific national rules, reference should be made to international standards or recommendations. In this case ICRP Recommendation 82 [8] clearly indicates that if members of the public are likely to receive an annual effective dose higher than 10 mSv, then the intervention is almost always justified. This ICRP statement was endorsed by EU [4] and IAEA [9]. Moreover, the Radiation Protection 124 Guideline [4] reports that "... ICRP and IAEA both leave the possibility open that remedial activities are undertaken at lower doses, if they are justified." Presently no international agreement has been found for lower doses.

### ***2.2. Landfills for residues with chemical contamination***

The Italian Decree 152/2006 [10], which replaces the former relevant Decree 471/1999 [11], constitutes the core of the Italian legislation concerning landfills containing chemically and biologically contaminated residues. This Decree establishes rules for planning criteria in order to avoid the spreading of contamination outside the landfill, in rainfall waters and in ground water, in the surrounding environment and in the sea. Rules are given for the choice of the site, the materials to build the separation walls, the chemical treatment of rainfall water percolating through residues in the landfill. Features such as capping materials and their thickness, or the criteria to be adopted for capping are detailed in the cited Decree, together with rules regarding the surveillance and control of the landfill.



A major lack to be stressed lies in the fact that approaches to regulate chemical, biological and radiological risks do not consider that all these forms of contamination are likely to occur in the same material, environment or matrix. Some rules to be followed or means to be adopted for remediation could be in contrast. This is exactly the current situation for remediation interventions concerning plants that used phosphatic ores to produce phosphoric acid, where materials and matrices show both chemical and radioactive contamination. The relevant Administrations, whose advice is required for the approval of interventions, are separate bodies, that must comply with the requirements of the different laws in a harmonized way.

### ***2.3. Competent authorities and bodies***

In Italy the *Ministry of the Environment and Protection of the Territory and the Sea* is the leader authority when it comes to planning an intervention to remediate chemically and biologically contaminated landfills.

As for safety and radiation protection aspects, the Ministry of the Environment relies on the following three Institutes:

1. APAT (Italian Agency for Environmental Protection and Technological Services);
2. ISPESL (National Institute for Occupational Prevention and Safety);
3. ISS (National Institute of Health).

These three Institutes, as regards the radiation protection both for workers and the general population, have different and quite long stories; ISS and ISPESL are the leading technical and scientific bodies of the Italian National Health Service; their main activities are research, control and training in public and workers' health, respectively. APAT's tasks mainly regard licensing and surveillance of nuclear and radiological plants, and the analysis and evaluation of environmental contamination.

Since almost all the sites requiring remediation interventions are located by the sea, ICRAM (National Institute for Scientific and Technological Sea Research), often in cooperation with APAT, is entrusted with the task of planning a representative sampling of sediment, sea water, seaweed, seafood, fish, sands and soil for the relevant area. The measurements on samples are usually done by qualified laboratories under APAT's surveillance.

Municipality and Province Administrations, together with ARPA (Regional Agency for Environment Protection) and ASL (Local Health Units) officers can be entrusted with specific tasks, usually concerning surveys on chemical and biological contamination.

Public opinion and some local organizations and action groups are often involved by local administrations in analysing and evaluating site contamination and plans for remediation.

## **3. Plants to be decommissioned and sites requiring remediation**

### ***3.1. Some features of the Italian plants using phosphatic ores with significant NORM concentration***

Some Italian chemical industries used to produce large amounts of phosphoric acid by processing phosphorites, contained in phosphatic ores coming from Morocco, Tunisia, Togo, Florida (USA), Canada, Chile, etc. The content of natural radionuclides in this kind of raw material varies widely depending on the origin of the rocks [12]. For example, in Italian plants dose rates have been recorded at 1 m distance from soils contaminated by phosphorites, which ranged from background values - typically between 90 – 110 nGy/h [13] - up to 430 nGy/h, depending on activity concentration in NORM.

Chemical installations for phosphoric acid production were built by the sea, in one case at a very short distance from Venice, one of the most amazing cities in the world, and in other cases near archaeological or quite interesting natural sites. These plants kept running from the late '50s up to the early '90s. Afterwards some were completely converted to the production of fertilisers directly from phosphoric acid, or reshaped for the manufacturing of wholly different products.

In the past years a tentative survey was carried out in order to collect data about working activities with NORM by sending a questionnaire to the potentially involved companies [14]. As a point of fact, it is still very difficult to collect exhaustive and official information concerning:

1. how many plants were actually active for this kind of production that used phosphorites;
2. how many tons/y of phosphorites were used;
3. how many tons/y of phosphogypsum residues were discharged into the sea;
4. how many tons of phosphogypsum residues were gathered in landfills during the whole period of production.

Nevertheless, with the available information we may summarise the characteristics of the two plants analysed in this paper:

1. phosphorite consumption: 350– 400  $10^3$  t/y;
2. type of process: mainly Prayon – wet process;
3. production of phosphoric acid: 60 - 100  $10^3$  t/y;
4. production of slurry: 300  $10^3$  t/y;
5. the concentration of phosphogypsum in the slurry was 10 – 20 %;
6. for at least two decades phosphogypsum was discharged directly into the sea, at some 100 m off the coast;
7. since the late '70s in some plants phosphogypsum residues were collected in landfills through pipes with water circulating in a closed circuit;
8. from a radiological point of view, no particular care was taken of these landfills until the issue of the Decree n. 241/2000 [6] that transposes European Directive 96/29 [1];
9. as for other plants, some components of the installation were decommissioned (in any case before the issue of the Decree n. 241/2000); some other components were recycled or reused.

### 3.2. Sites under analysis

A short review will be presented here concerning sites and industrial plants for which the Ministry of the Environment has asked APAT, ISPESL and ISS to analyse plans for remediation in terms of radiation protection. Owing to obvious privacy requirements, all identification data have been omitted. The common characteristics for this type of installations have been listed in paragraph 3.1.

#### 3.2.1. Site A

Site A and annexed installations are within the premises of a refinery and related industrial area.

The installations included in the remediation plan are:

1. one plant for phosphoric acid production, to be decommissioned;
2. three phosphorites stores, to be demolished;
3. four phosphoric acid tanks, to be decommissioned;
4. two pipes to transport slurry from the production plant to the phosphogypsum landfill and water from the landfill to the plant;
5. one phosphogypsum landfill, located a few kilometres from the plant and a few hundred metres off the seacoast.

1. **The plant for phosphoric acid production** is a 6-storey building, 500 m<sup>2</sup> wide and 27 m high (see fig. 1 and 2); acid production started in 1967 and stopped in 1992; effective dose rates from activity concentration in scales have been measured and showed wide range variations. A new plan for decommissioning has to be presented (see par. 4).

2. **Three phosphorite stores** (see fig. 3) – a total of 150 000 m<sup>3</sup>, presently empty - and surrounding area; phosphorites left on the ground have been gathered and put in a restricted area, since measured dose rates required some caution. After these actions, demolition has been approved as there is no more significant contamination.

3. **Four phosphoric acid tanks** – containing about 10 000 m<sup>3</sup> of phosphogypsum - show significant dose rates and activity concentration; a new program for decommissioning has to be presented (see par. 4).

4. **Two pipes to transport slurry and water:** one used to transport slurry from the production plant to the phosphogypsum landfill, the other water from the landfill to the plant. They are 3 km long, with diameters of 40 and 32 cm and walls 4- and 3-cm thick, respectively. A preliminary survey, done with a TV camera to check the status of the two pipes, showed they have no scales and therefore probably do not need to be decontaminated.

5. **Phosphogypsum landfill:** between 1967 and 1981, phosphogypsum residues were directly discharged into the sea; between 1981 and 1992, residues were cumulated in the landfill (see fig.4). This landfill, composed of 4 basins (one is empty), is about 55 ha wide; the mean height of phosphogypsum residues is 14.5 m. In 2002 the Ministry of the Environment prescribed the building of an external wall, made with bentonite cement, 60 cm thick, 3,550 m long, at a distance of about 5 m from the heap of residues; the wall runs 3 m deep into the slab of underground clay. A draining trench between the wall and the heap was opened with a series of wells to collect rainfall percolate; an experimental station for chemical treatment of percolate was installed, in order to separate the dry component - to be deposited in the landfill - from purified water. The whole trench was lined with waterproof materials.

A survey is planned by APAT and ICRAM to check the status of the sea coast and sediment, sea water, seaweed, seafood, fish, sands within a distance of 200 m off the coast.



*FIG. 1. Site A, plant for phosphoric acid production*



*FIG. 2. Site A, a phosphorite store*

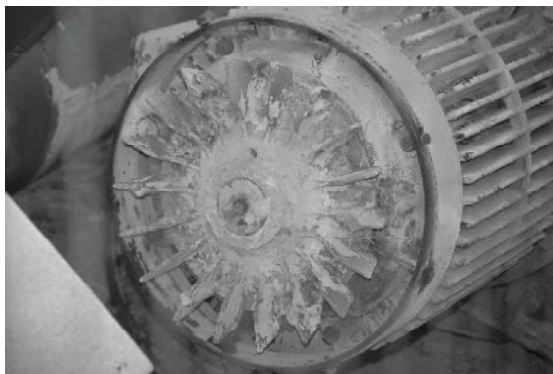

*FIG. 3. Site A, NORM scales in the plant.*



*FIG. 4. Site A, present state of the landfill.*

### 3.2.2. Site B

It has been very difficult to trace the origin and the development of the chemical installations in site B. This plant was surely working from the early '60s up to 1992. The plant and the surrounding area were split in several parts; the installations were either decommissioned or transformed for other purposes.

In 2002 APAT was involved in a survey on the deposit and the surrounding area to check for phosphorites. Some phosphorite was found on the ground; but the main problem was to assess the contamination due to chemical compounds and arsenic. For reasons unknown to the authors, a very long time was required to establish that the level of chemical contamination could be considered negligible.

In any case, the search for information and documents concerning the whole plant was unsuccessful, because fires and floods have deleted all records. However some information was gathered from some retired workers who remembered that:

1. phosphoric acid production started before 1960 and lasted up to 1982;
2. between 1982 and 1988 TPF (tripolyphosphate) was produced using phosphoric acid coming from Morocco;
3. since 1988 new productions have been carried out in completely new installations or in old installations after thorough renewal;
4. phosphogypsum residues were discharged directly into the sea, some 10 m off the coast;
5. no landfill for phosphogypsum residues was ever built.

In these days, a survey is about to be carried out on behalf of the plant management to check exposure rates and activity concentration in all the areas of the old plant. A preliminary survey was made by APAT. The area of plant was subdivided in twenty 50x50 m<sup>2</sup> meshes: the maximum dose rate in each mesh is reported in Table I. It shows residual NORM contamination on the ground.

TABLE I. MAXIMUM MEASURED DOSE RATE (nGy/h) IN THE AREA OF THE PLANT.

Mesh	M1	M2	M3	M4	M5	M6	M7	M8	M9	M10
nGy/h	392	392	252	352	529	bkg <sup>a</sup>	bkg <sup>a</sup>	bkg <sup>a</sup>	299	244
Mesh	M11	M12	M13	M14	M15	M16	M17	M18	M19	M20
nGy/h	392	244	191	260	bkg <sup>a</sup>	361	bkg <sup>a</sup>	224	291	321

<sup>a</sup> background value is about 180–190 nGy/h

APAT and ICRAM have scheduled a survey to check the status of the sea coast and sediment, sea water, seaweed, seafood, fish, sands within 200 m off the coast.

## 4. Radiation protection criteria and ensuing decisions

In the case of site A, the technical bodies with radiation protection tasks – APAT, ISPESL and ISS – were asked for advice about the existing landfill for phosphogypsum residues, the dismantling and remediation of the production plant, and the demolition of the three stores for the phosphorites. Most of the discussions the technical bodies engaged with the Ministry of Environment aimed at showing the differences between radioactive waste and by-products/residues coming from a work activity with NORM. Another notion that the technical bodies endeavoured to maintain was that a radiological remediation intervention must be a global plan, justified and optimised - taking into account the minimization of doses to the general population and workers -, and that this approach cannot be limited to some specific topics such as the technical aspects of decommissioning. As regards the landfill - which is close to agricultural settlements, just outside the very large industrial area that includes the production plant - the Ministry of Environment first decided, on the basis of the relevant cited law [11], to remediate it without removing residues. This requires that the activities of surveillance and maintenance of barriers be continued, as well as long-term restrictions on land-use (e.g. banning of house building or other burrowing activities that could affect the integrity of the closure cap). Countries facing similar situations have followed various approaches [15,16,17].

Starting from this previous decision, the technical institutes rejected the proposal of dismantling the plant with the complete decontamination of all the materials: indeed, the Ministry of Environment had proposed to clean all the remaining buildings and industrial structures completely in order to dispose them among general waste and to send the residues to a radioactive waste disposal. The technical institutes advised the Ministry that this solution was not optimised from the radiation protection point of view and would entail the unjustified exposure of workers. They are now waiting for a new demolition plan which minimizes manipulation. The best choice – in order to reduce the total volumes to be disposed of – would be to distinguish the materials that can be easily decontaminated from highly contaminated materials that, being of the same nature, can be added to the landfill. After some discussion, the proposal was accepted by the Minister of Environment.

## 5. Conclusions and future perspectives

The above considerations show that the most urgent problem to be solved at the national and international level is the harmonisation of legislation regarding conventional and NORM contaminations. This view is also supported by the European ALARA Network (see recommendation n. 2 of its 7<sup>th</sup> Workshop on Decommissioning and Site Remediation”, ref. 18). Indeed, about the integrated risk approach it was stated:

“An integrated (or ‘holistic’) approach to risk management in decommissioning and site remediation should be encouraged by **international bodies** such as IAEA, NEA and EC. This should be supported by **regulators** and implemented by **operators**, and should aim to include:

1. a simultaneous consideration of [*radiological and*] non-radiological hazards and risks, so as to provide the best overall protection of persons and the environment;
2. greater emphasis on life-cycle planning, where the issues of decommissioning and remediation are considered throughout”.

Other phosphoric acid production plants were operative in the past in Italy, and in the near future the three technical institutes (APAT, ISPESL and ISS) will be probably required by the Ministry of Environment to give their advice on radiological risks in those sites. The spontaneous creation of a working party among experts of the three institutes in order to issue joint official advices is a new and highly positive experience. The agreement on the approach to follow for site A was decisive: a dismantling design, optimised in terms of radiation protection, will be presented to the Ministry. Therefore, we hope this type of working method will continue and be officially recognised.

## ACKNOWLEDGEMENT

The authors are very grateful to Ms. Monica Brocco (Istituto Superiore di Sanità) for the linguistic revision of the manuscript.

## REFERENCES

- [1] EUROPEAN UNION. COUNCIL DIRECTIVE 96/29/Euratom of 13 May 1996 laying down basic safety standards for the protection of the health of the workers and the general public against the dangers arising from ionizing radiation. Official Journal of the European Communities L159, 29.6.96 (1996).
- [2] EUROPEAN COMMISSION, Reference levels for workplaces processing materials with enhanced levels of naturally occurring radionuclides Radiation Protection 95, Luxembourg: Office for Official Publications of the European Communities (1999).
- [3] EUROPEAN COMMISSION, Practical use of the concepts of clearance and exemption Part II Application of the concepts of exemption and clearance to natural radiation sources Radiation Protection 122, Luxembourg: Office for Official Publications of European Communities (2002).
- [4] EUROPEAN COMMISSION, Radiological considerations with regard to the remediation of areas affected by lasting radiation exposure as a result of a past or old practice or work activity Radiation Protection 124, Luxembourg: Office for Official Publications of the European Communities (2001).

- [5] DECRETO LEGISLATIVO 230/1995 del 17 marzo 1995 Attuazione delle direttive Euratom 80/836, 84/466, 89/618/, 90/641 e 92/3 in materia di radiazioni ionizzanti. Gazzetta Ufficiale della Repubblica Italiana - Supplemento ordinario n. 136 del 13-6-1995 (1995).
- [6] DECRETO LEGISLATIVO 241/2000 del 26 maggio 2000 Attuazione della direttiva 96/29/EURATOM in materia di protezione sanitaria della popolazione e dei lavoratori contro i rischi derivanti dalle radiazioni ionizzanti. Gazzetta Ufficiale della Repubblica Italiana - Supplemento ordinario della Gazzetta Ufficiale n. 203 del 31-8-2000 (2000).
- [7] DECRETO LEGISLATIVO 257/2001 del 9 maggio 2001 Disposizioni integrative e correttive del decreto legislativo 26 maggio 2000, n. 241, recante attuazione della direttiva 96/29/Euratom in materia di protezione sanitaria della popolazione e dei lavoratori contro i rischi derivanti dalle radiazioni ionizzanti. Gazzetta Ufficiale della Repubblica Italiana- Serie Generale n. 153 del 4-7-2001 (2001).
- [8] INTERNATIONAL COMMISSION ON RADIOLOGICAL PROTECTION, Protection of the public in situation of prolonged radiation exposure, ICRP Publication 82, Annals of ICRP **29/1-2** (2000).
- [9] INTERNATIONAL ATOMIC ENERGY AGENCY, Remediation of Areas Contaminated by Past Activities and Accidents, Safety Standards Series No. WS-R-3, IAEA,Vienna, (2003).
- [10] DECRETO LEGISLATIVO 152/2006 del 3 aprile 2006 Norme in materia Ambientale. Gazzetta Ufficiale della Repubblica Italiana n. 88 del 14-4-2006 - suppl. ord. n. 96 (2006).
- [11] DECRETO MINISTERIALE 471/1999 del 25 ottobre 1999 Regolamento recante criteri, procedure e modalità per la messa in sicurezza, la bonifica e il ripristino ambientale dei siti inquinati, ai sensi dell'articolo 17 del decreto legislativo 5 febbraio 1997, n. 22, e successive modificazioni e integrazioni. Gazzetta Ufficiale della Repubblica Italiana n. 293 del 15-12-1999 - suppl. ord. n. 218/L (1999).
- [12] INTERNATIONAL ATOMIC ENERGY AGENCY, Extent of Environmental Contamination by Naturally Occurring Radioactive Material (NORM) and Technological Options for Mitigation, Technical Reports Series No. 419, IAEA, Vienna (2003).
- [13] CARDINALE, A., et al., *Absorbed dose distribution in the Italian population due to the natural background radiation*. In: Proceedings of the second International Symposium on the Natural Radiation Environment (1972) 421. NRE-II – H. Beck (Ed.) USDOE – CONF – 720 805 – PL (NTIS), Springfield, VA (1972).
- [14] TROTTI, F., et al., *Towards the identification of work activities involving NORM in Italy*. Radioactivity in the Environment **7** (2005) 973.
- [15] VANMARCKE, H., et al., *The Radiological Impact of the Belgian Phosphate Industry*. In: Proceedings of full papers (CD Rom) of the Second European Congress on Radiation protection “Radiation protection: From knowledge to action”; 15-19 May 2006- Paris, France (2006).
- [16] MAS, J.L., et al., *An assay on the effect of preliminary restoration tasks applied to a large TENORM wastes disposal in the south-west of Spain*. Sci Total Environ. **364**(1-3) (2006) 55.
- [17] KOUKOULIOU, V., POTIRIADIS, C. *Radiation protection at workplaces with increased natural radiation exposure in Greece: recording, monitoring and protection measures*. In: Proceedings of full papers (CD Rom) of the European IRPA Congress 2002 “Towards harmonisation of radiation protection in Europe”, 8–11 October 2002, Florence, Italy.
- [18] EUROPEAN ALARA NETWORK. Summary and Recommendations of the 7th EAN Workshop on "Decommissioning and Site Remediation" Arnhem, The Netherlands (2003), <http://www.eu-alara.net/images/stories/Recommandations/ws7.pdf>.

# **Collective dose for the Netherlands and Belgium from a phosphorus plant: committed ingestion dose from farmland and influence of the weather**

**C.P. Tanzi**

National Institute for Public Health and the Environment (RIVM)  
Bilthoven, Netherlands

E-mail: [cristina.tanzi@rivm.nl](mailto:cristina.tanzi@rivm.nl)

**Abstract:** Elevated concentrations of naturally occurring radionuclides can originate from ore-processing industries. Emission from an elemental phosphorus plant is responsible for the highest emission to air of Po-210 and Pb-210 in the Netherlands. The plant operates under a permit, with the statutory assumption of an operational life of 25 years for the calculation of the dose. The collective dose due to the emissions from the plant is estimated combining the effective dose with the spatial distribution of the population in the Netherlands. For emission of Po-210 it is estimated in the order of 23 manSv. For Belgium the estimate is 7 manSv. The impact of the weather and of some common assumptions on the determination of the collective dose is illustrated.

## **1. Introduction**

Elevated concentrations of naturally occurring radionuclides can originate from ore-processing industries. In the Netherlands, a NORM industry is required to apply for an operating permit when the individual dose caused by its emission (to water and air) exceeds 10  $\mu$ Sv in any given year. An operational life of 25 years is assumed for the calculation of the dose. Here we review the impact of some assumptions on the assessment of collective dose.

## **2. Elemental phosphorus plant in the Netherlands**

The largest contribution to radiation dose levels due to emissions of radionuclides to air by all manufacturing industries in the Netherlands originates from an elemental phosphorus plant [1], see Fig. 1a, with emissions to air in the order of 500 GBq Po-210 and 50 GBq Pb-210 per year. The effective dose given by the emissions of this ore-processing industry (see Fig. 1b) is studied with an atmospheric dispersion model (Operational Atmospheric Transport Model for Priority Substances, OPS: [2]). The stack is 55 m high, and the heat content in the model is 1.5 MW, with all-year-round emission. The yearly inhalation dose has been estimated to be < 40  $\mu$ Sv for the nearest dwellings (approximately 4 km, on average downwind, from the stack) [3], showing that variations from year to year as large as 30% occur. This variation is determined exclusively by atmospheric conditions, and has to be taken into account for plants operating close to the permitted threshold.

For the average inhabitant of the Netherlands the largest impact on the dose derives from ingestion of food grown on contaminated farmland. The implementation of the IAEA guidelines [4] for the calculation of the ingestion dose to the situation in the Netherlands is here briefly illustrated. Also, the impact of different assumptions on the dose estimate is studied: yearly weather variations, plant operational life, accounting for contaminated crops, and changes in population. Changes in production and composition of the ores from year to year are not discussed here: a yearly emission of 500 GBq Po-210 is taken as representative for the phosphorus plant.



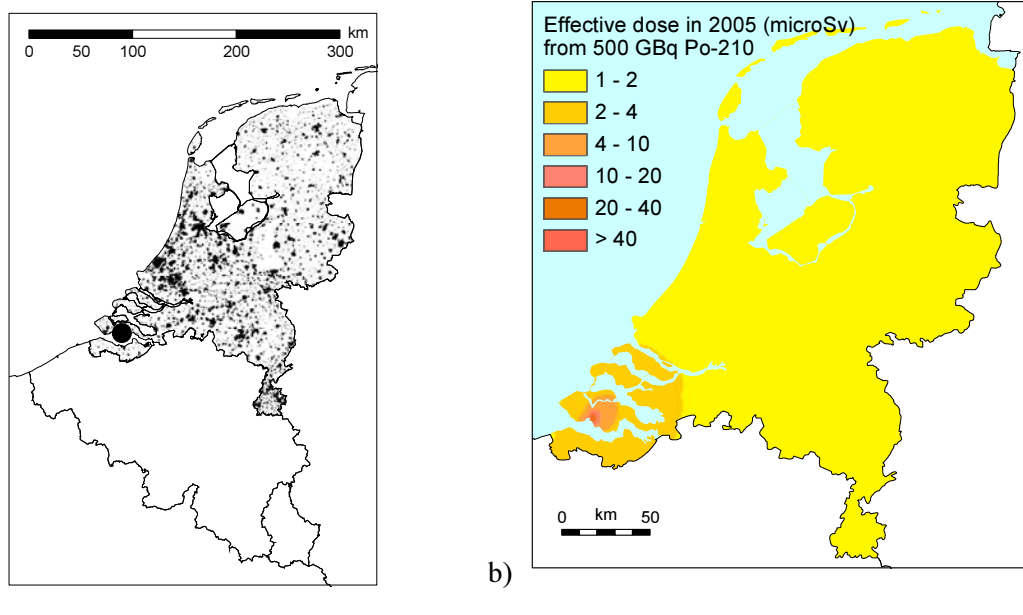

FIG. 1. a) The Netherlands and Belgium with the location of the elemental phosphorus plant (circle) and population distribution. The average wind direction is  $245^\circ$  (based on a thirty-year average). b) The effective dose calculated in the Netherlands for the emission (in 2005) of 500 GBq of Po-210 from the phosphorus plant, including the ingestion pathway (approximately  $1 \mu\text{Sv}$ ).

### 3. Radiological impact

The relevant pathways for exposure are inhalation and ingestion. For ingestion, both locally grown leafy vegetables and ingestion of food from a wide area of contaminated farmland contribute to the dose. Inhalation is dominant close to the source, while deposition of contaminants on farmland yields a contribution to the general public through ingestion which is estimated in the order of  $1 \mu\text{Sv}$ . The size distribution of the emitted particles has an impact on the calculation of the effective dose through the atmospheric dispersion. In case the particle size distribution is not accurately known, a distribution with 70% of the particles smaller than  $1 \mu\text{m}$  (“fine distribution”) is usually assumed. For the phosphorus plant in the Netherlands measurements in the past [5] have actually shown that most emitted particles have a size of  $1 \mu\text{m}$  or smaller: ground deposition (number of particles) deposited in a  $40 \text{ km}^2$  region around the plant is thereby only approximately  $1/3$  than would be the case for the “fine distribution” [3]. The average individual dose over the Netherlands, from ingestion of contaminated food, is 70% of the dose calculated for the “fine distribution” (see the summary in Table 3).

#### 3.1 Transfer coefficients

The radiological impact of regular emissions to air from industrial sources is calculated at RIVM using an atmospheric dispersion model, which determines both the air concentration and the deposition of the emitted radionuclides on farmland. For the transfer of the ground contamination to crops, a compartmental model is used [6], where the chosen parameters are predominantly based on IAEA parameters [4]. Conservative dose conversion coefficients are used.

Transfer coefficients are used to determine the contamination present in crops (vegetables and potatoes), cattle (cows and sheep only) and milk. Both the retention in the soil and the half-life of the nuclide play a role here. Dutch legislation assumes a continuous plant operational life of 25 years. As an illustration, the transfer coefficients for Pb-210, with a half-life of 22.3 years, would be halved if plant operations would last only one year. The phosphorus plant has been granted its first operating permit at the end of 1985 [7]: increasing the operational lifetime to 40 years yields an average increase



of the transfer coefficients by 17%. The activity of the emitted Pb-210 is however only about 10% of the Po-210 emitted by this plant (see Fig. 3 for the ingestion dose).

### 3.2 Nutritional habits

For the assessment of the ingested dose, the consumption of a few kg of leafy vegetables - produced locally - allows for a conservative estimate of the ingestion dose for members of the public living in the vicinity of the plant, where ground deposition can be significant. This is summed to the ingestion dose which is estimated on the basis of a standard food basket, representative of the nutritional habits of the general public. All consumed food which is likely to be contaminated is assumed to originate from the Netherlands. The yearly consumption assumed for the calculation of the individual dose is shown in Table 1. For comparison, the recommended values by the Netherlands Nutrition Centre are also given. The preparation of food reduces the presence of radionuclides before intake: the reduction factors are also given in Table 1.

TABLE 1: SOME ASSUMPTIONS FOR THE CALCULATION OF EFFECTIVE DOSE

The reduction factors (the preparation of food reduces the presence of radionuclides before intake), and the yearly consumption for calculation of the effective dose from ingestion. The 3.5 kg of leafy vegetables are assumed to originate locally: close to the source they can contribute significantly to the dose. For comparison the recommendations for consumption of adults from the Netherlands Nutrition Centre (<http://www.voedingscentrum.nl/>) in 2006 are also given (the weight of cheese is translated to the same amount of liters of milk).

	Tuberous plants	Cereals	Milk	Meat	Vegetables	Leafy vegetables (local)
Reduction factor	0.8	0.3	1	0.7	0.5	0.6
Yearly consumption (kg/y or L/y)	51	71	147	10 (cows, sheep)	38.5	3.5
Recommendations (kg/y or L/y)	68	70	172	40 (total)		73

### 3.3 Contaminated farmland

For the estimate of the ingestion dose from contaminated farmland, the average of the deposition over dry land is assumed to give a good estimate. This is true in case of a uniform distribution, but is not the case for the phosphorus plant. For example the collective dose from ingestion dose increases by about 10% if the averaging is done over smaller geographical units. These units (COROP, 40 in total) are in general smaller than provinces, are composed of towns and surrounding countryside, and they are defined in the Netherlands for the purpose of statistical analysis (see Table 2).

TABLE 2: INGESTION DOSE FROM CONTAMINATED FARMLAND

The effect of different assumptions on the contribution of the ingestion dose (actual land use, average over dry land and sum over 40 statistical regions, COROP) is shown. The collective dose from the inhalation path is approximately 6 manSv.

	Ingestion dose (manSv)
Average over dry land	12
40 smaller statistical regions (COROP)	13
Actual land use (1×1 km <sup>2</sup> grid)	17

Because the uptake of the radiological contaminants in the food chain depends both on the contaminant and on the type of food [4], modelling of actual land use provides a more accurate estimate than any simple average. Taking into account the actual use of farmland in the Netherlands (see Fig. 2), where pasture will transfer the contamination to both cattle and milk, yields an ingestion dose which is 30% higher than the one derived from a uniform distribution. The effective dose to the general public from farmland contaminated by the plant, assuming a representative emission for the phosphorus plant of 500 GBq of Po-210, is approximately 1  $\mu$ Sv for the assumed particle size distribution (most particles < 1  $\mu$ m), see Table 3.

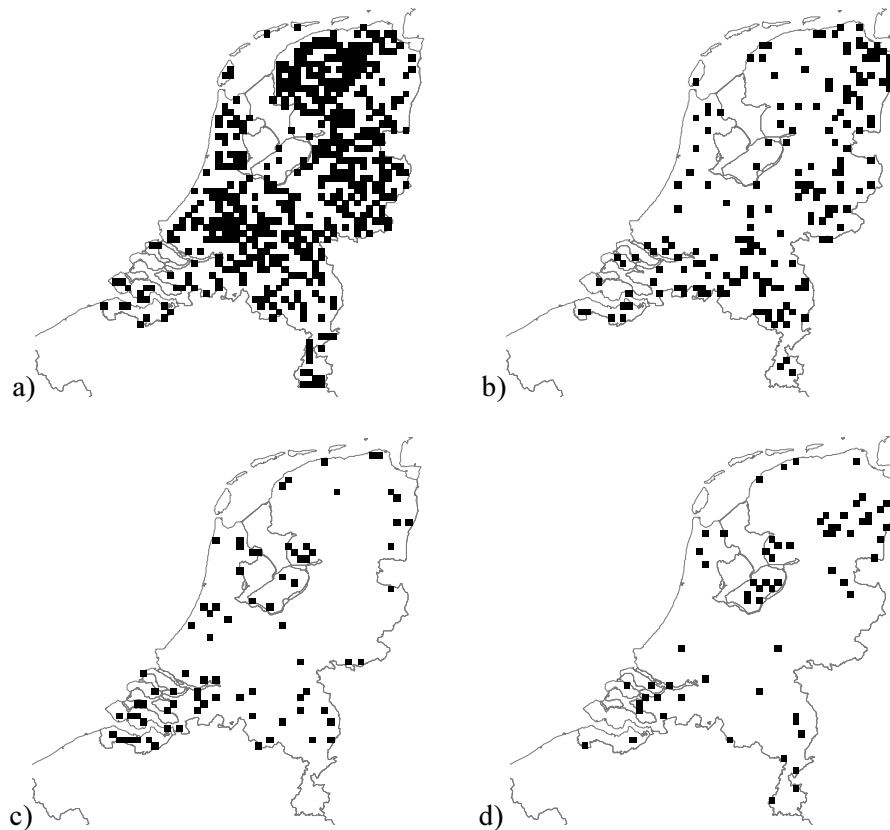

FIG. 2; Land use in the Netherlands for a) pasture b) grains c) green vegetables d) potatoes, here shown on a 5 x 5 km<sup>2</sup> grid (based on the 25 x 25 m<sup>2</sup> Dutch national land-cover LGN3 database, see e.g. [8]).

### 3.4 Effect of the weather on ground deposition and ingestion dose

The wind in the Netherlands blows predominantly from west-southwest: most of the particles emitted from the phosphorus plant are deposited over the Netherlands. The influence of the weather on the calculated yearly average ingestion dose can be as large as  $\pm 20\%$  (Fig. 3). Fig. 4 shows the wind rose for two extreme years, with 1996 showing varying wind directions (corresponding to the lowest calculated ingestion dose), and 1998 with wind predominantly from west-southwest direction.

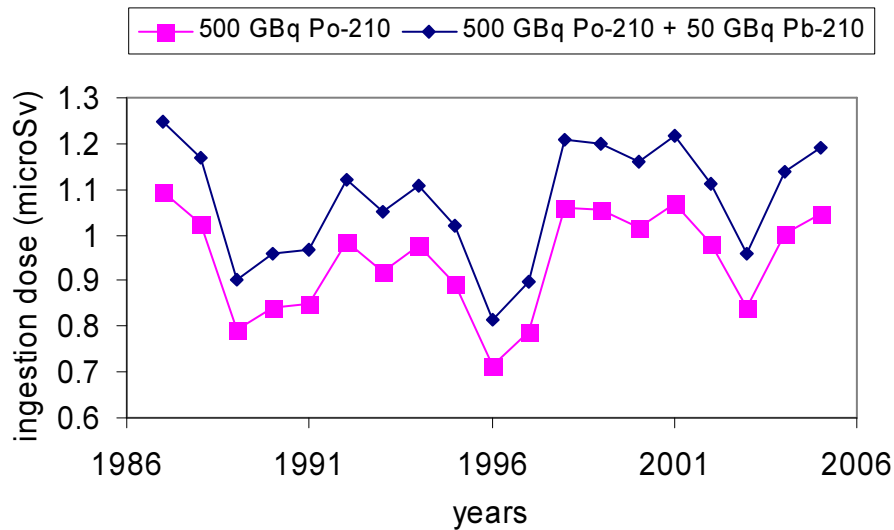

FIG. 3. Individual dose from ingestion, calculated from the actual land use on a  $1 \times 1 \text{ km}^2$  spatial grid for the Netherlands

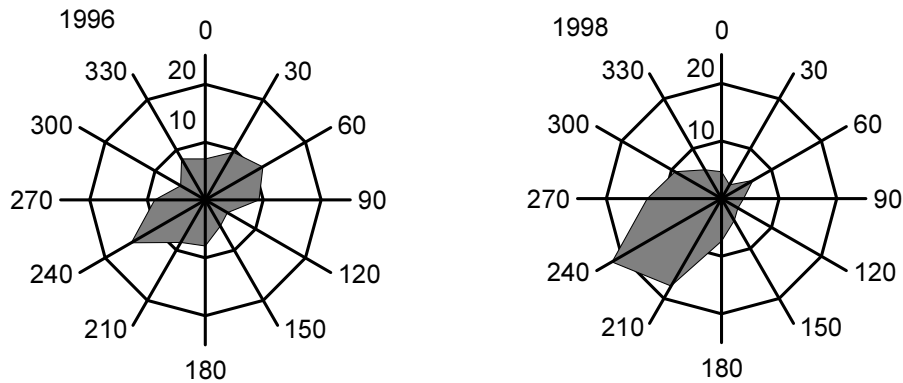

FIG. 4. Wind rose for 1996 and 1998 (percentage of days on the y-axis) from a weather station (Vlissingen: Flushing in English) at 7 km distance from the elemental phosphorus plant. Meteorological data from KNMI. The years 1996 and 1998 are extremes for the ingestion dose calculated in Fig.3.

#### 4. Collective dose

For the determination of the collective dose, the distribution of the effective dose of Fig. 1b is combined with the distribution of the population in the Netherlands (Fig. 1a), and scaled with the changes in total population (Fig. 5). The effect of changes in distribution of the population over the territory is insignificant when, as is the case here, the ingestion of contaminated crops dominates the effective dose. For the emission of 500 GBq Po-210 the collective dose for the Netherlands is 23 manSv for the year 2005, of which 17 manSv are from the ingestion of contaminated food calculated on the basis of the average food basket, 6 manSv from inhalation and  $< 1$  manSv from the yearly ingestion of 3.5 kg of locally grown leafy vegetables (Table 2).

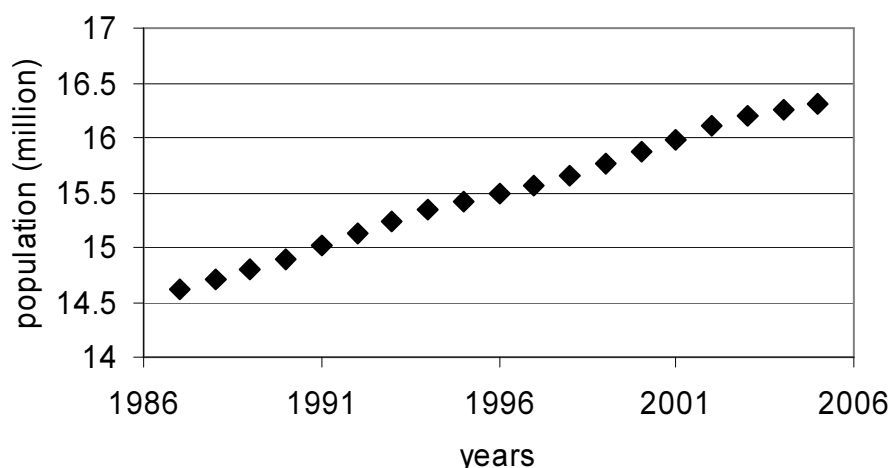

FIG.5. Population of the Netherlands at 1<sup>st</sup> of January of each year (data from [www.cbs.nl](http://www.cbs.nl)).

#### 4.1 Distribution of the population

Above, the assumption has been made of an all adult population. The ICRP [9] defines the collective dose as

$$S = \sum_i M_i \times N_i$$

where  $M_i$  is the mean effective dose of the population subgroup  $i$  and  $N_i$  is the number of individuals in subgroup  $i$ . Accurate statistics of age groups are available for the Netherlands, and the effect on the collective dose of accounting for these age groups has been estimated, as both the dose conversion coefficients and the pattern of consumption (derived from the advice of the Netherlands Nutrition Centre) vary with age. With the assumption of zero intake for infants younger than 1 year, the collective dose from the ingestion path thus calculated is 20% higher than is the case for the assumptions of an all-adult population (see Table 3).

#### 4.2 Radiological impact beyond the national borders

The effect of industrial emissions can extend beyond national borders. Article 14 of the Council Directive 96/29/EURATOM [10] stipulates that each Member State shall optimize the exposure of the population as a whole. In order to estimate the collective dose from the phosphorus plant for the neighbouring country of Belgium, some additional assumptions have to be made. Firstly, we rely on an extrapolation of actual data of weather stations in the Netherlands. Secondly, the contribution from contaminated farmland is based on an average over dry land, and on the same consumption patterns as in the Netherlands. Thirdly, the spatial distribution of the population is not taken into account: the inhalation dose is calculated on the country-average over the inhalation dose. For Belgium, the estimated collective dose is 7 man·Sv for a yearly emission of 500 GBq Po-210. This is about one third of the collective dose for the Netherlands.

### 5. Summary: uncertainty on the collective dose

In calculating the collective dose for an elemental phosphorus plant in the Netherlands, the effect of some assumptions has been shown. They are here summarized (Table 3) for an yearly emission to air of 500 GBq Po-210 at 55 m height, with 1.5 MW heat content and the size of most particles  $< 1 \mu\text{m}$ .

TABLE 3. SUMMARY (Effect of different assumptions on the individual and collective dose for the Netherlands for emission to air of 500 GBq of Po-210 at 55 m height and 1.5 MW heat content)

<i>Individual dose from ingestion in the Netherlands</i>		
Particle size distribution	custom (96% < 1 $\mu\text{m}$ ) 1 $\mu\text{Sv}$	fine (70% < 1 $\mu\text{m}$ ) 1.4 $\mu\text{Sv}$
Contaminated farmland	dry land, average 0.7 $\mu\text{Sv}$	land use, actual (1 $\times$ 1 km <sup>2</sup> grid) 1 $\mu\text{Sv}$
<i>Collective dose from ingestion in the Netherlands</i>		
Influence of weather	$\pm 20\%$	
Population distribution	+20%	

## 6. Conclusions

For an elemental phosphorus plant in the Netherlands, the largest contribution to the collective dose is from ingestion, after the assumption is made that all the food consumption originates from contaminated farmland in the Netherlands, and is of the order of 17 manSv (a yearly activity of 500 GBq of Po-210 has been considered).

For the Netherlands, the collective dose is 6 manSv from the inhalation path, and < 1 manSv from locally grown leafy vegetables. For ingestion of food from contaminated farmland, assuming all relevant food ingested originates in the Netherlands, the collective dose varies between 12 and 17 manSv according to the way that contaminated crops are evaluated (land average or actual land use).

Under some additional assumptions the collective dose for Belgium can be estimated at 7 manSv, which corresponds to 18 manSv for the Netherlands when calculated with similar assumptions.

The influence of the weather shows a 20% variation on the yearly ingestion dose, while assumptions on calculating the intake of contaminated produce from land (average over dry land, smaller geographical units or known land use) show a 30% variation. Assumptions made on the length of plant operation are only relevant for Pb-210, while the main emission from the plant is Po-210.

## ACKNOWLEDGEMENT

Dr H.Eleveld is gratefully acknowledged for useful suggestions and discussions.

## REFERENCES

- [1] Janssen, M.P.M., Blaauboer, R.O., and Pruppers, M.J.M., "Geographical Distribution of Radiation Risks in the Netherlands", *Health Physics* **74** 6 (1998) 677.
- [2] Van Jaarsveld, J.A., The Operational Priority Substance Model, RIVM Report 500045001, Bilthoven, The Netherlands, (2004).
- [3] Tanzi, C.P. and Eleveld, H., "Radiological Impact of Industrial Sources: Influence of Meteorological Conditions and Particle Size Distribution", 10th International Conference on Harmonisation within Atmospheric Dispersion Modelling for Regulatory Purposes, HARMO-10, Greece, 2005.
- [4] IAEA: "IAEA Technical Reports Series No. 364, Handbook of Parameter Values for the Prediction of Radionuclide Transfer in Temperate Environments", Vienna, (1994).
- [5] Timmermans, C.W.M., Erbink, J.J., Heling, R., "Dosis- en risicoberekening n.a.v. Po-210

- en Po-210 door Hoechst”, (in Dutch), KEMA Report 40031-NUC 93-5509 (1993).
- [6] Blaauboer, R.O., “Assessing the surroundings for effects of ionising radiation on the granting of permits, A. Emissions to air and water”, (in Dutch), RIVM report 610310006, Bilthoven (2002).
- [7] Erkens, W.H.H., “Electrothermal Phosphorus Production. Radioactivity in the Environment and Workplace” (Proc. of the International symposium on radiological problems with natural radioactivity in the Non-Nuclear Industry, Amsterdam, (September 8-10, 1997), KEMA (1997).
- [8] Van Oort, P.A.J., Bregt, A.K., de Bruin, S. , de Wit, A.J.W. , “Spatial variability in classification accuracy of agricultural crops in the Dutch national land-cover database”, *Int. J. Geographical Information Science*, **18** 6, 611–626, (2004).
- [9] ICRP 1991, “1990 Recommendations of the ICRP”, ICRP Publication 60 (Ann. ICRP **21**) (1-3), Pergamon, Oxford, 1991.
- [10] European Union, The Council, “Council Directive 96/29/EURATOM of 13 May 1996 laying down basic safety standards for protection of the health of workers and the general public against the dangers arising from ionising radiation”, *Official Journal of the European Communities* 39, L159, 29 June 1996.

# Dispersion of radionuclides through the Ebro River lower course ecosystem beyond the Flix reservoir

N. Casacuberta<sup>1</sup>, P. Masqué<sup>1</sup>, J. Garcia-Orellana<sup>1</sup>, J.M. Bruach-Menchén<sup>1</sup>,  
J.A. Sanchez-Cabeza<sup>2</sup>, A. Palanques<sup>3</sup>, J.O. Grimalt<sup>4</sup>

<sup>1</sup> Institut de Ciència i Tecnologia Ambientals  
Departament de Física. Universitat Autònoma de Barcelona.  
08193 Bellaterra. Spain.

<sup>2</sup> International Atomic Energy Agency,  
Marine Environment Laboratory,  
MC-98000, Monaco.

<sup>3</sup> Institut de Ciències del Mar (CSIC).  
Passeig Marítim de la Barceloneta, 37-49.  
08003 Barcelona, Spain

<sup>4</sup> Institute of Chemical and Environmental Research (CSIC).  
Jordi Girona, 18. 08034-Barcelona, Spain

## 1. Introduction

Approximately 600 000 t of industrial wastes were released into the Flix reservoir (Ebro River, Spain) for several decades containing elevated quantities of organic contaminants, heavy metals and radioisotopes. In particular, production of dicalcium phosphate (DCP) from Morocco's phosphate rock and further processed at the chemical industry located in Flix, ended up with the accumulation of wastes with high concentrations of <sup>238</sup>U and its daughter products (i.e. <sup>226</sup>Ra, <sup>210</sup>Po, <sup>210</sup>Pb, etc.) in the reservoir. Maximum specific activities of <sup>238</sup>U and its descendants were found to be in the order of 10<sup>3</sup> to 10<sup>4</sup> Bq/kg, and estimated inventories in the reservoir range from 10<sup>2</sup> to 10<sup>3</sup> GBq for each radionuclide. The radiological quantification of these muds led to the initiation of an exhaustive study of its potential mobility and, therefore, the effects through the entire ecosystem in the lower course of the Ebro River (along 98 km). Main efforts focus on the transport of the suite of radionuclides by water under different hydrodynamic conditions and their distribution in the Flix reservoir and the estuarine area. Agricultural soils and fruit and vegetable production are also being analysed, especially at paddy fields and rice seeds located down the river and spread out over the Ebro delta. In an ongoing research ecosystem organisms will be analysed. Macrophytes, phytoplankton, fishes (*Cyprinus carpio*, *Silurus glanis*), and others such as river bivalves (*Dreissena polymorpha*) and birds, shall let us gauge radionuclide dispersion through the trophic chain, aiming to estimate population exposure in further studies.

## 2. Description of the area of study

Flix (Figure 1) is a city of 4 000 inhabitants, located in the south of Catalonia, at 41° 13' 57" N and 0° 33' 4" E (North East Spain). The area of study is the lower part of Ebro river, starting at Riba-roja and Flix, which are both situated 98 km upstream, and ending in the Ebro river estuarine. A characteristic feature of the Ebro River is the Flix meander, from which the name of the city does come from (*flexu* in latin) and which permitted the building of a damn and a use of hydroelectric energy. The electrochemical factory is located on the right side of the reservoir, which started operating in 1897, has historically been the main contributor of <sup>238</sup>U isotopes and its descendants to the river through waste discharges.

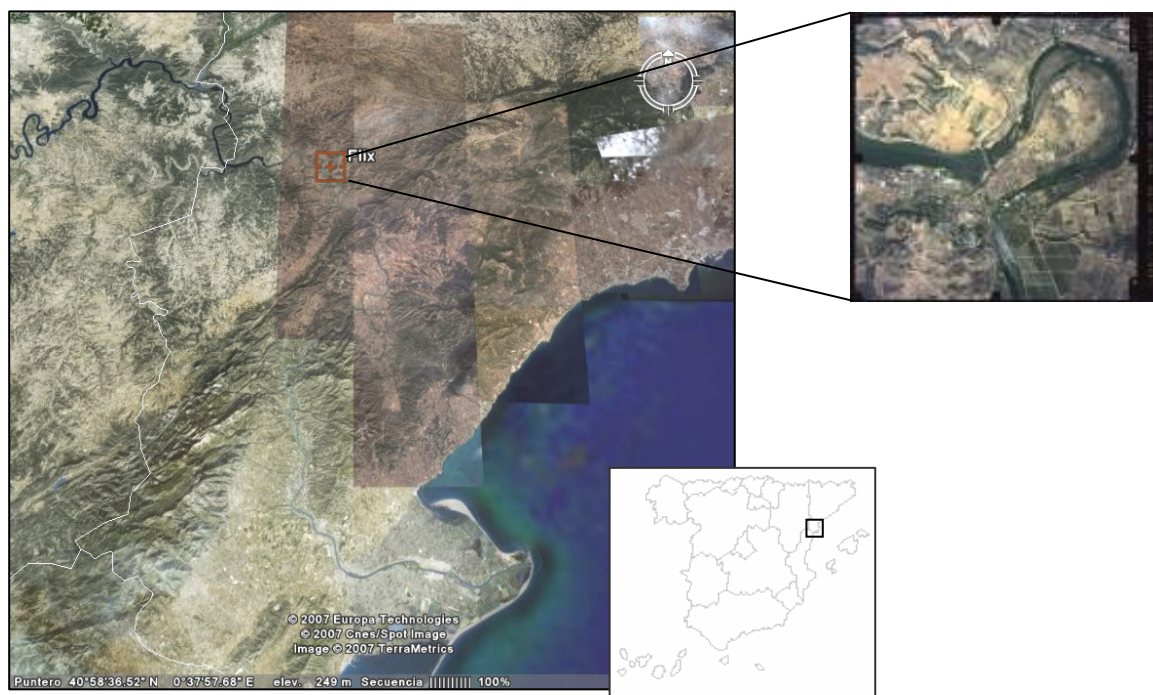

FIG. 1: Study area. Location of Flix and its meander is shown in the inset

### 3. Results

According to [1], the muds sitting in the Flix reservoir bed are characterised by maximum concentrations of the  $^{238}\text{U}$  series decay isotopes ranging, most of them from  $10^3$  to  $10^4$  Bq/kg [1]. In an attempt to investigate if remobilisation of this material is affecting the lower course of the Ebro river, suspended particulate matter (SPM) collected downstream from the Flix dam since 2002 has been analysed for  $^{210}\text{Po}$ . While increase in specific concentrations in SPM (from 30 to 90 Bq/kg) is observed in correspondence with increased flows (from 100 to up to  $1450 \text{ m}^3/\text{s}$ ), concentrations do not reach the maximum values measured in the potentially resuspended sediments. Concentrations of  $^{210}\text{Po}$  in SPM in the Ebro river estuary ranged from 17 to 45 Bq/kg, and increases seemed also to correspond to higher flows. On the other hand, specific activities for  $^{210}\text{Po}$  measured in SPM samples collected by using a sediment trap deployed for several weeks in the reservoir itself ranged from 700 to 1100 Bq/kg, suggesting that remobilisation of the dumped wastes do occur.

Overall, it is observed that specific activity for suspended matter varies along the river, being higher in the Flix meander and decreasing towards the estuary. Indeed, the water volume flow down the river causes the resuspension of marginal sediments which dilutes the potentially elevated signal from the reservoir.

The effects of the dumped muds in the Ebro ecosystem have been investigated by measuring the concentrations of natural (and artificial) radionuclides in agricultural soils spread out into the study area, taking into account the differences in watering systems. Data showed that both specific activities and inventories of  $^{232}\text{Th}$ ,  $^{226}\text{Ra}$ ,  $^{238}\text{U}$ ,  $^{40}\text{K}$ ,  $^{210}\text{Pb}$ ,  $^{137}\text{Cs}$  and  $^{60}\text{Co}$  in the 28 agricultural soils analysed fall in the range of natural soils in the Spanish Peninsula, as reported by [2]. Therefore, no significant impact has been observed in soils.

Drinking water has been also analysed in order to determine gross alpha and beta levels. Samples taken from the different populations of Riba-roja, Flix, Ascó, Garcia, Mora d'Ebre, Benifallet, Xerta, Tortosa, Amposta and Deltebre showed values ranging from  $0.11 \pm 0.01$  Bq/L and  $0.21 \pm 0.02$  Bq/L for gross alpha and from  $0.08 \pm 0.01$  Bq/L and  $0.25 \pm 0.02$  Bq/L for gross beta. Although highest



values correspond to Flix drinkable water, none of them exceeding the legal values (0.1 Bq/L for gross alpha and 1 Bq/L for gross beta) reported in [3].

#### 4. Further research

With the aim to obtain a fuller understanding of how the release of suspended matter enriched with  $^{238}\text{U}$  radionuclides and its decay chain daughters from the Flix reservoir might affect the ecosystem, further work is required. Carp (*Cyprinus carpio*), american cray fish (*Procambarus Clarkii*) and catfish (*Siluris glanis*) will be analysed as endogen organisms into the Ebro river. Mussel (*Mytilus galoprovincialiss*), noodle (*Donax trunculus*), winkle (*Bolinus brandaris*) and oyster (*Crasostrea gigas*) will indicate water pollution levels at the river's mouth. Finally, eggs of five endogen birds (*Egretta garzetta*, *Ardea purpurea*, *Nycticorax nycticorax*, *Sterna nilotica* and *Bubulcus ibis*) will be studied as population sentries.

#### REFERENCES

- [1] GRIMALT, J.O., SANCHEZ-CABEZA, J.A., PALANQUES, A. I CATALÁN, J. (2003). Estudi de la dinàmica dels compostos organoclorats persistents i altres contaminants en els sistemes aquàtics continentals. Informe final: Agència Catalana de l'Aigua i Comissió Interdepartamental de Recerca i Tecnologia.
- [2] UNSCEAR 2000. *Sources and Effects of Ionizing Radiation*. United Nations, New York.
- [3] Real Decreto 140/2003, de 7 de febrero, por el que se establecen los criterios sanitario de la calidad del agua de consume humano. BOE num 45, 7228-7245.



# Radium and uranium isotopes in Spanish phosphogypsum leachates

J.L. Aguado<sup>1</sup>, J.P. Bolívar<sup>1</sup>, R. García-Tenorio<sup>2</sup>

<sup>1</sup>Departamento de Física Aplicada  
Universidad de Huelva  
Facultad de Ciencias Experimentales, Campus El Carmen  
21007 Huelva  
Spain

<sup>2</sup>Departamento de Física Aplicada II  
Universidad de Sevilla  
ETSA, Avda Reina Mercedes 2  
41012 Sevilla  
Spain

**Abstract.** In order to study the potential release of radioactivity from Spanish phosphogypsum to the aquatic medium, we have designed laboratory forced leaching experiments to evaluate the degree of transference with time of <sup>226</sup>Ra and uranium isotopes from phosphogypsum to water. In these experiments, aliquots containing a 1:3 proportion of phosphogypsum in water were stirred under laboratory conditions during several time intervals. After stirring, leachates were filtered and their <sup>226</sup>Ra and <sup>234,238</sup>U concentrations were determined by alpha-particle spectrometry. Several and important conclusions can be remarked from the obtained results of this experimental work: i) the radium transfer from phosphogypsum to water is less than in the case of uranium, ii) the transference of radium is clearly reduced when leaching experiments are performed with fresh water instead of marine water, iii) the final <sup>226</sup>Ra concentration in leachates is indirectly related with the solubility of phosphogypsum in water, and, iv) the concentration of uranium isotopes in the leachates seems to be strongly related with the presence of traces of non-separated phosphoric acid in the phosphogypsum matrix.

## 1. Introduction

Phosphogypsum is a waste by-product derived from the wet process production of phosphoric acid from phosphate rocks. Spain produces around 3 million tons of phosphogypsum per year due to the activity of several phosphoric acid factories located in Huelva (SW of Spain). The radioactive content of the phosphate rock used by the factories and the chemical characteristics of the industrial process determine that these wastes have significant levels of natural radionuclides from the uranium series.

Phosphogypsum is separated from the phosphoric acid in the plants. After that it is transported to big piles located in a neighbouring marshland area where it is finally stored (gyp-stacks). The transport is carried out by pumping the wastes mixed with water in a proportion 1:3. These carrying waters, once were initially deposited on the stacks, are chemically treated and re-used by the factories (the so-called “closed water circuit”). On the other hand, it is important to mention that the tidal environment where the repositories are placed induces the periodic contact of the saline estuarine waters with the basement of the stacks. So, in order to study the potential release of natural radioactivity from phosphogypsum to the surrounding aquatic medium, we have designed laboratory forced leaching experiments to evaluate the degree of transference with time of <sup>226</sup>Ra and uranium isotopes from phosphogypsum to water.

## 2. Material and methods

Two different groups of phosphogypsum (PG) have been considered for the leaching experiments. First group was fresh PG, and it was collected from one of the factories before its transport to the piles. Taking in consideration the origin of the phosphate rock we have considered two fresh PG subgroups of samples: *M-fresh* PG (phosphate rock was imported from Morocco) and *S-fresh* PG (phosphate rock imported from Senegal).

The other set of phosphogypsum samples was collected directly from the gyp-stacks. In this case, we have collected two different samples: first one was collected from the surface of the piles (*surface-PG*), and the other was taken from the deeper layer of a 50-cm PG core (*deep-PG*).

Table I summarizes the Ra and U-isotopes activity concentrations found in these PG samples. Similar results have been widely reported by the literature (i.e. [1]). It is remarkable that  $^{226}\text{Ra}$  concentrations are several times higher than U-isotopes specific activities.  $^{238}\text{U}$  and  $^{234}\text{U}$  are almost in secular equilibrium and their concentrations are clearly lower in the *S-fresh* PG sample.

TABLE I. ACTIVITY CONCENTRATION ( $\text{Bq}\cdot\text{kg}^{-1}$ ) OF  $^{226}\text{Ra}$  AND U ISOTOPES IN PHOSPHOGYPSUM SAMPLES

Isotope	<i>M-fresh</i> PG	<i>S-fresh</i> PG	<i>Surface-PG</i>	<i>Deep-PG</i>
$^{238}\text{U}$	$233 \pm 17$	$19.0 \pm 2.1$	$175 \pm 12$	$131 \pm 8$
$^{234}\text{U}$	$241 \pm 17$	$23.3 \pm 1.9$	$185 \pm 12$	$131 \pm 8$
$^{226}\text{Ra}$	$818 \pm 40$	$682 \pm 45$	$825 \pm 34$	$664 \pm 26$

According to the usual mixtures used by the factories to transport PG to the piles, aliquots containing three grams of PG were mixed with 60 ml of filtered fresh or marine water ( $^{234,238}\text{U}$  and  $^{226}\text{Ra}$  concentrations in waters were negligible). Each 1:3 PG-water aliquot was stirred at 800 rpm under laboratory conditions of pressure and temperature for a certain interval of time (5, 10, 15..., 2880 min). After stirring time, the solution was immediately filtered through 0.8  $\mu\text{m}$  Millipore paper and pH of the liquid fraction was measured. Then, uranium and radium were radiochemically isolated from the leachates, electrodeposited onto stainless steel discs and their alpha emissions were counted by alpha-particle spectrometry using low background ion-implanted silicon detectors [2].

### 3. Results and discussion

Leachates from fresh PG showed lower levels of pH than leachates from PG collected from the piles. Particularly, acidity of *M-fresh* PG leachates was in the 2.5-3.0 pH range whereas *S-fresh* PG leachates showed greater values of pH (5.0-5.5). This result must be related to the fact that U-isotopes activity concentrations in *S-fresh* PG are lower than in *M-fresh* PG, because it has been reported that uranium is mainly associated to the acid during the phosphoric acid production in the factory ([1], [3]). On the other hand, leachates from *surface-PG* showed pH in the 6.5-7.5 range, whereas pHs of leachates from *deep-PG* were in the 5.5-6.5 range. Higher pHs in these samples than fresh PG leachates were expected because of the natural leaching of the piles by rain and tidal waters. Lower pHs in *deep-PG* leachates than *surface-PG* were expected too, because of the drainage of acidic waters used for PG transportation to the piles through the stacks.

The radioactive results of our work are analyzed in terms of an empirical *Activity Transfer Parameter (ATP)*. It gives us the fraction of the nuclide activity concentration of interest initially associated to the PG matrix that was found in the corresponding leachate.

Fig. 1 shows  $^{234,238}\text{U}$ -ATP behaviour in the case of *S-fresh* PG leachates. It is important to mention that each point of the graphic corresponds to a different aliquot that was stirred, filtered and measured. The results we have obtained are almost uniform and less than 8%. The corresponding uranium concentration results in leachates were in the 20-70  $\text{mBq}\cdot\text{l}^{-1}$  range.

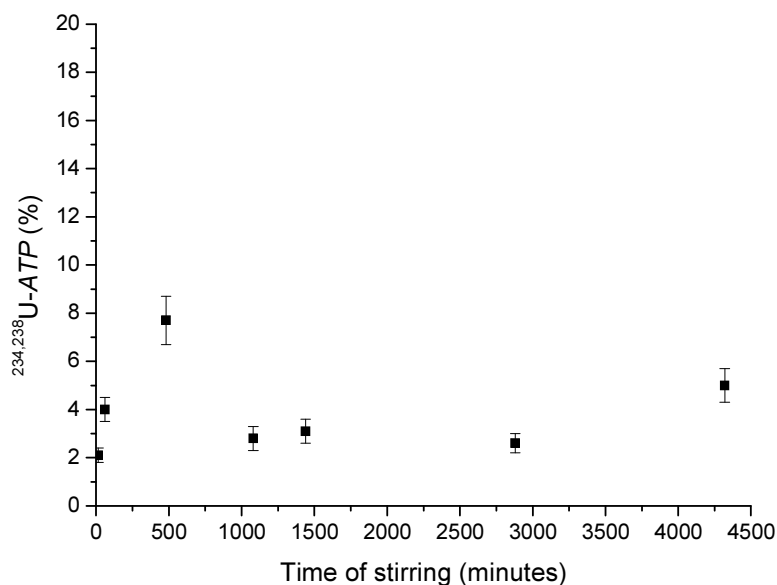

FIG. 1. Plot of  $^{238}\text{U}$  transferred from *S-fresh* PG to filtered fresh water versus time of stirring.

For *surface*-PG the uranium *ATP* parameter is reduced to 1%, but specific activities in leachates increased up to  $150 \text{ mBq}\cdot\text{l}^{-1}$ . Higher acidity was measured in *deep*-PG leachates, so  $^{234,238}\text{U-ATPs}$  were closed to 20% and activity concentrations reached the  $\text{Bq}\cdot\text{l}^{-1}$  order of magnitude. As it has been suggested by the literature [4], this enhancement in uranium mobility could be related to the drainage of acidic waters through the piles. Moreover, a slight but clear tendency of  $^{234,238}\text{U}$  concentration increasing with depth has been reported in several points of these Spanish PG stacks [5]. Then, it was expected that *ATP* for uranium reached its maximum value when pH of leachates were lower. In fact, results for *U-ATPs* in *M-fresh* leachates were in the 40%-50% range. In these conditions enhanced activity concentrations of U-isotopes in leachates were measured ( $10 \text{ Bq l}^{-1}$  in our experiments).

Keeping in mind the phosphoric acid and uranium association along the industrial process, it could be concluded that uranium transference from PG to water must be related to the presence of a soluble phase of phosphoric acid in the PG solid matrix. On the other hand, the low  $^{234,238}\text{U}$  specific activities found on *S-fresh* PG and *surface*-PG leachates ( $<0.1 \text{ Bq l}^{-1}$ ) are a consequence of previous industrial or environmental leaching processes and suggest that uranium must be mainly associated to refractory forms in these PG matrices. Previous work shows that the behaviour of uranium in PG are dominated by the role of phosphate and fluorine ions [4] and it has been recently reported that uranium (considered as trace element) was found predominantly ( $> 20\%$ ) in the non-water soluble phase after sequential extraction experiments [6], [7]. Finally, it is important to mention that secular equilibrium between  $^{238}\text{U}$  and  $^{234}\text{U}$  was found in all PG leachates and no significant differences were found among uranium results with fresh and marine waters.

For  $^{226}\text{Ra}$ , *ATP* values after leaching of fresh PG are clearly lower than uranium results. As it can be seen in Fig. 2, *ATP* in *M-fresh* PG leachates shows maximum values (almost 8%) with short times of stirring. After long periods of agitation the radium activity transferred to water seems to reach a steady value (1%). The corresponding  $^{226}\text{Ra}$  activity concentrations range in these acidic liquid fractions was  $0.5\text{-}3.0 \text{ Bq}\cdot\text{l}^{-1}$ . It is remarkable that these values are clearly higher than the Spanish gross-alpha specific activity regulatory limit for drinking waters.

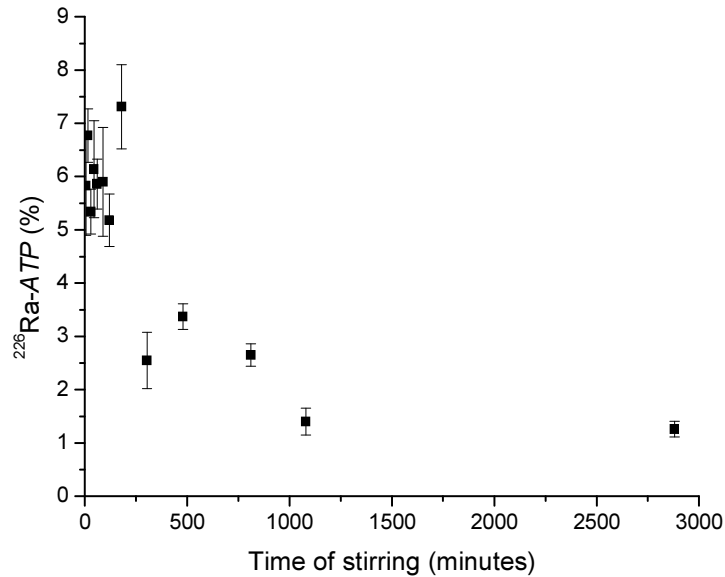

FIG. 2. Plot of  $^{226}\text{Ra}$  transferred from *M-fresh* PG to filtered marine water versus time of stirring.

After forced PG leaching with filtered fresh water, we have obtained a plot of ATP versus time of stirring very similar to Fig. 2 [5]. In fact, the activity concentration of  $^{226}\text{Ra}$  in the leachates for higher times of stirring were similar with fresh and marine water ( $0.5 \text{ Bq}\cdot\text{l}^{-1}$  and  $^{226}\text{Ra-ATP}$  close to 1%). Nevertheless, the  $^{226}\text{Ra-ATP}$  results for leaching experiments with fresh water for short times of stirring were clearly lower ( $\sim 5\%$ ) than ratios found with marine water. This difference must be related to the presence of ions in the marine water that could be initially adsorbed to the PG instead of radium [8]. It is important to point out that the solubility of fresh PG varies from  $7 \text{ mg}\cdot\text{ml}^{-1}$  (short times of stirring) to  $3 \text{ mg}\cdot\text{ml}^{-1}$  (long times of stirring), but the  $^{226}\text{Ra}$  concentration found in the leachates was disproportionate with the dissolution of the PG itself, in agreement with the results described in previous works [9].

Leachates of high pH (from *S-fresh*, *superficial* and *deep* PG samples) gave  $^{226}\text{Ra}$  ATPs quite uniform (almost 1.0 %), as well as leachates from *M-fresh* PG at high times of stirring. The corresponding radium activity concentration was in the  $0.1\text{-}0.5 \text{ Bq}\cdot\text{l}^{-1}$  range, with very slightly differences between marine and fresh water leachates. Then, our results show that a rapid leaching of fresh phosphogypsum with marine water releases the major fraction of  $^{226}\text{Ra}$  to the aqueous media (10%). On the contrary, while the history of efficient washes of PG increases (as part of the industrial process for the *S-fresh* PG due to its low content in uranium, or under the typical environmental conditions for the PG storage in piles)  $^{226}\text{Ra}$  tends to be associated with refractory forms of phosphogypsum. Operational speciation studies of  $^{226}\text{Ra}$  in PG have shown an association of radium with residual phases of the PG solid matrix as iron-oxide fraction for Brazilian PG [6] or barium sulphate phase for Florida PG [10].

#### 4. Conclusions

Enhanced levels of  $^{226}\text{Ra}$  and uranium isotopes have been found on forced leached solutions from different types of phosphogypsum in filtered fresh and marine waters. Results show a greater uranium transfer from fresh phosphogypsum to water than in the case of radium.  $^{226}\text{Ra}$  activity transference ratio is reduced when leaching experiments are performed with fresh water instead of marine water. Moreover, the final  $^{226}\text{Ra}$  concentration in leachates is directly related with the solubility of phosphogypsum in water, whereas the concentration of uranium isotopes in the leachates seems to be related with the presence of traces of non-separated phosphoric acid in the phosphogypsum matrix.

## REFERENCES

- [1] MAZZILLI, B. et al., “Radiochemical characterization of Brazilian phosphogypsum”, *Journal of Environmental Radioactivity* **49** (2000) 113.
- [2] AGUADO, J.L. et al., “A sequential extraction procedure to determine Ra and U isotopes by alpha-particle spectrometry in selective leachates”, *Czech Journal of Physics* **53** (2003) 533.
- [3] BOLÍVAR, J.P. et al., “Fluxes and distribution of natural radionuclides in the production and use of fertilizers”, *Applied Radiation Physics* **46** (1995) 717.
- [4] BURNETT, W.C., ELZERMAN, A.W., “Nuclide migration and the environmental radiochemistry of Florida phosphogypsum”, *Journal of Environmental Radioactivity* **54** (2001) 27.
- [5] AGUADO, J.L. et al., “<sup>226</sup>Ra determination in phosphogypsum by alpha-particle spectrometry”, *Czech Journal of Physics* **49 S1** (1999) 439.
- [6] SANTOS, A.J.G et al, “Partitioning of radionuclides and trace elements in phosphogypsum and its source materials based on sequential extraction methods”, *Journal of Environmental Radioactivity* **87** (2006) 52.
- [7] AL-MASRI, M.S. et al, “Distribution of some trace metals in Syrian phosphogypsum”, *Applied Geochemistry* **19** (2004) 747.
- [8] MOORE, W. S. “Radionuclides of the uranium and thorium decay series in the estuarine environment”. *Uranium-series disequilibrium: Applications to earth, marine and environmental sciences*, 2<sup>nd</sup> ed. Oxford (1992).
- [9] HARIDASAN, P.P. et al, “Dissolution characteristics of <sup>226</sup>Ra from phosphogypsum”, *Journal of Environmental Radioactivity*, **62** (2002) 287.
- [10] BURNETT, W. C. et al. “Fractionation of <sup>226</sup>Ra in Florida phosphogypsum”. *Environmental Radiochemical Analysis*, **234** (1999) 1.





# Conceptual use of NORM as primary shielding for radioactive wastes

A.S. Paschoa<sup>a</sup>, J.M. Godoy<sup>b</sup>, L.E.S.C. Matta<sup>b</sup>, H. Evangelista<sup>a</sup>

<sup>a</sup> Laboratório de Radioecologia e Mudanças Globais,  
Universidade do Estado do Rio de Janeiro (LARAMG/UERJ),  
Rio de Janeiro, RJ, Brazil

<sup>b</sup> Instituto de Radioproteção e Dosimetria,  
Comissão Nacional de Energia Nuclear (IRD/CNEN),  
Rio de Janeiro, RJ, Brazil

**Abstract.** An amount of naturally occurring radioactive material (NORM) wastes exceeding  $10^9$  metric tons is produced annually throughout the world. Each one of the continents produces a share of NORM wastes, but a large fraction with activity concentrations lower than the exempt concentration level (ECL). Once stabilized, NORM wastes can be containerized, and used as shielding NORM brick blocks (SNBB), if the activity concentration of each individual container is below the ECL. This paper will examine critically the conceptual use of SNBB as shielding elements for higher activity concentration wastes.

## 1. Introduction

It is well known today that more than  $10^9$  metric tons of naturally occurring radioactive material (NORM) wastes from various sources around the world is produced every year. Moreover, the amount of NORM wastes accumulated throughout the years is larger than  $10^{11}$  metric tons. Considering an average density of  $1.8 \text{ metric tons} \cdot \text{m}^{-3}$  for NORM produced in the oil industry alone there are estimates that just one well can generate about 2.3 metric tons of scales and sludge each year, after cleaning the tubes and equipment used in E&P processes, respectively [1]. In any case, there is a variety of sources of NORM wastes, some of them forgotten or unknown. Such sources of NORM wastes are usually called orphan sources, and may constitute a current problem [2]. There are cases in which the sources are not actually orphans, but the costs of treatment, stabilization and safe disposal are considered to be too high because the initial generators of NORM wastes are no longer in operation. By band large, even when this is not the case the industries or operators which generate NORM waste will accept responsibilities only after lengthy judicial battles. Meanwhile, the surrounding environment may become contaminated and populations exposed to ionizing radiation.

Countries with military industries which produce nuclear weapons and/or maintain nuclear military installations, or had them in the past tend to produce large amounts of NORM wastes. However, non-nuclear countries with only commercial nuclear programs for peaceful purposes produce also a sizable amount of NORM wastes. In addition, countries with extractive industries have produced along the time large quantities of low level radioactive wastes, most of them NORM wastes.

Nuclear accidents and spills from the uranium and thorium mining industries produce also NORM wastes. The volume and type of NORM wastes which can be produced in such cases will depend not only on the severity of the accident or spill, but also on the way they are dealt with.

This paper intends to propose a conceptual use of wastes transformed into Shielding NORM Brick Blocks (SNBB) with activity concentration below the exempt concentration level (ECL) for each relevant radionuclide. The SNBBs are intended to be used as primary shielding for higher activity wastes.

## 2. A brief overview of the monazite wastes extant in Brazil

In the years twenties of last century the “Societé Minière et Industrielle Franco-Bresilienne” built the first plant for physical separation of monazite in Brazil, in the small village of Guarapari, in the state of Espírito Santo, [3]. By 1936 the Brazilian monazite started being exported, but the records were not well kept [3]. In 1940 this company was transformed into the “Monazita e Ilmenita do Brasil

Ltda.,” which became MIBRA S.A. in 1946. Later on, the monazite plant in Guarapari became part of the “ORQUIMA Indústrias Químicas Reunidas do Brasil S.A.” [3-5]. Five years after the end of the World War II (WWII) the Brazilian government nationalized its monazite deposits, as India had done few years before [3]. In 1951, a new monazite separation plant SULBA – for “Sul da Bahia” – was built in Cumuruxatiba, as a joint venture with a German group [3]. Cumuruxatiba was known for its monazite deposits since the end the XIX century, when an English man, John Gordon, started transporting clandestinely tens of metric tons of monazite as ballast for ships from Brazil to Europe [3, 4]. At that time ORQUIMA started hydrometallurgical treatment of monazite in Guarapari and São Paulo.

In April 1960 the Brazilian government bought the control of most companies dealing with monazite in the country [6]. The first article of the decree that regulated the creation of the “Comissão Nacional de Energia Nuclear (CNEN)” established that prospecting and exploitation of nuclear mineral deposits located in the Brazilian territory become monopoly of the Union, as well as the production and commerce of nuclear materials. CNEN Resolution 1/63 defined monazite as a nuclear material. As a consequence, the only private enterprise dealing with monazite separation in the country, located in Guarapari, had to close its operations. This left behind a sizable amount of what could be called today NORM wastes. By 1967, the concept of nuclear material as applied to monazite had changed. Monazite was then considered legally a mineral which contained nuclear elements in coexistence thus subject to devolution of radioactive wastes. In practical terms this phraseology meant that the thorium and uranium contained in the radioactive wastes generated by the monazite industry could either be paid for or returned to CNEN [5, 6]. One of the unwanted consequences of this 1967 legal concept was to create an immense amount of radioactive wastes from the monazite cycle which could neither be treated as such, nor be used cost-efficiently to extract the uranium and thorium contained in them. Most of those wastes are in the form of cake II (Th and U oxides), better known as “torta II”, and mesothorium (Ba, Ra SO<sub>4</sub>). Torta II and mesothorium are not being generated any longer. Figure 1 is a simplified diagram of the magnetic separation and chemical processing of monazite concentrates that leads to torta II and mesothorium. The officially recorded total volume of NORM wastes produced by the monazite industry in Brazil until 2001 was about 10,000m<sup>3</sup>, distributed in three sites [7]. The amount and activity of the wastes stored in each site, as well as a brief description on how those wastes are stored are presented in Table I. The “Usina de Santo Amaro (USIN)” has been decommissioned and demolished since this information became available.

The NORM wastes accumulated in the Brazilian monazite operations are candidates to be transformed in SNBB, after being treated for decreasing activity concentration through mass increasing and stabilization. However, this transformation constitutes quite a challenge because the initial average activity concentration of the monazite wastes is very high (almost  $1.0 \times 10^4$  kBq/kg, and the total volume is large ( $\approx 10,000$  m<sup>3</sup>). As` a consequence, the additional mass to be added in the stabilization and activity dilution processes to these wastes may create extra difficulties.

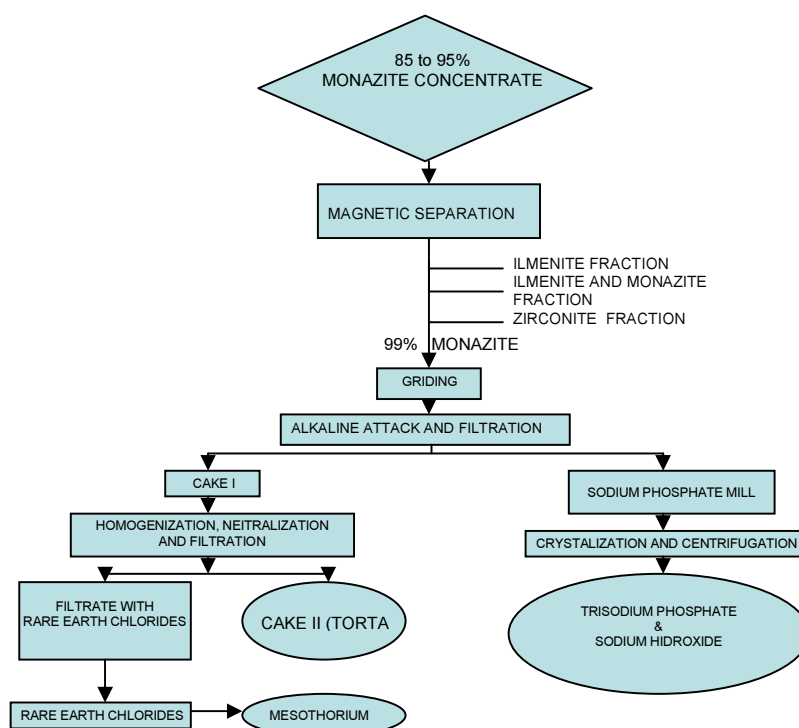

FIG. 1. Diagram of the industrial process used to separate magnetically and to attack chemically the monazite concentrates leading to cake II and mesothorium. Basic information adapted from Ref. [3].

An attempt has been made to extract most of the uranium from torta II, but the process, though successful in laboratory scale was not cost effective at commercial level. Contrariwise to the usual volume reducing methods used in waste treatment, like compacting the waste, the rationale behind the concept being suggested here is based in addition of mass to reduce the activity concentration. Compaction is still necessary to achieve the desired brick block format.

TABLE I. NORM WASTES ACCUMULATED BY THE MONAZITE INDUSTRY IN BRAZIL, WHICH WERE STORED IN THREE DISTINCT SITES (Data adapted from Ref. [7])

Site location	Volume (m <sup>3</sup> )	Average activity concentration* (kBq/kg)	Storage type	Aimed activity concentration (kBq/kg)
CIPC (MG)	7,250	9.6x10 <sup>3</sup>	Warehouse, silos, and trenches*	8.0
Botuxim (SP)	2,700	7,1x10 <sup>3</sup>	Concrete silos**	7.0
USIN (SP)	325	9.2x10 <sup>3</sup>	Warehouse	8.0

\* mesothorium plus torta II.

\*\* torta II only.

\*\*\* mesothorium, torta II plus trisodium phosphate.

### 3. Radioactive scales and sludge produced by the Brazilian oil industry

The E&P processes imply mobilization of naturally radionuclides extant in reservoirs. As one of the unwanted consequences, some of those radionuclides become scales incrustated inside tubes or deposited as sludge onto a variety of equipment. A wide range of concentrations of <sup>238</sup>U and <sup>232</sup>Th and their

respective progenies, mainly  $^{226}\text{Ra}$ ,  $^{222}\text{Rn}$  and  $^{210}\text{Pb}$  (from the  $^{238}\text{U}$  series), and  $^{228}\text{Ra}$  and  $^{228}\text{Th}$  (from the  $^{232}\text{Th}$  series) appear in the mentioned scales and sludge. The sludge contains also heavy metals, like mercury and other elements, and a variety of hydrocarbons sometimes in significant concentrations.

The radionuclides which appear in scales are mostly due to the co-precipitation of radium isotopes with barium sulfate added to the production water. However, the ultimate origin of the  $^{226}\text{Ra}$  and  $^{228}\text{Ra}$  is still object of debate. It has been suggested that there is a correlation between the age of petroleum and the  $^{238}\text{U}$  and  $^{232}\text{Th}$  concentrations found in the organic material from which the petroleum is originated [8]. There is not, however, any experimental data to confirm or not such hypothesis.

There are between  $3.0 \times 10^4$  to  $4.5 \times 10^4$  used and contaminated tubes stored in a site of the E&P region of the Brazilian oil industry in Macaé, depending on the source of information. A radiological assessment in the tubes established that the  $^{226}\text{Ra}$  activity concentrations measured in scales range from  $16 \pm 1$  to  $48 \pm 3$  kBq/kg, while for  $^{228}\text{Ra}$  activity concentrations the range was from  $4.0 \pm 0.4$  to  $42 \pm 3$  kBq/kg [9]. In sludge the  $^{226}\text{Ra}$  activity concentrations varies widely from  $0.15 \pm 0.01$  to  $340 \pm 12$  kBq/kg, and for  $^{228}\text{Ra}$  the range is from  $0.05 \pm 0.04$  to  $235 \pm 2$  kBq/kg [9].

Let be  $C_i = A_i(\text{Bq})/m(\text{kg})$  the activity concentration with  $i=1$  for  $^{226}\text{Ra}$  and  $i=2$  for  $^{228}\text{Ra}$  in incrustation (scale). If  $C_i > 10 \text{ kBq} \cdot \text{kg}^{-1}$ , the aim is to achieve a  $^{226}\text{Ra}$  or a  $^{228}\text{Ra}$  concentration  $C_i' < 10 \text{ kBq/kg}$ , after cleaning the tubes which had  $^{226}\text{Ra}$  or  $^{228}\text{Ra}$  contaminated scales. To do so a mass  $M$  of material (for treatment, dilution and stabilization) is added to the wastes produced after cleaning the tubes to obtain a concentration  $C_i' = A_i/(m+M)$ . Once the concentration  $C_i' < 10 \text{ kBq/kg}$  is chosen as a goal, the ratio  $M/m$  can be determined, that means the mass  $M$  to be added to the wastes becomes known. Here one must remember that the mass  $m$  of the resulting wastes is determined gravimetrically after the cleaning process has ended. To be specific, to determine the  $M/m$  ratio one can notice that:

$$\frac{C_i'}{C_i} = \frac{1}{1 + \frac{M}{m}} \quad (1)$$

which leads to  $\frac{M}{m} = \frac{C_i}{C_i'} - 1$  (2).

As an illustration, one can consider the specific case of  $C_i$  (kBq/kg) for  $^{226}\text{Ra}$  or  $^{228}\text{Ra}$  activity concentrations in scales in tubes stored in Macaé. Once the ratio  $C_i'/C_i$  is chosen for each specific case, the corresponding  $M/m$  ratio is obtained; thus for  $C_i'/C_i = 1/4$ ,  $M/m = 3$ .

The frequency distributions of the  $^{226}\text{Ra}$  activity concentrations in scales are shown in Figs. 2a and 2b, based on data presented in Ref. [9]. Similarly, the frequency distributions of the  $^{228}\text{Ra}$  activity concentration in scales are shown in Figs. 3a and 3b, based on data presented in Ref. [9].

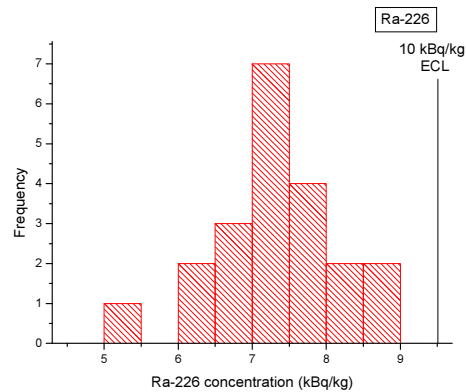
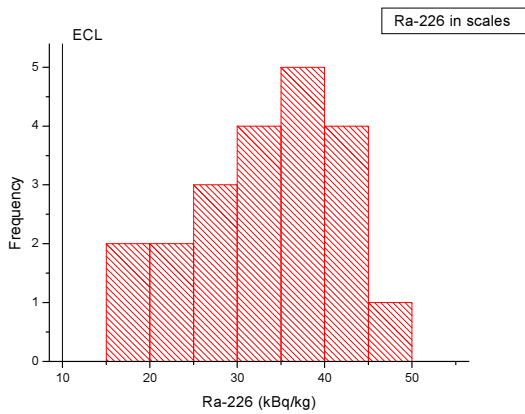

(a)

(b)

FIG. 2. Frequency distribution of  $^{226}\text{Ra}$  activity concentrations in scales (a) as it stands now; and (b) as it is intended to become after being treated, diluted and stabilized to be transformed into SNBB

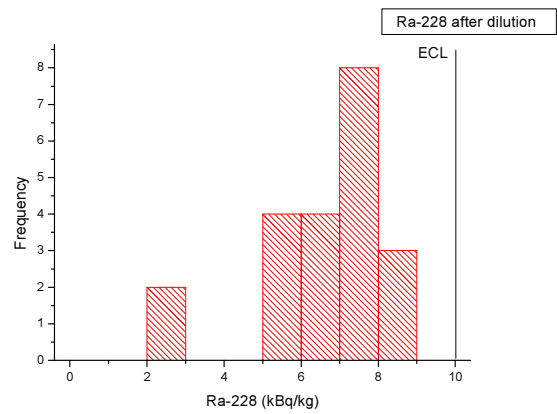
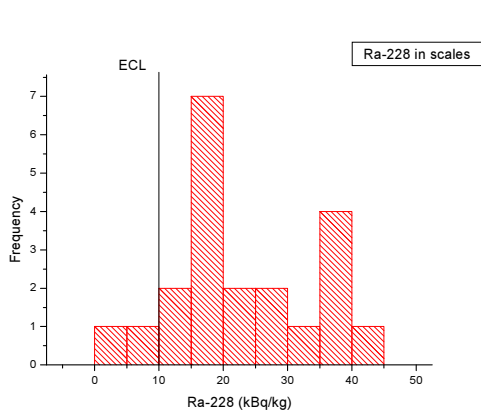

(a)

(b)

FIG. 3. Frequency distribution of  $^{228}\text{Ra}$  activity concentrations in scales (a) as it stands now; and (b) as it is intended to become after being treated, diluted, and stabilized to be transformed into SNBB.

In 1984 some countries of the European Community (EU) established the first derived limits for NORM/TENORM (Technologically Enhanced NORM) for a variety of materials in terms of activity concentrations (i.e., Bq per volume, area or mass). Those derived limits varied from country to country, but there were an evolution along the time. In 1996, the EU approved a specific legislation for NORM/TENORM in several materials and industries, including the oil and gas industry [10].

Table II summarizes the derived limits adopted by the EU legislation in 1996. The derived limit of 10kBq/kg was adopted for  $^{226}\text{Ra}$  plus progeny and  $^{228}\text{Ra}$  plus  $^{228}\text{Ac}$ . It has been suggested that 10kBq/kg could be adopted in Brazil as Exempt Concentration Levels (ECL) for both  $^{226}\text{Ra}$  plus progeny and  $^{228}\text{Ra}$  plus  $^{228}\text{Ac}$  as a starting point to regulate NORM [11].

TABLE II. DERIVED LIMITS (DL) ADOPTED BY EU MEMBER STATES DEALING WITH NATURAL RADIOACTIVITY FROM OIL AND GAS PRODUCTION (Information adapted from Ref. [10])

Radionuclide	DL adopted by the EU 1996 Directive (kBq/kg)
<sup>226</sup> Ra plus progeny until the end of the chain	10
<sup>210</sup> Pb plus <sup>210</sup> Bi and <sup>210</sup> Po	10
<sup>228</sup> Ra plus <sup>228</sup> Ac	10
<sup>232</sup> Th plus progeny until the end of the chain	1

Taking into account the derived limits adopted by the EU shown in Table II, the mass  $M$  to be added to obtain the <sup>226</sup>Ra or <sup>228</sup>Ra concentrations  $C' < 10\text{kBq/kg}$  after treatment, stabilization and dilution of NORM wastes will depend on the initial concentration of each one of these radionuclides. Thus, for example, if the initial concentration of <sup>226</sup>Ra or <sup>228</sup>Ra is  $C_i = 40.4\text{kBq/kg}$ , and after treating, stabilizing and diluting the wastes the concentration aimed to be achieved is  $C'_i = 8.1\text{kBq/kg}$  (i.e.,  $C'_i/C_i = 1/5$ ), the mass to be added needs to be  $M_i = 4m_i$ . In the case of the transformation referred to in Figure 2, the total mass to be added is  $\Sigma M_i = 74m$ , and for the case of Figure 3, the total mass is  $50m$ .

Solid radioactive wastes usually undergo compaction and are treated with cement, bitumen and stabilizing agents to become a monolithic bloc. Liquid radioactive wastes are heated to evaporate the aqueous or solvent phase becoming more concentrated. NORM waste resulting from water jetting used to clean tubes with radioactive scales became a thick mixture, which is neither solid nor liquid. This kind of mixture can be treated by means of special cement with density higher than the mixture itself, then stabilized with bitumen (itself usually containing slight amounts of NORM) plus a polymerized material. Here it is worth mentioning that the liquid phase of the NORM waste can be used to hydrate the cement used.

The radium isotopes found in scales are usually due to co-precipitation with barium sulfate added to the production water. It is well known that radium sulfate is one of the most insoluble compounds of the element radium found in nature, with solubility of  $2 \times 10^{-4}\text{g/mm}$ . Because radium is the main element to be immobilized in NORM wastes, the use ion exchange resins become a good candidate for the immobilization of this element [12]. Moreover, geothermal residues have already been stabilized by encapsulation in polymer concrete [13].

Once stabilized NORM wastes can be pressed to take the format of a brick block with adequate dimensions to achieve a concentration below the adopted ECL. High  $Z$  stable elements could be added to the SNBB to increase the shielding capacity.

The cost-effectiveness of the conceptual use of NORM as shielding material for higher activity wastes will need to be worked out as soon as the specifics of the project will be established.

#### 4. Conclusions

1. A conceptual use of NORM as shielding material for higher activity wastes was presented and discussed critically from the technical viewpoint.
2. It is not clear that the concept can be used to take care of NORM wastes originated from the monazite industry in Brazil.
3. It was shown that the concept will be helpful to take care of the NORM wastes (such as radioactive scales and sludge) which will result from cleaning tubes and equipment used in the E&P of the oil industry in Brazil.

## REFERENCES

- [1] PASCHOA, A. S., Radiological Impact due to Oil and Gas Extraction, Business Briefing: Exploration and Production (2003), Reference Section pp. 1-4. Also available from [www.touchoilandgas.com/](http://www.touchoilandgas.com/)
- [2] PASCHOA, A. S., Are the orphan sources a current problem?, 11<sup>th</sup> International Congress of the International Radiation Protection Association (IRPA11), Plenary Session – 4 – Natural Radioactivity Issues in Radiation Protection, Madrid, Spain - May 23-28, 2004. <http://www.irpa11.com/>
- [3] PASCHOA, A. S., The Monazite cycle in Brazil: past, present and future, Actinide Processing Methods and Materials (Proc. Int'l. Symp., 1994) (MISHRA, B, AVERILL, W. A., Eds.) The Minerals, Metals & Materials Society, Pennsylvania (1994) 323-338.
- [4] LEONARDOS, O.H., Monazita no Brasil, Separata de Engenharia, Mineração e Metalurgia, **22** (1955) pp.1-4. In Portuguese.
- [5] MACIEL, A. C., CRUZ, P. R., Perfil analítico do tório e terras raras. Report to the Ministério de Minas e Energia. Departamento Nacional de Produção Mineral. Rio de Janeiro (1973). In Portuguese.
- [6] PASCHOA, A. S., Overview of environmental and waste management aspects of the monazite cycle, Radiation Protection in Australia, **11** (1993) pp.170-173.
- [7] COMISSÃO NACIONAL DE ENERGIA NUCLEAR (CNEN), MINISTÉRIO DE CIÊNCIA E TECNOLOGIA (MCT), Rejeitos Radioativos, NOV/2001. In Portuguese.
- [8] PASCHOA, A. S., Naturally occurring radioactive materials (NORM) and petroleum origin, Applied Radiation and Isotopes, **48**, 1391-1396 (1997).
- [9] MATTA, L. E. S. C., Aspectos Radiológicos Ocupacionais Relacionados à Presença de Radionuclídeos Naturais em Estações de Extração e Produção de Petróleo. Doctoral Thesis, Universidade Federal do Rio de Janeiro (UFRJ), Rio de Janeiro (2001). In Portuguese.
- [10] EUROPEAN COMMISSION, Current practice of dealing with natural radioactivity from oil and gas production in EU Member States, Report EUR 17621, Brussels (1997).
- [11] PASCHOA, A. S., “NORM and the Brazilian non-nuclear industries”, Radiological Problems with Natural Radioactivity in the Non-Nuclear Industry (Proc. Int'l. Symp. Amsterdam) paper 2.5 (1997).
- [12] PARAMOROVA, V. I., Theoretical foundations and application of ion exchange in radiochemistry, Atomic Energy – Translated from Atommaya Énergya **33**, 728-731 (1972).
- [13] WEBSTER, R. P., KUKACKA, L. E., Stabilization of geothermal residues by encapsulation in polymer concrete and Portland cement mortar composites, Brookhaven National Laboratory (BNL 40640) Nov. 1987. Prepared for presentation at the Technical Symposium on Polymer Concrete Institute, Orlando, Florida, March 20-25, 1988. Available from <http://www.osti.gov/energycitations/servlets/purl/5490429-x6T15J/>.





## Identification of NORM industries at the entrance of a steel factory

L. Quindós, C. Sainz, I. Fuente, L. Quindos-Lopez , J. Arteche

Universidad de Cantabria, Facultad de Medicina, C/Cardenal Herrera Oria s/n 39011, Santander, Cantabria, España

Introduction of uncontrolled radioactively contaminated material in the recycling stream, with either natural radionuclides or man-made radionuclides could pose a safety and health hazard for workers due to external or internal exposure to ionising radiation. External exposure can occur due to physical contact or close proximity to the radioactively contaminated material. Internal exposure can occur due to direct contact with or processing of the material that can cause a worker to inhale, ingest or absorb the radioactive material. Introduction of such material may also generate significant business disruption and financial loss for both industries due to detection and rejection of the material or handling and processing of undetected material which could contaminate equipment, grounds, products and by-products. Results of the measurements developed during the last five years at the entrance of a steel factory are shown in this work with special emphasize in the NORM materials.

As a consequence of globalization, the interchange and use of prime materials and products with high levels of naturally radioactive material (NORM) which are employed in different productive activities have been increased during the last few years.

Together with the increase of detection of radioactive sources at the entrance of steel factories (Fig. 1), the greatest proportion of these alarms was caused by NORM materials (Fig. 2). So, this preventive measurement taken at the steel industry has resulted in a useful diagnosis tool for detecting potential radiological problems in refractory material management, for example.

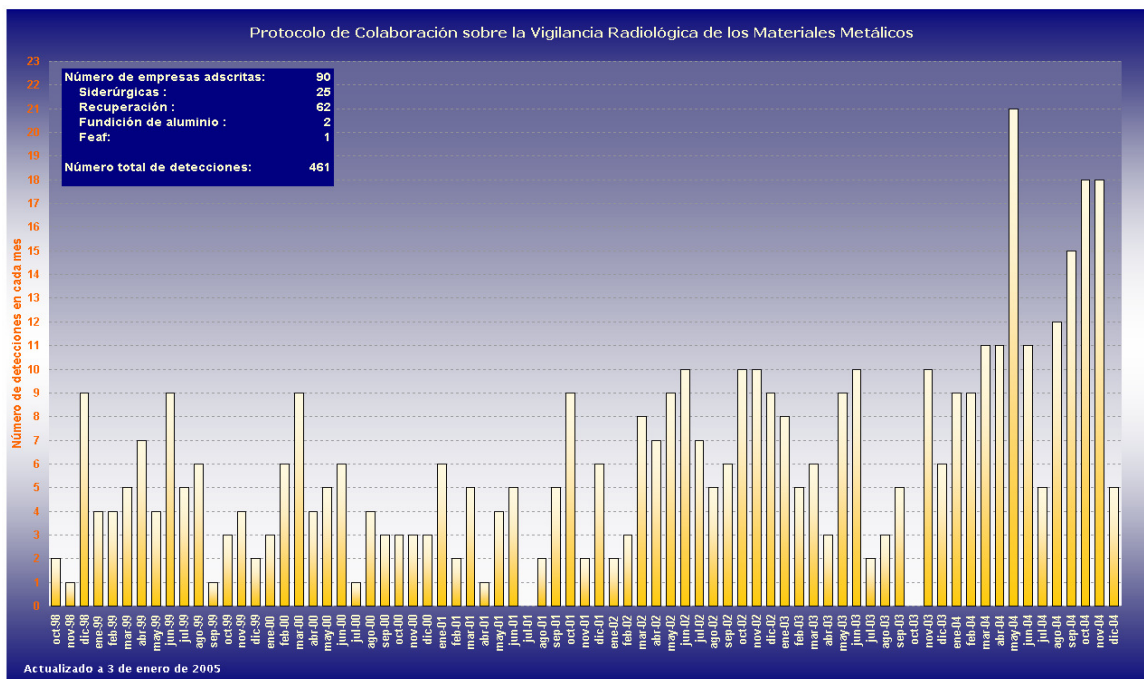
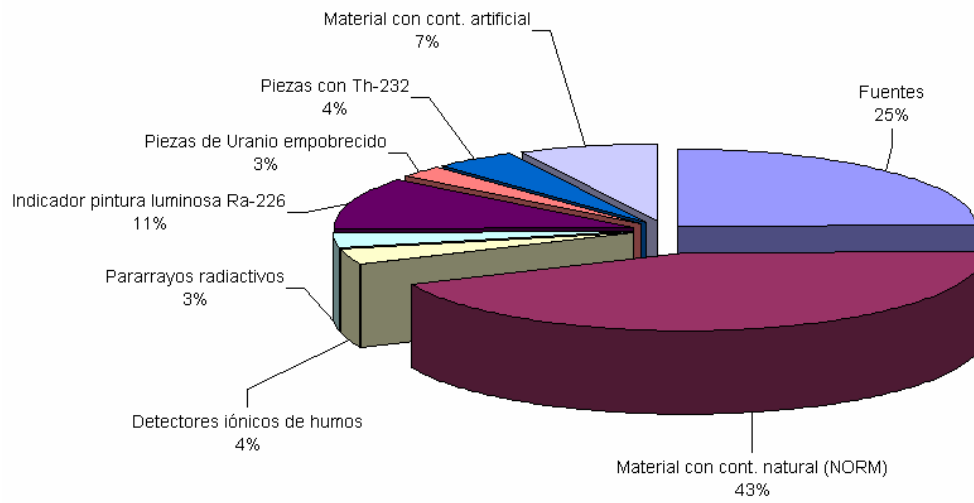

FIG. 1. Number of detections of radioactive material per month in different Spanish steel industries (Source: Spanish Nuclear Safety Council, CSN)

## Material radiactivo en detecciones



*FIG. 2. Relative contribution of different sources of radiation to the detections of radioactive materials at the entrance of steel factories (Source: Spanish Nuclear Safety Council, CSN)*

# **NORM radiological control of wastes produced by a steel recycling factory in the south of Spain**

**J. Mantero<sup>a</sup>, G. Manjón<sup>a</sup>, R. García-Tenorio<sup>a</sup>, S. Hurtado<sup>b</sup>, M. Villa<sup>b</sup>, M.C. Jiménez<sup>a</sup>, I. Vioque<sup>a</sup>, J. Díaz<sup>c</sup>**

<sup>a</sup> Departamento de Física Aplicada II, ETS Arquitectura  
Universidad de Sevilla  
Sevilla, Spain

<sup>b</sup> Servicio de Radioisótopos. CITIUS  
Universidad de Sevilla  
Sevilla, Spain

<sup>c</sup> Departamento de Física Atómica, Molecular y Nuclear, Facultad de Física  
Universidad de Sevilla  
Sevilla, Spain

**Abstract.** Radioactive scrap metal management becomes of a great importance from a radiological point of view in order to evaluate health risks, environmental impact and socioeconomic issues. Iron and steel scrap comprises a major portion of the potential scrap volume. As petroleum, gas and phosphate rock extraction and processing equipment is a current source of radioactive scrap metal, the problem can be considered inside the NORM studies. The Spanish Nuclear Security Council has reported 289 cases during the last years of radioactive presence in scrap metal in the iron and steel industry in Spain, 44 % were considered NORM. Social organizations, related to Spanish Metal Industry, consider the presence of radioactivity in iron and steel scrap an event not originated by such industry and, thereby, they are demanding rapid and clear regulations by Authorities. This contribution presents data on the determination of activity concentration of natural radionuclides in wastes of a recycling steel factory located in the vicinity of Seville, South of Spain. Samples were collected in air opened piles placed in the factory and, independently, taken in successive sampling campaigns in a rubbish dump area located 65 km far from the factory. Drain water and sludge samples, both deposited at the low tide of the wastes piles were also collected in order to observe a possible environmental impact around the rubbish dump.

## **1. Introduction**

A steel recycling factory, “Siderúrgica Sevillana” Co., is located in the vicinity of the town of Seville. Thousands tons per year of iron and steel scraps arrive to Siderúrgica Sevillana’s factory. The most important input path of material, 60% of the total volume, uses the river port of Seville. The origin of this material is from abroad. The rest, about a 40%, is coming from Spanish industries and is usually carried by road. Both ways comprise 700,000 Ton per year of scrap material that is transformed in this factory. Some accidents in the past, such as occurred in Acerinox Co. (Cádiz, South of Spain), and related with uncontrolled radioactive sources (<sup>137</sup>Cs), have favoured that a radiological control on each scrap received by this factory is applied.

Actually, several detectors of gamma-rays are operating in this factory in order to avoid any kind of accidents. Indeed, an emergency event occurred in 2001 when a <sup>137</sup>Cs source was melt in the factory’s furnace. The presence of the gamma source was detected and the recycling processes were immediately halted. In addition to the cleaning tasks carried out inside the factory by Enresa (Spanish Radioactive Waste Management Company), some environmental controls were made by our laboratory [1, 2] in the frame of the Spanish Environmental Radiological Control Net (so-called



FIG. 1 Radioactivity detectors are distributed in some places of the recycling steel factory.

REVIRA-REM in Spanish), conducted by the Spanish Nuclear Safety Council (Consejo de Seguridad Nuclear in Spanish).

With a steel production yield of 90%, the recycling steel factory generates 70,000 annual tons of wastes with a density of  $2.8 \text{ Ton m}^{-3}$  what implies a volume of  $25,000 \text{ m}^3 \text{ y}^{-1}$  of slag. Although wastes from a metal recycling factory become useful for several human activities[3, 4], a major part of the slag have to be stored at the closest and most suitable place as possible. For these reasons, the area called “La Arenilla”, located in the vicinity of the town of Puebla de Cazalla, which is 65 km far from the factory, was chosen, some years ago, to store these wastes. As far as we know, this rubbish dump will be used for 12 years.

## 2. Materials and methods

### 2.1. Sample collection and preparation

Both the recycling steel factory and the rubbish dump have been sampled to check the presence of radioactive isotopes. In the factory, we have sampled the area were the wastes, initially to  $600^\circ\text{C}$ , are piled up in order to be cooled until their temperature decreases enough to be moved to “La Arenilla” rubbish dump. These samples were sifted and packed using Petri box geometry. The boxes were sealed with silicone gel to avoid losses as radon emanations from the sample.

A second group of samples were collected in three sampling campaigns in November 2005, March 2006 and January 2007, respectively, in the “La Arenilla” rubbish dump. These samples were stored in polyethylene boxes of cylindrical geometry, which avoid any loses of radon. Besides of the slag samples, some sludges and drainage water samples were collected close to the waste piles; and some natural soils were sampled in the surrounding area one km far from the rubbish dump. All samples were stored for more than 23 days to achieve secular equilibrium between  $^{222}\text{Rn}$  ( $T_{1/2}=3.824$  days [5]) and its daughters ( $^{214}\text{Pb}$  and  $^{214}\text{Bi}$ ) in equilibrium with  $^{226}\text{Ra}$ .

## 2.2. Gamma-ray spectrometry

The gamma-spectrometry procedure we have applied in this work has been recently developed [6]. The gamma detector we have used for the measurements was a Reverse-Electrode Germanium type n with a relative efficiency of 31.4% and an energy resolution (FWHM) of 1.98 keV corresponding to 1,332 keV of  $^{60}\text{Co}$ . The activity concentration for a radionuclide in has been obtained using the widely used expression of [7]:

$$A = \frac{N}{t \cdot \varepsilon \cdot I \cdot w} \text{ (Bq kg}^{-1}\text{)} \quad (1)$$

Where A is the activity concentration of a certain radionuclide expressed in  $\text{Bq kg}^{-1}$ , N includes the net counts of a photopeak,  $\varepsilon$  is the counting efficiency of the used detector, t is the live time in seconds, I is the photon Intensity and w is the dried sample weight expressed in kg.

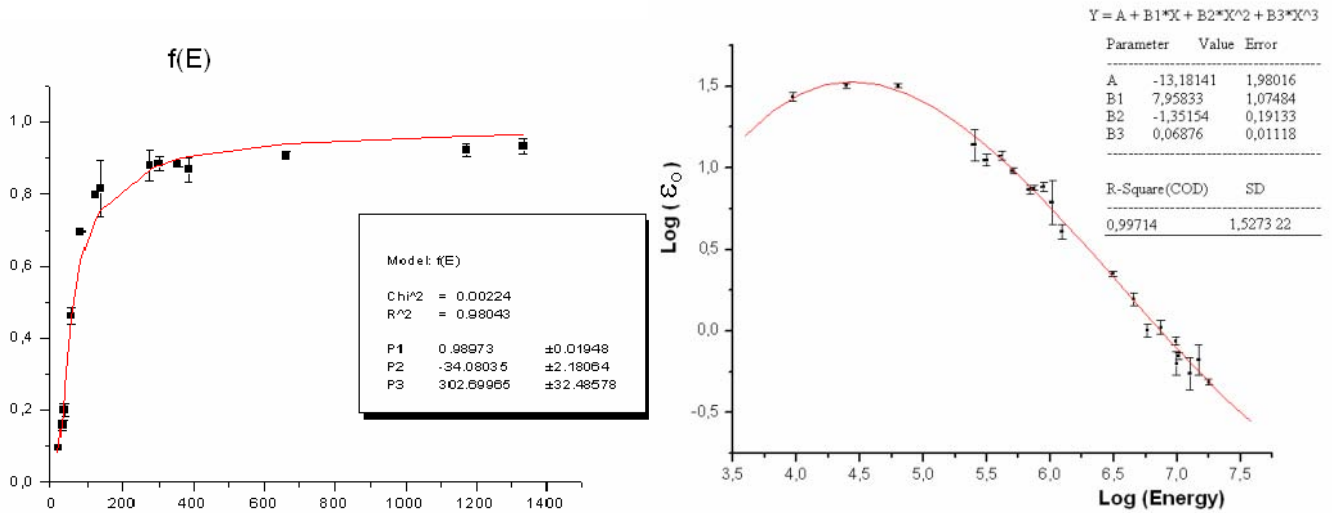

FIG 2. (a) Transmission factor  $f(E)$  fitted to Eq. (2). (b) Experimental efficiency curve we applied to soil samples (Energy is in KeV and  $\varepsilon_0$  in %).

The counting efficiency  $\varepsilon$  used in equation 1, was calculated using the following expression:

$$\varepsilon = f(E) \varepsilon_0 \quad (2)$$

Where  $f(E)$  is a self-attenuation correction factor and  $\varepsilon_0$  is the experimental efficiency corresponding to a full-energy peak, being E (keV) the energy, evaluated from a third order polynomial fitting:

$$\log\left(\frac{\varepsilon_0}{1}\right) = a + b \log\left(\frac{E}{1\text{keV}}\right) + c \left[\log\left(\frac{E}{1\text{keV}}\right)\right]^2 + d \left[\log\left(\frac{E}{1\text{keV}}\right)\right]^3 \quad (3)$$

The self-attenuation correction factor,  $f(E)$ , is obtained by transmission experiments with punctual sources and the measured samples [6, 8]. On this way, we obtain the self-attenuation correction factor  $f(E)$ , fitted to the equation:

$$f(E) = a + b/E + c/E^2 \quad (4)$$

All the measurements have taken a live time from  $10^5$  to  $1.5 \times 10^5$  seconds, whereas dead time have ranged from 0.01% to 0.05%. In sample's spectra where no searched peaks were found, the minimum detectable activity (MDA) was calculated according to Currie formula:

$$MDA = \frac{\sigma \sqrt{B}}{\varepsilon \cdot I \cdot t \cdot w} \quad (\text{Bq kg}^{-1}) \quad (5)$$

where B is the background for the region of interest (ROI) of a certain radionuclide and  $\sigma$  is the statistical coverage factor equal to 1.645 (confidence level 95%) [7].

# **NORM in drinking water, removal and radioactive waste generated**

**F. Schönhofer**

BMLFUW i.R.

Habicherg. 31/7

A-1160 Vienna, Austria

Email: [franz.schoenhofer@chello.at](mailto:franz.schoenhofer@chello.at)

**Abstract.** Drinking water is one of the most important foodstuffs and is consumed in large quantities. Therefore its quality is of vital importance. Among many other criteria its maximum content of radionuclides is in most countries strictly regulated. This paper gives a condensed overview of the radionuclides of importance, recommendations and legislation, the work done in Austria on this topic including a national standard, the possibility for removal of radionuclides from water and the problems which might occur from the removal.

## **1. Introduction**

Much attention has been paid to the radioactive fallout from nuclear bomb tests and emissions from nuclear power plants since the late 50's of last century. In the early 70's the impact of Rn-222 from building material and from ground was recognized to exhibit a much larger dose contribution. Though scientists have since the 80's pointed to the impact of Naturally Occurring Radioactive Material (NORM) as well as Technologically Enhanced Naturally Occurring Radioactive Material (TENORM) it lasted well into the 90's until recommendations and legislation were issued. One of the media, affected by NORM is drinking water, which is the most important foodstuff. The concentration of NORM radionuclides depends on many factors, but can in many areas not be neglected.

Actual doses from NORM in drinking water are with few exceptions considerably higher than any to be expected from artificial radionuclides. Even after the Chernobyl accident, drinking water tapped from ground water showed in Austria no artificial radionuclides – as opposed to drinking water sources from karstic areas and surface waters (1). NORM radionuclides in drinking water are generated as part of the natural radioactivity decay chains.

## **2. Recommendations and legislation**

The European Union has issued the Drinking Water Directive (2) and a recommendation as to Rn-222, Pb-210 and Po-210 (3). Information about the relative radiotoxicity of radionuclides can be found in the Radiation Protection Directive (4).

National legislation in the European Union has followed the EU Directive, some member states have adopted further provisions as to the concentration of Rn-222, Pb-210 and Po-210. These provisions cannot be discussed in the framework of this paper. Austria has implemented the Drinking Water Directive as is.

## **3. Situation in Austria**

In Austria several projects have been carried out concerning radioactivity of water and identification of possibly enhanced radiation risks, like indoor radon air concentrations and geological research. In Austria tritium concentrations in precipitation, surface water and drinking water have been measured since the 60's. All measurements of the most recent decades have shown, that all of those media have concentrations of tritium very far below the EU Indicative Parameter. Installations using tritium are well known and their potential environmental impact is well monitored.

Large scale measurements of waters especially for radon were done in Austria since the beginning of last century, when potential locations for radon-spas were searched for. Specific and systematic investigations of Rn-222 and Ra-226 concentrations were carried out in the late 80's and early 90's in geologically identified risk areas (5). A very limited number of results on Ra-228, Pb-210 and Po-210 is available but a large scale project is still missing.

#### 4. Austrian standard

The European Directive gives as Indicative Parameters both a maximum permissible tritium concentration of 100 Bq/L and an Indicative dose of 0.1 mSv/y. In order to assure compliance with these parameters a Working Group at the Austrian Standardisation Institute has prepared the Austrian Standard OENORM S 5251 (6), which is intended to facilitate the decision on compliance with the EU Directive. This standard applies to Austria, but it may be easily adopted for other countries according to their geographical, geological and drinking water distribution circumstances.

Several facts and reasonable assumptions have been used to formulate this Austrian Standard: Austria has neither a nuclear power plant in operation nor any kind of uranium mining, not to speak about any reprocessing of spent nuclear fuel. Occurrence of artificial radionuclides in drinking water is therefore more than unlikely, especially since use of sealed radionuclide sources in industry is strictly regulated and controlled. Therefore the Austrian Standard concentrates on NORM, though stating that in case of reasonable suspicion other possible sources have to be investigated. The two nuclear research institutes in Austria – Atominstitut in Vienna and ARCS Seibersdorf - are since their existence subject to very tight and special environmental surveillance.

Looking at the Radiation Protection Directive (4), the exemption values for NORM radionuclides demonstrate their relative radiotoxicity (Table 1).

TABLE 1. EXEMPTION VALUES FOR PRACTICES FOR NORM RADIONUCLIDES (Ref. (4))

Nuclide	Activity (kBq)	Activity concentration (kBq/kg)
K-40	1000	100
Pb-210+	10	10
Po-210	10	10
Ra-224+	100	10
Ra-226+	10	10
Ra-228+	100	10
Th-232sec	1	1
U-238+	10	10
U-238sec	1	1

The working group of the Austrian Standardization Institute chose the following approach, taking the Austrian situation and already existing information like risk maps into consideration: Contamination of drinking water by artificial radionuclides is with very few exceptions (tritium using industry) extremely unlikely, therefore these radionuclides can be disregarded. From Table 1 it can be easily derived, which radionuclides might be of concern – they are first of all Ra-226 and Ra-228. Rn-222 and both Po-210 and Pb-210 are other radionuclides of concern regarding their potential contribution to the dose of the population, but since the recommendation (3) has not been implemented into Austrian legislation, these radionuclides have to be disregarded. The Austrian Standard provides a guideline, based on rather simple measurements, how to verify whether the radionuclides in drinking water would cause an excess of the 0.1 mSv/y as defined as the indicative dose by the Directive (2).



## 5. Removal of radionuclides — radioactive waste

Within the framework of the European Union, the international project “TENAWA” (7) on the removal of NORM from drinking water was conducted. The main focus was laid on removal of NORM from household water in affected areas. Many common methods normally used for removal of other than radioactive contaminants were investigated and their removal efficiencies for radium, lead and uranium are summarized in Table 2.

TABLE 2. REMOVAL EFFICIENCIES FOR RADIUM, LEAD AND URANIUM

Treatment method	Ra	Pb	U
GAC Filtration	0 – 90	30 – 99	0 – 99
Cation Exchange	95 – 98	20 – 90	-
Anion Exchange	35 – 60	20 – 70	> 95
Mixed Bed Exchanger	95 – 98	20 – 90	> 95
Hydroxylapatit Filtration	35 – 95	75 – 95	58 - 82
Reverse Osmosis and Nano Filtration	> 95	> 95	> 95

During the control of a newly bored well in Austria the raw water was found to show Ra-226 in a concentration higher than the allowed value. At the same time the water contained significant concentrations of iron and manganese, which had to be removed in any case by oxidation and precipitation as hydroxides. Those hydroxides are known to be excellent scavengers for radium, so by removing iron and manganese automatically Ra-226 was removed. The sludge however contains both such high amounts and concentrations of Ra-226 that it constitutes radioactive waste. The authorities prescribed special precautions like strictly limiting access to the sludge storage tank because of the high radiation doses measured and disposal at the Austrian centre for radioactive waste. However it has to be kept in mind, that radionuclide concentrations in water fairly lower than the maximum permissible concentration might in the course of purification lead to the accumulation of radioactive waste.

## 6. Conclusions

There is good reason to control drinking water for radionuclides and especially naturally occurring ones, because in many cases the doses delivered to the population cannot be neglected. There exist methods to remove NORM from drinking water, but care has to be taken as to their accumulation in purification media and in sludges, which might result in the generation of radioactive waste.

## REFERENCES

- (1) F. Schönhofer et al. “Tschernobyl und die Folgen für Österreich” (in German), Austrian Environmental Protection Agency, Nov. 1986
- (2) Council Directive 98/83/EC, Official Journal L 330, 05/12/1998 p. 0032 - 0054

- (3) Commission Recommendation of 20 December 2001 on the protection of the public against exposure to radon in drinking water supplies (2001/928/Euratom)
- (4) Council Directive 96/29/Euratom of 13 May 1996 laying down basic safety standards for the protection of the health of workers and the general public against the dangers arising from ionizing radiation, Official Journal NO. L 159, 29/06/1996 P. 0001 – 0114
- (5) F. Schönhofer, "Measurement of Ra-226 in Water and Rn-222 in Water and Air by Liquid Scintillation Counting", Rad. Prot. Dos., Vol.45 No 1 / 4 pp.123-125 (1992)
- (6) Austrian Standard OENORM S 5251 (in German), Austrian Standardisation Institute, 2005
- (7) "Treatment Techniques for Removing Natural Radionuclides from Drinking Water" (TENAWA), CEC Contract No F14PCT960054

# Radiochemical characterization of the sludge from a treatment plant of potable water

M. Palomo, A. Peñalver, C. Aguilar\*, F. Borrull

Unitat de Radioquímica Ambiental i Sanitària, Universitat Rovira i Virgili  
Edifici CTT-FURV, Av. Països Catalans 18, 43007 Tarragona (Spain)

\*Corresponding author. Tel.: (+34) 977 559560; Fax: (+34) 977 558 446

Email: [carme.aguilar@urv.cat](mailto:carme.aguilar@urv.cat)

**Abstract.** Sludge samples from a potable water treatment plant (WTP), located in L'Ampolla (Tarragona, Spain), have been analysed to determine the activities from gamma natural radionuclides during a period of four years (from January 2002 to December 2006). In the analysed sludge, natural radioisotopes as K-40, Pb-214 and Bi-214, with activity values between 49.4 to 1391.0 Bq/Kg were the most commonly detected. Some artificial radioisotopes (Cs-137 and Co-60) were also found, with lower activities than the natural radioisotopes (between 1.9 and 76.0 Bq/Kg).

## 1. Introduction

Water from surface and underground sources may contain small amounts of naturally occurring radioactive materials (NORM) of uranium, thorium, radium and potassium. Moreover, if some industrial activities are placed in the areas of interest of these waters, an increase in the levels of these radionuclides can occur. As the result of this concentration originated by human activities, these materials are classified as TENORM (technologically enhanced naturally occurring radioactive materials) [1]. When the water is treated, the small amounts of radioactivity present in the source water may concentrate in the sediments or the sludge produced.

The knowledge of the leachability of the NORM is important to estimate their contribution to the food chain and other water dependent pathways such as drinking water and ground water. In this sense, the determination of sludge radioactivity levels coming from a water treatment plant can be a very valorous task. Sludge can be a sensitive indicator of the entry of some radionuclides into water treatment plants [2,3].

Ebro river is one of the most important rivers in Spain which is located in the north-east part of the country. In its course are present some different industrial activities, as a fertiliser industry or a nuclear power plant. Before entering into the sea, river water is treated in the water treatment plant (WTP) of L'Ampolla (Tarragona), with the aim to fulfil with the required Spanish quality criteria for waters intended to human consumption [4]. In this way, the purpose of water treatment facilities is to reduce or remove pollutants from water in order to ensure adequate water quality before its use. However, in the normal operation of these plants, sludge is produced so the processes involved in a WTP can reconcentrate radioactive materials in them. For this reason, the analysis of these samples can provide valuable information about the radionuclides which can be present in the water treated even that at low levels of activity, so with the standard methods of analysis normally used in the laboratories can not be detected.

The main aim of this study was to monitor the radioactive content in the sludge coming from potable water treatment plant of L'Ampolla (Tarragona), during a period of four years (2002-2006), in order to obtain a radiological characterisation of the samples. The natural radioisotopes selected for this study were some of the most abundant in the environment such as K-40, Pb-214 and Bi-214. Some characteristic artificial radioisotopes (like Cs-137 and Co-60) in the environment were also included in this selection.

## **2. Experimental procedure**

### ***2.1. Standards and materials***

The sample collection process is explained in section 2.4. The material used for this are: a stove provided by Memmert (Spain), the sludge is passed through a balls mill supplied by Herzog Company (Ohio, US). And finally, the sludge is passed through a sift model FT-91 (42 Mesh) supplied by Herzog Company too.

A certified solution of gamma emitters (QCY-48) provided by Isotrak (Harwell, UK), and composed by ten gamma isotopes covering an interval of energy between 60 to 1836 KeV was used for gamma spectrometry calibration. This standard sample was kept in a Marinelli of 500 ml supplied by Tecnasa (Madrid, Spain).

### ***2.2. Detector***

Gamma emitters were measured by using a high-resolution germanium detector (model 2020 Canberra Industries from Meriden, USA), with a standard multi-channel analyzer. The operating conditions were a voltage of 4500 KeV with a negative polarity and a relative efficiency of 20%. Genie 2000 software (Canberra Industries, Meriden, USA) was used for the acquisition and posterior analysis of the information provided by the gamma spectra.

### ***2.3. Calibration***

Gamma standard solution was used for energy and efficiency calibration. To carry out the calibration, the standard solution was measured. Background was evaluated by measuring 500 ml of desionized water. The counting time of the standard, background and the samples was 20 hours.

### ***2.4. Sampling and pre-treatment***

Sludge samples were taken monthly from the water treatment plant located in L'Ampolla (Tarragona, Spain), during a period from January 2002 to December 2006. One litre of sludge from the entrance chest was taken every day, and then, water was eliminated. Sludge was transferred to a tray and to dry it was introduced in a stove at a temperature of 110°C. Every day, and during a month, the procedure was repeated. At the end of the month, the dried sludge was homogenised and a fraction of 500 g was crushed in a ball mill and sieved in a sift. Finally, 500 g of the sample was introduced in a Marinelli beaker, and measured in the high-purity germanium detector (HPGe) during 20 hours.

## **3. Results and discussion**

In the treatment carried out in WTP of L'Ampolla (Tarragona, Spain), water is potabilized an as a consequence of this, sludge is produced and accumulated. Sludge can concentrate heavy metals present in the river water, such are some radioisotopes.

The main aim of this study was the radiological characterisation of the sludge from the potable water treatment plant of L'Ampolla. For this purpose, 60 sludge samples covering a period of four years (from January 2002 to December 2006) were analysed with a frequency of one sample for month. Water entering and coming out from this plant was also analysed monthly. In the case of water samples, the activity values obtained were in general lower than the minimum detectable activity (MDA), but in the case of the sludge samples the activity values were higher and could be quantified. This can be due to the accumulation of the radionuclides in the sludge, in particular those which are heavy metals. Sludge from WTP may be used as a fertiliser on agricultural land and although this use presents potential resource and environmental advantages, it can have negative effects on people and soil productivity. In this way, the sludge radiochemical characterisation is important to know the

possible presence of radioisotopes in the water and also in the sludge for knowing their environmental impact [5].

### 3.1. Calibration

Before analysing the sludge samples, it was necessary to calibrate the HPGe gamma detector. The objective of this calibration was on one hand the identification of the radionuclides (energy calibration) for a posterior qualitative determination and, on the other hand, the determination of their activity (efficiency calibration) for a posterior quantitative determination. Calibration was carried out with a standard solution composed by ten gamma emitters (QCY-48) and the background was measured with deionised water.

Aqueous standards are more commonly used for the calibration of gamma spectrometry detectors for two reasons: their relatively low self-attenuation at energies above 50 keV, and because they are easily homogenized and conditioned to different detector geometries [6]. The density of the sample is an important parameter that has an influence in the efficiency calibration for the gamma calibration of each radionuclides. In our study, even that the sample was solid, calibration was performed with water standard since the density of water and sludge were comparable, around 1 g/ml.

### 3.2. Sludge radiochemical characterization

In order to radiochemically characterize the sludge sample, some natural and artificial gamma radioisotopes were measured. Among the natural isotopes some of the radioisotopes belonging to the Th-232 decay chain (Ac-228, Bi-212, Pb-212 and Tl-208) and to the U-238 decay chain (Ra-226, Pb-214 and Bi-214) were selected. Moreover, K-40, which is present in the earth since its origin, and Be-7, that is formed continuously in the atmosphere through the cosmic radiation interaction with the atmospheric nuclei [7] were also included in this study. As artificial isotopes, those which are relevant in some industrial human activities, atmospheric nuclear bomb tests, nuclear accidents and radioisotopes utilised in nuclear medicine were included. Table 1 shows the radioisotopes selected for this study and also their gamma emission energy.

TABLE 1. GAMMA EMISSION ENERGIES OF RADIOISOTOPES IN THIS STUDY

	Energy (keV)	Type
Ac-228	911.6* and 969.1*	natural
Be-7	477.6*	artificial or natural
Bi-212	727.7*	natural
Bi-214	609.3*, 1120.3 and 1764.5	natural
K-40	1460.8*	natural
Pb-212	77.1 and 238.6*	natural
Pb-214	295.2 and 351.9*	natural
Tl-208	583.14*	natural
Cs-137	661.65*	artificial
Co-60	1173.21 and 1332.48*	artificial

\*Energy line used for quantification

A total of 60 samples were taken during the period of time that lasted this study and they were analysed monthly. As an example, Figure 1 shows the gamma spectrum of one of the sludge samples analysed, in particular the corresponding to the sample obtained in June 2006. For the rest of the analysed samples, the obtained gamma spectrum was similar. As can be observed through the spectrum, some of the peaks that appear could be identified as some of the

radionuclides included in the study. Among them, it should be pointed out that some present more than one gamma emission line, as Bi-214 or Pb-214, whereas other radioisotopes emit in the same energy line, as Ra-226 and U-235. Through the spectrum, it can be remarked that the main gamma contribution corresponds to the natural isotopes of the uranium and thorium decay chains and also to K-40. However, in the radiochemical content of these samples there is also a contribution from some artificial radionuclides, like Co-60, Co-58 or Cs-137.

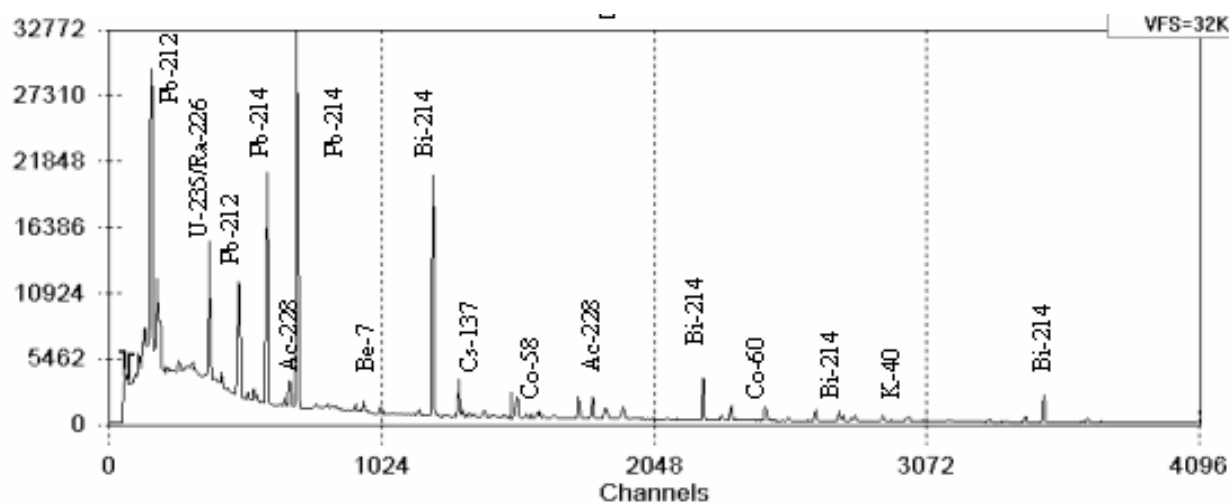

FIG 1. Gamma spectrum of the sludge from the potable water treatment plant of L'Ampolla corresponding to June 2006. For experimental conditions, see text.

Table 2 shows the obtained activity values for the NORM during the period of time evaluated in this study. In this table, the minimum, the maximum and the average activities (in Bq/kg) for the natural radioisotopes determined in the analysed samples on the period between 2002 and 2006 are shown. The uncertainty values associated to the activities shown in Table 2 were calculated using a level of confidence of 95 % (K=2).

TABLE 2. MEAN ACTIVITY CONCENTRATIONS IN WATER TREATMENT SLUDGE (The uncertainty is calculated using a confidence level of 95% (K=2))

	Activity concentration (kBq/kg)		
	Minimum*	Maximum*	Average**
Ac-228	65 ± 2	194 ± 4	128 ± 3
Be-7	16 ± 11	230 ± 11	88 ± 7
Bi-212	16 ± 2	45 ± 7	26 ± 5
Bi-214	44 ± 8	693 ± 11	287 ± 9
K-40	157 ± 14	1391 ± 6	298 ± 35
Pb-212	4,1 ± 0,7	45 ± 2	30 ± 1
Pb-214	49 ± 11	726 ± 16	293 ± 7
Tl-208	9 ± 4	19 ± 1	12 ± 1

\* Measurement uncertainty

\*\* Internal combined uncertainty

Among the different natural isotopes which were determined, K-40 was found to be one of the most abundant with activity values ranging between 157 and 1391 Bq/Kg. These relatively high activities can be related to the high content of potassium in the analysed samples due to the presence of salts and minerals of this element in the sludge. Their origin can be associated to the use of fertilisers for agricultural purposes and to other industrial activities [8]. In fact, K-40 is one of the most abundant natural radioisotopes in different kinds of samples, as sludge, sediments and soils, and its presence has been confirmed for several authors. For example, Navas et al. [9] found activity values between 34-

1094 Bq/Kg in soil samples from Spanish Pyrenees, and Sadasivan et al.[10] quantified the gamma activity due to this isotope in the interval between 335-562 Bq/kg in Indian soils. The different origin of the evaluated samples is an important factor that influences in the results obtained for different authors. Moreover, the results reported for these authors show the K-40 great influence in the global radiological content of the tested samples. Potassium has a high affinity to the soil; the concentration associated with soil particles is estimated to be 15 times higher than in the interstitial water [7].

Other natural radioisotopes which showed activity values higher than the MDA were Pb-214 and Bi-214, with activities ranging between 49.4-726.4 Bq/Kg and 44.3-693.0 Bq/Kg, respectively. Both isotopes belong to the natural decay chain of U-235, and they are descendants of radium, so their presence can be associated to the presence of Ra-226. Ra-226 is difficult to be directly quantified with gamma spectrometry, because its emission line coincidences with one of the U-235 emission line. One way to determine Ra-226 activity with gamma spectrometry is through Pb-214 and Bi-214 activities when all three isotopes are in secular equilibrium [11]. In this sense, Figure 2 shows that Bi-214 and Pb-214 behave in the same way when they reach a secular equilibrium, which occurs after a period of time of 25 days.

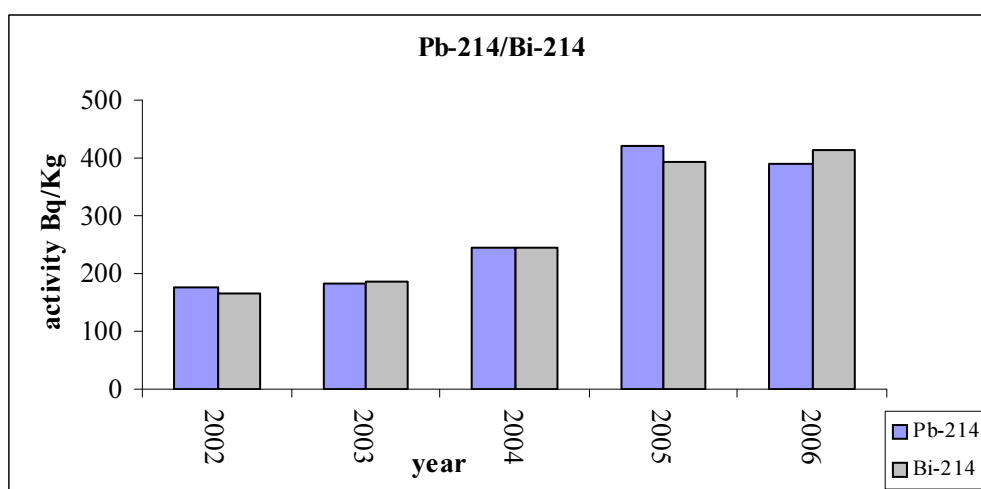

FIG. 2. Relationship between the average activity values of Bi-214 and Pb-214 during the period of time evaluated.

Radium and its descendents are produced by the radioactive decay of uranium and thorium, and this occurs primarily in rocks bearing those elements, most notably the silica (alkaline) igneous rocks, pegmatites, and certain hydrothermal veins [7]. River water drags these metals and finally they can be accumulated in the produced sludge of the water treatment plant or also in some sediment samples. For example, Tsabaris et al. [11] have found activity values between 13.9-25.6 Bq/Kg, 11.4-21.0 Bq/Kg and 7.9-19.3 Bq/Kg for, Pb-214, Bi-214 and Ra-226 respectively in sediment samples from Albania coast; thus demonstrating the accumulation of these isotopes in solid samples.

Actinium-228 is a short-lived isotope (6.13 h) which is the daughter of Radium-228 that originates in the thorium decay chain. In sludge samples, Ac-228 was detected with activity values between 65 and 194 Bq/Kg. Our activity levels were higher than the activity values reported from several authors in bibliography. For example, Martín et al. [12] analysed Spa sludge from the area of Extremadura (Spain) obtaining average activity values of this isotope of 11 Bq/Kg. Even the differences in the obtained values, Ac-228 can be used in all the cases as a useful indicator of a high content of Ra-228 in the analysed samples.

Other natural isotopes as Pb-212, Bi-212 and Tl-208, were also detected, with lower activity values than the other natural isotopes found, between 4-45, 16-45 and 9-19 Bq/Kg, respectively. Secular equilibrium of the Th-232 series is a reasonable factor to consider since Th-232 has a long half-life and it is present since the formation of the Earth [13]. Tsabaris et al. [11] found activities values for

Pb-212, Bi-212 and Tl-208 between 13.1-39.5 Bq/Kg, 13.3-40.0 Bq/Kg and 13.1-38.1 Bq/Kg respectively in sand from Butrint Lagoon. These values were in the same order to the values found in this study.

Finally, Be-7 is another natural radioisotope found in most of the analysed samples. It is a naturally occurring radioisotope produced by interactions of cosmic radiation and the upper atmosphere. Be-7 can enter into the water system through the water supply and from rain water [14]. In our samples, Be-7 activities values were between 16 and 230 Bq/Kg. Salih F.M. et al. [15] realised a baseline study in sewage sludge from a sewage treatment plant from Sultanate Oman, and they found activity values between 2-40 Bq/Kg for this radioisotope. Another study, carried out by Sanchez Cabeza et al. [2] showed in general lower activity values, between 1.1 and 7.2 Bq/K when marine sediments were analysed. In this case, the difference between the different studies can be related to the origin of the samples and as expected, for samples which are not exposed to the cosmic contribution the content of Be-7 is lower.

In almost all the analysed samples, some artificial radioisotopes were also found. In particular they were Cs-137 and Co-60 with activity values in the range between 0.9-6.4 Bq/Kg and 2.0-33 Bq/Kg, respectively. Cs-137 and Co-60 can be considered as some of the most hazardous radionuclides in the environment and some of the most dangerous products produced by nuclear fission. In the last years, these radionuclides also have been used in medicine for different applications. These isotopes have been previously detected in soil samples which were taken in the area of influence of Ebro river (where is located the water treatment plant of L'Ampolla), in particular in the surroundings of the nuclear power plant of Ascó. The Consejo de Seguridad Nuclear (CSN), is the Spanish organisation dedicated to the study and control of the radioactive contamination in the zones near the nuclear power stations. CSN organises every year the national program of environmental radiological monitoring in which Cs-137 and Co-60 determination in different environmental samples is included. The activity values provided by this Spanish organisation were between 0.4-3.0 Bq/Kg for Cs-137 and 0.43-4.74 Bq/Kg for Co-60, in soil samples taken around the nuclear power station of Ascó.

#### **4. Conclusions**

The activity levels due to some natural and artificial gamma emitters was determined in sludge samples from the water treatment plant located in the area of the Ebro river in L'Ampolla (Tarragona) between January 2002 and December 2006.

The results obtained after the four-years monitoring revealed that the major contribution the radioactivity can be attributed to a natural origin. In this sense the natural decay chains, in particular the U-235 chain, contribute to the higher percentage of radionuclides (such as Ra-226, Pb-214 and Bi-214). Moreover, other natural radioisotopes as K-40 and Be-7 have been detected with relatively high activities.

Some artificial radioisotopes, mainly Cs-137 and Co-60, were also detected in almost all the analysed samples. Their origin could be related to the industrial activity of the area under study and/or to medical applications. The activity values found for them were much lower than the values of the natural emitters in the analysed samples and similar to the obtained for different samples analysed in that area.

The results obtained in this study have enabled to start the radiological characterisation of Ebro river water and sludge to control the radionuclides present in these samples and their effect in the environment. Even that the activities found in this study do not represent any danger for the population, it would be necessary to continue this study with the aim of getting better radiological information of this area. Further studies to investigate the efficiency of water treatment plants in the removal of the radioisotopes present in the incoming river water will be very helpful to prevent radiological risks to population.



## REFERENCES

- [1] PARANHOS GAZINEU M.H, ARRUDA DE ARAUJO A, BATISTA BRANDÃO Y, ABRAHÃO HAZIN C, GODOY J.M. Radioactivity concentration in liquid and solid phases of scale and sludge in petroleum industry. *J. Environmental Radioactivity* 81 (2005) 47-54.
- [2] SANCHEZ-CABEZA J.A, MOLERO J. Plutonium, Americium and radiocaesium in the marine environment close to the Vandellós I nuclear power plan before decommissioning. *J. Environmental Radioactivity* 51 (2000) 211-228.
- [3] PUHAKAINEN M. Detection of radionuclides in sewage water and sludge. *Radiochemistry*, 40, 6 (1998) 529-533.
- [4] Real Decreto 140/2003, Boletín Oficial del Estado n.45, 21 de Febrero del 2003, 7228-7245.
- [5] PRIESNITZ W. The real dirt on sewage sludge. *Natural life Magazine* 1997.
- [6] HERNÁNDEZ F., EL-DAOUSHY F. Photon sources with minimised absorption for the calibration of semiconductor detectors. *Nuclear Instruments and Methods in Physics Research. Section A* 488, 1-2 (2002) 258-261.
- [7] SHABAN M.H. Doctoral Thesis. On the human radiation exposure as derived from the analysis of natural and man-made radionuclides in soils. Universität Hannover, Hannover 2004.
- [8] MAXINO G.C. Communication in the 3er Samahang Pisika ng Visayas, Mindanao National Physics Conference, Ateneo de Zamboanga University, Zamboanga City, 23-25 October 2001.
- [9] NAVAS A, SOTO J, MACHÍN J.  $^{238}\text{U}$ ,  $^{226}\text{Ra}$ ,  $^{210}\text{Pb}$ ,  $^{232}\text{Th}$  and  $^{40}\text{K}$  activities in soil profiles of Flysch sector (Central Spanish Pyrenees). *Applied Radiation Isotopes* 57 (2002) 579-589.
- [10] SADASIVAN S, SHUKLA V.K, CHINNAESAKKI S, SARTANDEL S.J. Natural and fallout radioactivity measurements in Indian soils. *J. Radioanalytical and Nuclear Chemistry* 256, 3 (2003) 603-607.
- [11] TSABARIS C., ELEFThERIOU G., KAPSIMALIS V., ANAGNOSTOU C., VLASTOU R., DURMISHI C., KEDHI M., KALFAS C.A. Radioactivity levels of recent sediment in the Butrint Lagoon and the adjacent coast of Albania. *Applied Radiation and Isotopes* 2006
- [12] MARTÍN A., VERA F., ORANTOS R.M., GÓMEZ V., FURADO M. Gamma and Alpha Spectrometry for natural radioactive nuclides in the sap waters of Extremadura (Spain). *J. Environmental Radioactivity* 28, 2 (1995) 209-220.
- [13] MILLER W.H., KUNZE J.F., BANERJI S. K. AND YU-CHU LI. The determination of radioisotopes levels in municipal sewage sludge. *Health Physics*, 71, 3 (1996) 286-289.
- [14] BRENNAN M.J. The presence of radionuclides in sewage sludge and their effect in the human health. *Environmental Radiation Program* 1997.
- [15] SALIH F.M., PILLAY A.E., JAYASEKERA K. Be-7 levels in sewage sludge: A baseline study. *Instrumentation science and Technology* 32,4 (2004) 433-444.



## **NORM waste disposed in an underground salt mine**

**J. Dörfel**

Umwelt, Entsorgung und Verwertung GmbH (UEV)  
Germany

The SWS (Südwestdeutsche Salzwerke AG), our joint-stock company, is winning salt in the rock salt mines of the cities Heilbronn and Kochendorf in Germany for over hundred years. The state of Baden-Württemberg and the city of Heilbronn are up to 95 % the shareholders of the company. Up to now mining created a volume of more than 60 million cubic meters cavities underground. Those cavities represent valuable resources that are used for waste disposal by high safety standards for years.

Rock salt is mined in our area at a depth of 200 meters, only the lower part of about 40 meters salt seam is excavated. The chambers resulted from it have a size of approximately 15 meters x 200 meters and a height of 18 meters. They have been used for disposal since 1986.

The UEV (Umwelt, Entsorgung und Verwertung GmbH) was founded in 1992 in order to develop the opportunity provided by the void space. The provision of the environmental services is supported by partner companies, subsidiary companies and through investment at home and abroad. It is also possible to refill the mine with a number of mineral wastes in the Kochendorf as a result of a special German mining approval as well as in the Heilbronn underground waste repository as a consequence of its consent.

The Kochendorf and Heilbronn mines have an official proof that the waste is securely isolated, long-term safe and completely isolated from the biosphere. By this way an ecologically beneficial disposal of the waste is guaranteed. The waste requires harmlessness in handling and the geomechanical suitability. We already use for example: typically fly ash, slag, building rubble, soils and foundry sands. Those wastes can be dumped directly usually without big efforts in treatment (Figures 1 and 2).

If the waste cannot be recovered neither for technical nor for lawful reasons, it can be stored in the Heilbronn underground waste repository. All of the waste is there stored in suitable vessels. Those are for example big bags, 200 liters steel drums or metal containers (Figures 3 and 4). Approximately 500 different European waste codes are authorized for the underground waste repository.

The wastes, packaged in big bags, drums or metal containers, are transported underground by shaft cage-lifts and forklifts, than trucks carry the wastes to their final position. The chamber is filled from the far end towards the entrance. After then the wastes are covered with tailings of salt (Figures 3 and 6). In this way the chamber are filled layer for layer.

So we can dispose for example wastes out of a melting-plant for chemically contaminated scrap, which could also be polluted with NORM substances. In order to use the wastes of NORM materials, a radiological report must confirm that the wastes complies with the European acceptance criteria for underground disposal. As second criteria is now the limit for disposal in underground salt mine in Germany of 5 Bq/g for NORM waste.

Through the currently covering by tailings of salt and finally the hermetic closure of each chamber the potential paths of exposure can be excluded.



*FIG. 1. Dumping of bulk material*



*FIG. 2. Covering bulk material with tailings of salt*



*FIG. 3. Refilling with large bags*



*FIG. 4. Storage of drums*



*FIG. 5. Covering large bags with tailings of salt*



*FIG. 6. The remaining space of a chamber is infilled by tailings jettied in*

# Activity ratios of natural radionuclides as markers of changes in the policy of NORM wastes released by industries located in the south-west of Spain

E.G. San Miguel<sup>a</sup>, J.P. Bolívar<sup>a</sup>, R. García-Tenorio<sup>b</sup>

<sup>a</sup>Dept Física Aplicada,  
University of Huelva,  
Huelva, Spain

<sup>b</sup>Dept Física Aplicada II,  
E.T.S. Arquitectura,  
University of Seville,  
Sevilla, Spain

**Abstract.** The Huelva estuary (south-western Spain) is formed by the confluence of the Odiel and Tinto river mouths in the Atlantic Ocean, where a large industrial chemical complex was built in the sixties, which comprised of two rock phosphate processing plants to produce phosphate fertilisers. From the beginning of 1960's to 1997, these plants have released large amounts of wastes and by-products, mainly phosphogypsum (about 2.5 millions tons per year). About 20 % of this amount was directly released into the estuary waters, while the remaining 80 % have been stored in large piles located in their surroundings. These gypsum stacks cover now an area of about 1200 Ha. In 1997, the waste management policy changed. A new water recycling system was introduced in order to minimize the environmental impact of this activity on the estuary. Nowadays, the water follows a closed circuit thereby avoiding the transfer of radionuclides into the environment. The radioactive impact of these NORM industries has been recorded in the sediments of the area. The study of both the  $^{226}\text{Ra}/^{228}\text{Ra}$  and  $^{230}\text{Th}/^{232}\text{Th}$  activity ratios, in sediment profiles has been used to delimitate the influence of the wastes from the rock phosphate processing plants in the Huelva estuary. The chronology obtained based on  $^{137}\text{Cs}$  profile reflects the historical impact of these NORM industries in sediments of the area. The change of the waste policy has been also reflected by variations in the values of these isotopic ratios. From the information provided by these activity ratios it is possible to conclude how good the policy waste changes are.

## 1. Introduction

During the past ten years, the law regulations concerning radioactivity have suffered a trend to minimize the dose limits received by both population (non-occupational) and workers (occupational). The situation of many industries and their associated wastes involved in the management of NORM (Naturally Occurring Radioactive Materials) has to be evaluated to guarantee the safety of the population and workers. A well-known example of NORM-related processes is that of the facilities devoted to the production of phosphate fertilizers. These are manufactured from phosphate rock, which contains high concentrations of radionuclides from  $^{238}\text{U}$ -Series [1]. The  $^{238}\text{U}$  concentration in phosphate rock is up to 100 times higher than in the average United Nations soil [2].

The major by-product in the industrial process of rock phosphate to manufacture phosphate fertilizers is the so-called phosphogypsum (PG), consisting in a  $\text{CaSO}_4 \cdot 2\text{H}_2\text{O}$  matrix. During the process, the different radioactive isotopes released from the raw material follow either the phosphate oxide or the generated by-product. Uranium present in the phosphate rock solubilizes and goes into the phosphoric acid fraction and  $^{226}\text{Ra}$  is co-precipitated with the phosphogypsum, which is usually stored in land surface areas close to the processing plants. It has been found that the major rates of Ra and Po isotopes (about 90%), a large rate of thorium isotopes (70%) and a minor fraction of U isotopes (~15%), follow the by-product [3].

### 1.1. Study area

The Tinto and Odiel rivers flow through Huelva province (southwest of Spain) from north to south, forming at their mouth, the Huelva Estuary (Fig. 1). In the proximities of Huelva Town (population of 150000 habitants) is located a large industrial complex, which includes among

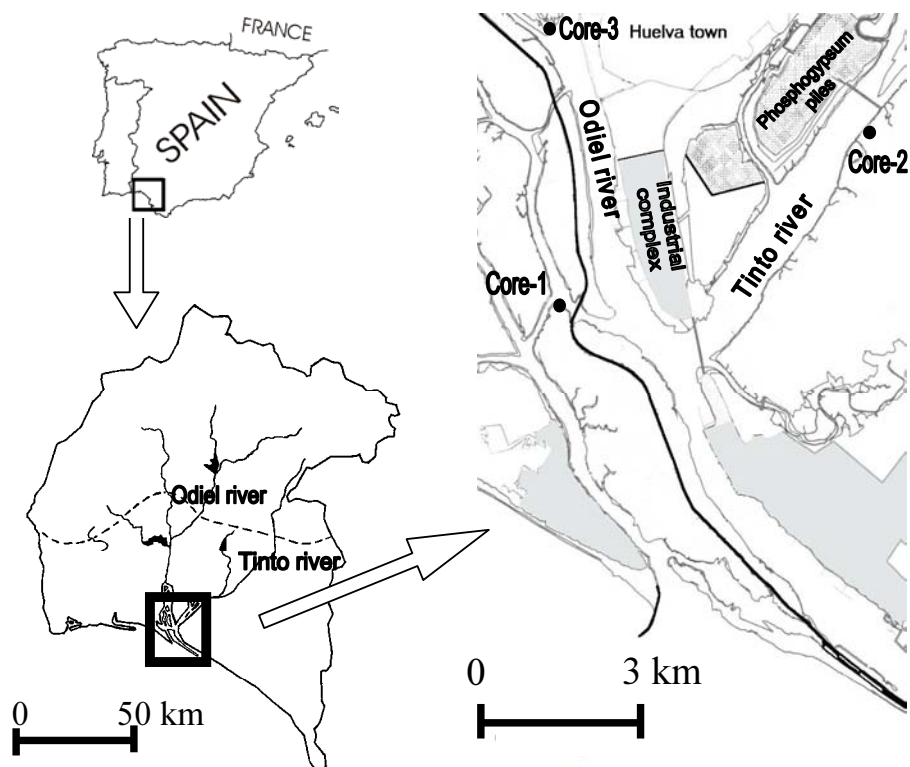

FIG. 1. Map of the Huelva estuary and locations of sediment cores.

others several plants dedicated to the extraction of Cu and/or Fe, production of sulphuric acid, an oil refinery and two phosphate rock processing plants (see references [4] and [5] for details). The phosphate rock processing plants have released a total amount of about  $90 \cdot 10^6$  tonnes of PG. Two ways were used to release the by-product from the plants until a recent date: 1) around 20% of the wastes produced by the phosphate rock processing plants have been released directly to the Odiel river; 2) the remaining 80% have been pumped, mixed in a river water solution (up to 20% phosphogypsum), to be stored in phosphogypsum piles formed near the plants [6]. The wastes released for forty years to the river and its surroundings have led to a clear enhancement of radionuclide concentrations from U-series radionuclides in different compartments of the area [4],[5],[7]. In 1997, the waste management policy changed. A new water recycling system was introduced in order to minimize the environmental impact of this activity on the river system. In nowadays, the water follows a closed circuit avoiding any transfer of radionuclides into the environment.

The aim of this work is to show the usefulness of Thorium isotope ratios ( $^{230}\text{Th}/^{232}\text{Th}$ ) and Radium isotope ratios ( $^{226}\text{Ra}/^{228}\text{Ra}$ ) as indicative of the historical impact of phosphate rock processing plants in sediments of the Huelva estuary. As a consequence, these activity ratios allow to infer if the changes introduced in the waste policy are effective or not from the point of view of pollution of water and sediments of the Huelva estuary.

## 2. Materials and methods

### 2.1. Sampling and pre-treatment

In different zones of the estuary three sediment cores were recorded (Table 1, Fig. 1). They were collected using a cylindrical home-made corer with an inner diameter of 11 cm (with the exception of core 1 whose diameter was 6.5 cm), sealed in plastic bags and immediately frozen. In the laboratory, the frozen cores were cut into sections 1-2 cm thick, removing the outer layers of every



slice in contact with the tube. The porosity  $\phi$ , solid density  $\rho_d$  and (dry) bulk density  $\rho$  were determined in each section according to standard procedures [8].

TABLE 1. CORE LOCATIONS AND DATES OF COLLECTION

Sample	Latitude (N)	Longitude (W)	Collection date
Core 1	37° 13' 00"	6° 58' 12"	1994
Core 2	37° 14' 49"	6° 53' 41"	1999
Core 3	37° 16' 47"	6° 57' 37"	2004

## 2.2 Radionuclide activity measurements

For radionuclide determination, Aliquots of the sediment cores sections were chosen after homogenisation and grinding. Thorium-isotope specific activities were determined in the different sections of the sediment cores by alpha-particle spectrometry, while  $^{226}\text{Ra}$ ,  $^{228}\text{Ra}$  and  $^{137}\text{Cs}$  activities were obtained by gamma-ray spectrometry.

### 2.2.1. Gamma-ray spectrometry

Gamma-ray measurements were performed using an XtRa coaxial Ge detector (Canberra), with 38% relative efficiency and resolution (FWHM) of 0.95 keV at the 122 keV line of  $^{57}\text{Co}$  and 1.9 keV at the 1333 keV line of  $^{60}\text{Co}$ . The detector was attached to a conventional electronic chain, including a multichannel analyser, and was shielded with Fe 15 cm thick. An original efficiency calibration procedure was carried out in the energy range of 150-1800 keV [9].  $^{226}\text{Ra}$  activities were determined via the 352 keV emission of  $^{214}\text{Pb}$ . Both nuclides were in secular equilibrium since counting was done at least one month after filling and sealing the sample container.  $^{228}\text{Ra}$  determination were carried out by the emission of 911 keV of  $^{228}\text{Ac}$ , which is in secular equilibrium with its precursor.  $^{137}\text{Cs}$  activities were determined by its 662 keV gamma photons.

### 2.2.2. Alpha spectrometry

Thorium isotopes mass activities were determined in the samples by alpha-particle spectrometry. The measurements were carried out after the application of a radiochemical method to isolate the Th in aliquots of cores sections. The radiochemical method was originally developed by Holm and Fukai [10] and slightly modified for the purification of the Th fraction by Bolivar et al. [3].

The Th planchets were measured using an EG&G Ortec alpha spectrometry system with ion-implanted silicon detectors. Counting times ranged from two days to one week, depending on the activity concentrations and the recovery obtained in the chemical separation.

## 3. Results and discussion

Fig. 2 shows the vertical profiles of thorium isotope ratios (core 1) and radium isotope ratios (cores 2 and 3). Thorium isotope ratios and radium isotope ratios provided the same information about the influence of releases of phosphate rock processing plants in sediment cores of Huelva estuary [11]. The advantage of using the  $^{226}\text{Ra}/^{228}\text{Ra}$  activity ratio profile instead of the Th-isotope profile is that it can be determined through a non-destructive, simpler and less time-consuming technique because activities of both Ra isotopes can be obtained by gamma-ray spectrometry. In the case of core 1, the information about the influence of the releases of phosphate rock processing plants were determined through the thorium isotope ratios. Due to the smaller diameter of this core we were not able to obtain mass enough from each layer to reach MDA (Minimum Detectable Activity) levels by gamma spectrometric determinations of  $^{226}\text{Ra}$  and  $^{228}\text{Ra}$ , therefore thorium isotopes ( $^{230}\text{Th}$ ,  $^{232}\text{Th}$ ) were determined by alpha spectrometry in this core.

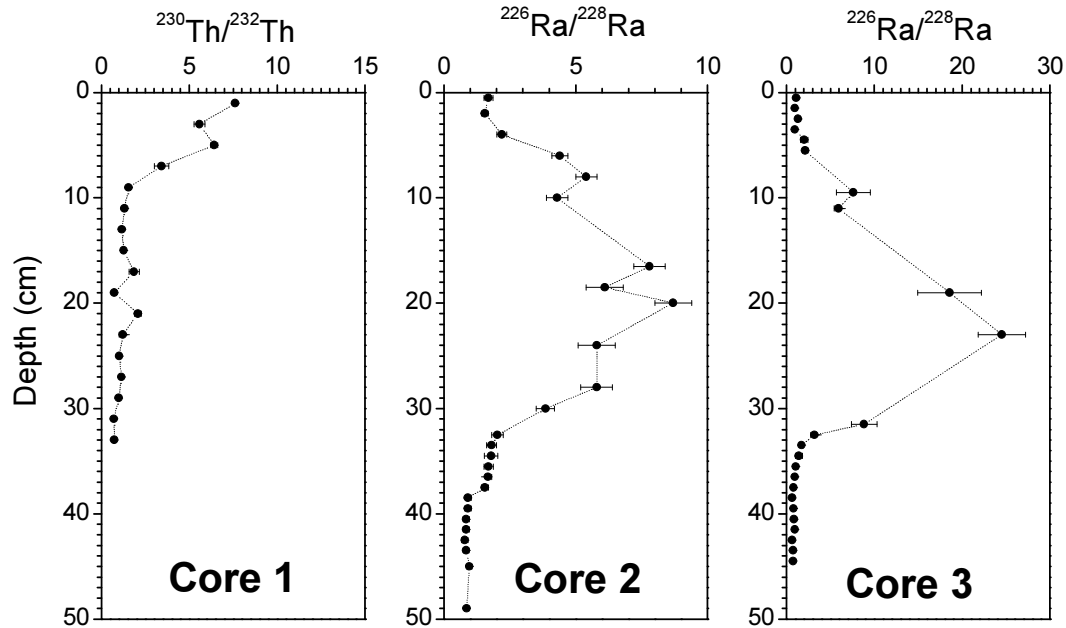

FIG. 2. Vertical profiles of Th-isotopic ratios in core 1 and Ra-isotopic ratios in cores 2 and 3

As it can be seen from Fig. 2 the thorium isotope ratios values show an increase in the layers above the 8-10 cm one. This increase is due to the releases of phosphate rock processing plants. In this way, it is possible to assume that layer 8-10 cm was formed just before the plants began the releases to the Huelva estuary. The most superficial layer of core 1 is heavily polluted since the value of Th-isotopic ratio is  $7.61 \gg 1$ , which is the typical value of uncontaminated sediments. This fact can be explained because this sediment core was recorded in 1994, therefore the most superficial layer of core 1 was formed prior to the change of the waste policy in the year 1997 and, as consequence, it has been affected by the wastes.

In the case of core 2 the  $^{226}\text{Ra}/^{228}\text{Ra}$  vertical profile shows a significant increase in layer 37-38 cm that can be associated to the beginning of the releases of the phosphate rock processing plants. As it can be seen from figure 2 the values of Ra-isotopic ratios in layers 0-1 cm and 1-3 cm are still significant higher than 1 but it is clear than an abrupt change has occurred above layer 5-7 cm. In this layer  $^{226}\text{Ra}/^{228}\text{Ra} = 4.4$  indicating a clear contamination due to the releases. Taking into account that this sediment core was recorded in 1999, two years after the change in the waste policy, the significant decrease of the Ra-isotopic ratio can be attributed to this change. Nevertheless, the values of this ratio are still slightly higher than one in layers 3-5 cm and 0-1 cm. This is probably due to sediment resuspension because although there are not direct releases to the Huelva estuary, the sediments highly enriched in radionuclides deposited for a long time may be redistributed leading to an enhancement in the most superficial layers of core 2.

In the case of core 3, the layers 4-5 cm and 5-6 cm present values of the Ra-isotopic ratio slightly higher than one (2.04 and 2.12 respectively). However, in the layers above 4 cm the values of this isotopic ratio are typical of uncontaminated sediments. This fact indicates that there is not influence of releases from the phosphate rock processing plants. This result shows the success of the new policy of wastes from the point of view of contamination of water and sediments of Huelva estuary.

Fig. 3 shows the vertical profile of  $^{226}\text{Ra}/^{228}\text{Ra}$  and  $^{137}\text{Cs}$  in core 3, which reflects clearly the history of impact due to the releases of phosphate rock processing plants in sediments of the Huelva estuary. The dates were obtained by assigning the date 1963 to the layer the maximum activity of  $^{137}\text{Cs}$  is obtained in. As can be seen from this figure, the releases of this kind of industrial activity



have led to a clear impact in the sediments of the area. Nevertheless, this impact has been drastically reduced due to the change introduced in the waste policy. Nowadays the values of Ra-isotopic ratios in superficial sediments of the area are typical of uncontaminated sediments.

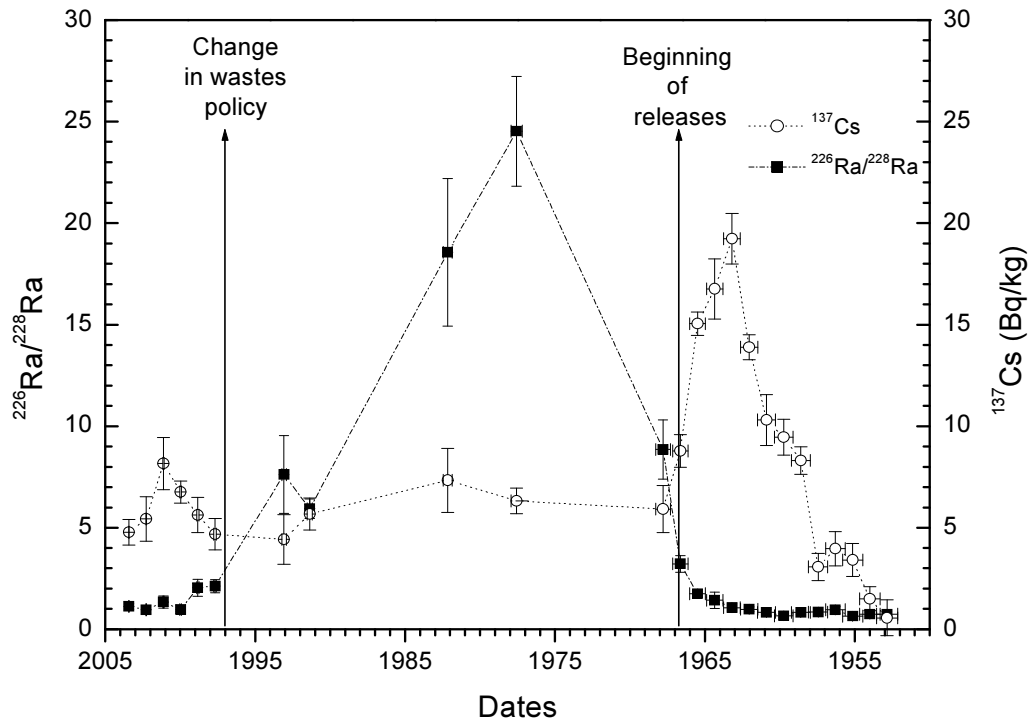

FIG. 3.  $^{226}\text{Ra}/^{228}\text{Ra}$  and  $^{137}\text{Cs}$  vertical profiles in core 3 versus dates

#### 4. Conclusions and general remarks

The vertical profiles of  $^{226}\text{Ra}/^{228}\text{Ra}$  and  $^{230}\text{Th}/^{232}\text{Th}$  activity ratios in sediment cores have been used to delimitate the influence of the wastes from the rock phosphate processing plants in the Huelva estuary. By means of these activity ratios it is possible to evaluate the historical impact of phosphate rock processing plants in sediments of Huelva estuary. The change of the waste policy has been recorded by variations in the values of these isotopic ratios. From the information provided by these activity ratios it is possible to conclude how good the policy waste changes are. The general idea of using this methodology was to characterize the wastes of rock phosphate processing plant, which could be extrapolated to different kinds of NORM industries.

## ACKNOWLEDGMENTS

The authors gratefully acknowledge the collaboration of Dr. J.A. Morales in the sampling campaigns. This work has been supported by the Spanish Department for Science and Technology through the research projects REN2003-04942, CTM2006-08148/MAR, the Spanish Nuclear Council Authority project: "Radiological Impact Produced by Chemical Industries Located in the South of Spain", and the Regional Government of Andalusia.

## REFERENCES

- [1] RUTHERFORD, P.M. et al., Environmental impacts of phosphogypsum: a review, *Sci Total Environ* 149 (1994) 1.
- [2] UNSCEAR. Report of the United Nations Scientific Committee on the Effects of Atomic Radiation, United Nations 2000, New York.
- [3] BOLÍVAR, J.P. et al., On the fractionation of natural radioactivity in the production of phosphoric acid by the wet acid method, *J Radioanal Nucl Chem* 214 (1996) 77.
- [4] BOLÍVAR, J.P. et al., Radiological study of an estuarine system located in the south of Spain. *Water Res* 34 (2000) 2941.
- [5] BOLÍVAR, J.P. et al., Radioactive impact in sediments from an estuarine system affected by industrial waste releases, *Environ Int* 27 (2002) 639.
- [6] BOLÍVAR, J.P. et al., Enhancement of natural radioactivity in soils and salt-marshes surrounding a non-nuclear industrial complex. *Sci Total Environ* 173-173 (1995) 125.
- [7] SAN MIGUEL, E.G. et al., Vertical distribution of Th-isotope ratios,  $^{210}\text{Pb}$ ,  $^{226}\text{Ra}$  and  $^{137}\text{Cs}$  in sediment cores from an estuary affected by anthropogenic releases. *Sci Total Environ* 318 (2004) 143.
- [8] EL-DAOUSHY, F., A summary on the Pb-210 cycle in Nature and related applications in Scandinavia. *Environ Int* 14 (1988) 305.
- [9] PÉREZ-MORENO, J.P. et al., A comprehensive calibration method of Ge detectors for low-level spectrometry measurements. *Nucl Instrum Meth A* 491 (2002) 152.
- [10] HOLM, E., FUKAI, R., Method for multi-element alpha spectrometry of actinides and its application to environmental radioactivity studies. *Talanta* 24 (1977) 659.
- [11] SAN MIGUEL, E.G. et al., Validation of isotope signatures in sediments affected by anthropogenic inputs from uranium series radionuclides. *Environ Pollut* 123 (2003) 125.

## **Modelling NORM in the environment: the EMRAS project**

**R.S. O'Brien<sup>1</sup>, P. Waggitt<sup>2</sup>, T. Zeevaert<sup>3</sup>, D. Pérez Sánchez<sup>4</sup>, V. Koukoulou<sup>5</sup>,  
J. Horyna<sup>6</sup>, E. Quintana<sup>7</sup>, L. Tsatsi<sup>8</sup>, P. McDonald<sup>9</sup>, L. Setlow<sup>10</sup>**

<sup>1</sup> Australian Radiation Protection and Nuclear Safety Agency; Melbourne.

<sup>2</sup> International Atomic Energy Agency; Vienna.

<sup>3</sup> SCK/CEN, Belgium; deceased.

<sup>4</sup> CIEMAT; Madrid.

<sup>5</sup> Greek Atomic Energy Commission; Athens.

<sup>6</sup> State Office for Nuclear Safety; Prague.

<sup>7</sup> Autoridad Regulatoria Nuclear, Buenos Aires.

<sup>8</sup> National Nuclear Regulator; Pretoria.

<sup>9</sup> Westlakes Scientific Consulting Ltd; United Kingdom.

<sup>10</sup> US EPA; Washington, DC.

**Abstract.** Industrial processes such as electricity generation from coal, fertiliser manufacturing and bauxite processing can produce large quantities of residues containing naturally occurring radioactive material (NORM) at significant concentrations. The use of these residues as landfill, construction materials, soil conditioners, etc. can lead to increased exposure for members of the public. This paper describes work carried out as part of the IAEA sponsored project Environmental Modelling for Radiation Safety (EMRAS) which is designed to set up, test and validate models of NORM transport in the environment, especially NORM arising from residue management and disposal. Three hypothetical scenarios for model testing have been developed and are being tested by members of the group. These scenarios are for a point source, an area source, and an area source near a river. Models tested include PC-CREAM, RESRAD ONSITE, RESRAD OFFSITE, COMPLY, CAP-88, DOSDIM, CROM, and the AMBER modelling package. Work is also being carried out to develop a suite of real scenarios with validated data sets for use in model testing. Future possible applications of the results of this work include health impact assessments for both operational sites and legacy sites, and in designing the cleanup of legacy sites in situations where remedial work is required.

### **1. Introduction**

The EMRAS (Environmental Modelling for Radiation Safety) project commenced in November 2004. This project is an International Atomic Energy Agency (IAEA) project that continues some of the work of previous IAEA programmes (BIOMOVS, BIOMASS, and VAMP) in the field of radioecological modelling. EMRAS has focussed on issues such as the consequences of releases of radionuclides to particular types of environment (e.g. urban and aquatic environments), restoration of sites with radioactive residues and impact of environmental radioactivity on non-human species, where uncertainties remain in the predictive capability of environmental models. The main aims of the project are to look at models which might be appropriate, to develop scenarios that can be used for testing models, and to test some of the available models.

Seven working groups were established and continue to operate within the EMRAS programme, with the emphasis on three major themes. The tasks of the different working groups are summarized below:

- Theme 1 - Radioactive release assessment
  - Revision of IAEA Technical Report Series No. 364 [1];
  - Modelling of tritium and carbon-14 transfer to biota and man;
  - The Chernobyl I-131 release: model validation and assessment of the countermeasure effectiveness;

- Working Group 4 - Model validation for radionuclide transport in aquatic systems such as watersheds, rivers and estuaries.
- Theme 2 - Remediation of sites with radioactive residues
  - Modelling of naturally occurring radioactive material (NORM) releases and of the remediation benefits for sites contaminated by extractive industries (uranium/thorium mining and milling, oil and gas industry, phosphate industry, etc);
  - Working Group 2 - Remediation assessment for urban areas contaminated with dispersed radionuclides working group.
- Theme 3 - Protection of the environment
  - Model validation for biota dose assessment

The major aims of the EMRAS programme are to review scientific data, validate existing models by comparing model predictions with data and comparing models against each other, improve models and reduce prediction uncertainties, improve public protection, revise TRS-364, and publish reports. Within this general framework the specific aims of the NORM working group programme can be summarized as:

1. Review the available literature on modelling of NORM in the environment, and compile a bibliography of relevant documents;
2. Compile a list of available models and review the available models;
3. Compile a list of NORM industries;
4. Develop scenarios for testing and comparing models;
5. Make the scenarios available for testing;
6. Test the scenarios using available models and evaluate the results;
7. Prepare reports.

The most urgent task is to develop and evaluate scenarios for model testing and evaluation. The group agreed that this task should be approached by concentrating on generic problems rather than specific problems. The comment was made that one task the group has to carry out is to establish the conditions in which NORM is a problem. One example that was given is the issue of groundwater in old (abandoned) mines.

## **2. Model usage**

The models being assessed and/or developed are intended for use in regulatory assessment, environmental impact assessment, waste/residue management planning, and research.

Models recommended by the group for use in assessing the impact of NORM on human health and the environment need to be easily available, easy to use, well documented, and well tested.

### 3. NORM Industries

Some of the industries that have been considered to date in this work are summarized in Table 1.

TABLE 1. INDUSTRIES THAT GENERATE NORM WASTES AND RESIDUES

	Raw material	Waste(s) and residue(s)	Potential use
Mineral extraction	Uranium ore	Waste rock	Construction
	Mineral sands	Waste rock	Construction
	Coal	Waste rock	Construction
	Copper	Waste rock	Construction
	Bauxite	Waste rock	Construction
Mineral processing	Uranium ore	Tailings	Construction
	Mineral sands	Tailings	Construction
	Copper	Tailings	Construction
	Bauxite	Red mud	Soil conditioning
Phosphate industry	Phosphate rock	Phosphogypsum	Soil conditioning, plasterboard
Oil & gas	Oil, gas	Formation water, scales, sludges, oily sands	
Generation of electricity from coal	Coal	Fly ash, bottom ash	Landfill, road building, cement extender

### 4. Scenarios for model testing

#### 4.1. Hypothetical scenarios

There are a large number of sites where NORM wastes and residues have been disposed of. However, for many of these sites, there are no available data for model testing, or the data that are available are not useful for comprehensive model testing and evaluation. With this in mind three hypothetical scenarios have been developed, with the aim of representing as many real situations as possible. These scenarios are:

- Aa point source,
- An area source, and
- An area source plus a river.

Details of these scenarios can be found in Ref. [2].

#### 4.2. Real Scenarios

Work has begun on the development of a real scenario for a lignite power plant (multiple point sources).

### 5. Models

The models that have been used in this work are listed in Table 2

TABLE 2. MODELS USED TO TEST THE HYPOTHETICAL SCENARIOS

Scenario	Model
Point source	PC-CREAM, CAP-88, COMPLY, CROM
Area source	RESRAD ONSITE, RESRAD OFFSITE, DOSDIM + HYDRUS
Area source + river	RESRAD OFFSITE, DOSDIM + HYDRUS, AMBER modelling package

## 6. Results of model testing

In preliminary testing of the models using the hypothetical scenarios it has been found that, because of the complexity of the models, a large number of parameters need to be specified, and that not all models require the same input data. It has also been found that some data file formats (particularly wind-rose data) are different for different models. This requires flexibility on the part of the modellers and a clear understanding of the requirements of the different models. Some specific results for the different scenarios and models are presented below.

### 6.1. Hypothetical point source scenario

Some results for the hypothetical point source scenario [2] are shown in Figs 1 and 2. The doses predicted by PC-CREAM are at least an order of magnitude higher than those predicted by COMPLY. The reasons for this difference are not understood at the moment.

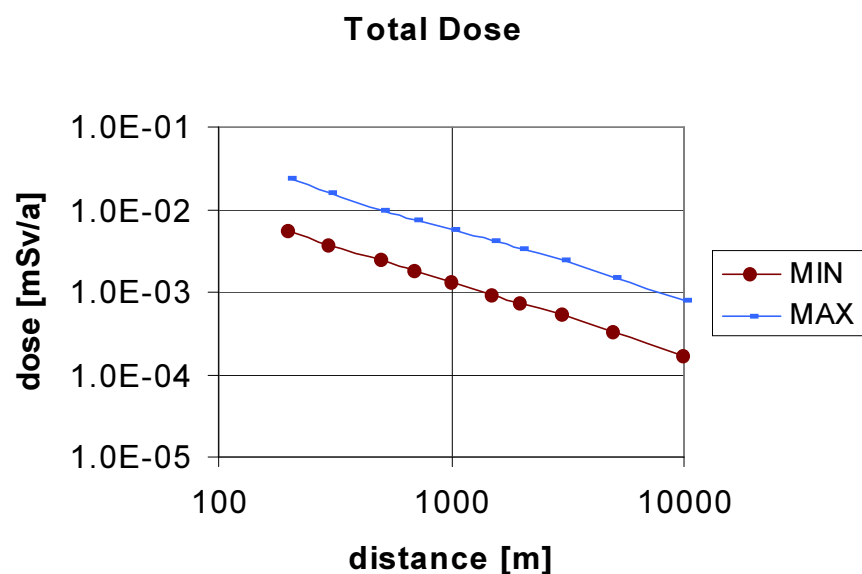

FIG. 1. Total annual dose as a function of distance from the source for the hypothetical point source scenario – calculated using the COMPLY [3] program.

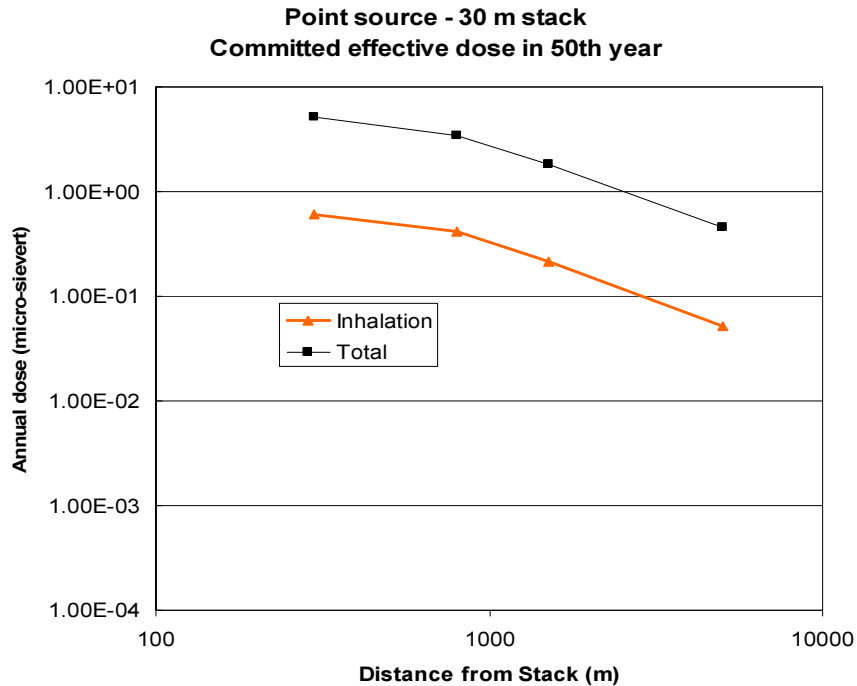

FIG. 2: Total annual dose as a function of distance from the source for the hypothetical point source scenario – calculated using the PC-CREAM [4] package.

### 6.2. Hypothetical area source scenario

The results of some of the model testing for the hypothetical area source scenario [2] are shown in Table 3. In this case the house was situated 500 m from the down gradient edge of the waste (with respect to the direction of groundwater flow). The waste was 1 km by 1 km in area and 10 m deep with 2 m of cover (in the covered case), on top of a 3 m unsaturated layer of 80% sand and 20% clay. The unsaturated layer was underlain by a 15 m thick aquifer. The radionuclide concentrations specified were 100 Bq g<sup>-1</sup> of uranium-238 in secular equilibrium with its decay products. Again there appear to be significant differences between the total doses predicted by the two models. The reasons for these differences are not understood at this time.

TABLE 3. DOSE RECEIVED BY A RESIDENT NEAR A NORM WASTE SITE (Sv a<sup>-1</sup>)

Time (a)	Uncovered waste		Covered waste	
	DOSDIM	RESRAD	DOSDIM	RESRAD
1	2.0×10 <sup>-4</sup>	8.4×10 <sup>-3</sup>	1.5×10 <sup>-6</sup>	7.5×10 <sup>-4</sup>
10	2.0×10 <sup>-4</sup>	200×10 <sup>-3</sup>	1.5×10 <sup>-6</sup>	7.6×10 <sup>-4</sup>
100	2.0×10 <sup>-4</sup>	350×10 <sup>-3</sup>	1.5×10 <sup>-6</sup>	7.8×10 <sup>-4</sup>
1000	2.0×10 <sup>-4</sup>	124×10 <sup>-3</sup>	1.6×10 <sup>-6</sup>	2.1×10 <sup>-4</sup>
5000	2.0×10 <sup>-4</sup>	60×10 <sup>-3</sup>	2.1×10 <sup>-6</sup>	10.3×10 <sup>-4</sup>
10 000	2.0×10 <sup>-4</sup>	32×10 <sup>-3</sup>	2.9×10 <sup>-6</sup>	9.9×10 <sup>-4</sup>

### 7. Summary and conclusions

The three hypothetical scenarios have been tested using several different models. In general the results from different models are similar, but the differences that do exist need to be examined in more detail.

The work so far has shown that there is a need to consider ways of standardizing data file formats. It is acknowledged that this is a difficult issue to resolve, because of the different ways in which these formats have been developed, and the uses (quite different from this project) that are currently made of these data files.

None of the models tested so far specifically addresses the issue of the long radioactive decay chains that are unique to the study of NORM. This has some interesting consequences. In principle the models used with the area source scenario should be able to be “calibrated” by using these models to predict the “natural background” dose. However, some of the radionuclides (for example bismuth-214) that make a significant contribution to the natural background dose are not included in the models because these radionuclides have relatively short radioactive half-lives. Care has to be taken to include the dose contribution from these radionuclides in the dose attributed to the relatively long-lived “parent” nuclide; it is not always clear that this is the case.

The results reported here are preliminary and may change as the scenarios are refined and further developed using feedback from the model testing.

There appear to be significant differences between the predictions from different models for both the hypothetical point source scenario and the hypothetical area source scenario. Further work is needed to resolve these differences.

#### REFERENCES

- [1] INTERNATIONAL ATOMIC ENERGY AGENCY, Handbook of Parameter Values for the Prediction of Radionuclide Transfer in Temperate Environments, Technical Reports Series No. 364, IAEA, Vienna (1994).
- [2] <http://www-ns.iaea.org/projects/emras/emras-norm-wg.htm>
- [3] <http://www.epa.gov/radiation/assessment/comply.html>
- [4] SIMMONDS, J.R., LAWSON, G., MAYALL, A., Methodology for assessing the consequences of routine releases of radionuclides to the environment, Rep. EUR 15670, European Commission, Luxembourg (1995).
- [5] SIMUNEK, J., VAN GENUCHTEN, M.T., SEJNA, M., The HYDRUS-1D Software Package for simulating the one-dimensional movement of water, heat and multiple solutes in variably-saturated media, Version 3.0, HYDRUS Software Series 1, Department of Environmental Sciences, University of California Riverside, Riverside, CA (2005).
- [6] YU, C., LOUREIRO, C., CHENG, J.-J., JONES, L.G., WANG, Y.Y., CHIA, Y.P., FAILLACE, E., Data Collection Handbook to Support Modelling Impacts of Radioactive Material in Soil, Environmental Assessment and Information Sciences Division, Argonne National Laboratory, Argonne, IL (1993).
- [7] User’s Guide for RESRAD-OFFSITE Version 2.0. Draft only, 2006.



## Dicalcium phosphate: content of uranium decay series

N. Casacuberta<sup>1</sup>, P. Masqué<sup>1</sup>, J. García-Orellana<sup>1</sup>, J.M. Bruach-Menchén<sup>1</sup>,  
J.A. Sanchez-Cabeza<sup>2</sup>, M. Villa<sup>3</sup>, S. Hurtado<sup>3</sup>, G. Manjón<sup>3</sup>, R. Garcia-Tenorio<sup>3</sup>

<sup>1</sup> Institut de Ciència i Tecnologia Ambientals  
Departament de Física, Universitat Autònoma de Barcelona  
08193 Bellaterra, Spain.

<sup>2</sup> International Atomic Energy Agency, Marine Environment Laboratory  
MC-98000, Monaco.

<sup>3</sup> Servicio de Radioisótopos, CITIUS, Universidad de Sevilla  
Avda Reina Mercedes s/n, 41012 Sevilla, Spain.

**Abstract:** Poultry livestock feed supplements and some products for human consumption contain a small percentage (1-2%) of dicalcium phosphate (DCP), this usually produced from phosphate rocks. Depending on the origin of the phosphate rocks and the industrial process, DCP may contain significant amounts of <sup>238</sup>U and some of its decay chain daughters. Since ingestion is the most effective pathway of entry of radionuclides in organisms, we have investigated the presence of the <sup>238</sup>U decay series in a batch of 12 samples of DCP produced for livestock feed supplements and commercialised in Catalonia (Spain). In addition, 4 DCP samples for human consumption have also been analysed. For all samples, replicate materials corresponding to different lots were analysed. Uranium isotopes and <sup>210</sup>Po were quantified by alpha spectrometry after radiochemical purification. Gamma spectrometry was used to determine the concentrations of relevant gamma emitters present in the samples (i.e. <sup>210</sup>Pb, <sup>226</sup>Ra, <sup>230</sup>Th, <sup>234</sup>Th and other isotopes such as <sup>40</sup>K). Results show that all DCP samples produced for animal feeding contain significant concentrations (approximately 10<sup>3</sup> Bq/kg) of <sup>238</sup>U, <sup>234</sup>U and <sup>234</sup>Th. Presence of the rest of the <sup>238</sup>U decay daughters show a different pattern: for instance, concentrations of <sup>230</sup>Th are inversely correlated with those of <sup>210</sup>Pb and <sup>210</sup>Po. <sup>226</sup>Ra concentrations barely exceed 10<sup>2</sup> Bq·kg<sup>-1</sup> but, indeed, highest levels correspond to samples with high (ca. 10<sup>3</sup> Bq/kg) contents of <sup>210</sup>Pb and <sup>210</sup>Po. It is noteworthy that none of the DCP samples for human consumption present significant concentrations (always < 20 Bq/kg) of the investigated radionuclides. Interpretation of the data is done taking into account the nature of the phosphate rocks, the regions of origin and the industrial process of production of the DCP materials.

### 1. Introduction

Phosphate rock is used as a source of phosphorous for the production of either fertilizers or feed supplements for both domestic animals and humans: dicalcium phosphate (DCP). However, sedimentary phosphate ores such as those placed in Florida and Morocco, contain high concentrations of <sup>238</sup>U (1500-1700 Bq/kg) [1] and its decay chain daughters, whereas magmatic ores, such as apatite from Kola (Russia), are characterized by lower concentrations (30-200 Bq/kg) [2]. That is related to the fact that rocks of sedimentary origin are formed by the adsorption and co-precipitation of uranium with calcium [3]. Fluoroapatite, the main component of phosphate rock is very insoluble in its original chemical state and it can not be used as a source of phosphorous in this form [4]. Therefore a chemical treatment of the rock is required, and a digestion of the milled rock is done by using either sulphuric acid, hydrochloric acid or nitric acid. Then CaCO<sub>3</sub> is added to adjust the pH to ~2, and the DCP is precipitated from solution and separated by vacuum filtration [5].

Although different manufacturing processes are used for the production of dicalcium phosphate, it is well documented that the use of phosphate rock of sedimentary origin as a raw material will produce the addition of certain amounts of isotopes from the <sup>238</sup>U decay series [5]. During the reaction of phosphate rock with sulphuric acid (1) radium co-precipitates with CaSO<sub>4</sub>, while uranium and thorium follow the phosphorous into the acid, which is then used for the manufacture of other products such as dicalcium phosphate as a poultry livestock feed supplement [1].



The objective of this study was to investigate the presence of the  $^{238}\text{U}$  decay series in representative samples of DCP for livestock feed supplements commercialised in Catalonia (Spain) in 2006. In addition, 4 samples of DCP produced for human consumption were also analysed. All samples were known to be manufactured from phosphate rock from either Morocco or Israel (Negev desert), both having an original activity concentration in  $^{238}\text{U}$  of 1500-1700 Bq/kg [1].

## 2. Materials and methods

16 samples of DCP commercialized in Catalonia (Spain) during the first semester of 2006 were provided by the *Agència Catalana de Seguretat Alimentària* of the Department of Health of the Government of Catalonia for analysis. Two replicates of each sample type were analysed.

Gamma emitters such as  $^{226}\text{Ra}$ ,  $^{212}\text{Bi}$ ,  $^{231}\text{Pa}$ ,  $^{230}\text{Th}$  and  $^{232}\text{Th}$ , as well as  $^{60}\text{Co}$ ,  $^{137}\text{Cs}$  and  $^{40}\text{K}$  were quantified by gamma spectrometry. Between 500 and 1000 g of sample was placed into a Marinelli geometry. Samples were measured for 80 000–150 000 s by using a coaxial HPGe detector, according to standard methods. Uranium isotopes and  $^{210}\text{Po}$  were quantified by alpha spectrometry after radiochemical purification. For the quantification of  $^{210}\text{Po}$  activity, between 150 and 250 mg of DCP were digested, after being spiked with 100  $\mu\text{L}$  of  $^{209}\text{Po}$  tracer, with HCl,  $\text{HNO}_3$  and HF, using a microwave [6]. Boric acid ( $\text{H}_3\text{BO}_3$ ) was added in order to remove the fluorides. After digestion and evaporation, the residue was dissolved in 100  $\text{cm}^3$  1M HCl. After the addition of ascorbic acid to reduce the Fe (III),  $^{210}\text{Po}$  was plated out on a stainless steel disc. Plating time was approximately 6–7 h at 70°C with constant stirring. For the quantification of  $^{238}\text{U}$  and  $^{234}\text{U}$ , anionic exchange columns were used to allow uranium and thorium separation.

## 3. Results

We grouped the samples according to manufacturing processes used to obtain DCP, as shown in Table I (Groups A and B). Also, samples for human consumption are coded as Group C. The synthesis of the concentrations of the relevant radionuclides in all analysed samples of DCP for both human consumption and poultry livestock feed supplements is given in Table II.

TABLE I. SAMPLE DESCRIPTION

Group	Sample code	DCP food supplement	Rock	Origin	Phosphoric acid origin
A	#1, #2, #3, #4, #9, #10	Animal	Phosphate rock	Morocco	-
B	# 5, #6	Animal	Sedimentary phosphate rock	Morocco (Boucraa)	Huelva (Spain)
	#7, #8	Animal	Sedimentary phosphate rock	Negev Desert	Turkey
	#11, #12	Animal	-	-	Liban
C	#sha-1	Human	-	-	Prayon
	#sha-2	Human	-	-	Rhodia
	#sha-3	Human	-	-	Haifa Chemical Ltd.
	#sha-4	Human	-	-	Budenheim

TABLE II. ACTIVITY CONCENTRATIONS OF NATURAL AND ARTIFICIAL RADIONUCLIDES (Bq/kg)

<i><sup>40</sup>K and artificial isotopes</i>						
Group	<sup>40</sup> K	<sup>137</sup> Cs	<sup>60</sup> Co	<sup>241</sup> Am		
A (n=12)	<5.47 <sup>a</sup>	<0.53 <sup>a</sup>	<0.45 <sup>a</sup>	<0.86 <sup>a</sup>		
B (n=12)	28 ± 14	<0.44 <sup>a</sup>	<0.36 <sup>a</sup>	<0.75 <sup>a</sup>		
C (n=4)	<9.3 <sup>a</sup>	<0.67 <sup>a</sup>	<0.6 <sup>a</sup>	<0.47 <sup>a</sup>		
<i><sup>238</sup>U decay chain</i>						
Group	<sup>238</sup> U <sup>b</sup>	<sup>234</sup> Th	<sup>234</sup> U <sup>b</sup>	<sup>230</sup> Th	<sup>226</sup> Ra ( <sup>214</sup> Pb)	<sup>210</sup> Pb
A (n=12)	1138 ± 109	909 ± 79	906 ± 97	<93 <sup>a</sup>	96 ± 22	1297 ± 124
B (n=12)	1046 ± 17	923 ± 156 <sup>c</sup>	943 ± 15	1007 ± 830 <sup>c</sup>	13 ± 5	<3–29.2 <sup>d</sup>
C (n=4)	20 ± 7	<5.2 <sup>a</sup>	19 ± 5	<46 <sup>a</sup>	7 ± 6	<3.7 <sup>a</sup>
<i><sup>232</sup>Th and <sup>235</sup>U decay chains</i>						
Group	<sup>232</sup> Th	<sup>228</sup> Ra ( <sup>228</sup> Ac)	<sup>212</sup> Bi	<sup>235</sup> U <sup>b</sup>	<sup>231</sup> Pa	
A (n=12)	<157 <sup>a</sup>	1.7 ± 0.4	<3.3 <sup>a</sup>	47 ± 4	<24 <sup>a</sup>	
B (n=12)	<148 <sup>a</sup>	<1.3 <sup>a</sup>	5 ± 2	49 ± 1	111 ± 50	
C (n=4)	<86 <sup>a</sup>	<2.2 <sup>a</sup>	<5.0 <sup>a</sup>	0.8 ± 0.3	<31 <sup>a</sup>	

<sup>a</sup> Reported values correspond to the average of individual MDA.

<sup>b</sup> Number of samples analysed for U isotopes by alpha spectrometry were n=6 (A), n=1 (B), n=2 (C).

<sup>c</sup> Excluding sample #8, for which concentrations of <sup>234</sup>Th and <sup>230</sup>Th were 2236 ± 12 Bq/kg (n=2) and 2488 ± 256 Bq/kg (n=2).

<sup>d</sup> The range of activities include samples for which only the MDA was determined. For sample #12 concentrations were 100 ± 41 Bq/kg and 121 ± 35 Bq/kg for <sup>210</sup>Pb and <sup>210</sup>Po respectively.

### **3.1. DCP for poultry livestock feed supplement**

U-238 activities varied between  $999 \pm 16$  and  $1257 \pm 20$  Bq/kg, with a mean value of  $1125 \pm 106$  Bq/kg.  $^{234}\text{U}$  had an activity range from 784 to 1032 Bq/kg, with an average of  $911 \pm 89$  Bq/kg.

Th-234 was also present in all samples and had concentrations between  $688 \pm 7$  and  $1161 \pm 10$  Bq/kg, with the exception of sample #8, this one having a concentration of  $2200 \pm 20$  Bq/kg. Excluding this sample, average concentrations were  $915 \pm 117$  Bq/kg. Its presence might be attributed to  $^{238}\text{U}$  decay, although the secular equilibrium was still not reached when quantification of the samples.

Th-230 activities might be gathered together in three different groups. The first one, with samples #1, #2, #3, #4, #9 and #10 with activities below the detection limit for this technique, 100 Bq/kg (MDA). The second group, consisting of samples #11 and #12, with mean activities of  $238 \pm 75$  and  $63 \pm 2$  Bq/kg respectively (the MDA in this case was 65 Bq/kg). For the third group, with samples #5, #6, #7 and #8, activities were around 1000 Bq/kg, with the exception of sample #8, with a concentration of  $2500 \pm 200$  Bq/kg.

Ra-226 activity (analysed via the  $^{214}\text{Pb}$  photopeak at 351.9 keV) had an inverse activity distribution respect to  $^{230}\text{Th}$ , although none of the samples exceeded 150 Bq/kg. The first group having a mean activity of  $96 \pm 21$  Bq/kg and the second group, which corresponds to highest activities of  $^{230}\text{Th}$  had a mean activity of  $13 \pm 5$  Bq/kg.

Pb-210 and  $^{210}\text{Po}$  activities could also be set into two different groups. Mean activities for samples #1, #2, #3, #4, #9 and #10 were  $1297 \pm 124$  and  $985 \pm 219$  Bq/kg, respectively. The rest of the samples had concentrations of about 20-30 Bq/kg or lower, with the exception of sample #12, with 100 and 120 Bq/kg of  $^{210}\text{Pb}$  and  $^{210}\text{Po}$ , respectively. From the information on production dates for each sample, between 6 and 9 months lapsed until analyses. Therefore, a significant fraction of  $^{210}\text{Po}$  may be derived from  $^{210}\text{Pb}$  decay, although the extent of this cannot be more precisely determined.

Regarding the  $^{232}\text{Th}$  decay chain, no significant elevated activities were determined. Indeed,  $^{232}\text{Th}$  activity was below the detection limit for the gamma technique (which is noteworthy to say that the detection limits used are relatively high,  $\sim 150$  Bq/kg). Still, the radiological risk for ingestion of this radionuclide is low. Activities for  $^{228}\text{Ra}$  ( $^{228}\text{Ac}$ ) varied between 1.2 and 2.5 Bq/kg and between 2.4 and 9.1 Bq/kg for  $^{212}\text{Bi}$ . Samples with presence of  $^{212}\text{Bi}$  were the ones which its production came from the phosphoric acid precipitation.

U-235 had a mean activity of  $47 \pm 4$  Bq/kg ( $n=7$ ).  $^{231}\text{Pa}$  showed values of about 100-200 Bq/kg for samples #5, #6, #7 and #8, which correspond to those that came from the manufacture of phosphoric acid. The DCP samples obtained from the digestion of phosphate rock present values below the detection limit (30 Bq/kg).

K-40 presented maximum values of 60 Bq/kg (sample #8), between 20 and 30 Bq/kg for samples #5, #6, #7, #11 and #12 and less than 10 Bq/kg for the rest of materials. Again, DCP samples obtained from phosphoric acid, presented more elevated activities.

All artificial radioisotopes ( $^{60}\text{Co}$ ,  $^{137}\text{Cs}$  and  $^{241}\text{Am}$ ) had activities lower than the detection limit for this technique (1 Bq/kg).

### **3.2. DCP for human consumption**

All radioisotopes in samples of DCP for human consumption are characterized by low values. Activities of  $^{238}\text{U}$ ,  $^{234}\text{U}$ ,  $^{234}\text{Th}$  and  $^{226}\text{Ra}$  were below 25 Bq/kg,  $^{230}\text{Th}$  is below the detection limits for this technique and  $^{210}\text{Pb}$  and  $^{210}\text{Po}$  did not exceed 10 Bq/kg. Regarding  $^{232}\text{Th}$  and  $^{235}\text{U}$  chains,  $^{232}\text{Th}$ ,  $^{228}\text{Ra}$ ,  $^{212}\text{Bi}$  and  $^{231}\text{Pa}$  are also below the detection limits, whereas it did not exceed 1 Bq/kg for  $^{235}\text{U}$ . Specific activities for  $^{40}\text{K}$  were below 10 Bq/kg. As for artificial radionuclides, namely  $^{60}\text{Co}$ ,  $^{137}\text{Cs}$  and  $^{241}\text{Am}$ , concentrations were below 1 Bq/kg.

#### 4. Discussion

DCP samples for human consumption do not present significant concentrations (less than 20 Bq·kg<sup>-1</sup> as a maximum) of the investigated radionuclides. All samples produced for animal feeding contain significant concentrations (approximately 10<sup>3</sup> Bq/kg) of <sup>238</sup>U, <sup>234</sup>U and <sup>234</sup>Th. Presence of the rest of the <sup>238</sup>U decay daughters show a different pattern: for instance, concentrations of <sup>230</sup>Th are inversely correlated with those of <sup>210</sup>Pb and <sup>210</sup>Po. The explanation relies on the fact that two different processes are used for the production of DCP; either by digesting calcined phosphate rock or by mixing phosphoric acid with an appropriate material, such as lime or soda ash [7]. <sup>226</sup>Ra concentrations barely exceed 10<sup>2</sup> Bq/kg but, indeed, highest levels correspond to samples with high (ca. 10<sup>3</sup> Bq/kg) contents of <sup>210</sup>Pb and <sup>210</sup>Po. The lack of equilibrium between <sup>238</sup>U and <sup>226</sup>Ra is due to the chemical separation of both in the digestion of phosphate rock, where <sup>226</sup>Ra goes predominantly to phosphogypsum [8]. Pb-210 and <sup>210</sup>Po are not in secular equilibrium with <sup>226</sup>Ra; neither <sup>210</sup>Po is in secular equilibrium with <sup>210</sup>Pb (with the exception of sample #3). As much of a 30% of <sup>210</sup>Po might co-precipitate with the DCP [5] during production. However, since half-life of <sup>210</sup>Po is 138.4 days, a significant fraction of the measured <sup>210</sup>Po in our samples may come from the <sup>210</sup>Pb decay. It is noticed that <sup>210</sup>Pb is in equilibrium with <sup>238</sup>U, which it does not agree with other works (i.e. [9], [5] and [10]). This fact may be due to the diverse acid digestion processes of the phosphoric rock and the first steps of manufacturing, which is being investigated in ongoing research.

#### REFERENCES

- [1] UNITED NATIONS, Exposures from Natural Sources of Radiation. Annex A, Scientific Committee on the Effects of Atomic Radiation (UNSCEAR), UN, New York (1982).
- [2] STRADEN, E., Sources of exposure to technologically enhanced natural radiation, *Sci. Total Environ.* **45** (1985) 27–45.
- [3] KHATER, A.E.M., HIGGY, R.H., PIMPL, M., Radiological impacts of natural radioactivity in Abu-Tartor phosphate deposits, Egypt, *J. Environ. Radioactivity* **55** (2001) 255–267.
- [4] ROMERO GUZMÁN, E.T., SOLACHE RÍOS, M., ITURBE GARCÍA, J.L., ORDOÑEZ REGIL, E., Uranium in phosphate rock and derivatives *J. Radioanalyt. Nucl. Chem. Articles* **189** 2 (1995) 301–306.
- [5] GÄFVERT, T., HOLM, E., ROOS, P., Radionuclide fluxes at a plant manufacturing dicalcium phosphate for domestic animals, *J Environ. Radioactivity* **54** (2001) 61–73.
- [6] SANCHEZ-CABEZA, J.A., MASQUÉ, P., ANI-RAGOLTA, I., <sup>210</sup>Pb and <sup>210</sup>Po analysis in sediments and soils by microwave acid digestion, *J. Radioanalyt. Nucl. Chem.* **227** (1998) 19–22.
- [7] REID, D.F., SACKETT, W.M., SPALDING, R.F., Uranium and radium in livestock feed supplements, *Health Phys.* **32** (1977) 535–540.
- [8] UNITED NATIONS, Exposures from Natural Sources of Radiation, Annex A, Scientific Committee on the Effects of Atomic Radiation (UNSCEAR), UN, New York (1988).
- [9] MAS, J.L., SAN MIGUEL, E.G., BOLÍVAR, J.P., VACA, F., PÉREZ-MORENO, J.P., An assay on the effect of preliminary restoration tasks applied to a large TENORM wastes disposal in the south-west of Spain, *Sci. Total Environ.* **364** (2006) 55–66.
- [10] SANTOS, A.J.G., MAZZILLI, B.P., FÁVARO, D.I.T., SILVA, P.S.C., Partitioning of radionuclides and trace elements in phosphogypsum and its source materials based on sequential extraction methods, *J. Environ. Radioactivity* **87** (2006) 52–61.



# Sequential determination of U and Th isotopes and $^{226}\text{Ra}$ by alpha spectrometry in phosphate fertilizer samples and phosphogypsum

C.H.R. Saueia<sup>a</sup>, B.P. Mazzilli<sup>a</sup>, M.H.T. Taddei<sup>b</sup>

<sup>a</sup> Laboratório de Radiometria Ambiental  
Instituto de Pesquisas Energéticas e Nucleares  
Av. Prof. Lineu Prestes 2242, CEP 05508-900, São Paulo, Brazil  
Email: [mazzilli@ipen.br](mailto:mazzilli@ipen.br)

<sup>b</sup> Laboratório de Poços de Caldas, Comissão Nacional de Energia Nuclear, Brazil

**Abstract.** The Brazilian phosphate fertilizer is obtained by wet reaction of igneous phosphate rock with concentrated sulphuric acid, giving as final product phosphoric acid and calcium sulphate (phosphogypsum) as by-product. Phosphoric acid is the starting material for the production of the majors' phosphate fertilizers: triple superphosphate (TSP), single superphosphate (SSP), monoammonium phosphate (MAP) and diammonium phosphate (DAP). The phosphate rock used as raw material is enriched in radionuclides of the U and Th natural series. During the chemical attack these radionuclides are distributed among products and by-products. A sequential procedure was implemented to determine the content of radionuclides alpha emitters ( $^{234}\text{U}$ ,  $^{238}\text{U}$ ,  $^{230}\text{Th}$ ,  $^{232}\text{Th}$ ,  $^{228}\text{Th}$  and  $^{226}\text{Ra}$ ) in samples of phosphate rock, phosphogypsum and phosphate fertilizers produced by the Brazilian industries. The experimental procedure consisted of a chemical attack with strong acids, followed by sequential chromatography extractions in column with ionic resins. Depending upon the conditions of percolation U isotopes are separated, followed by Th isotopes and  $^{226}\text{Ra}$ . The solutions containing U and Th are electroplated on stainless steel disks and counted on a surface barrier detector for alpha spectrometry. To the Ra final solution, a  $\text{BaSO}_4$  seeding suspension was added to allow the formation of a micro precipitated of  $\text{BaRaSO}_4$ . This precipitate is filtered in a polypropylene membrane and counted on the same detector. The precision and accuracy of the method were determined by analyzing reference materials: soil IAEA-326 and sediment IAEA-300. SSP and TSP, which are obtained by reacting phosphoric acid with phosphate rock in different proportions, presented higher concentrations of all studied radionuclides. Brazilian phosphate fertilizers, which are produced directly from phosphoric acid, MAP and DAP, present in their composition low concentrations of radionuclide  $^{226}\text{Ra}$ . As for the radionuclides U and Th, the concentrations observed are higher.

## 1. Introduction

Uranium is known to be present in association with phosphate deposits of marine origin. Consequently, the various radionuclides of the natural occurring uranium decay series would be expected to be present with this mineral and to be partitioned by physical and chemical means during phosphate mining and subsequent processing. Several groups of researchers throughout the world have reported the distribution of natural radioactivity concentrations in the products, by-products and waste from the chemical process [1-5]. In Brazil, the phosphate rock used as raw material for phosphoric acid production is an igneous rock (phoscorite) made up of apatite, magnetite and olivine and cut by abundant carbonatitic veins. This rock is associated with uranium, thorium and their decay products. The Brazilian phosphate fertilizer is obtained by wet reaction of this igneous phosphate rock with concentrated sulphuric acid, giving as final product phosphoric acid and calcium sulphate (phosphogypsum) as by-product. Phosphoric acid is the starting material for the production of the majors' phosphate fertilizers: triple superphosphate (TSP), single superphosphate (SSP), monoammonium phosphate (MAP) and diammonium phosphate (DAP). Although several publications were found related with the characterization of Brazilian phosphate rock and phosphogypsum [6-9], no specific reference was found concerning the radiological characterization of the Brazilian phosphate fertilizers.

The present paper deals with the implementation of a sequential procedure to determine the content of radionuclides alpha emitters ( $^{234}\text{U}$ ,  $^{238}\text{U}$ ,  $^{230}\text{Th}$ ,  $^{232}\text{Th}$ ,  $^{228}\text{Th}$  and  $^{226}\text{Ra}$ ) in samples of phosphate rock, phosphogypsum and phosphate fertilizers produced by the Brazilian industries. The investigation was directed specifically at identification of optimum conditions necessary for complete sample dissolution,

for efficient separation of radium, thorium and uranium isotopes from all other components of the sample, and for preparing the final barium-radium fraction and Th and U electroplated for alpha spectrometry. The experimental procedure adopted is a combination of the methodology proposed by Ref. [10] for the determination of Ra by alpha spectrometry after a micro precipitation of Ra with barium sulphate in the presence of a seeding suspension; and of a methodology already established by the authors for the determination of Th and U isotopes electroplated by alpha spectrometry [11].

## 2. Experimental

Analysis was carried out on samples of phosphate rock (12), phosphogypsum (8) and fertilizers (18), obtained from the three main Brazilian factories, named A, B and C. After collection, the samples were dried at about 60°C to remove moisture and crushed to fine powder (30 to 60 mesh). The radiochemical procedure was based on the total dissolution of 250 mg of the samples, by addition of concentrated acids under heating at 80°C, in the presence of exact aliquots of  $^{133}\text{Ba}$ ,  $^{232}\text{U}$  and  $^{229}\text{Th}$  tracers. A volume of 10 mL of concentrated  $\text{HNO}_3$  was added to the sample and the solution was evaporated carefully to near dryness. The residue was treated with 1 mL  $\text{H}_2\text{O}_2$  to eliminate organic matter and with concentrated HF to eliminate silica. The final solution was conditioned with concentrated HCl to eliminate nitrates and the elements of interest separated and purified by sequential chromatography extractions in column with DOWEX 1x8 ionic resins. In the first column the solution is eluted in a Dowex 1x 8 resin in 9M HCl: U is retained whereas Th isotopes and Ra flow through the resin. U is eluted with 0,1M HCl and the final solution electroplated on a disk for alpha counting. The eluate containing Th and Ra is passed through two columns: the first one (Dowex 1x8 resin in 8M  $\text{HNO}_3$ ) for the retention of Th and the second one (Dowex 1x8 resin in 0,75M HBr) for the purification of Ra. Th is eluted with 9M HCl and is electroplated for alpha counting. A seeding suspension of  $\text{BaSO}_4$  is added to the solution containing Ra; the  $\text{BaRaSO}_4$  micro precipitated formed is retained in a Polypropylene membrane filter and counted on the alpha spectrometer for the determination of  $^{226}\text{Ra}$ . For the determination of the chemical yield the same precipitate is counted on a germanium detector for the determination of  $^{133}\text{Ba}$ . All the alpha measurements were performed on a surface barrier detector, EG&G Ortec. The precision *and* accuracy of the method were determined by analyzing reference materials: soil IAEA-326 *and* sediment IAEA-300. The precision achieved was 6.7% for U isotopes, 7.9 % for Th isotopes *and* 4.7 % for  $^{226}\text{Ra}$ ; the accuracy obtained was 5.4 %, 7.6 % *and* 4.4 % respectively. Typical lower limits of detection for the alpha measurement of the radionuclides were 1.4 mBq  $\text{kg}^{-1}$  for  $^{238}\text{U}$ , 1.3 mBq  $\text{kg}^{-1}$  for  $^{234}\text{U}$ , 0.9 mBq  $\text{kg}^{-1}$  for  $^{230}\text{Th}$ , 0.8 mBq  $\text{kg}^{-1}$  for  $^{226}\text{Ra}$ , 1.0 mBq  $\text{kg}^{-1}$  for  $^{232}\text{Th}$  and 1.0 mBq  $\text{kg}^{-1}$  for  $^{228}\text{Th}$ , respectively.

## 3. Results and discussion

Results obtained for the radionuclides,  $^{238}\text{U}$ ,  $^{234}\text{U}$ ,  $^{230}\text{Th}$ ,  $^{226}\text{Ra}$ ,  $^{232}\text{Th}$  and  $^{228}\text{Th}$  on samples of phosphate rock, phosphogypsum and fertilizers (TSP, SSP, MAP and DAP) obtained from the Brazilian three main factories, named A, B and C, are presented in Fig. 1.

Brazilian phosphate fertilizers, which are produced directly from phosphoric acid, MAP and DAP, present in their composition low concentrations of radionuclides  $^{226}\text{Ra}$ . As for the radionuclides U and Th, the concentrations observed are higher, reaching values up to 822 and 850 Bq  $\text{kg}^{-1}$ , respectively. SSP and TSP, which are obtained by reacting phosphoric acid with phosphate rock in different proportions, presented higher concentrations of all studied radionuclides, reaching values up to 1158 Bq  $\text{kg}^{-1}$  for  $^{238}\text{U}$ , 1167 Bq  $\text{kg}^{-1}$  for  $^{234}\text{U}$ , 1169 Bq  $\text{kg}^{-1}$  for  $^{230}\text{Th}$ , 879 Bq  $\text{kg}^{-1}$  for  $^{226}\text{Ra}$ , 521 Bq  $\text{kg}^{-1}$  for  $^{232}\text{Th}$ , and 302 Bq  $\text{kg}^{-1}$  for  $^{228}\text{Th}$ . The results obtained show that the levels of radioactivity present in the fertilizers are of the same order of magnitude of those found in the phosphogypsum. Whereas, the fertilizers are commercialized, providing a dilution of their content of radioactivity, the phosphogypsum is storage in piles at open air, posing serious problems to the surrounding environment. One of the main problems is the levels of impurities, including radioactivity, which prevent its reutilization, although it presents the same radioactivity content as the fertilizers. It should be emphasized that it is a common practice in



environmental radioprotection to minimize the effect of a punctual contamination to dilute spatially and temporally the source in order to reduce the environmental impact. The phosphogypsum piles are a typical example of such situation, since the radiological impact caused to the environment in the surrounding area is certainly more relevant than those caused by its reutilization.

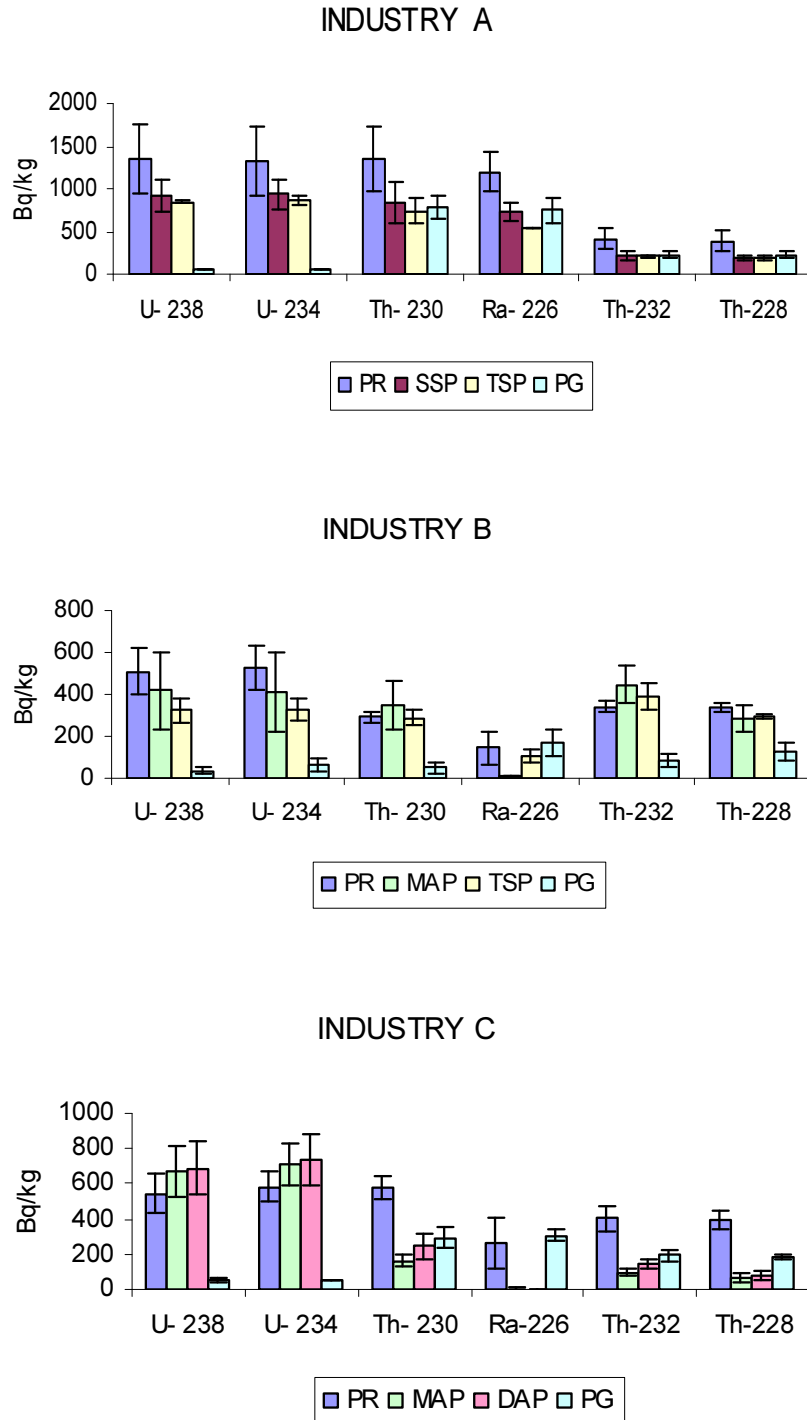

FIG. 1. Activity concentration of radionuclides of the U and Th series and  $^{226}\text{Ra}$  in samples of phosphate rock (PR), phosphogypsum (PG) and phosphate fertilizers (SSP, TSP, MAP, DAP) in  $\text{Bq kg}^{-1}$

## ACKNOWLEDGMENTS

This work was supported by Conselho Nacional de Desenvolvimento Científico e Tecnológico – CNPq, grant 300835/95-7 and 141792/01-9, and Fundação de Amparo à Pesquisa do Estado de São Paulo - FAPESP, research contract 1997/1597-6.

## REFERENCES

- [1] ROESSLER, C.E., SMITH, Z.A., BOLCH, W.E., PRINCE, R.J., Uranium and radium-226 in Florida phosphate materials, *Health Phys.* **37** (1979) 269–277.
- [2] ALAM, M.N., CHOWDHURY, M.I., KAMAL, M., GHOSE, S., HAMIDA, B., CHAKRABORTY, D, Radioactivity in chemical fertilizers used in Bangladesh, *Appl. Radiat. Isot.* **48** (1997) 1165–1168.
- [3] HAMANO, H., LANDSBERGER, S., HARBOTTLE, G., PANNO, S., Studies of radioactivity and heavy metals in phosphate fertilizer, *J. Radioanal. Nucl. Chem.* **194** (1995) 331–336.
- [4] AZOUAZI, M., OUAHIDI, Y., FAKHI, S., ANDRES, Y., ABBE, J.C., BENMANSOUR, M., Natural radioactivity in phosphates, phosphogypsum and natural waters in Morocco, *J. Environ. Radioactivity* **54** (2001) 231–242.
- [5] KHAN, K., KHAN, H.M., TUFAIL, M., KHATIBEH, A.J.A.H., AHMAD, N., Radiometric analysis of Hazara phosphate rock and fertilizers in Pakistan, *J. Environ. Radioactivity* **38** (1998) 77–84.
- [6] MAZZILLI, B.P., PALMIRO, V., SAUEIA, C., NISTI, M.B., Radiochemical characterization of Brazilian phosphogypsum, *J. Environ. Radioactivity* **49** (2000) 113–122.
- [7] SILVA, N.C., FERNANDES, E.A.N., CIPRIANI, M., TADDEI, M.H.T., The natural radioactivity of Brazilian phosphogypsum, *J. Radioanal. Nucl. Chem.* **249** (2001) 251.
- [8] SANTOS, A.J.G., MAZZILLI, B.P., FÁVARO, D.I.T., Characterization of stockpiled phosphogypsum waste in Santos basin, Brazil, *Radioprotection – Colloques.* **37** (2002) 1307–1313.
- [9] SANTOS, A.J.G., MAZZILLI, B.P., FÁVARO, D.I.T., SILVA, P.C., Partitioning of radionuclides and trace elements in phosphogypsum and its source materials based on sequential extraction methods, *J. Environ. Radioactivity* **87** (2006) 52–61.
- [10] SILL, C.W., Determination of radium-226 in ores, nuclear wastes and environmental samples by high-resolution alpha spectrometry, *Nucl. Chem. Waste Management* **7** (1987) 239–356.
- [11] CAMARGO, I.M.C., MAZZILLI, B., Determination of uranium and thorium isotopes in mineral spring waters, *J. Radioanal. Nucl. Chem.* **212** (1996) 251–258.

# Characterization and modelling of naturally occurring radioactive material releases from a phosphogypsum disposal area in Greece

D. Pérez-Sánchez<sup>a</sup>, V. Koukoulidou<sup>b</sup>, K. Kehagia<sup>b</sup>

<sup>a</sup>CIEMAT, Departamento de Medio Ambiente,  
Avenida Complutense 22, 28040 Madrid, Spain

<sup>b</sup>Greek Atomic Energy Commission, Division of Licensing and Inspections  
Department of Environmental Radioactivity  
P.O. Box 60092, 15310 Agia Paraskevi, Greece

**Abstract.** At the north part of Greece a phosphate fertilizer industry is in operation since 1975. The produced 145 m<sup>3</sup>/h phosphogypsum (wet production 30% b.w) is deposited continuously near the industry, by the sea side, in a 6 basins (height: 2 -12m) open land disposal area of 563240 m<sup>3</sup>. The underground clay layer is not uniform. Moreover, it has a slope and in some areas it disappears, so the vertical leakage is favored. The underground water pH is significantly low (min= 1.93), specially at the north part of the disposal. The low pH values are correlated with increased SO<sub>4</sub> and P<sub>2</sub>O<sub>5</sub> concentrations. The underground water pollution is mainly due to underground phosphogypsum drainage water runoffs (10-20 m<sup>3</sup>/h), mainly at north, east and south where water permeable layers at the underground water level exist. At the west side, the existing draining channel, the very low permeable layer (clay), the absence of a leakage point (based on piezoelectric measurements) and the direction (west to east) of the underground water flow, prevent the surface and underground runoffs. In order to evaluate the releases of the natural radionuclides from the disposal area to the nearby environment, phosphogypsum measurements with gamma spectrometry and determination of uranium isotopes & <sup>226</sup>Ra with alpha-spectrometry in underground and surface water samples collected from different sampling points, have been performed. The <sup>238</sup>U concentration in underground water varies from 120 up to 1060 mBq/l, while the <sup>226</sup>Ra from 8 up to 5880 mBq/l. High <sup>238</sup>U and <sup>226</sup>Ra concentrations have been observed at the north part of the disposal area. A model was applied for assessing the behavior of the natural radionuclides U and Ra in the surrounding environment of disposal phosphogypsum site. The model includes the performance assessment, obtaining the water flow and radiological parameters based on experimental data. From field and laboratory data, it has been possible to obtain parameters for the driving processes considered in the model, water fluxes, source term definition, and distribution coefficients. The model consider for both waters flows and mass balance of the radionuclides in a natural environment, provides assessments of radionuclides behavior in groundwater, surface water and including processes of radionuclide migration through land and water. The model has been implemented in a flexible software package RESRAD permits either deterministic or probabilistic calculations to be undertaken for the specific data of the site. In the presented work deterministic calculations will be presented.

## 1. Introduction

The fertilizer industry is related with the production of major plant nutrients-nitrogen, phosphorus and potassium- in plant- available forms. The raw material for the phosphorus production is the phosphate ore in the form of calcium phosphates Ca<sub>3</sub>(PO<sub>4</sub>)<sub>2</sub> (phosphorites) and apatite (3Ca<sub>3</sub>(PO<sub>4</sub>)<sub>2</sub>.CaF<sub>2</sub>). Phosphorites have a typical activity concentration of natural uranium of 1.5 Bq/g [1]. Radionuclides in the thorium decay chain are also present, but their activity concentration is one or two orders of magnitude less than the uranium series. In the wet process, phosphoric acid (H<sub>3</sub>PO<sub>4</sub>) is been produced by reaction with sulphuric acid, and phosphogypsum (CaSO<sub>4</sub>·2H<sub>2</sub>O) is being formed as a by-product. The phosphoric acid can be combined with ammonia (NH<sub>3</sub>) to make ammonium phosphate, which is the basis of mixed fertilizers. There is strong evidence that radium isotopes are more readily retained than other radionuclides in phosphogypsum (about 80% of the concentration in the ore). A simplified chemical reaction for the wet process may be shown as follows [1]:

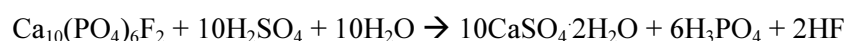

The enhanced concentration of natural radionuclides in the raw material of such industries has as a result the contamination of by-products, wastes, such as phosphogypsum, which is usually disposed in stacks.

## 2. Description of the phosphogypsum disposal site

The fertilizer industry is in operation since 1965 and is situated in north Greece and produces 145m<sup>3</sup>/h phosphogypsum (wet production 30% b.w). The phosphogypsum disposal area is 563240 m<sup>2</sup> and consists of 6 basins of 2 up to 12m height (figure1). The underground water is a mixture of sea water, phosphogypsum sludge water and underground fresh water. At the south of the disposal site a gypsum bank of 2m height has been constructed, that prevents the possible phosphogypsum water sludge leakage. At the west side a 5m wide and 2m deep draining channel collects the surface sludge water runoffs from that side. Phosphogypsum is no more deposited at the south side. The existing bank made from compressed gypsum and clay prevents the surface water leakage. At the end of the draining channel a pump filters and drives the leakage water and transfers it back to the industry for recycling. The underground clay layer is not uniform. Moreover, it has a slope and in some areas it disappears, so the vertical leakage is favored. The underground water flux varies between 20 and 30 m<sup>3</sup>/h. The phosphogypsum hydraulic conductivity  $k_f$  (classification according to Din 18 130E1979) varies between  $2.85 \cdot 10^{-8}$  m/s to  $1.65 \cdot 10^{-7}$  m/s (low or very low water permeability). The total surface water runoff rate, the underground water runoff rate and the rainfall are 57.5, 25 and +25.8 m<sup>3</sup>/h, respectively. The total water balance is  $\pm 145.8$ m<sup>3</sup>/h and the underground water conductivity is approximately 25ms/cm.

## 3. Materials and methods

### 3.1. Sampling

The fertilizer industry, during the year 2005 collected phosphogypsum, underground and surface water samples as follows:

- 19 phosphogypsum samples collected from different parts and in different depths from the basins 2, 3 and 4. Additionally 5 fresh phosphogypsum samples collected directly from the sludge pipeline. The fresh samples were average samples representing a 3 months production period.
- 10 underground water samples from the existing drillings around the disposal site (Sampling locations: G##).
- 11 surface water samples collected at the edge of the phosphogypsum disposal site. (Sampling locations: EN##).

The sampling locations are presented in the Fig. 1.

### 3.2. Laboratory measurements

#### 3.2.1. Gamma spectrometry

The collected phosphogypsum samples have been dried, homogenized and placed in 260ml plastic containers. The beakers were sealed with epoxy glue and stored for 30 days before measured in order to ensure the radon daughters reached secular equilibrium. All measurements have been performed with 2 high purity germanium detectors (CANBERRA), with relative efficiency 70% and 50% respectively. The software used for the analysis was CANBERRA Genie 2000. The activities of the main natural radionuclides were calculated as follows:

- <sup>226</sup>Ra: from the weighted mean activity of the progenies <sup>214</sup>Pb & <sup>214</sup>Bi
- <sup>238</sup>U: from the <sup>234</sup>Th (92.37 & 92.79 keV) and <sup>234m</sup>Pa (1001.03 keV).

The  $\gamma$ -spectroscopic measurements in the phosphogypsum collected samples are presented in Table I and the expanded uncertainty is given at the 95% confidence level.

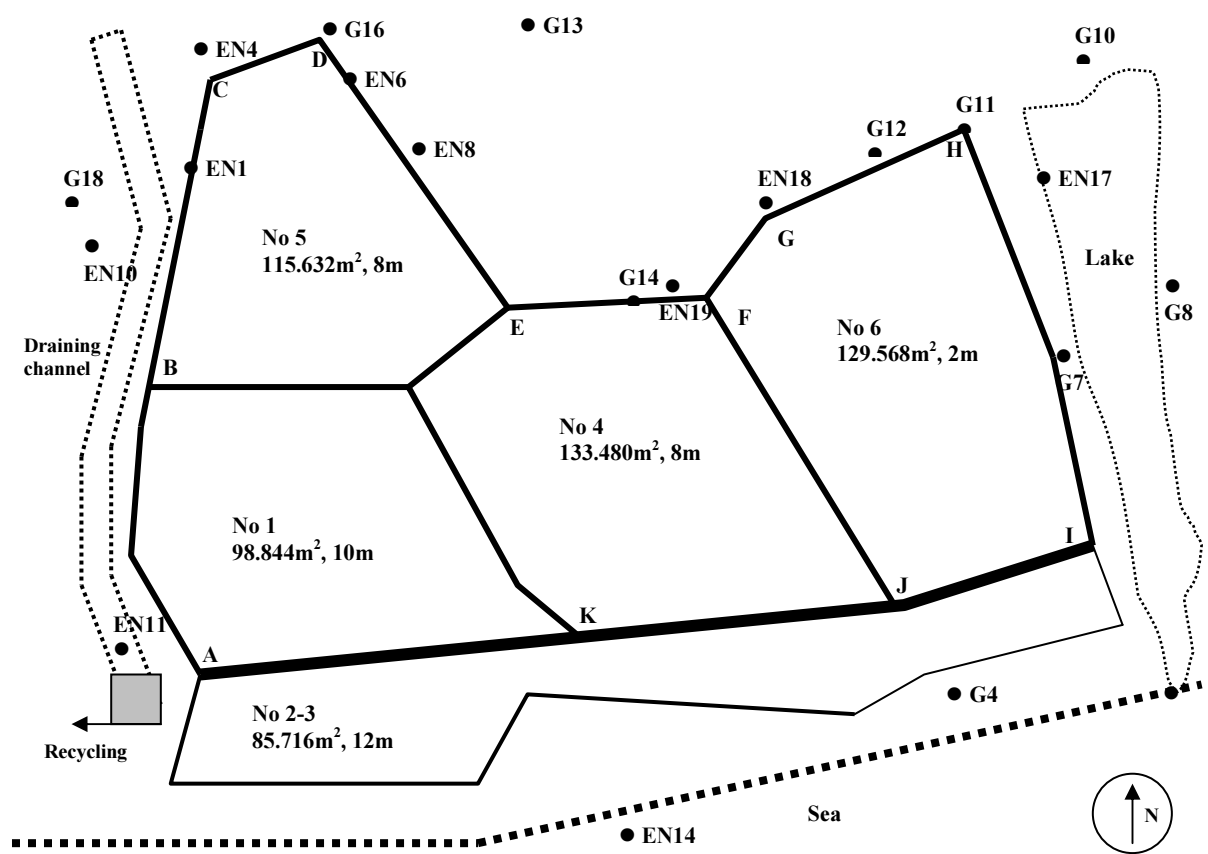

FIG. 1. Phosphogypsum disposal site, surface water sampling locations: EN#, underground water sampling locations: G#.

TABLE I. GAMMA SPECTROSCOPIC MEASUREMENTS IN 24 PHOSPHOGYPSUM SAMPLES

	<sup>226</sup> Ra (Bq/kg)	<sup>238</sup> U (Bq/kg)
Min-max	250-843	12-84
Mean	439	38
Uncertainty <sup>a</sup>	276	33

3.2.2. Alpha spectrometry — uranium and radium determination in surface and underground water

The 1 L water sample was filtered through a Millipore paper and <sup>229</sup>Th (NIST SRM 4328B) and <sup>232</sup>U (NIST supplied) were added as isotopic tracers, respectively. Radium was precipitated by Pb, while uranium remains in the supernatant.

(a) Uranium separation

The separation of uranium from the aqueous matrix was performed by cation exchange using Chelex-100 resin and extracted with 30% TBP/distilled H<sub>2</sub>O, according to the method from Pashalidis [2]. The source for the alpha spectrometry is done by electrodeposition. The uranium activity is measured by alpha spectrometry. The minimum detection activity of this method (95% confidence level) is 60 μBq/L <sup>238</sup>U for a counting time of 7200 min, corresponding to 4.8 ng/L U<sub>nat</sub>. The equipment used is a fully automated and integrated alpha spectroscopic system (Alpha Analyst, Canberra), consisting of 12 passivated implanted planar silicon (PIPS) detectors with 600

mm<sup>2</sup> active area. The detection counting efficiency is 23%. The addition of <sup>232</sup>U-tracer allows the determination of the chemical yield, which is found to vary between 35–73%.

(b) Radium separation

According to the radium determination procedure described by Hancock and Martin [3] for environmental samples, the precipitate with radium was dissolved with ammoniacal EDTA solution (pH 10) and 2–3 drops ammonia. Interfering elements were eliminated by anion and cation exchange, respectively. Radium was electrodeposited in HCl/Ethanol solution, onto a stainless steel disc and measured by alpha spectroscopy. The chemical yield and the activity concentration of the <sup>226</sup>Ra were calculated via the <sup>229</sup>Th daughter radionuclide <sup>217</sup>At. Using the time evolution formulas to calculate the <sup>217</sup>At growth from its parent radionuclide <sup>225</sup>Ra, computer software was developed. This software was incorporated in a database, which automatically calculate and store the results. The minimum detectable activity for <sup>226</sup>Ra, based on an average detector efficiency of 23% and a counting period of 7200 min, was 0.25mBq/L.

The results of the  $\alpha$ -spectroscopic measurements in the surface and underground water samples are presented in the Table II and the expanded uncertainty is given at 95% confidence level. As can be concluded from the measurements, the highest values in underground water were found mainly at the north side of the disposal.

TABLE II. URANIUM AND RADIUM IN SURFACE AND UNDERGROUND WATER

Sampling point	<sup>238</sup> U (mBq/L)	U ( $\mu$ g/L)	<sup>234</sup> U (mBq/L)	<sup>226</sup> Ra (mBq/L)
<i>Underground water</i>				
G4	249 $\pm$ 55	20	274 $\pm$ 60	9 $\pm$ 2
G14	1060 $\pm$ 85	86	1028 $\pm$ 82	645 $\pm$ 130
G16	341 $\pm$ 17	28	347 $\pm$ 17	3520 $\pm$ 940
G7	405 $\pm$ 100	33	503 $\pm$ 114	1405 $\pm$ 170
G8	121 $\pm$ 19	10	119 $\pm$ 19	98 $\pm$ 11
G10	297 $\pm$ 41	24	305 $\pm$ 42	119 $\pm$ 10
G11	912 $\pm$ 100	74	945 $\pm$ 102	5880 $\pm$ 510
G12	280 $\pm$ 30	23	268 $\pm$ 28	1308 $\pm$ 105
G13	870 $\pm$ 140	70	1017 $\pm$ 170	1625 $\pm$ 260
G18	244 $\pm$ 20	18	237 $\pm$ 24	514 $\pm$ 32
<i>Surface water</i>				
EN1	2180 $\pm$ 190	176	2320 $\pm$ 200	134 $\pm$ 24
EN4	29 $\pm$ 8	2	35 $\pm$ 9	N.D.
EN6	426 $\pm$ 42	34	448 $\pm$ 44	N.D.
EN8	250 $\pm$ 20	20	251 $\pm$ 19	1110 $\pm$ 240
EN10	147 $\pm$ 10	12	143 $\pm$ 9	62 $\pm$ 14
EN11	1352 $\pm$ 81	109	1367 $\pm$ 82	23 $\pm$ 6
EN14	67 $\pm$ 8	5	73 $\pm$ 9	19 $\pm$ 2
EN17	22 $\pm$ 4	2	23 $\pm$ 4	178 $\pm$ 15
EN18	1037 $\pm$ 121	84	987 $\pm$ 115	73 $\pm$ 6
EN19	245 $\pm$ 43	20	280 $\pm$ 49	14 $\pm$ 3
EN22	26 $\pm$ 9	2	42 $\pm$ 11	15 $\pm$ 2

## 4. Model description

### 4.1. RESRAD offsite

RESRAD is a computer code developed at Argonne National Laboratory [5] for the US Department of Energy to calculate site specific residual radioactive materials guidelines and radiological dose/risk to an on-site or off site individual at a radioactively contaminated site. RESRAD uses a pathway analysis method in which a pathway sum is calculated to relate the radiological dose/risk to the concentration of the radionuclide in the contaminated material. The pathway sum is the sum of pathway factors for each of the applicable pathways. The pathway factor accounts for radioactive decay and in growth, transport, transfer, bio-accumulation, and radiological potency of the contaminant. RESRAD-OFFSITE, couples an atmospheric dispersion model and a groundwater transport model with RESRAD, thereby permitting calculation of doses to persons located beyond the boundary of the site. The present work mainly concentrates at the water pathway. According to RESRAD a water pathway segment connects the contaminated zone with a point of water withdrawal for drinking or irrigation or with a pond where aquatic foods are raised for human consumption. This segment is characterized by a water/soil concentration ratio for each radionuclide, which is defined as the ratio of the radionuclide concentration in the water at the point of withdrawal or use to the radionuclide concentration in the contaminated zone.

Two models are used for calculating the water/soil concentration ratio for the groundwater pathway segment: a mass balance (MB) model and a non-dispersion (ND) model. The MB model assumes that all radionuclides released annually from the contaminated zone are withdrawn through a well located at the center of the contaminated zone. The ND model assumes that the dispersivity is nil, that the vadose zone and aquifer are homogeneous, and that the well is located at the down-gradient edge of the contaminated zone. If the well is not located at the edge of the contaminated zone (i.e., if it is located off site), then both advection and dispersion of contaminants in the groundwater system must be considered. The surface water is assumed to be a pond for which (1) the water inflow and outflow are in steady-state equilibrium and (2) the annual inflow of radioactive material into the pond equals the annual quantity of radioactive material leached from the contaminated zone. The dilution factor is assumed to be the ratio of the annual volume of water that infiltrates the contaminated zone to the annual total inflow of water into the pond.

RESRAD-OFFSITE includes a transport model that considers the following processes when modeling radionuclide transport in groundwater: (1) advective transport through the mobile pores in the soil, (2) dispersive transport in the soil moisture, (3) equilibrium (linear) adsorption and desorption of nuclides on soil surfaces, (4) diffusion of radionuclides into and out of some of the immobile pores, and (5) decay and ingrowth due to radiological transformations. The off-site accumulation model in RESRAD-OFFSITE considers radiological transformations, mixing of soil in the surface layer, erosion of the surface layer, and equilibrium desorption release in computing the concentrations of radionuclides in surface soil.

### 4.2. Description of the scenario

The source term is an area defined by the points DEFGH (Fig. 1), which is in contact with the surface water body. Based on the geological structures at the drilling points G16, G14, G12 and G11, the phosphogypsum is in close contact with the underground water body, so no unsaturated zone was considered (pessimistic assumption). The only pathway considered in the model is the ground water release taking into account the water mass balance including precipitation, rainfall, evaporation and runoffs. The present work focuses on the behavior of the radionuclides in the surface water and compares the estimated concentrations with the measured values.

RESRAD OFFSITE default parameters were used, as well as user defined parameters. The last ones were based on measurements performed by the industry included in the environmental study of the disposal site. Some of the specific site parameters are mentioned below:

- Exposure time : 1000y
- Radionuclides of concern:  $^{238}\text{U}$  and  $^{226}\text{Ra}$
- The nuclides concentrations for the source term are the mean values of the measured phosphogypsum samples: 38Bq/kg  $^{238}\text{U}$  and 439 Bq/kg  $^{226}\text{Ra}$ .
- Precipitation: 0.54 m/y, based on local area average precipitation for the years 1960 until 1996.
- Water evaporation: 821 mm/y
- Runoff coefficient: 0.76
- Thickness of contaminated zone: 8 m
- Total porosity: 0.6
- Hydraulic conductivity : 0.88 m/y

One of the parameters that has an important big influence to the model results is the distribution coefficient  $K_d$  that describes the partitioning of the nuclide between the aqueous and solid phases of solid or sediments.  $K_d$  is the ratio of the concentration of the contaminant in the absorbed phase in soil (or sediment), to the concentration of the contaminant in the aqueous phase of soil (or sediments). Due to the lack of the measured value of the parameter for the specific site, the leach rate was used instead, defined as the rate at which the radionuclide leaches from the contaminated zone. The leach rates taken from the literature for similar material [5] were 0.3 and 0.03 for  $^{238}\text{U}$  and  $^{226}\text{Ra}$  respectively.

## 5. Results

At the first stage, the modeling evaluation was mainly focused on the surface water contamination. The underground water evaluation will be completed in a second stage based on more site specific data, in order to characterize the existing situation in a more realistic way.

The  $^{238}\text{U}$  and  $^{226}\text{Ra}$  concentrations in surface water, calculated with the RESRAD OFFSITE, are presented in Figs 2 and 3.

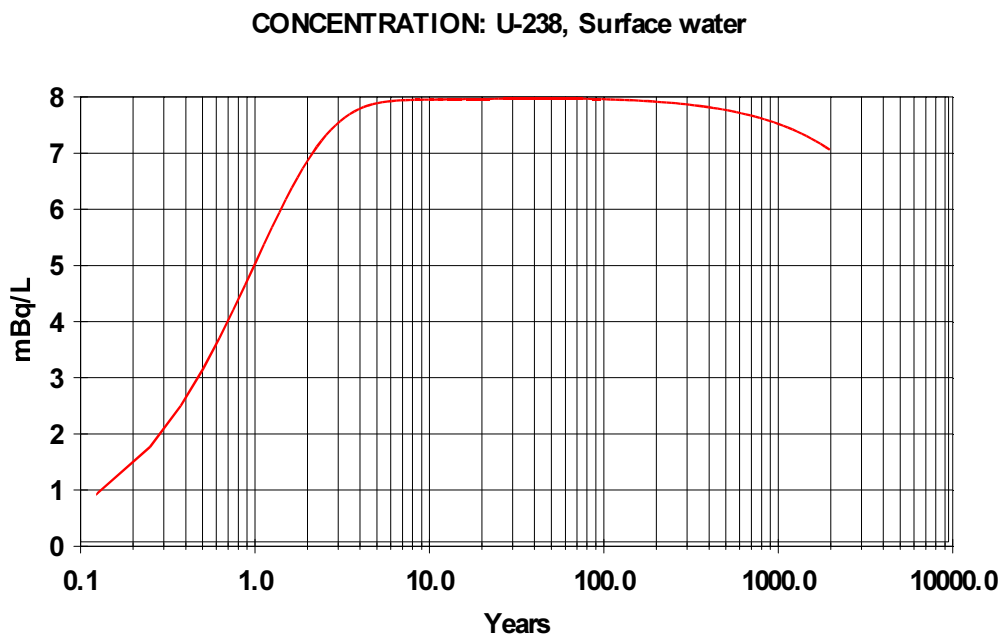

KAVALA\_OFFSITE.ROF 01/30/2007 12:39 GRAPHICS.ASC

*FIG. 2.  $^{238}\text{U}$  concentration in surface water calculated with RESRAD OFFSITE*



### CONCENTRATION: Ra-226, Surface water

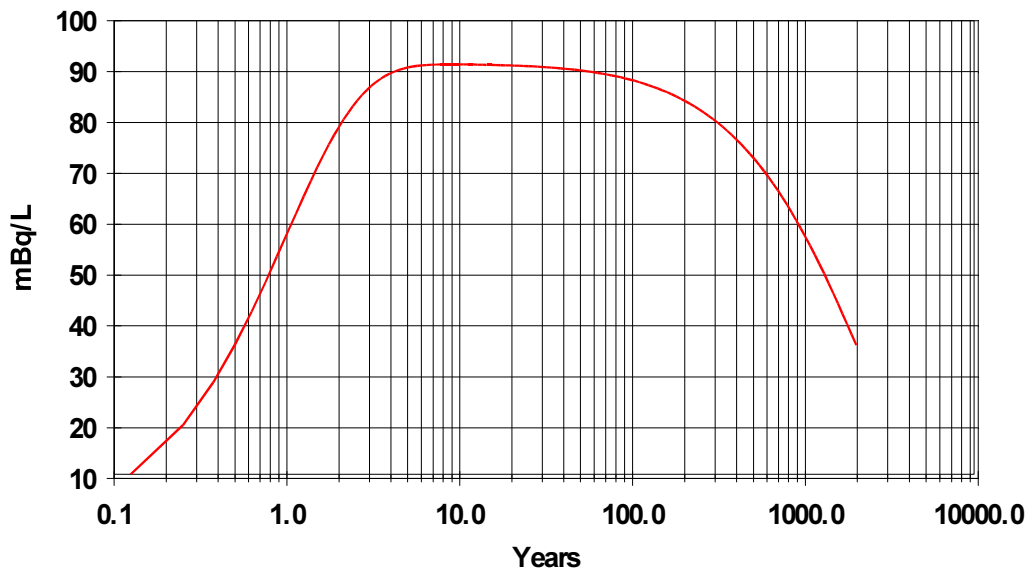

KAVALA\_OFFSITE.ROF 01/30/2007 12:39 GRAPHICS.ASC

FIG. 3.  $^{226}\text{Ra}$  concentration in surface water calculated with RESRAD OFFSITE

The concentration of the contaminants in the surface water is due to two main pathways. The most important one is due to surface runoff of material from the disposal, depended on the rainfall regime (heavy rain, quantity and season) and the second one, most delayed, is due to underground water contamination.

The RESRAD OFFSITE results showed that the predicted concentrations for  $^{226}\text{Ra}$  in surface water are higher than for  $^{238}\text{U}$ . The much higher  $^{226}\text{Ra}$  concentration in the phosphogypsum compared with  $^{238}\text{U}$ , could explain the predicted higher  $^{226}\text{Ra}$  concentration due to surface runoffs pathway. This statement is not in agreement with the measured values, where the  $^{238}\text{U}$  concentration in the surface water is higher than the corresponding  $^{226}\text{Ra}$ . The predicted values for the surface water  $^{226}\text{Ra}$  concentration seem to be in the same order of magnitude with most of the measured ones; however this is not the case for the  $^{238}\text{U}$ .

## 6. Conclusions

The use of a model such as RESRAD OFFSITE could give an initial estimation of the behavior of the radionuclides in the surrounding environment of a phosphogypsum disposal area. One of the main objectives of the model's use could be the long term evaluation of the proposed remediation actions and from the regulatory point of view, the consistency with the existing guidelines for discharges.

At this stage of the work, the underground pathway was not taken into account and that might result to the observed difference between the predicted  $^{238}\text{U}$  concentration in surface water and the measured values. The much higher leach ratio of  $^{238}\text{U}$  favors the vertical infiltration through the low water permeable geological structures, to groundwater and might increase the  $^{238}\text{U}$  surface water concentration.

A more detailed approach, including realistic site specific parameters, is needed for a more precise evaluation of the existing situation and for any long term prediction. Additionally, systematic measurements of  $^{238}\text{U}$  and  $^{226}\text{Ra}$  concentration in surface and underground water have to be performed

in different time seasons in order to have a more accurate recording and monitoring of the eventual phosphogypsum leakage to the surrounding environment.

#### REFERENCES

- [1] BURNETT, W.C., HULL, C.D., Problems and possible remedies concerning NORM in by-product gypsum produced by the phosphate industry, Health Physics Society Meeting, Arizona, 1996.
- [2] PASHALIDIS, I., TSERTOS, H., Radiometric determination of uranium in natural waters after enrichment and separation by cation-exchange and liquid-liquid extraction, *J. Radioanalyt. Nucl. Chem.* **260** 3 (2004) 439–442.
- [3] HANCOCK, G.J., MARTIN, P., Determination of Ra in environmental samples by  $\alpha$ -particle spectroscopy, *Appl. Radiat. Isot.* **42** (1991) 63–69.
- [4] RESRAD-OFFSITE, Environmental Science Division of Argonne National Laboratory, [www.env.anl.gov/resrad](http://www.env.anl.gov/resrad)
- [5] AGUADO CASAS, J.L., BOLÍVAR RAYA, J.P., DE SAN MIGUEL HERRERA, E.G., GARCÍA-TENORIO, R., A sequential extraction procedure to determine Ra and U isotopes by alpha-particle spectrometry in selective leachates, *Czech. J. Phys.* **53** (2003).

# Estimation of the amount of anthropogenic uranium in 112 Japanese agricultural soil samples due to application of phosphatic fertilizers

S. Uchida, K. Tagami

Office of Biospheric Assessment for Waste Disposal  
National Institute of Radiological Sciences  
Chiba, Japan

**Abstract.** We determined concentrations of total Th and U in 112 Japanese agricultural soil samples (50 paddy field and 62 upland field soil samples) were determined by ICP-MS after microwave digestion. The average concentrations of total Th and U in the paddy field soil samples were  $5.7 \text{ mg kg}^{-1}$  and  $2.8 \text{ mg kg}^{-1}$ , respectively, while those in the upland field soil samples were  $2.6 \text{ mg kg}^{-1}$  and  $5.5 \text{ mg kg}^{-1}$ , respectively. These Th and U concentrations showed no differences between paddy field and upland field soil samples. Concentration ratios of U/Th in paddy field and upland field soils were 0.53 and 0.52 on average, respectively, which were much higher than those in Japanese non-agricultural fields (0.23). The results implied that phosphatic fertilizers, which have high U concentrations, increased the total U concentration in the agricultural fields. Thus, using the natural U/Th ratio in non-agricultural areas, we estimated the excess amount of U. About 52% of total U in paddy field soils (ca.  $1.5 \text{ mg kg}^{-1}$  of U on average) and 50% of total U in upland field soils (ca.  $1.3 \text{ mg kg}^{-1}$  of U on average) were calculated as excess amounts of U. Thus using of phosphatic fertilizers in agricultural fields makes only a small contribution as external radiation to the general population.

## 1. Introduction

Uranium (U) and thorium (Th) behaviour in geological environments are relatively close to each other compared to their behaviours and those of other elements. Thus high relations between their concentrations are usually observed in rocks, non-agricultural field soil samples and river sediments, etc. Indeed, in Japan the concentration ratios of U/Th in these environmental samples were almost the same, being about 0.20–0.28 in Japan [1–4]. However, applications of phosphatic fertilizers to agricultural fields might increase their U concentration since the fertilizers are known to be high in U content (fertilizer U contents are 10–300 times higher than U contents in uncontaminated soils) but low in Th content [5–7]. Thus the U/Th ratios in phosphatic fertilizers are significantly higher than the natural U/Th ratio.

In order to estimate the excess amount of U ( $U_{\text{ess}}$ ) in agricultural fields, it is necessary to obtain native U concentrations in those fields. These concentrations would be obtained if soil samples were collected at a depth of about 50–100 cm from the surface, where no U migration from the surface soil layer has been observed. Indeed, Takeda et al. [8] measured the vertical distribution of U in an agricultural field and found U concentration in the surface soil layer was high but it decreased at a depth from 25–35 cm and then became constant. Another possibility is to collect soil samples from non-agricultural fields near the sampling sites; their original soil properties would be almost the same, and as well as their native U concentrations. However, for both cases, it is necessary to measure at least two samples to estimate the amount of  $U_{\text{ess}}$ , which is time consuming and it is also sometimes difficult to find suitable sampling sites. It should be noted that the use of a U isotope ratio such as  $^{235}\text{U}/^{238}\text{U}$  is not effective since the U in the phosphatic fertilizers generally has the natural isotope abundance for these isotopes.

Natural U/Th ratio in non-agricultural fields would be useful to estimate content of  $U_{\text{ess}}$  in agricultural fields [9]. Concentrations of U and Th in soil are closely related to the original materials of the soil [1],

but U is more mobile than Th is so that U/Th ratio in natural U ratio in non-agricultural fields is slightly lower than the parent rock. From the average composition of the Japan upper crust, the U/Th ratio is 0.28 [3], but in non-agricultural fields, 0.22–0.25 ratios were observed [1, 2, 4].

In this study, we estimated excess amounts of U in Japanese agricultural fields due to phosphatic fertilizer application by using inductively coupled plasma mass spectrometry (ICP-MS) to measure concentrations of total U and Th in 112 agricultural soil samples. The samples were collected throughout Japan.

## 2. Experimental

### 2.1. Sample collection

Surface layer (0–20 cm) soil samples from paddy fields and upland fields were collected nationwide from 50 and 62 sampling sites, respectively, in 2002–2005 (Fig. 1). These samples were air-dried and passed through a 2 mm mesh sieve. Then the samples were thoroughly ground into fine powder.

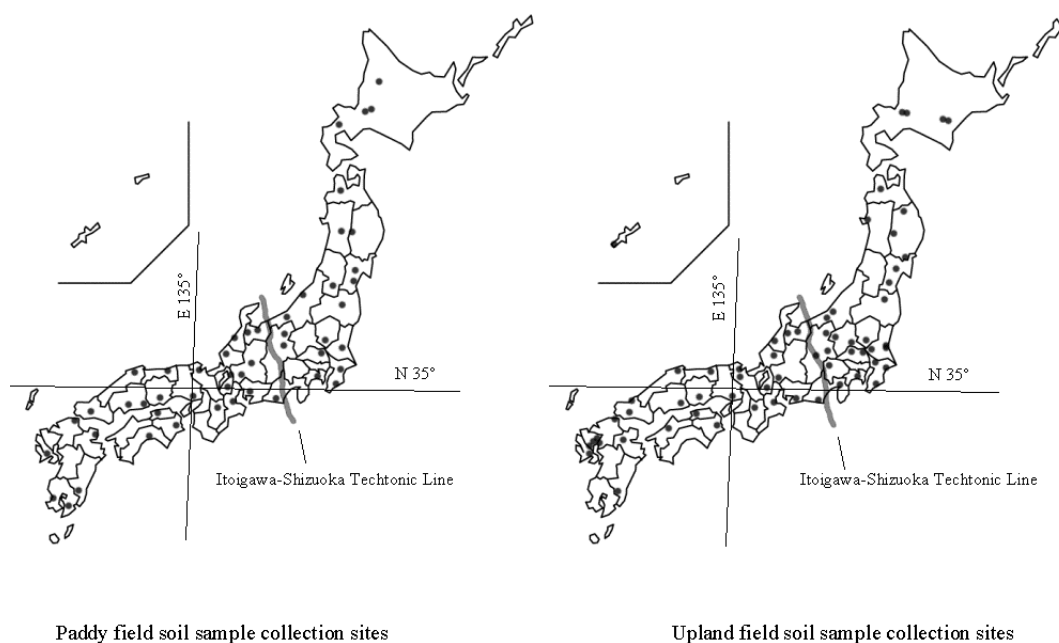

FIG.1. Sample collection sites in Japan.

### 2.2. Total U and Th measurement

The finely ground samples, 100 mg each, were digested with mixed acid using a microwave digester (CEM, Mars 5). Following their digestion, soil samples were evaporated to near dryness at 140°C. The residue was dissolved with 1 mL of conc. nitric acid and 0.5 mL of hydrogen peroxide and evaporated again. Finally, the residue was dissolved with 1 mL of 40% nitric acid and diluted with deionized water (Milli-Q). After diluting the acid solutions to a suitable concentration, U and Th in them were measured using ICP-MS (Yokogawa, Agilent 7500). Standard solutions were obtained by diluting a multi-element standard solution for ICP (SPEX, XSTC-13 or 355).

### 3. Results and discussion

#### 3.1. Comparison of concentrations of U and Th in agricultural soils samples by land uses and areas

Since the main island of Japan is geologically classified into two parts at the Itoigawa-Shizuoka Tectonic Line as shown in Fig. 1, U and Th concentrations in samples collected in the northeastern (NE) and southwestern (SW) parts of Japan were compared. Fig. 2 shows probability distributions of U and Th concentrations in paddy field soil (P) and upland field soil (F) samples. Both P and F samples showed that Th concentrations in SW were statistically higher than in NE ( $p < 0.001$ ). For U, the concentrations were higher in SW than in NE for F samples ( $p < 0.01$ ), but no difference was observed for P samples. The SW part is largely covered with granite so that U and Th concentrations are usually higher in SW than in NE, but no significant U/Th concentration ratio difference occurs in non-agricultural soils [1]. Our results implied that U addition to the agricultural fields has been done artificially, without recognition.

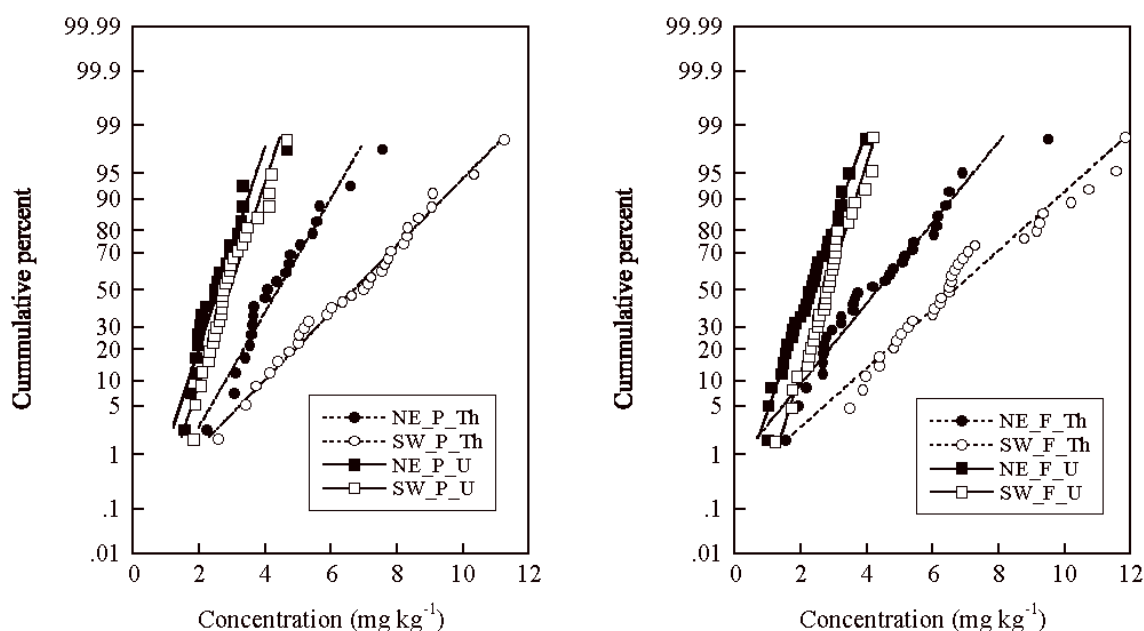

FIG.2. Probability distributions of U and Th in paddy field soil (left) and upland field soil (right) samples collected in northeastern and southwestern parts of Japan.

Concentrations of U and Th concentrations are summarized in Table I. There was no difference between land uses, that is, P and F samples. The average concentrations of total Th and U in the former were  $5.7 \text{ mg kg}^{-1}$  and  $2.8 \text{ mg kg}^{-1}$ , respectively, while those in the latter were  $2.6 \text{ mg kg}^{-1}$  and  $5.5 \text{ mg kg}^{-1}$ , respectively. Concentration ratios of U/Th in P and F samples were 0.53 and 0.52 on average, respectively, which were much higher than those in Japanese non-agricultural fields (0.23).

TABLE I. CONCENTRATIONS OF Th, U AND EXCESS U ( $U_{\text{ess}}$ ) IN PADDY FIELD AND UPLAND FIELD SOIL SAMPLES ON A DRY WEIGHT BASIS AND AVERAGE RATIOS OF  $U_{\text{ess}}/U$

Element	Northeastern part		Southwestern part		Total		
	Paddy field	Upland field	Paddy field	Upland field	Paddy field	Upland field	
	N=21	N=30	N=29	N=32	N=50	N=62	
	mg kg <sup>-1</sup>	mg kg <sup>-1</sup>	mg kg <sup>-1</sup>	mg kg <sup>-1</sup>	mg kg <sup>-1</sup>	mg kg <sup>-1</sup>	
Th	Max.	7.6	9.5	11.3	11.9	11.3	11.9
	Min.	2.3	1.6	2.6	1.2	2.3	1.2
	Avg.	4.4	4.3	6.7	6.7	5.7	5.5
U	Max.	4.7	4.0	4.7	4.2	4.7	4.2
	Min.	1.6	1.0	1.8	1.2	1.6	1.0
	Avg.	2.6	2.3	2.9	2.8	2.8	2.6
$U_{\text{ess}}$	Max.	3.4	2.3	3.6	2.7	3.6	2.7
	Min.	0.8	0.3	0.2	-0.2	0.2	-0.2
	Avg.	1.6	1.3	1.4	1.3	1.5	1.3
$U_{\text{ess}}/U$	Avg.	0.60	0.56	0.46	0.44	0.52	0.50

### 3.2. Estimation of excess amount of U in agricultural field soil samples

In order to estimate excess amount of U ( $U_{\text{ess}}$ ), natural U/Th ratios could be used because U/Th ratios in phosphatic fertilizers are usually high. Thus, the following equation was used:

$$[U_{\text{ess}}] = [U_{\text{obs}}] - [Th_{\text{obs}}] * U/Th_N$$

where  $U_{\text{obs}}$  is measured total U in soil,  $Th_{\text{obs}}$  is measured total Th in the soil and  $U/Th_N$  is U/Th in initial soil condition (natural ratio).

As mentioned above, U and Th concentrations are highly correlated with each other in rock, non-agricultural soils and river sediments, thus, we thought that it is possible to calculate the amounts of excess U. Therefore, we used the U/Th ratio in non-agricultural areas, 0.23, as an average U/Th ratio in agricultural fields before application of phosphatic fertilizers [1, 2, 4].

The  $[U_{\text{ess}}]$  ranged from <0.2 to 3.6 mg/kg-dry in P samples and from <0 to 2.7 mg/kg in F samples, with arithmetic means of 1.5 and 1.3 mg/kg, respectively. Figs 3 and 4 show frequency distributions of estimated  $U_{\text{ess}}$  concentrations in P and U samples and those in northeastern and southwestern parts of Japan, respectively. As shown in the Figures, there were no  $[U_{\text{ess}}]$  differences between land uses or areas.

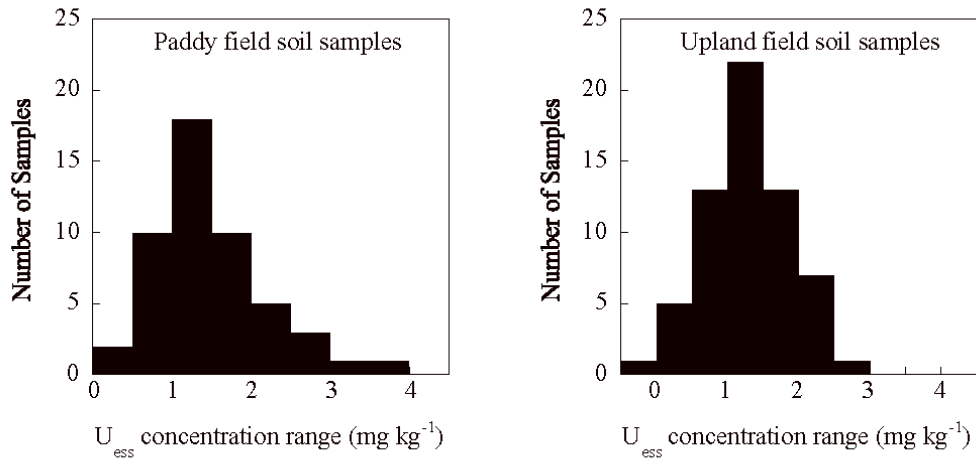

FIG. 3. Frequency distributions of estimated  $U_{ess}$  concentrations in paddy field soil and upland field soil samples.

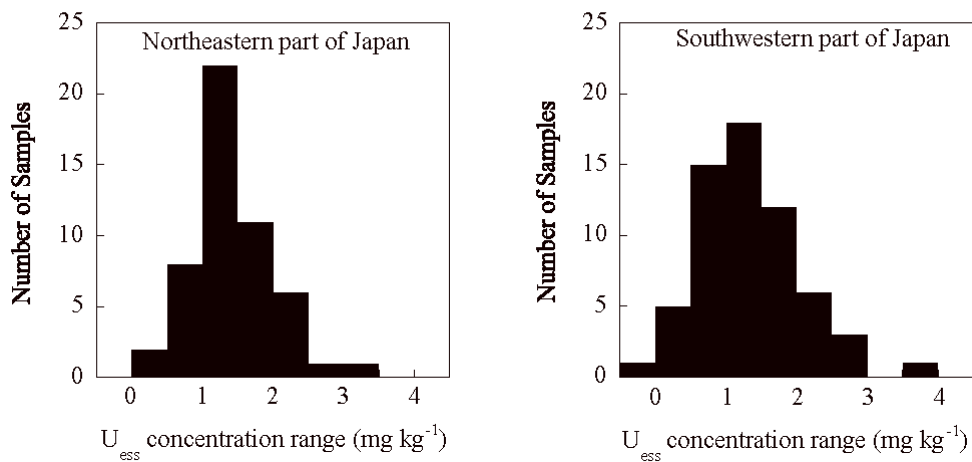

FIG. 4. Frequency distributions of estimated  $U_{ess}$  concentrations in northeastern and southwestern parts of Japan.

From the results, we estimated that 52% of total U in P samples and 48% of total U in F samples originated from the phosphatic fertilizers. Although U in the fertilizers is more mobile than U originating from the soil [5], the uptake ratio of U from soil (Bq/kg-dry or mg/kg-dry) to plant (Bq/kg-dry or mg/kg-dry) through the roots is very small [10], i.e. of the order of 0.001–0.01, so the dose effect due to ingestion of the excess U would be negligible. However, we found the U levels in agricultural fields had been elevated by long-term application of phosphatic fertilizers to them, and U must have a contribution as external radiation to the population, though it would be small portion.

## ACKNOWLEDGEMENT

This work has been partially supported by the Agency for Natural Resources and Energy, the Ministry of Economy, Trade and Industry (METI), Japan.

## REFERENCES

- [1] YAMAGATA, Y., IWASHIMA, K., Terrestrial background radiation in Japan, *Health Phys.* **13** (1967) 1145.
- [2] YOSHIDA, S., MURAMATSU, Y., TAGAMI, K., UCHIDA, S., Concentrations of lanthanide elements, Th and U in 77 Japanese surface soils, *Environ. Int.* **24** (1998) 275.
- [3] IMAI, N., et al., Geochemical Map of Japan, Geological survey of Japan, AIST, Tsukuba (2004). Available at <http://www.aist.go.jp/RIODB/geochemmap/index.htm>.
- [4] TAKEDA, A., KIMURA, K., YAMASAKI, S., Analysis of 57 elements in Japanese soils, with special reference to soil group and agricultural use, *Geoderma* **119** (2004) 291.
- [5] TSUMURA, A., YAMASAKI, S., Behaviour of uranium, thorium and lanthanoids in paddy fields, *Radioisotopes* **42** (1993) 265 (in Japanese).
- [6] HAMAMO, H., et al., Studies of radioactivity and heavy metals in phosphate fertilizer, *J. Radioanal. Nucl. Chem.* **194** (1995) 331.
- [7] MAKWEBA, M.M., HOLM, E., The natural radioactivity of the rock phosphates, phosphatic products and their environmental implications, *Sci. Total. Environ.* **133** (1993).
- [8] TAKEDA, A., et al., Accumulation of uranium derived from long-term fertilizer applications in a cultivated Andisol, *Sci. Total Environ.* **367** (2006) 924.
- [9] TAGAMI, K., UCHIDA, S., Use of a natural U/Th concentration ratio for estimation of anthropogenic uranium concentration in Japanese agricultural soils due to application of phosphatic fertilizers, *Radioisotopes* **55** (2006) 71 (in Japanese).
- [10] INTERNATIONAL ATOMIC ENERGY AGENCY, Handbook of Parameter Values for the Prediction of Radionuclide Transfer in Temperate Environments, Technical Reports Series No. 364, IAEA, Vienna (1994) 14–26.



# Natural radioactivity components in solid waste produced by the manufacture of phosphatic fertilizer

I. Vallés, X. Ortega, I. Serrano, A. Camacho, M.A. Duch

Institut de Tècniques Energètiques. Universitat Politècnica de Catalunya, ETSEIB  
Diagonal 647, 08028 Barcelona, Spain

Email: [isabel.valles@upc.edu](mailto:isabel.valles@upc.edu)

**Abstract.** Phosphatic fertilizers are manufactured from phosphorite, a mineral which is known to contain elevated concentrations of natural  $^{238}\text{U}$  and its daughter products in secular equilibrium. The solid waste coming from a phosphatic fertilizer factory in Tarragona (Spain) is stacked in an industrial dump close to the factory. Measurements of natural radioactivity were carried out on 55 mud samples taken at depths ranging from 0.6 to 13 m from various areas of the dump. High-resolution gamma spectrometry and alpha spectrometry were used to determine the contents of natural radionuclides (uranium, actinium and thorium series). The specific activities of the main radionuclides reached values in the range of 300 to 4500 Bq/kg for  $^{238}\text{U}$ , 700 to 4600 Bq/kg for  $^{234}\text{Th}$ , 1500 to 13 000 Bq/kg for  $^{230}\text{Th}$ , 1400 to 5300 Bq/kg for  $^{226}\text{Ra}$ , 200 to 1700 Bq/kg for  $^{210}\text{Pb}$ , and 400 to 1500 for  $^{210}\text{Po}$ . Non-equilibrium was observed between the activities of the isotopes of the  $^{238}\text{U}$  series. This was especially remarkable for  $^{230}\text{Th}$ , whose activities were higher than 13 000 Bq/kg in some cases. The activities detected for such an isotope were of the order of 2–3 times higher than that of  $^{238}\text{U}$ . The activities of  $^{210}\text{Pb}$  and  $^{210}\text{Po}$  were significantly lower, between 30% and 60% less than that of  $^{238}\text{U}$ . On the other hand, the values of activities detected for  $^{238}\text{U}$ ,  $^{234}\text{Th}$ ,  $^{234}\text{U}$  and  $^{226}\text{Ra}$  were comparable, regardless of the analytical technique used. Similar comments can be made for the values of detected activities of  $^{232}\text{Th}$ ,  $^{228}\text{Ra}$  and  $^{224}\text{Ra}$  in the  $^{232}\text{Th}$  series.

## 1. Introduction

The industrial dump ‘Racó de la Pubilla’ is located approximately 5 km from the town of Flix (Tarragona) in the Catalonia Region of Spain and contains solid waste produced in a factory that makes bicalcium phosphate using phosphorite. Concentrations of  $^{232}\text{Th}$  and  $^{40}\text{K}$  in sedimentary phosphate rocks, or phosphorite, are similar to those normally observed in soil, whereas concentrations of  $^{238}\text{U}$  and its decay products tend to be elevated in phosphate deposits of a sedimentary origin. The UNSCEAR (1993) indicates 1500 Bq/kg as a typical concentration of  $^{238}\text{U}$  in phosphate deposits.  $^{238}\text{U}$  and its decay products are generally found in close radioactive equilibrium in phosphorite (IAEA, 2003).

Industrial processing of phosphorite to manufactured phosphatic fertilizers involves the formation of a solid waste which contains high levels of radionuclides from the uranium series (Bolívar et al., 95, 95b, 98; Barisic et al., 92; Guimond et al., 89).

In this work we have determined the contents of natural radionuclides in mud samples taken from various terraces and depths at the industrial dump ‘Racó de la Pubilla’.

## 2. Materials and methods

### 2.1. Characteristics of the dump

As stated above, the fertilizer plant produces bicalcium phosphate using phosphorite, and at the end of the manufacturing process a residue is obtained in the form of a solid particulate suspension which is treated at a treatment plant. The final sediments are stored at the ‘Racó de la Pubilla’ dump. The dump is located near the village of Flix (Tarragona, Spain) and contains about 400 000 t of solid waste.

The industrial dump is located in a valley of impermeable material, and the waste has been deposited forming 11 terraces that are 10 to 30 m in depth. At present, the installation is formed by an unaltered zone at the entrance, ten terraces in which the sediments have been covered with a layer (0.5 to 1.5 m

thick) of inert soil, and a zone which is still being used. The total difference in height between the entrance and the tenth terrace is approximately 30 m.

Fig. 1 shows an aerial photograph of the zone, identification of the studied terraces (T) and the location of the drilling points.

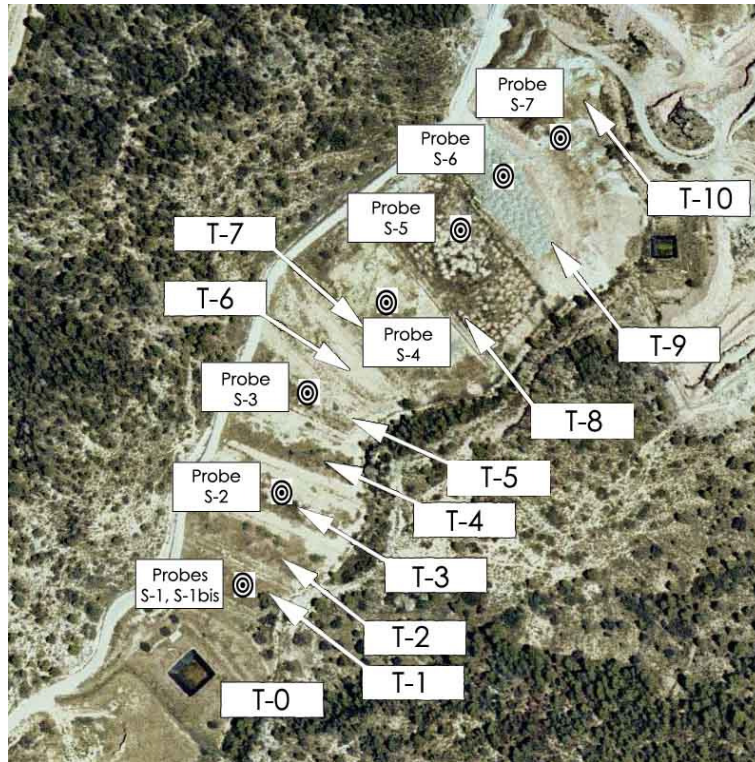

FIG. 1. Identification of terraces (T) and drilling points (S)

## 2.2. Sampling

In the different terraces a total of 7 points were selected. Fig. 1 shows the location of the drilling points (S). Drilling depth was between 6 to 13 m depending on the characteristics of the area.

A total of 55 mud samples were taken at depths ranging from 0.6 to 13 m from different drilling points within the dump.

## 2.3. Radionuclide activity measurements

Radioactivity analysis of the collected mud samples was done at the Radioactivity Analysis Laboratory of the Institute of Energetic Techniques (INTE) and at two additional laboratories of the University of Barcelona and the Autonomous University of Barcelona.

Concentrations of gamma emitted radionuclides and  $^{210}\text{Po}$  were determined in the 55 mud samples while uranium and thorium isotope concentrations were measured in 14 representative mud samples.

Gamma emitting radionuclides ( $^{40}\text{K}$ ,  $^{234}\text{Th}$ ,  $^{230}\text{Th}$ ,  $^{226}\text{Ra}$ ,  $^{210}\text{Pb}$ ,  $^{228}\text{Ra}$ ,  $^{224}\text{Ra}$ ,  $^{235}\text{U}$ ,  $^{231}\text{Pa}$ ,  $^{223}\text{Ra}$ ) were measured at the INTE Laboratory with a germanium semiconductor detector, reverse type, model GX3020 from CANBERRA, a germanium semiconductor detector, model GX4020 from CANBERRA using GENIE 2000 software following our own procedures.

The activity concentrations of some radionuclides were calculated using the measured activities of their daughters because secular equilibrium was established. Therefore,  $^{238}\text{U}$  activity using gamma spectrometry was calculated via  $^{232}\text{Th}$ ,  $^{226}\text{Ra}$  via  $^{214}\text{Pb}$ ,  $^{228}\text{Ra}$  via  $^{228}\text{Ac}$  and  $^{224}\text{Ra}$  via  $^{212}\text{Pb}$ .

Uranium ( $^{238}\text{U}$ ,  $^{234}\text{U}$ ,  $^{235}\text{U}$ ), thorium ( $^{232}\text{Th}$ ,  $^{230}\text{Th}$ ) and  $^{210}\text{Po}$  isotopes were measured using alpha spectrometry (PIPS detector, Canberra model PD-450-17-100-AM). Prior to measurement, uranium and thorium isotopes were separated with a known amount of  $^{232}\text{U}/^{228}\text{Th}$  tracer by ferric hydroxide precipitation. The precipitate was dissolved in 8M nitric acid and the thorium and the uranium were then separated via ion exchange using Dowex-1 anion exchange resin and subsequently eluted with 9M and 1M HCl, respectively.

The accuracy of the specific activity data obtained from gamma and alpha spectrometry was evaluated by means of a quality control programme (inter-comparison tests) between the three universities. The results obtained from this programme were satisfactory.

### **3. Results and discussion**

#### ***3.1. Concentrations of gamma emitters and $^{210}\text{Po}$***

In Table I the activity concentrations of the different gamma emitting radionuclides and  $^{210}\text{Po}$  at each drilling point are summarized.

The specific activities of the main radionuclides reached values in the range of 300 to 4500 Bq/kg for  $^{238}\text{U}$ , 700 to 4600 Bq/kg for  $^{234}\text{Th}$ , 1500 to 13 000 Bq/kg for  $^{230}\text{Th}$ , 1400 to 5300 Bq/kg for  $^{226}\text{Ra}$ , 200 to 1700 Bq/kg for  $^{210}\text{Pb}$ , and 400 to 1500 for  $^{210}\text{Po}$ .

#### ***3.2. Activity concentrations of uranium and thorium isotopes***

In Table II the activity concentrations of uranium and thorium isotopes in 14 representative mud samples are presented. Uranium and thorium isotope activities were measured by alpha spectrometry. Results for  $^{230}\text{Th}$  and  $^{235}\text{U}$  carried out by alpha spectrometry and gamma spectrometry were similar.

#### ***3.3. Radioactivity concentrations in the $^{238}\text{U}$ series***

Fig. 2 shows the activity of the isotopes of the  $^{238}\text{U}$  series in representative mud samples. The method used for the activity determination for each radionuclide is indicated in the Figure.

Non-equilibrium was observed between the activities of the isotopes of the  $^{238}\text{U}$  series. This was especially remarkable for  $^{230}\text{Th}$ , whose activities were higher than 11 000 Bq/kg in some cases. The activities detected for such an isotope were of the order of 2–3 times higher than that of  $^{238}\text{U}$ . The activities of  $^{210}\text{Pb}$  and  $^{210}\text{Po}$  were significantly lower, between 30% and 60% less than that of  $^{238}\text{U}$ . On the other hand, the values of activities detected for  $^{238}\text{U}$ ,  $^{234}\text{Th}$ ,  $^{234}\text{U}$  and  $^{226}\text{Ra}$  were comparable, regardless of the analytical technique used.

#### ***3.4. Radionuclide concentrations in the $^{232}\text{Th}$ series***

Fig. 3 shows the activity of the isotopes of the  $^{232}\text{Th}$  series in representative mud samples. The specific activities of the main radionuclides in this chain were less than those of the isotopes of the  $^{238}\text{U}$  series.

Equilibrium was found between the different radionuclides  $^{232}\text{Th}$ ,  $^{228}\text{Ra}$  and  $^{224}\text{Ra}$ .

TABLE I. MEAN RADIONUCLIDE ACTIVITY CONCENTRATIONS AT EACH DRILLING POINT (Bq/kg)  
(Maximum and minimum values in parentheses)

Drilling point	S-1	S-2	S-3	S-4	S-5	S-6	S-7
Terrace	T 1	T 3	T 5	T 7	T 8	T 9	T 10
$^{40}\text{K}$	165 (154-175)	133 (77-208)	122 (81-172)	111 (62-167)	98 (68-131)	94 (59-142)	92 (45-108)
$^{234}\text{Th}$	1658 (719-2596)	2653 (886-3793)	3193 (2294-4603)	3219 (1393-4611)	2382 (1415-2952)	2405 (1607-3090)	2443 (1956-2794)
$^{230}\text{Th}$	4647 (1538-7755)	6772 (2073-10922)	8267 (6158-10030)	8570 (3528-11969)	7120 (3879-8651)	6631 (3946-13126)	6579 (5243-9035)
$^{226}\text{Ra}$	1431 (398-2463)	2378 (997-3759)	3503 (2339-4905)	3164 (1317-4337)	3077 (1792-4653)	2914 (1940-3872)	3164 (2231-5298)
$^{210}\text{Pb}$	492 (188-796)	949 (329-1364)	1174 (777-1574)	1002 (554-1731)	964 (399-1404)	859 (605-1124)	944 (644-1210)
$^{210}\text{Po}$	668 (261-1075)	1078 (489-1415)	1582 (1167-2048)	1222 (721-1645)	1250 (751-1721)	1112 (788-1390)	1242 (896-1650)
$^{228}\text{Ra}$	53 (32-74)	101 (38-163)	107 (85-128)	122 (50-176)	90 (53-140)	72 (46-87)	64 (51-76)
$^{224}\text{Ra}$	39 (24-53)	73 (42-100)	101 (80-127)	117 (41-192)*	72 (47-88)	62 (42-101)	80 (58-105)
$^{235}\text{U}$	80 (31-130)	198 (43-301)	216 (149-273)	231 (88-419)	171 (90-214)	145 (80-191)	203 (132-257)
$^{231}\text{Pa}$	727 (202-1251)	945 (264-1564)	1196 (830-1415)	1230 (469-1561)	1078 (583-1777)	852 (522-986)	877 (707-1160)
$^{223}\text{Ra}$	225 (97-353)	359 (113-552)	476 (381-534)	485 (220-619)	414 (201-554)	374 (235-517)	371 (278-546)

TABLE II. URANIUM AND THORIUM ISOTOPE ACTIVITIES

Drilling point/sample	Uranium isotopes (Bq/kg)			Thorium isotopes (Bq/kg)	
	$^{238}\text{U}$	$^{235}\text{U}$	$^{234}\text{U}$	$^{232}\text{Th}$	$^{230}\text{Th}$
S1/3	746 ± 47	41 ± 11	829 ± 49	42 ± 21	1093 ± 107
S2/2	2934 ± 123	154 ± 28	3569 ± 136	83 ± 48	5552 ± 394
S2/3	3255 ± 58	86 ± 5	3809 ± 66	---	---
S2/4	3886 ± 146	165 ± 30	4323 ± 154	126 ± 35	7144 ± 266
S3/6	3679 ± 133	218 ± 32	4548 ± 147	116 ± 26	7535 ± 206
S4/7	3625 ± 115	101 ± 11	4107 ± 128	---	---
S4/8	4556 ± 129	204 ± 27	5557 ± 142	161 ± 37	9081 ± 276
S5/3	2631 ± 95	109 ± 12	3188 ± 111	123 ± 38	5062 ± 247
S5/7	2779 ± 111	136 ± 25	3452 ± 123	90 ± 27	6363 ± 230
S6/1	297 ± 20	15 ± 4	395 ± 24	---	---
S6/4	2511 ± 74	124 ± 17	3037 ± 82	78 ± 23	5349 ± 189
S6/6	2764 ± 100	127 ± 22	3315 ± 110	98 ± 33	5657 ± 247
S7/3	2715 ± 128	120 ± 27	3214 ± 139	80 ± 39	5849 ± 208
S7/10	2788 ± 98	76 ± 12	3253 ± 111	---	---

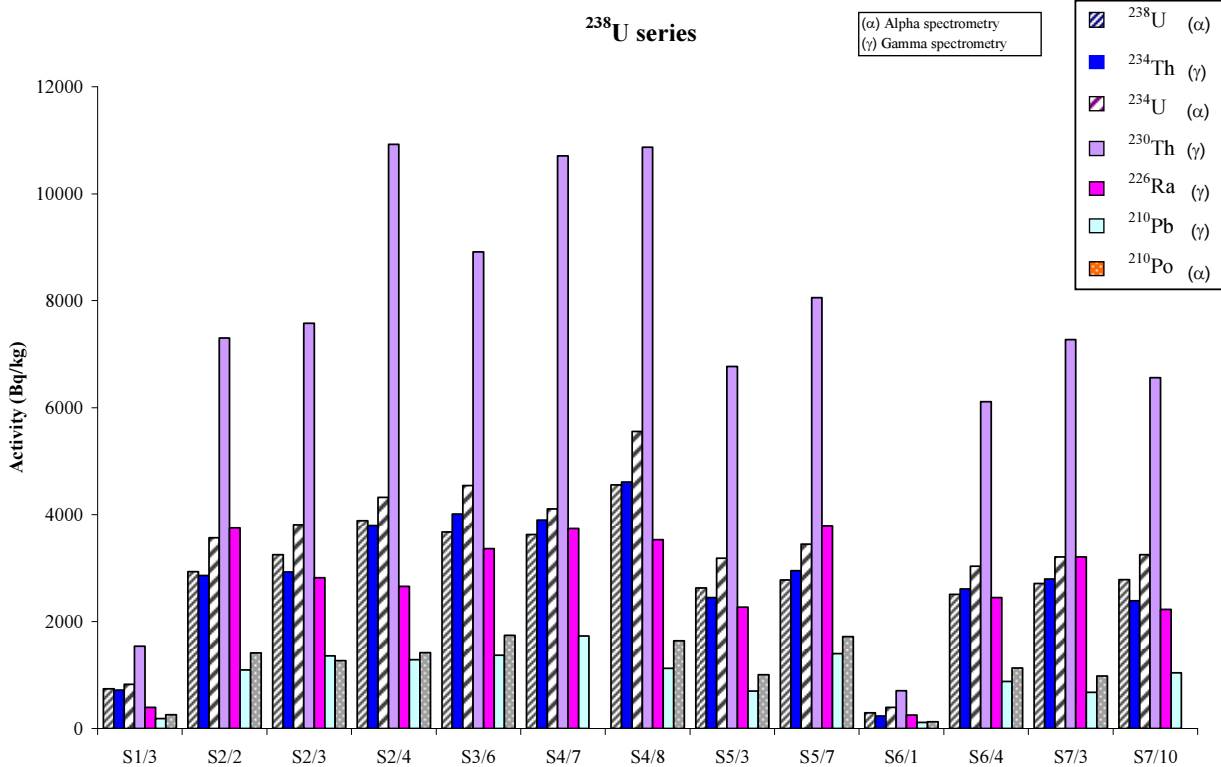

FIG. 2.  $^{238}\text{U}$  decay series radionuclide activity concentrations

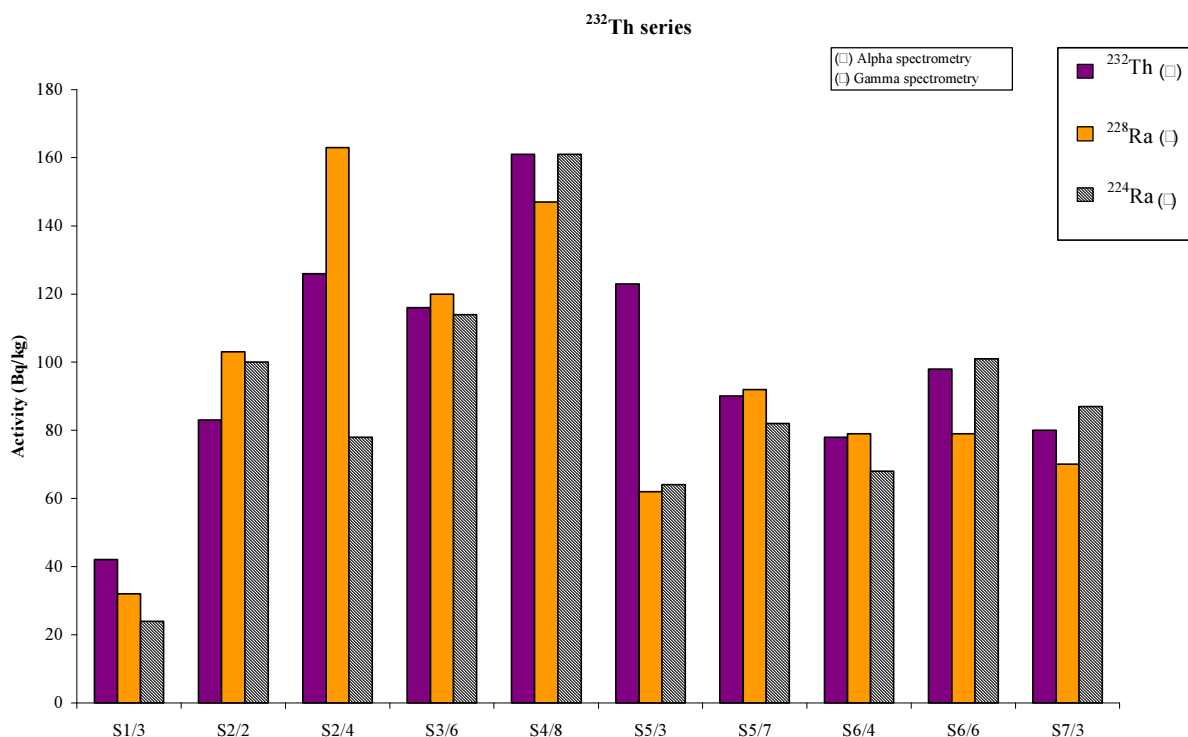

FIG. 3. <sup>232</sup>Th decay series radionuclide activity concentrations

#### 4. Conclusions

High concentrations of radionuclides belonging to the <sup>238</sup>U series were determined in representative mud samples produced in the manufacture of phosphate fertilizers. Non-equilibrium was observed between the activities of the isotopes of the <sup>238</sup>U series. This was especially remarkable for <sup>230</sup>Th, whose activities were higher than 13 000 Bq/kg in some cases. The activities detected for such an isotope were of the order of 2–3 times higher than that of <sup>238</sup>U. The activities of <sup>210</sup>Pb and <sup>210</sup>Po were significantly lower, between 30% and 60% less than that of <sup>238</sup>U.

#### REFERENCES

- Barisic D., Lulic S. and Miletic P (1992). Radium and uranium in phosphate fertilizers and their impact on the radioactivity of waters. *Water Research*, 26, 607-611.
- Bolivar J.P., García-Tenorio R. and García-León M. (1995). Enhancement of natural radioactivity in soils and salt-marshes surrounding a non-nuclear industrial complex. *Sci. Total Environ.*, 173/174, 125-136.
- Bolivar J.P., García-Tenorio R. and García-León M. (1995b). Fluxes and distribution of natural radionuclides in the production and use of fertilizers. *Appl. Radiat. Isot.*, 46, 717-718.
- Bolivar J.P., García-Tenorio R. and Mas J. (1998). Radioactivity of phosphogypsum in the south-west of Spain. *Radiation Protection Dosimetry*, 76(3), 185-189.
- Guimond R.J. and Hardin J.M. (1989). Radioactivity released from phosphate containing fertilizers and from gypsum. *Radiation Physical Chemistry*, 34, 309-315.
- IAEA (2003) Extern of environmental contamination by naturally occurring radioactive material (NORM) and technological options for mitigation. Technical report n°419.
- UNSCEAR (1993). Sources and effects of ionizing radiation. United Nations Scientific Committee on the Effects of Atomic Radiation. Report to the General Assembly with scientific annexes. United Nations, New York, USA.

# Rapid methods for the determination of natural radionuclides in waste waters from a phosphogypsum waste repository site

R. Rusconi, M. Forte, G. Abbate, M.T. Cazzaniga and G. Sgorbati

ARPA Lombardia: Environment Protection Agency of Lombardia  
Milano Department, via Juvara 22, 20129 Milan, Italy

**Abstract.** Gross alpha and beta activity measurements can give useful and quickly available information about the radioactivity content of waste waters. A rapid method based on liquid scintillation counting with alpha/beta discrimination was applied in the framework of a periodical screening of waste waters from a phosphogypsum repository, and for waste waters with high salts content the sensitivity is generally better than that obtained with standard thick source methods.

## 1. Introduction

In the past decades the Italian manufacture of phosphate products from phosphate ore resulted in the production of large quantities of solid wastes, primarily calcium sulphate (commonly known as phosphogypsum), often rich in natural radionuclides. In at least one case the by-product phosphogypsum was stockpiled in a waste repository several hundred hectares in area, near the seashore. Years later, in order to assess the possible radioactive contamination of waste waters originating from stockpiled waste weathering and of underground water from nearby layers, a specific routine monitoring programme had to be defined. The chosen analytical procedures had to be applicable to waters with very low pH values and a high dry residue content (up to 35 g/L), including a variety of cations (especially heavy metals) and phosphate anions. Furthermore, they had to be sufficiently sensitive and rapid.

A commonly used technique is gamma ray spectrometry; nevertheless it presents some shortcomings: large amounts of sample must be heated to dryness by slow evaporation, and the sensitivity is often quite poor. Moreover it does not allow the monitoring of radionuclides lacking direct gamma emissions and which are not in radioactive equilibrium with parent or daughter nuclides, as is often the case in samples containing technologically enhanced amounts of natural radionuclides.

Gross alpha and beta activities are highly useful parameters since they give direct information on overall radioactivity content, as all alpha and beta emissions are effectively measured. The standard measurement methods [1, 2] are based on total counting of dried water residue. Unfortunately they suffer two main drawbacks: the preparation of the sample is time consuming and the sensitivity is very poor when hard water is analysed because the effective amount of water analysed becomes very low.

In recent years liquid scintillation counting (LSC) has been proposed by many authors for rapid measurement of gross alpha and beta activities [3–9], and also our laboratory employed an LSC based method for a wide range screening of northern Italy drinking water [10–11]. The application of this method to waste waters, as can be found close to phosphogypsum repositories, is not straightforward but, nonetheless, it is worth a specific investigation due to its potential usefulness.

## 2. Analytical methods

### 2.1. Gamma ray spectrometry

Samples were first analysed by gamma ray spectrometry. Several litres of water (from 2 to 10 L) were heated to dryness under pH controlled conditions, and an amount of residue corresponding to about 100 mL was inserted in a cylindrical beaker and analysed by gamma ray spectrometry (HPGe detector, 30% relative efficiency, FWHM at 1.33 MeV: 1.78 keV); gamma spectra were analysed using Canberra Genie2k software. The drying procedure took several days; the measuring time was 100 000 s. The activity concentration of  $^{238}\text{U}$  can be derived from the measurement of  $^{234}\text{Th}$  and  $^{234\text{m}}\text{Pa}$ ; the activity concentration of  $^{226}\text{Ra}$  can be inferred from the measurement of  $^{214}\text{Pb}$  and  $^{214}\text{Bi}$ , as

the measurement conditions warrant the existence of radioactive equilibrium between  $^{226}\text{Ra}$  and its short lived daughters.

## 2.2. Gross alpha and beta activity (LSC)

A 20 mL sample was acidified with about 0.1 mL of concentrated nitric acid to  $\text{pH } 1.5 \pm 0.3$  and heated under vigorous stirring in a covered flask for about 15 min to allow radon desorption. 8 mL of acidified sample were then transferred in a Teflon coated polyethylene scintillation vial and 12 mL of scintillation cocktail (Zinsser Quicksafe 400) were added. The sample was counted for 16 h with an ultra-low-level scintillation counter (Quantulus 1220–Perkin Elmer) with an alpha/beta discrimination setup. The counting and calibration procedure is fully described in former papers [10–12].

## 2.3. Other methods employed

Thick source determinations of gross alpha and beta activities were performed by respectively the 9696 and 9697 ISO methods [1, 2]. For alpha counting a zinc sulphide detector was used while for beta counting a plastic scintillation detector was employed.

Uranium isotopes were extracted with a proper scintillation cocktail, containing ethylhexyl orthophosphoric acid, and counted by LSC [10, 13, 14]. Total uranium activity concentration ( $^{234}\text{U} + ^{235}\text{U} + ^{238}\text{U}$ ) was measured. By the use of the commercial spectral analysis program Canberra Genie2k the ratio  $^{234}\text{U}/^{238}\text{U}$  was also determined.

$^{210}\text{Pb}$  was determined by radiochemical separation followed by gross beta counting [15]. A known amount of stable lead was added to the sample and it was then purified by anion resin chromatography and by precipitation first as sulphide and finally as sulphate. Lead sulphate was collected on a paper filter and counted by a low background plastic beta scintillator after the secular equilibrium with the daughter  $^{210}\text{Bi}$  was attained.  $^{210}\text{Po}$  was auto-deposited on a nickel disc from the acidified sample and measured by high resolution alpha spectrometry [15]. An internal standard ( $^{209}\text{Po}$ ) was used in order to determine the chemical yield.

## 3. Results and discussion

The results of the gamma spectrometry measurements are reported in Table I. For the radionuclides of main interest (the uranium isotopes  $^{226}\text{Ra}$ ,  $^{210}\text{Po}$  and  $^{210}\text{Pb}$ ) the information we can gather is quite incomplete because the method sensitivity is poor (this is the case for  $^{210}\text{Pb}$ ,  $^{235}\text{U}$ ,  $^{234}\text{Th}$  and  $^{234\text{m}}\text{Pa}$ ), or because we lack useful gamma emissions (as in the case of  $^{234}\text{U}$  and  $^{210}\text{Po}$ ). The main chemical characteristics of the analysed samples are reported in Table II. In eight out of ten samples the residue exceeded 10 g/L. Two samples had definitely acidic pH values. The reliability of LSC gross alpha and beta measurements were firstly assessed by comparing the results with those obtained with methods ISO 9696 and 9697. The results are reported in Table III. Both for gross alpha and for gross beta, results by LSC and ISO methods agree within the experimental uncertainty (Fig. 1). Furthermore, gross measurements by LSC are consistent with the results of measurements of the single radionuclides (Table IV) contributing respectively to gross alpha and gross beta activities, as shown in Fig. 2. One of the commonly reported shortcomings of LSC counting, i.e. its dependence on quenching, is totally overcome with our experimental procedure: sample quench (measured in our counter by the standard quench parameter (SQP(E)) with the external source method) is constant, as shown in Table III. Another usual shortcoming of liquid scintillation counting, i.e. the chemiluminescence effect, is checked enabling the measurement of delayed coincidences (Fig. 3); furthermore, chemiluminescence signals are limited to the first few keVs and their influence on measured counts can be totally eliminated selecting appropriate counting windows.



TABLE I. RESULTS OF GAMMA RAY SPECTROMETRY MEASUREMENTS (mBq/kg)  
 For values higher than the minimum detectable activity we report in parenthesis the expanded uncertainty (k=2)

Sample	Description	Corresponding amount of water analysed (kg)	Th-234	Pa-234m	Ra-226	Pb-214	Bi-214	Pb-210	U-235	Ac-228	Pb-212	Bi-212	Tl-208	K-40
195	Waste water	1.85	< 408	< 5144	< 527	112 (29)	100 (31)	< 3100	< 32	227 (47)	137 (21)	< 3324	47 (14)	2260 (381)
196	Waste water	2.84	< 328	< 4352	< 513	124 (19)	102 (22)	< 4542	< 31	205 (34)	111 (17)	< 2182	38 (11)	8309 (471)
197	Waste water	2.72	< 266	< 3638	< 418	57 (16)	53 (20)	< 2072	< 25	121 (34)	< 36	< 2136	< 25	2378 (285)
198	Waste water	3.11	< 355	< 3335	< 477	116 (16)	117 (19)	< 3069	< 29	164 (29)	121 (16)	< 1724	49 (13)	7866 (547)
199	Waste water	2.19	654 (185)	< 4318	< 353	< 48	< 50	< 941	< 30	< 132	< 34	< 2599	< 31	3141 (375)
200	Waste water	1.93	12 356 (813)	13 472 (2168)	< 1433	769 (47)	726 (52)	11 900 (2795)	< 751	< 152	< 51	< 3087	< 39	8726 (675)
201	Waste water	3.76	5800 (358)	8283 (1072)	< 297	258 (19)	249 (22)	8199 (1220)	< 363	< 83	< 29	< 1479	< 23	3998 (282)
202	Waste water	4.40	< 117	< 2387	< 292	98 (11)	89 (14)	< 504	< 18	< 51	< 16	< 1311	< 16	6387 (404)
203	Fresh water	9.96	< 101	< 962	< 119	< 16	< 15	< 878	< 7	< 29	< 11	< 535	< 8	485 (70)
204	Spring water	9.97	< 109	< 1139	< 147	< 18	< 19	< 1200	< 9	< 33	< 13	< 602	< 9	521 (77)

TABLE II. CHEMICAL COMPOSITION OF WATER SAMPLES

Sample	Description	Dry residue content (mg/L)	pH	Na (mg/L)	K (mg/L)	Mg (mg/L)	Ca (mg/L)
195	Waste water	14 258	7.2	3317.1	276.9	434.9	453.1
196	Waste water	15 861	7.4	3317.1	276.9	434.9	276.9
197	Waste water	21 075	7.9	5368.4	122.6	738.3	881.6
198	Waste water	11 452	7	2556.9	254.6	335	358.1
199	Waste water	14 932	7	3498.8	119	634.5	923.2
200	Waste water	20 325	2.1	4178.6	403.9	632.8	1325.7
201	Waste water	22 200	1.4	5106.9	276.9	717.4	1381.5
202	Waste water	11 662	6.7	2585.7	244.3	386.8	405.3
203	Fresh water	1436	7.5	239.4	12.8	109.1	219
204	Spring water	676	7.4	122.3	21.2	150	263.6

TABLE III. RESULTS OF GROSS ALPHA AND BETA MEASUREMENTS BY LSC AND BY ISO THICK SOURCE METHODS (mBq/kg)

For values higher than the minimum detectable activity we report in parenthesis the expanded uncertainty ( $k=2$ ). The uncertainty associated with SQP(E) values was derived by repeated measurements of samples at different quench values

Sample Description		LSC				ISO		
		Gross alpha	Gross beta	Corresponding amount of water analyzed (g)	Sample quench (SQP(E))	Gross alpha	Gross beta	Corresponding amount of water analyzed (g)
195	Waste water	705 (177)	1743 (715)	8	778 (4)	< 3400	< 11398	2.93
196	Waste water	314 (117)	7776 (1722)	8	778 (4)	< 987	< 3310	10.08
197	Waste water	289 (114)	3049 (923)	8	777 (4)	< 2363	< 7923	4.21
198	Waste water	< 158	6886 (1569)	8	782 (4)	< 946	4042 (1718)	10.53
199	Waste water	1723 (346)	3919 (1067)	8	780 (4)	2343 (1129)	< 6228	5.36
200	Waste water	43 100 (7500)	37500 (6900)	8	783 (4)	54 261 (3818)	35 261 (5492)	3.79
201	Waste water	30 450 (5298)	14090 (2816)	8	782 (4)	21 437 (2466)	12 302 (4662)	3.91
202	Waste water	< 158	6686 (1535)	8	780 (4)	< 987	4547 (1804)	10.08
203	Fresh water	170 (98)	< 600	8	783 (4)	123 (64)	< 461	72.44
204	Spring water	< 158	< 600	8	791 (4)	182 (35)	352 (89)	213.20

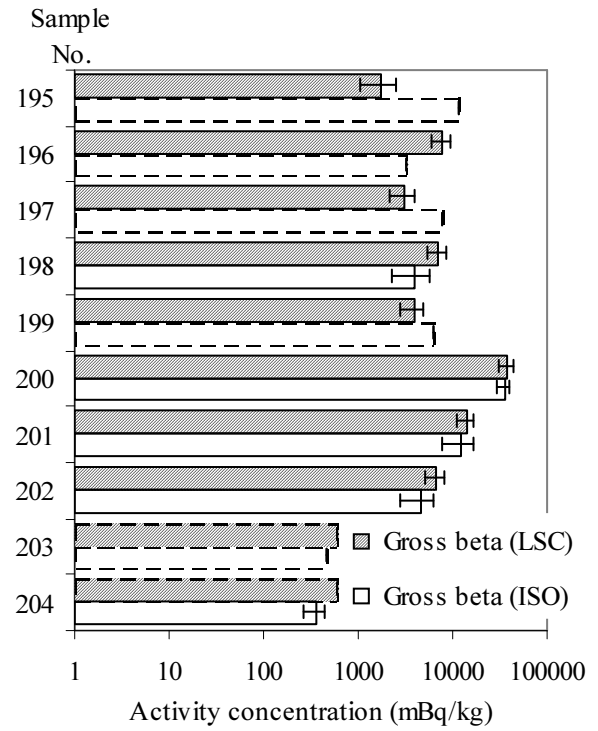
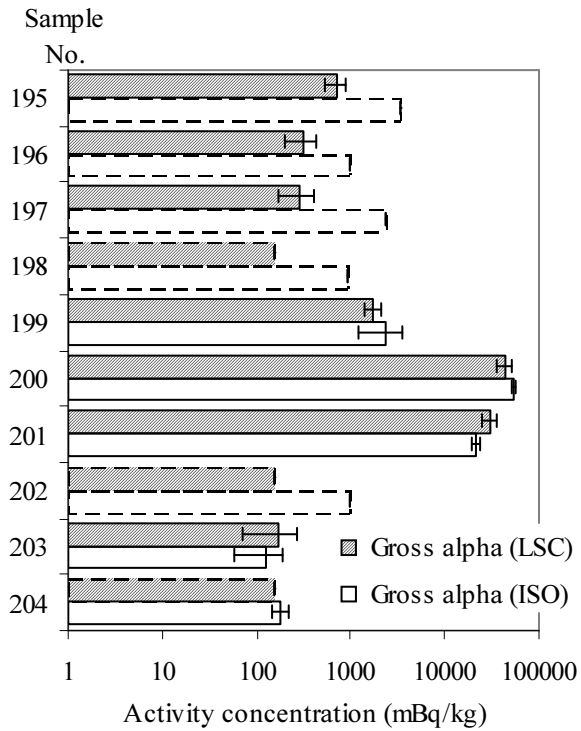

FIG. 1. Comparison of gross activity measurements by LSC and ISO methods. Dashed lines show values lower than the minimum detectable activity

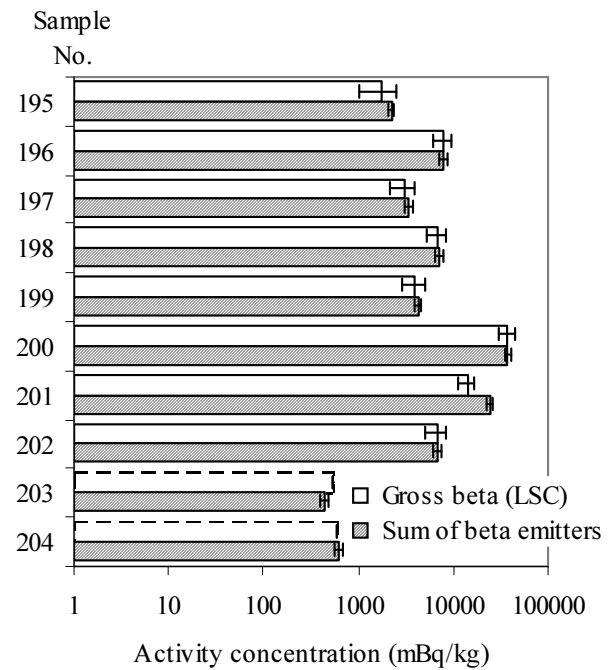
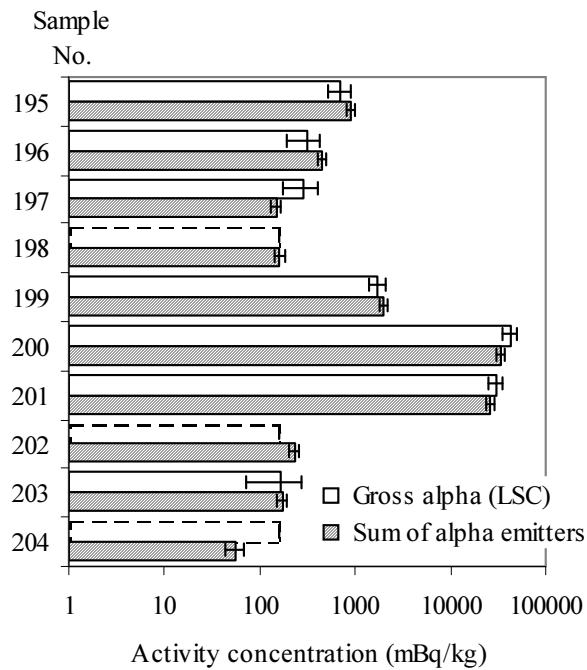

FIG. 2. Comparison of gross alpha (beta) activity measurements and sum of radionuclides contributing to gross alpha (beta) activity. Dashed lines show values lower than the minimum detectable activity

TABLE IV. RESULTS OF URANIUM, Pb-210 AND Po-210 MEASUREMENTS (mBq/kg) For values higher than the minimum detectable activity we report in parenthesis the expanded uncertainty ( $k=2$ ). For Po-210, activity values are referred to the measurement date

Sample	Description	Total uranium	U-234	U-238	Pb-210	Po-210
195	Waste water	769 (87)	452 (40)	316 (40)	< 35	20.4 (7.4)
196	Waste water	307 (37)	n.a.	n.a.	< 33	13.5 (3.8)
197	Waste water	73 (13)	n.a.	n.a.	< 34	18.3 (5.6)
198	Waste water	32.1 (9.0)	n.a.	n.a.	< 53	12.1 (6.2)
199	Waste water	1953 (217)	1045 (119)	908 (104)	< 36	5.6 (4.0)
200	Waste water	29 890 (3270)	15 560 (1710)	14 330 (1570)	12 200 (2000)	3634 (358)
201	Waste water	22 224 (2434)	11 540 (1268)	10 680 (1175)	6000 (1000)	3939 (558)
202	Waste water	88 (14)	n.a.	n.a.	< 31	45 (17)
203	Fresh water	128 (18)	73 (15)	55 (13)	< 31	27.4 (7.8)
204	Spring water	26.8 (8.6)	n.a.	n.a.	< 29	11.6 (5.2)

An appreciable advantage of gross activity measurements by LSC is the possibility of retrieving additional information from the visual inspection and subsequent spectral analysis of gross spectra. Actually, high beta detection efficiency of scintillation counting coupled with the logarithmic analogue-to-digital converter typical of our counter allows the direct measurement of electron emissions as internal conversion electrons; in very contaminated samples, the gross beta spectrum may present a typical electron peak, which can be used to quickly collect information about the radionuclides possibly present. An example is presented in Fig. 3, where the electron peak is due to electrons of lead-210, which emits conversion electrons in K, L, N, O and P shells [16]. Electron detection efficiency is close to 100%, and quantitative analysis of gross beta spectrum with the aid of spectral analysis software for peak area calculation (Canberra Genie2k) gave the results reported in Fig. 4 and in Table V.

The concentration of lead-210 was also measured by gamma spectrometry and by radiochemical separation followed by total beta counting [15]. Values reported in Table V show a good agreement between all reported results.

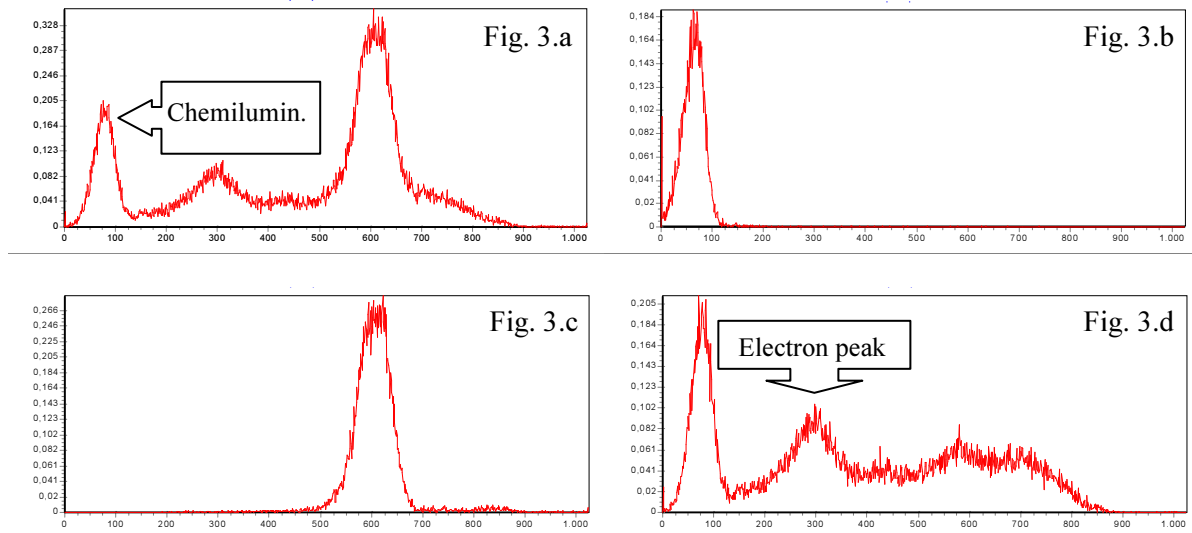

FIG. 3. LSC spectra of sample No. 200. (3.a): total gross alpha+beta spectrum; (3.b): delayed coincidences (chemiluminescence); (3.c): gross alpha component; (3.d): gross beta component.

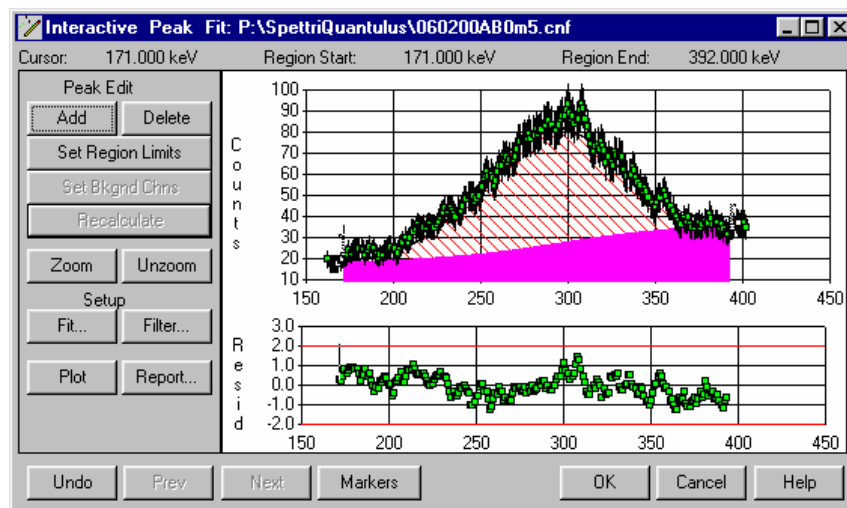

FIG. 4. Peak area calculation of electron peak in gross beta spectrum of sample no. 200

TABLE V. RESULTS OF Pb-210 MEASUREMENTS (mBq/kg)

For values higher than the minimum detectable activity we report in parenthesis the expanded uncertainty (k=2).

Sample	Description	Pb-210, gross beta LSC spectrum	Pb-210, radio- chemical method	Pb-210, gamma spectrometry
200	Waste water	15510 (3160)	12200 (2000)	11900 (2795)
201	Waste water	7120 (1810)	6000 (1000)	8199 (1220)

#### 4. Conclusions

Gamma spectrometry, the most widespread method for radioactivity measurements, gives results only partially satisfactory: sensitivity is often inadequate and information is totally lacking for some of the interesting radionuclides. Moreover, a time consuming process of sample preconcentration is required.

Gross alpha and beta measurement by liquid scintillation counting gives reliable and meaningful results. Method accuracy was tested by comparison with standard ISO methods with completely satisfactory results.

Our method was originally developed for the measurement of drinking waters, and a big effort was devoted to the study of all terms contributing to its accuracy and overall uncertainty [12]. Actually, our approach aims to standardize the characteristics of the sample to be analysed, with special regard to the pH value: under this hypothesis detection efficiencies, background counts and the discrimination device setup are constant as well as alpha and beta spillover, which is also maintained at a very low level (less than a few percent). Problems encountered by many authors who tried to apply LSC-based methods to waste waters are totally overcome, and the method can be reliably applied.

Chemiluminescence, which is unavoidable in the measurement of waste waters very rich in dissolved salts, is continuously monitored and its effect can be disregarded by proper choice of counting windows.

The sensitivity in the measurement of water with a high dry-residue content is definitively better than ISO methods; additional information can be retrieved by the visual analysis of gross spectra, and some information can be inferred about the nature of the main contributors to radioactivity content.

Gross activity measurements by LSC can be successfully applied in periodical monitoring programmes of waters contaminated by NORM, as a valid alternative to the widely used gamma spectrometry.

#### REFERENCES

- [1] INTERNATIONAL ORGANIZATION FOR STANDARDIZATION, Water quality – Measurement of gross alpha activity in non-saline water – Thick source method, ISO 9696, Geneva (1992).
- [2] INTERNATIONAL ORGANIZATION FOR STANDARDIZATION, Water quality – Measurement of gross beta activity in non-saline water, ISO 9697, Geneva (1992).
- [3] SALONEN, L., Simultaneous determination of gross alpha and beta in water by liquid scintillation counting, 2<sup>nd</sup> International Conference on Analytical Chemistry in Nuclear Technology, Karlsruhe (1989).
- [4] SANCHEZ-CABEZA, J.A., et al., Optimisation and calibration of a low-background liquid scintillation counter for the simultaneous determination of alpha and beta emitters in aqueous samples, Radiocarbon (1993) 43–50.
- [5] SANCHEZ-CABEZA, J.A., et al., A rapid method for the simultaneous determination of gross alpha and beta activities in water samples using a low background liquid scintillation counter, Health Phys. **68** (1995) 674–682.
- [6] SURBECK, H., Determination of natural radionuclides in drinking water: a tentative protocol, Sci. Total Environ. **173/174** (1995) 91–99.
- [7] MARTIN SANCHEZ, A., et al., Radioactivity in bottled mineral waters, Appl. Radiat. Isotopes **50** (1999) 1049–1055.
- [8] KLEINSCHMIDT, R.I., Gross alpha and beta activity analysis in water – a routine laboratory method using liquid scintillation analysis, Appl. Radiat. Isotopes **61** (2004) 333–338.

- [9] WONG C.T., et al., Gross alpha/beta analyses in water by liquid scintillation counting, *J. Radioanalyt. Nucl. Chem.* **264** (2005) 357–363.
- [10] FORTE, M., et al., Natural Radionuclide Measurements in Drinking Water by Liquid Scintillation Counting, Methods and Results, *Environmental Chemical Analysis II* (P. WARWICK, ed.), RSC Cambridge (2003) 128–142.
- [11] RUSCONI, R., et al., Natural radioactivity in bottled mineral waters: a survey in northern Italy, *J. Radioanalyt. Nucl. Chem.* **260** (2004) 421–427.
- [12] RUSCONI, R., et al., The evaluation of total uncertainty in low-level LSC measurements of water samples, *Appl. Radiat. Isotopes* **64** (2006) 1124–1129.
- [13] AMERICAN SOCIETY FOR TESTING AND MATERIALS, Standard test method for uranium in drinking water by high resolution alpha liquid scintillation spectrometry, ASTM D 6239–98a (1998).
- [14] FORTE, M., et al., Determination of uranium isotopes in food and environmental samples by different techniques: a comparison, *Radiat. Prot. Dosim.* **97** (2001) 325–328.
- [15] JIA, G., et al.,  $^{210}\text{Pb}$  and  $^{210}\text{Po}$  determination in environmental samples, *Appl. Radiat. Isotopes* **53** (2000) 115–120.
- [16] COMMISSARIAT À L'ÉNERGIE ATOMIQUE, BUREAU NATIONALE DE MÉTROLOGIE, LABORATOIRE DE MÉTROLOGIE DES RAYONNEMENTS IONISANTS, Table de radionucléides, Commissariat à l'Énergie Atomique (1983).



# Extensive radon-222 exhalation measurements in phosphogypsum stacks from south-western Spain using charcoal canisters\*

J.M. Abril<sup>a</sup>, R. García-Tenorio<sup>b</sup>, S. Enamorado<sup>a</sup>, S. Hurtado<sup>b</sup>, I. Vioque<sup>b</sup>, J.Mantero<sup>b</sup>

<sup>a</sup>EUITA, University of Seville,  
Carretera de Utrera km 1,  
E-41013 Seville, Spain

<sup>b</sup>ETSA, University of Seville,  
Avda. Reina Mercedes 4,  
E-41012 Seville, Spain

## 1. Introduction

Phosphogypsum (PG) is a type of NORM generated as a by-product of phosphate fertilizer industries. In south-western Spain some 3000 t of PG are generated annually and disposed of in stacks covering several square kilometres beside the Tinto River and the city of Huelva. There, FERTIBERIA, a fertilizer factory, owns a non-active PG stack of about 1 km<sup>2</sup> and 8–10 m deep, from where PG could be extracted for agricultural uses.

Recent Spanish regulations (R.D. 824/2005, from July 2005) explicitly allow the use of PG as a soil amendment. European regulations (CE 466/2001) establish upper limits for concentrations of some heavy metals (Hg, Cd and Pb) in food. The USEPA has a specific regulation for the agricultural use of PG (64 FR 5574), allowing such use only if the <sup>226</sup>Ra concentration is below 370 Bq/kg, and for monitoring <sup>222</sup>Rn exhalation from PG stacks [1, 2]. For this reason, <sup>222</sup>Rn exhalation has been measured in this stack and PG samples analyzed for radionuclides and heavy metal content.

## 2. Material and methods

Radon-222 exhalation has been measured in this stack using cylindrical charcoal canisters of 10 cm diameter. Three different regions were considered in the stack, following EPA method 115: (1) the compacted and dry top surface area; (2) the loose, tilled, dry top surface and (3) the sides. At each sampling point 3 canisters were systematically placed defining an area of ~1 m<sup>2</sup>. In 4 sampling points each canister was triplicated to study variability on a small spatial scale, and other canisters were used for additional control tests. In total, 162 canisters were placed in 49 points distributed in a 50 m × 75 m mesh (adapted to cover the three regions and distributed in 5 sampling campaigns). After 24 h, the canisters were recovered, sealed, weighed (to determine humidity gain) and transferred to a laboratory. The <sup>222</sup>Rn activity was determined through the  $\gamma$ -emissions of <sup>214</sup>Pb by using low-level gamma-ray spectrometric systems equipped with NaI(Tl) and HPGe (Xtra and ReGe) detectors. These systems were calibrated with charcoal spiked with a tracer solution of <sup>226</sup>Ra, once it was allowed to reach secular equilibrium with <sup>222</sup>Rn.

Experimental studies conducted in collaboration with the Institute of Biophysics from the University of Salzburg demonstrated the repeatability of the charcoal canister method. The accuracy was demonstrated against the exhalation chamber method.

## 3. Results and discussion

The results (corrected by humidity gain) show a high dispersion ( $510 \pm 470$ ,  $250 \pm 270$  and  $360 \pm 170$  Bq h<sup>-1</sup> m<sup>-2</sup> for regions 1, 2 and 3, respectively), but they are under the limit of 2664 Bq h<sup>-1</sup> m<sup>-2</sup> considered in the US-EPA regulation. Canisters placed over big cracks and over freshly removed PG surface did not show any significant increase in Rn exhalation. The standard deviation of normalized

---

\* Work partially supported by the IFAPA (CO-029 project) and ENRESA (I+D contract 0078000044).

(to point or area mean value) Rn exhalation was about 0.5 for all the spatial scales considered (0.1, 0.75, 60 and 200 m). Spatial variability on the scale of 0.1-1.0 m can be attributed to the variability in the same scale of micro- and meso-pore structure. At larger spatial scales, the variability in  $^{222}\text{Rn}$  and humidity concentration, as well as the region conditions, contributes to the variability in Rn exhalation.

PG samples were taken at the surface level (0–20 cm) at 20 sampling points, and at three different depths (0–30 cm, 30–60 cm and 60–90 cm) at another 20 sampling points.  $^{226}\text{Ra}$  was measured by liquid scintillation, providing activity concentrations of  $720 \pm 260$  and  $690 \pm 180 \text{ Bq kg}^{-1}$  (dry weight) for regions 1 and 2, respectively. These values are above the threshold level of  $370 \text{ Bq kg}^{-1}$  established by the USEPA to allow the agricultural use of PG. The  $^{210}\text{Po}$  activity concentrations (measured by alpha spectrometry) were  $660 \pm 160$  and  $575 \pm 95 \text{ Bq kg}^{-1}$  for regions 1 and 2, respectively. Uranium isotopes were measured by alpha spectrometry, giving  $^{238}\text{U}$  activity concentrations of  $170 \pm 110 \text{ Bq kg}^{-1}$  for region 1 and  $160 \pm 80 \text{ Bq kg}^{-1}$  for region 2. The isotopic ratio  $^{238}\text{U} / ^{234}\text{U}$  was  $0.97 \pm 0.03$ , as expected from secular equilibrium. The  $^{210}\text{Pb}$  concentrations were measured by gamma spectrometry in a few samples and were close to the corresponding values of  $^{210}\text{Po}$  activity concentrations. The above activity concentration for  $^{226}\text{Ra}$  and its daughters (and to a lesser extent U isotopes) are more than one order of magnitude higher than those found in agriculture soils from the area of Las Marismas of Lebrija.

Multi-elemental analysis of the PG samples was carried out by the ICP-MS technique following the USEPA 200.8 method [3]. PG samples, after being oven dried, disaggregated and sieved, were acid digested with ultra-pure nitric acid in a microwave oven (pseudo-total recovery). The Cd concentrations were  $2.0 \mu\text{g/g}$ , one order of magnitude higher than those from the agricultural soils of Lebrija. For the rest of the elements considered in the USEPA 200.8 method, the concentrations were not much higher than the corresponding values for soils (Hg was not measured). Thus, taking into account the important dilution of PG when applied as a soil amendment (homogenized in the 0–30 cm soil horizon), the input of these elements can be regarded as negligible.

#### 4. Conclusions

This work demonstrated that  $^{222}\text{Rn}$  exhalation rates in the FERTIBERIA PG stack ( $510 \pm 470$ ,  $250 \pm 270$  and  $360 \pm 170 \text{ Bq h}^{-1} \text{ m}^{-2}$  for regions 1, 2, and 3, respectively) were under the USEPA limit of  $2664 \text{ Bq h}^{-1} \text{ m}^{-2}$ .

Cd and radionuclides from the  $^{238}\text{U}$  series will be the main elements of concern in the agricultural use of PG from the FERTIBERIA stack.

#### REFERENCES

- [1] UNITED STATES ENVIRONMENTAL PROTECTION AGENCY, Monitoring for Radon-222 Emissions, 40 CFR Part 61, Appendix B, Method 115, USEPA, Washington, D.C., [www.epa.gov](http://www.epa.gov).
- [2] UNITED STATES ENVIRONMENTAL PROTECTION AGENCY, Potential uses of phosphogypsum and associated risks, Background information document for 40 CFR 61 Subpart R, National Emission Standards for Radon Emissions from PG Stacks, 402-R92-002, USEPA, Washington, D.C. (1992).
- [3] UNITED STATES ENVIRONMENTAL PROTECTION AGENCY Determination of Trace Elements in Waters and Wastes by Inductively Coupled Plasma — Mass Spectrometry, Method 200.8, USEPA, Washington, D.C., [www.epa.gov](http://www.epa.gov).

# Radium-226 transfer factors for various crop samples collected in Japan

K. Tagami, S. Uchida

Office of Biospheric Assessment for Waste Disposal  
National Institute of Radiological Sciences  
Chiba, Japan

**Abstract.** The soil-to-plant transfer factor (TF) is a key parameter that directly affects the internal dose assessment for the ingestion pathway of radionuclides. We measured the concentrations of  $^{226}\text{Ra}$  in crops and associated soils collected from 80 fields throughout Japan in order to obtain their TFs. The radioactivity of  $^{226}\text{Ra}$  was measured with a Ge detector system for soil samples and a liquid scintillation counting system for crop samples after radiochemical separation. We also measured concentrations of Ca, Sr and Ba which are in the same alkaline earth metal group for comparison. Radiochemical separation was used for crop samples, but due to low concentrations, 9 upland field crop samples and 9 brown rice samples could not be measured. Using the 68 measured data, we calculated TFs (dry weight basis); the geometric means of the TFs were  $5.7\text{E-}4$  for brown rice ( $n=28$ ) and  $1.2\text{E-}2$  for green vegetables ( $n=12$ ). TFs of Ca, Sr and Ba were similar to TF-Ra.

## 1. Introduction

Radium-226, an alpha emitter with a half-life of about 1600 a, is a natural decay product of U-238; both U and Ra-226 can be found in phosphatic fertilizers. Ra can reach humans through several transfer paths in the environment. Once Ra is taken into the human body by ingestion of food and water or inhalation, it can distribute into the bones where it has a long biological half-life; exposure to Ra can cause cancers and other body disorders. Thus, knowledge on its uptake from soil to crops is important.

In order to understand the fate of Ra in soil-crop systems, the soil-to-crop transfer factor (TF) is used. It is defined as the ratio of activity concentration in plant to activity concentration in soil on dry weight basis. TFs of Ra for several crops were included in Technical Report Series No. 364 (TRS-364) compiled by the IAEA [1], but these data were obtained mainly from crops grown in Europe and North America. TFs for crops native to Japan are severely under-reported. There are some TF-Ra data in Japan [2, 3] but the data were obtained from only a few places, thus, it would be better to collect TFs of Ra nationwide.

In this study, we collected crops and associated soil samples from 80 fields throughout Japan and measured their  $^{226}\text{Ra}$  concentrations. We also measured Ca, Sr and Ba concentrations to allow comparison of their behavior with that of Ra.

## 2. Experimental

### 2.1. Sample collection

Surface layer (0–20 cm) soil samples from paddy field and upland fields were collected nationwide from 37 and 43 sampling sites, respectively, in 2002–2004 during the harvesting season. These samples were air dried and passed through a 2 mm mesh sieve before being thoroughly ground into a fine powder (pre-treatment).

Edible crop parts were also collected for 13 green vegetable samples, 9 tuber samples, 7 allium species

samples, 7 fruit vegetable samples, 4 root vegetable samples and 5 cereal samples grown in upland fields (total: 49 crop part samples). For leek, the green and white parts were separated as individual samples. Leaves of Japanese radish are also edible parts, so the roots and leaves were separated and the elemental compositions of both were measured. Thirty-five brown rice samples were collected from paddy fields.

## 2.2. Radium-226 measurements

For the soil samples, about 60 g of each pre-treated soil sample were charged and sealed into a plastic vessel. These samples were kept at room temperature for more than 30 days to reach an equilibrium condition with progeny nuclides of  $^{226}\text{Ra}$ , that is,  $^{222}\text{Rn}$ ,  $^{218}\text{Po}$ ,  $^{214}\text{Pb}$ , and  $^{214}\text{Bi}$ . Then, the concentration of  $^{214}\text{Pb}$  was measured with a Ge detector system (Seiko EG&G Ortec) from which  $^{226}\text{Ra}$  could be calculated.

For crop samples, a chemical separation was carried out using about 15 g of each incinerated crop sample ( $450^\circ\text{C}$ , 24 h). The use of 5 g of incinerated crop has been recommended for the standard method used in Japan [4], but we tripled the sample amount. The chemical yield of Ra was obtained using Ba and a value of more than 97% was observed.

## 3. Results and discussion

### 3.1. Radium-226 concentrations in soil and crop samples

The concentrations of  $^{226}\text{Ra}$  in upland soil samples ranged from 13.9 to 60.3  $\text{Bq kg}^{-1}$  dry wt (geometric mean: 30.6  $\text{Bq kg}^{-1}$  dry wt), and those in paddy field soil samples ranged from 16.9 to 64.9  $\text{Bq kg}^{-1}$  dry wt (geometric mean: 33.9  $\text{Bq kg}^{-1}$  dry wt). No difference was observed between the land uses as, shown in Fig. 1. The concentrations ranged from 0.039 to 1.72  $\text{Bq kg}^{-1}$  dry wt for upland field crop samples and 0.008 to 0.064  $\text{Bq kg}^{-1}$  dry wt for brown rice samples.

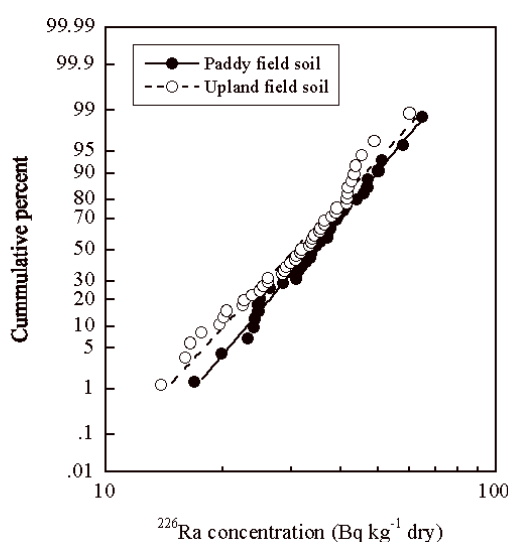

FIG.1. Probability distributions of  $^{226}\text{Ra}$  in paddy field soil and upland field soil samples collected in Japan.

Since  $^{226}\text{Ra}$  is included in phosphatic fertilizers [5, 6], in our previous study [7], we estimated the excess amount of  $^{226}\text{Ra}$  due to addition of these fertilizers. The geometric mean value was about  $15 \text{ Bq kg}^{-1}$  dry wt. From the results, it was implied that a half of the total  $^{226}\text{Ra}$  in agricultural soils in Japan was from phosphatic fertilizers.

### 3.2. Transfer factor (TF)

The TF of  $^{226}\text{Ra}$  was then calculated using concentration data from soil and crop samples. The TF is defined as

$$\text{TF} = \frac{\text{Element concentration in the edible parts at harvest (Bq kg}^{-1} \text{ or mg kg}^{-1} \text{ dry wt)}}{\text{Element concentration in the soil (Bq kg}^{-1} \text{ or mg kg}^{-1} \text{ dry wt)}}$$

The geometric means of  $^{226}\text{Ra}$ , Ca, Sr and Ba for 7 crop types are listed in Table I. For  $^{226}\text{Ra}$ , although we used radiochemical separation for crops, due to the low concentrations, 9 upland field crop samples and 9 brown rice samples could not be measured. Green vegetables showed the highest TFs for Ca, Sr and  $^{226}\text{Ra}$  and the second highest for Ba, while brown rice showed the lowest TFs for all the elements. Among the elements, Ca showed the highest TFs for all crops possibly because it is essential for plants.

TABLE I. TFs OF Ca, Sr, Ba AND  $^{226}\text{Ra}$  FOR 7 CROP TYPES COLLECTED IN JAPAN

	Ca		Sr		Ba		$^{226}\text{Ra}$	
	n	TF	n	TF	n	TF	n	TF
Green vegetables	13	6.2E-1	13	2.3E-1	13	3.0E-2	12	1.2E-2
Allium species	11	2.9E-1	11	1.3E-1	11	1.8E-2	9	1.1E-2
Root vegetables	4	3.8E-1	4	2.0E-1	4	4.4E-2	4	1.2E-2
Tubers	9	3.8E-2	9	2.2E-2	9	4.0E-3	8	2.0E-3
Fruit vegetables	7	1.6E-1	7	3.1E-2	7	3.3E-3	3	3.7E-3
Wheat and barley	5	2.0E-2	5	1.6E-2	5	9.8E-3	4	2.7E-3
Brown rice	37	8.9E-3	35	3.0E-3	37	1.8E-3	28	5.7E-4

The TFs obtained for  $^{226}\text{Ra}$  were then compared with previous results. Data listed in TRS-364 [1] were almost the same order of magnitude as in this study for corresponding crops. From the results of Yunoki et al. [2], we calculated dry weight basis TFs and the values for green vegetables were from  $9.6\text{E-}3$  to  $2.0\text{E-}2$ . Sasaki et al. [3] also measured TFs of  $^{226}\text{Ra}$  but the concentrations in their upland field crop samples were lower than the detection limit, and their brown rice result was  $4.7\text{E-}3$ , which is one order of magnitude higher than our results but close to the TFs of wheat and barley. Recently, Sheppard *et al.* [8] revised TFs of Ra and reported values for vegetables, root crops and cereal grains of  $2\text{E-}2$ ,  $1.8\text{E-}2$  and  $3\text{E-}2$ , respectively. These revised crop results are 2 orders of magnitude higher than our present results and also 1 order of magnitude higher than previous results [1, 3]. If these revised TFs included many data obtained by radiotracer experiments then the results would be higher

than those in field observation studies, possibly due to the aging effect of the soil samples. Freshly added radiotracers are usually in mobile forms such as water soluble and ion exchangeable forms, while stable elements in soil have various physico-chemical forms such as organically-bound and specifically adsorbed forms and, frequently, they are occluded in weathering-resistant particles. Thus, after addition of the phosphatic fertilizers,  $^{226}\text{Ra}$  in fertilizer would show higher TFs than native Ra, and then the TF values of  $^{226}\text{Ra}$  from the fertilizers would decrease with time.

Correlations between TFs of  $^{226}\text{Ra}$  and those of Ca, Sr and Ba are plotted in Fig. 2 using the data listed in Table I. The TFs of  $^{226}\text{Ra}$  showed a good correlation (t-test:  $p < 0.01$ ) with coefficients of more than 0.9. Thus, under agricultural environment conditions, the TFs of these elements would also be good analogues of TF-Ra. However it should be noted that the regression curve did not have a 1:1 slope possibly due to physical and chemical differences between Ra and Ca, Sr and Ba. In order to estimate TF-Ra using Ca, Sr and Ba data, further studies are needed.

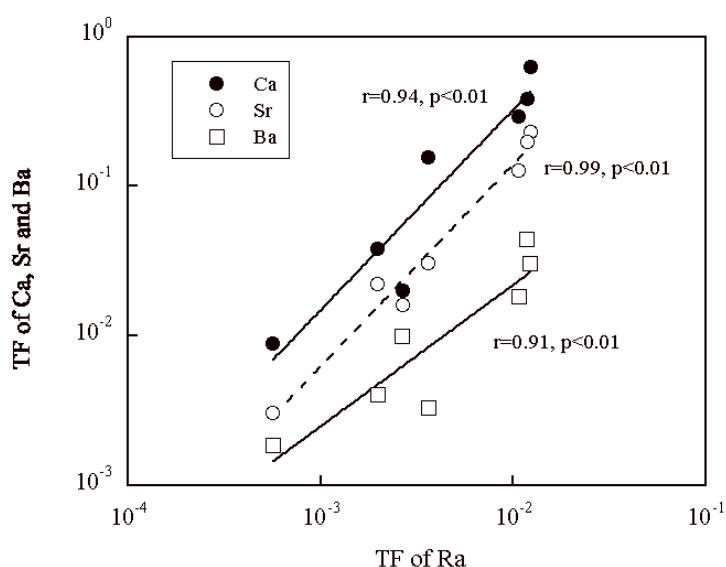

FIG. 2. Correlations between TFs of  $^{226}\text{Ra}$  and TFs of Ca, Sr and Ba.

#### ACKNOWLEDGEMENT

This work has been partially supported by the Agency for Natural Resources and Energy, the Ministry of Economy, Trade and Industry (METI), Japan.

#### REFERENCES

- [1] INTERNATIONAL ATOMIC ENERGY AGENCY, Handbook of Parameter Values for the Prediction of Radionuclide Transfer in Temperate Environments, Technical Reports Series No. 364. IAEA, Vienna (1994).
- [2] YUNOKI, E., et al., Activity concentrations of  $^{238}\text{U}$  and  $^{226}\text{Ra}$  in agricultural samples, Radioanal. Nucl. Chem. **174** (1993) 223.

- [3] SASAKI, T., et al., Determination of transfer factors of uranium, thorium, radium and lead from soil to agricultural product in Japan for estimating internal radiation dose through ingestion, *Japanese Journal of Health Physics* **37** (2002) 208 (abstract in English).
- [4] MINISTRY OF EDUCATION, CULTURE, SPORTS, SCIENCE AND TECHNOLOGY, JAPAN, Analytical Methods for the Determination of Radium, Standard Radioactivity Analysis and Measurement Methods, Manuals Series No. 19, MEXT, Tokyo (1990) (in Japanese).
- [5] HAMAMO, H., et al., Studies of radioactivity and heavy metals in phosphate fertilizer, *J. Radioanal. Nucl. Chem.* **194** (1995) 331.
- [6] MAKWEBA, M.M., HOLM, E., The natural radioactivity of the rock phosphates, phosphatic products and their environmental implications, *Sci. Total. Environ.* **133** (1993).
- [7] UCHIDA, S., TAGAMI, K., Soil-to-crop transfer factors of radium in Japanese agricultural fields, *J. Nucl. Radiochem. Sci.* (in press)
- [8] SHEPPARD, S.C., et al., Revision and meta-analysis of selected biosphere parameter values for chlorine, iodine, neptunium, radium, radon and uranium, *J. Environ. Radioactivity* **89** (2006) 115.





# Identification of technogenic contamination by natural radionuclides

I.V. Yarmoshenko, A.A. Ekidin, M.V. Zhukovsky, A.D. Onischenko

Institute of Industrial Ecology UB RAS  
Ekaterinburg, Russian Federation

**Abstract.** Elaborated approach on identification of low level environmental contamination by TENORM consists of investigation of ratio between activities of radionuclides from different natural radioactive series as well as ratio of these radionuclides to  $^{40}\text{K}$  (radionuclide ratio). Approach includes investigation of correlation of  $^{226}\text{Ra}$ ,  $^{232}\text{Th}$  and  $^{40}\text{K}$  activity concentrations in environmental samples of common genesis. Distortion of naturally formed radionuclide ratio is considered as an evidence of contamination. The soil contamination investigation using the approach based on radionuclide ratio analysis was performed at site of oil producing company and thorium monazite storage facility.

## 1. Introduction

Increasing attention to the naturally occurring radionuclides is based on recognition of the natural and technologically enhanced radiation sources as primary factors of population exposure. Radiation protection in relation to the use of radioactive raw material is considered to be an important problem of natural radionuclides radioecology. Even at low activity concentration of raw material the drastic enhancement of natural radionuclides in some products or wastes can appear as a result of technological processes. Unregulated radioactive wastes disposal and radiation incidents at radioactive material processing sites result in technogenic contamination of environment by natural radionuclides. Though investigations of environmental distribution and migration of natural radionuclides rapidly develops during last years a number of issues of natural radionuclides radioecology remain uncertain and poorly studied. Among other the task could be noted that concerns to identification of environment contamination by technologically enhanced natural radioactive materials (TENORM) under condition of its substantial background content.

In order to evaluate the problem at an early stage including the contamination source determination and migration routes predicting the identification of low level technogenic contamination is necessary. Frequently used approach to treat the field data of TENORM contamination survey consists of comparison of the results with some accepted regulatory level. Such approach allows the identification only at a late stage of accidental situation when the considerable contamination level can appear either as a result of strong accidental discharge or due to long term migration and accumulation. In some cases the disequilibrium in uranium or thorium radioactive series is efficient indicator of the low level environmental TENORM contamination. The essential disequilibrium is specific characteristic of some TENORM bearing wastes and can appear in a number of thermal and chemical technological processes. However the disequilibrium apparently is not a common feature of NORM involving processes and technologies and disequilibrium investigation does not cover all range of possible accidental scenarios involving naturally occurring radionuclides. Another disadvantage of the disequilibrium investigation is necessity of simultaneous measurements of inherent activity concentration of several radionuclides from a radioactive family. Quite expensive high resolution spectrometry techniques or additional analytical measurements methods have to be applied to determine content of some radionuclides (especially parent isotopes  $^{238}\text{U}$  and  $^{232}\text{Th}$ ).

Thus approaches mentioned above do not provide a reliable general indicator of TENORM environmental contamination, especially at low level concentration of natural radionuclides. In our opinion the application and future development of the radionuclide ratio investigation approach is useful in relation to the problem of TENORM contamination identification.

## 2. Background and basic methodology of radionuclide ratio investigation approach

Radionuclide ratio is determined as activity concentrations ratio of two radionuclides in the sample of environmental object. If isotopes of the same radionuclide are considered then the ratio of activity

concentrations represents the isotopic ratio. Studying the radionuclide ratio in the natural and technogenic objects it is necessary to take into account the fractionation of different elements in the environment. Environmental separation of isotopes is more rarely a phenomenon, it can appear for example due to difference of decay constants. Radionuclide and isotopic ratio analysis is successfully applied in different sciences. Isotopic chronology is important technique of geosciences and archeology. In the radioecology of man-made radionuclides the radionuclide and isotopic ratio are used to identify the source of contamination.

Suggested application of radionuclide ratio approach in radioecology of natural radionuclides and TENORM environmental contamination studies is based on assumption on directly proportional dependencies between radionuclides of natural uranium and thorium families as well as radioactive potassium ( $^{40}\text{K}$ ) in natural objects of common genesis. Consequently the constant value of radionuclide ratio is assumed for uncontaminated environmental samples. Objects such as soils, natural waters, sediments within a local area could be considered as such natural objects of common genesis. In particular soil constituting rocks directly relate to bed-rocks and succeed proportionally the concentrations of natural radionuclides under similar physical and chemical conditions of soil formation. Additional technogenic release of natural radionuclides to the environment due to NORM processing activity results in both quantitative and relative increasing of contamination radionuclide concentration and distortion of the naturally formed radionuclide ratio. It is important that detectable radionuclide ratio distortion occurs even at low level technogenic contamination.

For the purposes of the radiation environmental studies in the areas of influence of NORM processing facilities the radionuclide ratio analysis can be restricted to consideration of activity concentration ratios  $^{226}\text{Ra}/^{232}\text{Th}$ ,  $^{226}\text{Ra}/^{40}\text{K}$  and  $^{232}\text{Th}/^{40}\text{K}$ . In some cases daughter radionuclides can be used instead of the parents  $^{226}\text{Ra}$  and  $^{232}\text{Th}$ . Measurements of the concentration activity of these radionuclides in the environmental objects are typical charge of the regular radiation safety department and do not require expensive high resolution spectrometry equipment. Essential feature of radionuclide ratio investigation in radioecology of natural radionuclides is the opportunity to analyze relationship between three elements (radionuclides of uranium and thorium series and  $^{40}\text{K}$ ) which provide three independent values of radionuclide ratio. Distortion of two radionuclide ratios together with stability of a remaining one is necessary criterion to make a conclusion on technogenic contamination by radionuclides of one series or  $^{40}\text{K}$ .

In order to apply the radionuclide ratio investigation approach it is necessary to determine the undistorted radionuclide ratio value and its distribution parameters for the object under study (soil, sediments etc.). Preferably necessary characteristics have to be estimated using results of radiation measurements of the samples that are believed to be uncontaminated. Practically uncontaminated samples can be gathered either in distance from contamination source or aside from migration routes. In this case it is necessary to control the adequacy of the type and genesis of the samples to the studied object. When new NORM processing site is projected the representative sampling of uncontaminated environmental objects could be performed before starting of technological processes. Additionally to estimate expected undistorted radionuclide ratio value the known data for similar objects obtained for other sites can be considered. Generally the contamination of the samples can be uncertain that requires a more complicated data analysis.

### **3. Examples of TENORM contamination identification using radionuclide ratio investigation**

The suggested approach to identification of technogenic contamination by natural radionuclides was applied to analyze the results of TENORM survey performed at two NORM processing sites such as follow:

- (a) Site of oil producing company. The TENORM contamination of processing equipment and elevated concentration of  $^{226}\text{Ra}$  in wastes of oil producing industry is a widely recognized problem. The samples of soils were gathered at a several oil producing sites of the company. Soil samples with visible traces of oil contamination and those gathered at the probable

migration routes were considered as possibly TENORM contaminated. Oil clean samples aside from ephemeral water streams were used to evaluate the undistorted radionuclide ratio.

- (b) Site of monazite concentrate storage facility. Concentration activity of  $^{232}\text{Th}$  in the monazite concentrate is as high as 200 Bq/g. Some contamination of the site by monazite can appear in the past during loading and repackaging operations. All soils samples taken at the storage facility were considered as uncertainly contaminated. The samples of the same type believed uncontaminated were not available.

All samples were analyzed using high resolution gamma spectrometer with Ge detector. The activity concentration of  $^{232}\text{Th}$ ,  $^{226}\text{Ra}$  and the progeny as well as  $^{40}\text{K}$  were estimated basing on their own spectral lines.

A useful starting point to analyse the radionuclide ratio is plotting the dependency of radionuclide activity concentrations obtained for all samples (uncontaminated, contaminated and uncertain). Figs 1 and 2 present the obtained dependencies  $^{232}\text{Th}$  vs  $^{226}\text{Ra}$ ,  $^{232}\text{Th}$  vs  $^{40}\text{K}$  and  $^{226}\text{Ra}$  vs  $^{40}\text{K}$  for oil producing sites and thorium monazite storage site respectively. Under condition of lognormal distribution of natural radionuclide activity concentrations in soil samples, the natural logarithmic scales are used to create the scatter plots. At a first stage even a simple visual analysis of the scatter plot allows preliminary recognition of contaminated and uncontaminated samples. As can be seen in Figs 1 and 2 while most of data are normally distributed along the lines that characterize naturally formed relationship (light points), some points randomly deviate from this 'cloud' of data (dark points). Such deviation arose for some uncertain samples due to increased concentration of  $^{226}\text{Ra}$  for oil producing sites and  $^{232}\text{Th}$  for thorium monazite storage facility. At the same time the scatter plots  $^{232}\text{Th}$  vs  $^{40}\text{K}$  for oil producing sites and  $^{226}\text{Ra}$  vs  $^{40}\text{K}$  for thorium monazite storage facility do not demonstrate visible deviation from binary lognormal distribution. So visual analysis allows preliminary conclusion on contamination of some soil samples by  $^{226}\text{Ra}$  at oil producing sites and by  $^{232}\text{Th}$  at site of monazite concentrate storage facility.

In order to validate the conclusion on TENORM contamination the value of undistorted radionuclide ratio and its confidence interval were estimated. We made necessary estimations using correlation statistics and searched for parameters of linear regression function:

$$C_1 = b \cdot C_2 \quad (1)$$

where

$C_1$  and  $C_2$  are natural radionuclides activity concentrations  
 $b$  is slope factor of linear function.

In order to meet the requirements of lognormal distributions the estimation of  $b$  was performed using  $\ln(C_1)$  and  $\ln(C_2)$ . Average value and variation of slope factor  $b$  are equivalent to such parameters of radionuclide ratio. In the case of oil production the radiation measurements data of uncontaminated soil samples are included in the estimations. For monazite storage facility, where presumably uncontaminated samples were not found, the data treatment uses the preliminary assumption that only few data are contaminated that is based on the results the scatter plots visual analysis. If most of data is recognized uncontaminated the relationship of activity concentrations modal values is close estimate of undistorted radionuclide ratio. Using inverse value of the deviations of actual radionuclide ratios from this relationship as weighting factor the average values and confidence intervals for characteristic undistorted radionuclide ratios were estimated in this case as well. Results of estimation of undistorted radionuclide ratio are presented in the Table I.

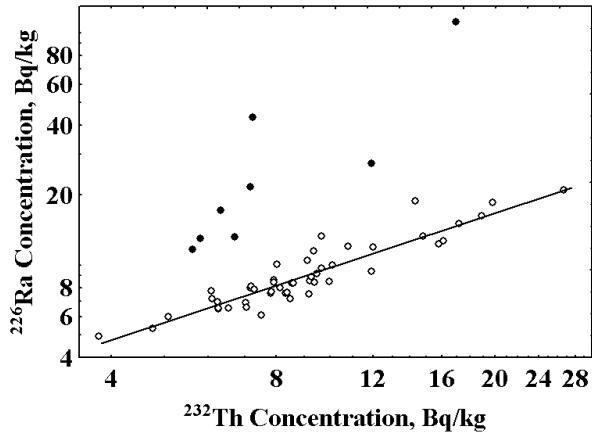

(a)

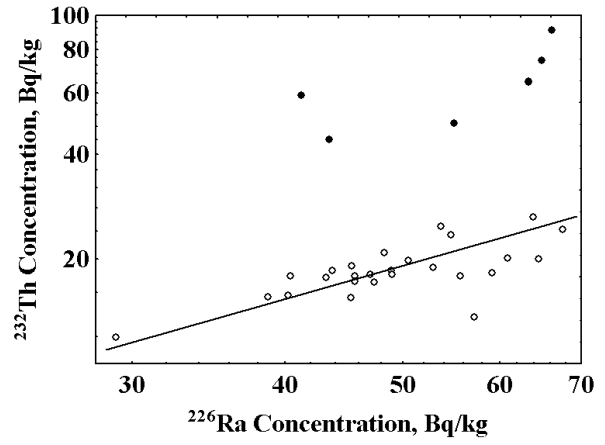

(a)

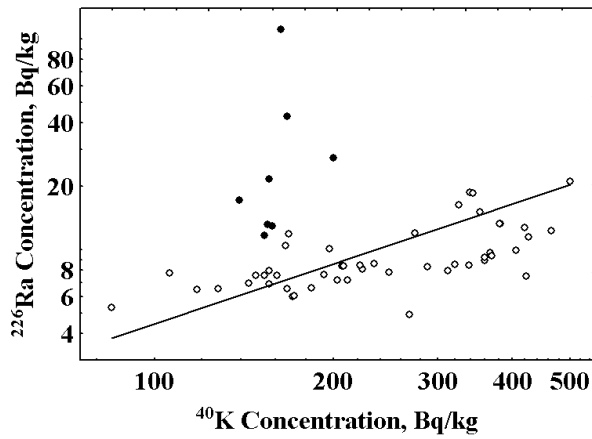

(b)

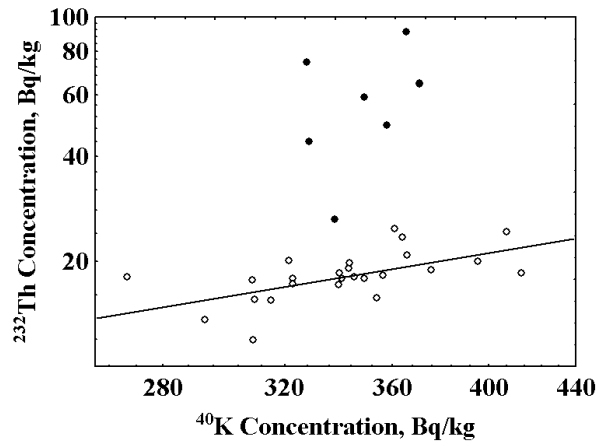

(b)

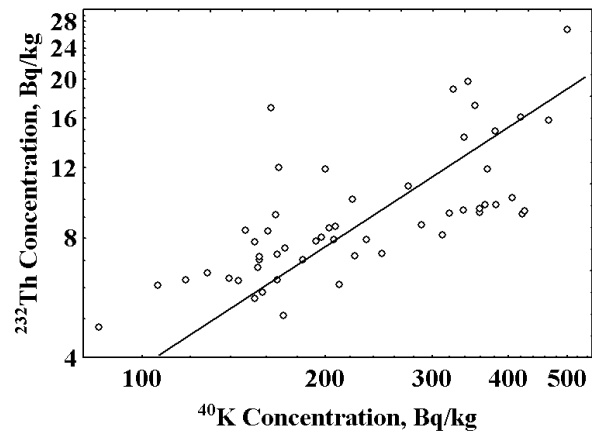

(c)

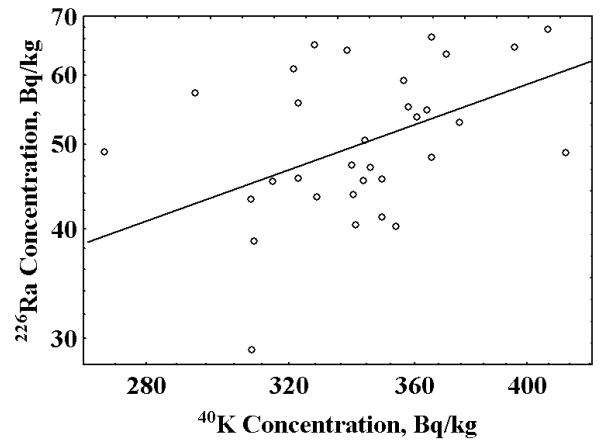

(c)

Fig. 1. Dependency of radionuclides' activity concentrations at oil producing sites.

(a)  $^{232}\text{Th}$  vs.  $^{226}\text{Ra}$ ;

(b)  $^{40}\text{K}$  vs.  $^{226}\text{Ra}$ ;

(c)  $^{40}\text{K}$  vs.  $^{232}\text{Th}$ .

Fig. 2. Dependency of radionuclides' activity concentrations at monazite storage site.

(a)  $^{226}\text{Ra}$  vs.  $^{232}\text{Th}$ ;

(b)  $^{40}\text{K}$  vs.  $^{226}\text{Ra}$ ;

(c)  $^{40}\text{K}$  vs.  $^{232}\text{Th}$ .

TABLE I. RESULTS OF ESTIMATION OF UNDISTORTED RADIONUCLIDE RATIO

	Radionuclides	R <sup>2</sup>	Radionuclide ratio with 99% confidence interval
Oil producing site	<sup>226</sup> Ra – <sup>232</sup> Th	0.83	1.1 ± 0.3
	<sup>226</sup> Ra – <sup>40</sup> K	0.55	0.041 ± 0.027
	<sup>232</sup> Th – <sup>40</sup> K	0.2	0.039 ± 0.034
Monazite storage site	<sup>232</sup> Th – <sup>226</sup> Ra	0.67	0.38 ± 0.11
	<sup>232</sup> Th – <sup>40</sup> K	0.34	0.052 ± 0.017
	<sup>226</sup> Ra – <sup>40</sup> K	0.12	0.15 ± 0.07

Final stage of analysis includes comparison of actual radionuclide ratios obtained for each sample with estimated confidence interval of the naturally formed radionuclide ratio (Table I). Significant distortion demonstrated for two radionuclide ratios out of three confirms the conclusion on TENORM contamination of a sample.

Out of 49 uncertain samples gathered at oil producing company sites, 8 were found to be contaminated by <sup>226</sup>Ra. Additional contamination does not exceed 92 Bq/kg. Significant disequilibrium between <sup>238</sup>U and <sup>226</sup>Ra detected for these samples confirms the conclusion on contamination. Further analysis of spatial distribution of contaminated and uncontaminated samples has shown that the problem of TENORM contamination occurs at east oil producing sites of the company.

Contamination of soil by <sup>232</sup>Th at the site of monazite storage facility was determined for 6 samples out 32 gathered. Additional contamination in this case is in the range 27–70 Bq/kg. The contaminated points are randomly distributed over the studied site. It was supposed that the contamination spots developed due to occasional spill during loading and repackaging operations. Using sample characteristics of contamination the total mass of monazite spills over the storage facility site is estimated at about 500 kg.

#### 4. Conclusion

Analysis of radionuclide ratio in the environment objects of sites influenced by NORM processing facilities represents the efficient and almost universal approach to identification of radioactive contamination. Essential advantages of the radionuclide ratio analysis in comparison with other methods are as follows:

- (a) Ability to make reliable conclusions even at relatively low level of TENORM environmental discharge;
- (b) Opportunity to search for TENORM migration at early stage of contamination;
- (c) Utilization of most available radiation measurement techniques;
- (d) Analysis results provide appropriate data to further analyse characteristics of contamination.

# Radon levels at a NORM storage site

L.S. Caccuri, M.P. Campos

Institute of Energy and Nuclear Research (IPEN)  
São Paulo, Brazil

**Abstract.** At the Instituto de Pesquisas Energéticas e Nucleares (IPEN), São Paulo, Brazil, there is a facility dealing with high uranium and thorium concentrations, the nuclear materials storage site. In order to estimate afterwards the effective committed dose for workers due to radon inhalation, the radon concentrations were assessed through the passive method with SSNTD (Makrofol E) at the site. The radon concentration results, covering the period December 2004 to September 2006, varied from  $648 \pm 42$  to  $1227 \pm 505$  Bq/m<sup>3</sup>.

## 1. Introduction

It is well known that NORM (naturally occurring radioactive material) is hazardous to health and it has long been recognized that work with NORM can raise significantly the exposure in the workforce [1, 2]. There are two types of NORM waste: discrete and diffuse. The first, discrete NORM waste, has a relatively high radioactivity concentration in a very small volume, such as a radium source used in medical procedures. Estimates of the volumes of discrete NORM waste are imprecise, and the Environmental Protection Agency is conducting studies to provide a more accurate assessment of how much of this waste requires attention. Because of its relatively high concentration of radioactivity, this type of waste poses a direct radiation exposure hazard. The second type, diffuse NORM waste, has a much lower concentration of radioactivity, but a high volume of waste. This type of waste poses a different type of disposal problem because of its high volume.

The sources of most of the radioactivity are isotopes of uranium (<sup>238</sup>U), thorium (<sup>232</sup>Th) and their decay progeny, especially radon (<sup>222</sup>Rn). Because radon is so short-lived, and alpha decays to a number of daughter products which are solid and very short-lived, there is a high probability of its decay when breathed in, or when radon daughter products in dust are breathed in. Alpha particles in the lung are hazardous. Inhalation of radon (<sup>222</sup>Rn) represents the main contribution to the effective dose received by workers [3, 4].

At the Instituto de Pesquisas Energéticas e Nucleares (IPEN), São Paulo, Brazil, there is a facility dealing with high uranium and thorium concentrations, the nuclear materials storage site. In order to estimate afterwards the effective committed dose for workers due to radon inhalation, the radon concentrations at the site are being assessed.

Radon measurements have been carried out through the passive method with SSNTD (Makrofol E), due to their simplicity and long-term integrated read-out. The detector exposure period is three months, covering December 2004 to September 2006.

## 2. Materials and methods

The <sup>222</sup>Rn concentration was obtained by the passive detection method with solid state track detectors in diffusion chambers. Circular pieces (2 cm diameter) of Makrofol-E were used detectors. As a diffusion chamber, a hemispherical housing of 1.5 cm radius with a filter membrane was selected. This glass filter membrane allowed approximately 98% of the radon to diffuse and suppressed thoron gas to 0.5%.

After exposure for approximately 3 months, the detectors were collected and replaced by fresh ones. The detectors were etched in PEW<sub>40</sub> solution at 70°C for 2 h in a constant temperature bath. After etching, the detectors were washed, dried and scanned under a Carl Zeiss microscope for track density measurements. The background is 1500 tracks per cm<sup>2</sup>. Using a calibration factor of  $0.0234 \pm 0.0045$  tracks·cm<sup>-2</sup> per Bq·m<sup>-3</sup>·d, obtained with Pylon model RN-150 calibrated radon gas source, the track density is converted to radon concentration in the environment.

The radon concentration was calculated through the following equation [5]:

$$C = \frac{D}{k \cdot t} \quad (1)$$

where:

- C is the radon concentration (Bq/m<sup>3</sup>)  
D is the track density (tracks/cm<sup>2</sup>)  
K is the calibration factor (tracks/cm<sup>2</sup> per Bq·m<sup>-3</sup>·d)  
t is the exposure time (d).

### 3. Results and conclusions

The contribution from <sup>222</sup>Rn inside the nuclear materials storage site was determined through the passive method with solid state nuclear track detectors (Makrofol E) using Eq. (1). Fifteen points were monitored at the site with two detectors in each point. Table 1 shows the results of average radon concentration and standard deviation at the site obtained from December 2004 to September 2006.

TABLE I. AVERAGE <sup>222</sup>Rn CONCENTRATION AT THE SITE

	Average <sup>222</sup> Rn concentration in air (Bq/m <sup>3</sup> )
December 2004 to March 2005	1227 ± 505
March 2005 to June 2005	648 ± 42
June 2005 to September 2005	993 ± 274
September 2005 to December 2005	947 ± 77
December 2005 to March 2006	1020 ± 401
March 2006 to June 2006	1019 ± 394
June 2006 to September 2006	1025 ± 271

According to Table 1, elevated levels of radon at the site were observed, especially during the first monitoring period (December 2004 to March 2005). During the period March 2005 to June 2005 a lower value of average radon concentration was obtained due to high ventilation rates. The results obtained show that the radon concentration at the site should be continuously monitored.

### REFERENCES

- [1] HIPKIN, J., PAYNTER, R., SHAW, P., Exposure at work to ionising radiation due to the use of naturally occurring radioactive materials in industrial processes, *Appl. Radiat. Isot.* **49** (1998) 149–168.
- [2] KATHREN, R., NORM sources and their origins, *Appl. Radiat. Isot.* **49** (1998) 149–168.
- [3] CAMPOS, M.P., PECEQUILO, B.R.S., “Thoron concentrations at workplaces involving naturally occurring radioactive materials”, *High Levels of Natural Radiation and Radon Areas: Radiation Dose and Health Effects (Proc. 5<sup>th</sup> Int. Conf. Munich)*, (2000) 100–101.
- [4] MAN-YINW. TSO, CHUNG-CHUEN LI, Indoor and outdoor <sup>222</sup>Rn and <sup>220</sup>Rn daughters in Hong Kong, *Health Phys.* **53** 2 (1987) 175–180.
- [5] MAYYA, Y.S., EAPPEN, K.P., NAMBI, K.S.V., Methodology for mixed field inhalation dosimetry in monazite areas using a twin-cup dosimeter with three track detectors, *Radiat. Prot. Dosim.* **77** 3 (1998) 177–184.





# Fluxes and enhancement of natural radionuclides in a pulp mill factory located in the south-west of Spain

F. Vaca<sup>a</sup>, G. Manjón<sup>b</sup>, M. García-León<sup>c</sup>, G. Mora<sup>a</sup>, R. García-Tenorio<sup>b</sup>

<sup>a</sup>Departamento de Física Aplicada, Facultad de Ciencias Experimentales  
Universidad de Huelva  
Huelva, Spain

<sup>b</sup>Departamento de Física Aplicada 2, ETS Arquitectura  
Universidad de Sevilla  
Sevilla, Spain

<sup>c</sup> Departamento de Física Atómica, Molecular y Nuclear, Facultad de Física  
Universidad de Sevilla  
Sevilla, Spain

**Abstract.** Activity concentrations of several naturally occurring radionuclides (with <sup>226</sup>Ra as a key radionuclide) have been determined by different radiometric techniques in samples representative of the raw material (eucalyptus wood, fresh water), industrial process (liquors) and wastes (sludges, ashes) of a pulp-mill factory located in the south-west of Spain. This facility follows the so-called alkaline process for the production of cellulose pulp, and especially in several steps of its recycling line (in the so-called Ca-cycle) tends to concentrate several natural radionuclides. Annually in this factory, 725 000 m<sup>3</sup> of wood are treated and 241 404 t of cellulose are produced. Radiometric determinations have allowed us to evaluate the fluxes of several natural radionuclides throughout the process and to determine their enrichment factors. In this sense, we can indicate that, annually, more than 200 MBq of <sup>226</sup>Ra enters the process associated with the raw material, about 160 MBq leaves the production process associated with wastes, while annual fluxes ranging from 1200–1800 MBq have been found in the Ca-cycle of the recycling line.

## 1. Introduction

A factory in the vicinity of Huelva in south-west Spain is the most important pulp mill in the country. This factory has been operating since the 1960s using two different types of eucalyptus trees as raw material: *Eucalyptus Globulus* (90 %) and *Eucalyptus Rostrata* (10 %). Wood and bark from the trees are separated, using wood for pulp production and barks as fuel for electricity production in a power plant. The factory has reported a typical annual production of about 250 000 t of cellulose pulp from a feed of about 750 000 m<sup>3</sup> of wood and 20 million m<sup>3</sup> of water as raw material [1].

The cellulose pulp process is a basic treatment, using NaOH, Na<sub>2</sub>S and Na<sub>2</sub>CO<sub>3</sub> as digesting agents (white liquor). A simplified scheme of the factory is presented in Fig. 1. Eucalyptus trees are cultivated in a nearby plantation [2, 3]. Tree trunks are collected and transported to the factory and then stored in a wood park. Next, the wood and bark are separated. Barks are conveyed into a power plant generating electricity and steam, both of which are consumed by the factory, whereas the wood is ground to chip size. The chips are discharged into a digester recipient, where they are thoroughly mixed with white liquor. Cellulose pulp and the rest of the mixture (the black liquor) are separated in a washing plant. Cellulose pulp is finally bleached and dried. Black liquors are recycled in order to recover the digesting agents.

Black liquors from the washing plant have a 16 % dry weight concentration (diluted black liquor) and are first evaporated. The dry weight concentration increases to 63% during this process. The concentrated black liquor is boiled to obtain Na<sub>2</sub>S and Na<sub>2</sub>CO<sub>3</sub> as a solid ‘smelted’. This is dissolved with weak liquor, which is conveyed from another area of the factory, obtaining in this way the green liquor. The insoluble phase (sludge) is separated by decantation in the green liquor clarifier (Fig. 1) and the supernatant is conveyed into the slaker-clarifier. In this process the third digesting agent, NaOH, is recovered in the following reaction:

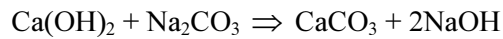

The products of this reaction are NaOH (supernatant) and CaCO<sub>3</sub> (solid residue). The liquid phase (white liquor) is separated by filtration and the filtrate (lime sludge) is recycled in order to recover the Ca(OH)<sub>2</sub>. Once washed and thickened, the lime sludge is burnt in the lime kiln (Fig. 1) where CaO is obtained according to the following reaction:

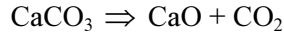

Finally the Ca(OH)<sub>2</sub> is obtained in the lime quencher according to the following reaction:

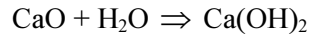

The production line processes and the recovery cycles (Na cycle and Ca cycle) cause waste discharges to the nearby environment. These wastes are solid (bark ash, sludge), liquid (supernatant of sludge, which was rejected from the recovery cycles) and gas (directly released to the atmosphere). The annual waste discharges are shown in Table 1.

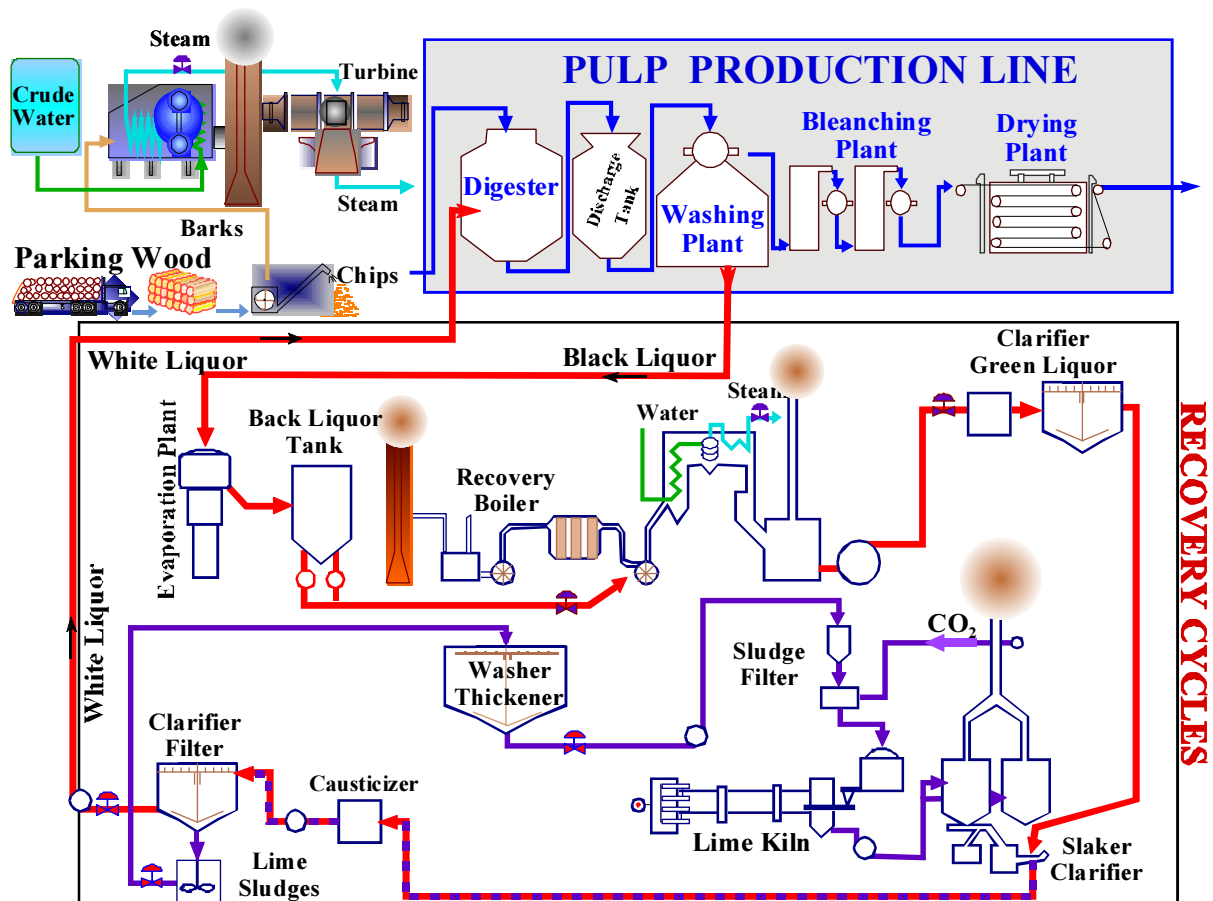

FIG. 1. Simplified scheme of the pulp mill, showing the pulp production line and recovery area. A second recovery process (the so-called Na-cycle) is added to the main recovery cycle (the so-called Ca-cycle)

TABLE 1. WASTE DISCHARGED FROM THE MILL [1]

	Process	Annual quantity per tonne of cellulose pulp (kg)
Liquid wastes	Decantation of sludges	1,000
Sludge	Decantation of sludges	20
Green liquor sludge	Clarifier of green liquor	6.7
Lime sludge	Lime slacker	0.27
Ash (bark, sludge)	Power plant	9

## 2. Experimental

The samples collected for this work are presented schematically in Fig. 2. The number of samples collected in the factory was 44. These samples were distributed throughout the production line (18 samples), recovery cycles (17 samples), raw material stores (4 samples) and waste discharge devices (5 samples). Gas waste discharges were not sampled.

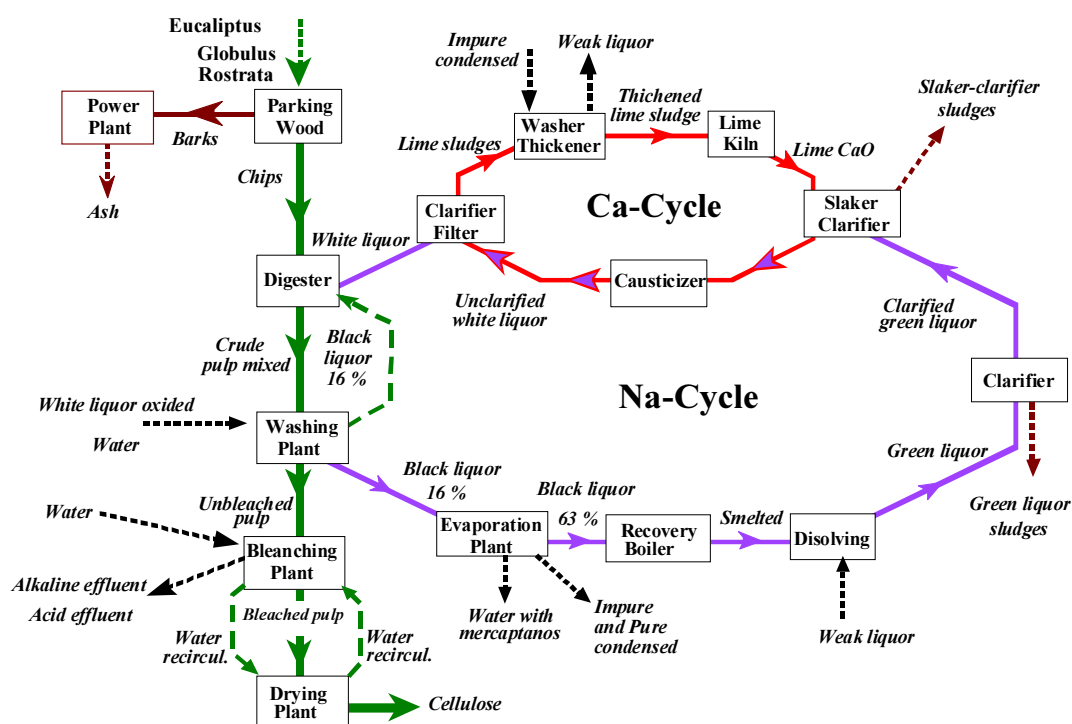

Figure 2: A simplified scheme of the processes where the samples studied in this work are shown. The pulp production line processes and the recovery cycles, Na-cycle and Ca-cycle, are clearly remarked.

Solid samples were dried at 80°C and powdered immediately after their collection. Evaporation of liquid samples was systematically done in order to minimize the volume and decrease the detection limits. The activity concentration of some natural radionuclides was determined by  $\gamma$ -spectrometry.  $^{228}\text{Ra}$  and  $^{228}\text{Th}$  were determined through the emissions of  $^{228}\text{Ac}$  ( $E_\gamma = 911.1$  keV) and  $^{208}\text{Tl}$  ( $E_\gamma = 583.2$  keV), respectively. The  $^{226}\text{Ra}$  activity concentration was measured by the emissions of  $^{214}\text{Pb}$  ( $E_\gamma = 352.0$  keV). For this, a conventional HPGe coaxial counter was used (1.88 keV of resolution and 14% of relative efficiency for the 1330 keV photopeak of  $^{60}\text{Co}$ ). The counting geometry was cylindrical and the spectrometer was calibrated against the photopeak efficiency by applying the generalized transmission method of Bolívar et al [4].

### 3. Results

The enrichment factor has been defined [5] as the quotient obtained when the activity concentration of a radionuclide in a sample collected in the factory (e.g. production line, recycling processes) divided by the activity concentration of the same radionuclide in wood chips (the main raw material). The possible concentration of radionuclides in some of the processes can be easily determined by the enrichment factor. The activity concentration of artificial radionuclides ( $^{90}\text{Sr}$ ,  $^{137}\text{Cs}$ ) in the factory obtained in this work can be found in Ref. [6], whereas the activity concentration of natural radionuclides ( $^{226}\text{Ra}$ ,  $^{228}\text{Ra}$ ,  $^{228}\text{Th}$ ) in the same samples was reported in Ref. [7].

The enrichment factors in the different samples are listed in Table 2. A first comment can be made regarding the enrichment of natural radionuclides observed in bark samples, where the enrichment factor was 6–8, depending on the radionuclide ( $^{226}\text{Ra}$ ,  $^{228}\text{Ra}$  or  $^{228}\text{Th}$ ). These three radionuclides were not detected in the pulp production line or in the Na cycle. However, relatively high enrichment factors were found in the Ca cycle, where the enrichment factor was 30–58 in lime CaO, depending on the radionuclide. Lower enrichment factors were observed in the rest of the samples belonging to the Ca cycle processes, where values of 2–26 were obtained, depending on the radionuclide and kind of sample.

TABLE 2. ENRICHMENT FACTORS [5] (Sampling stations shown in Fig. 2)

	Enrichment factor			
	$^{226}\text{Ra}$	$^{228}\text{Ra}$	$^{228}\text{Th}$	$^{40}\text{K}$
<i>Raw material and digesting agents</i>				
Bark	$7 \pm 1$	$6 \pm 1$	$8 \pm 1$	$3.4 \pm 0.3$
Chips	1	1	1	1
Black liquor 16%	$< 1.5$	$< 1.4$	$< 1.6$	$4.6 \pm 0.4$
White liquor	$< 2.4$	$< 2.3$	$< 2.7$	$13 \pm 1$
<i>Pulp production line</i>				
Crude pulp mixed	$< 1.3$	$< 1.0$	$< 1.3$	$5.6 \pm 0.5$
White liquor oxidized	$< 2.4$	$< 2.2$	$< 2.5$	$14 \pm 1$
Unbleached pulp	$< 1.7$	$< 1.3$	$< 1.6$	$0.28 \pm 0.08$
<i>Na cycle</i>				
Black liquor 60%	$< 4.7$	$< 4.0$	$< 4.8$	$18 \pm 1$
Smelted	$< 8.9$	$< 7.7$	$< 9.6$	$48 \pm 4$
Weak liquor	$< 0.3$	$< 0.3$	$< 0.4$	$2.0 \pm 0.2$
Green liquor	$< 1.6$	$< 1.6$	$< 2.0$	$14 \pm 1$
Clarified green liquor	$< 1.5$	$< 1.3$	$< 1.4$	$6.0 \pm 0.4$
<i>Ca cycle</i>				
Lime CaO	$58 \pm 8$	$30 \pm 4$	$28 \pm 4$	$< 1.7$
Unclarified white liquor	$2.7 \pm 0.7$	$1.9 \pm 0.2$	$1.0 \pm 0.6$	$14 \pm 1$
Lime sludges	$16 \pm 2$	$9 \pm 1$	$8 \pm 2$	$7.2 \pm 0.6$
Thickened lime sludge $\text{CaCO}_3$	$26 \pm 4$	$20 \pm 4$	$12 \pm 4$	$< 2.4$
<i>Wastes</i>				
Green liquor sludges	$43 \pm 6$	$24 \pm 4$	$65 \pm 9$	$7.2 \pm 0.8$
Slaker-clarifier sludges	$15 \pm 3$	$14 \pm 3$	$15 \pm 3$	$1.8 \pm 0.4$
Decanted mud	$27 \pm 4$	$18 \pm 2$	$22 \pm 3$	$< 0.8$
Ash	$113 \pm 15$	$103 \pm 14$	$116 \pm 17$	$47 \pm 4$

The other natural radionuclide,  $^{40}\text{K}$ , which is not associated with the cellulose pulp, was observed in the samples collected in the Na cycle area of the factory (Table 2). The enrichment factor for  $^{40}\text{K}$  was 2–48 in the Na cycle processes, depending on the radionuclide and kind of sample.

Finally, the most relevant enrichment factors were observed in the solid and liquid wastes (Table 2). This was the case of the ash (bark and other sludges are usually burnt for power and steam production), where the enrichment factors were 100–116 for the three radionuclides  $^{226}\text{Ra}$ ,  $^{228}\text{Ra}$ ,  $^{228}\text{Th}$ .

The fluxes of radionuclides are listed in Table 3. According to these data, the natural radionuclide input was associated with raw material (chips and bark of eucalyptus). The highest annual fluxes corresponded to  $^{40}\text{K}$  (250 000 MBq). Losses of  $^{40}\text{K}$  along the Na cycle, mainly in the green liquor clarifier, can be inferred. The annual input fluxes of  $^{40}\text{K}$ , associated with smelted + weak liquor, reached 150 000 MBq and the output fluxes, associated with the clarified green liquor, were 130 000 MBq, which are in sufficient agreement, and thereby, the validity of the experiment can be confirmed. The annual fluxes of the other natural radionuclides ( $^{226}\text{Ra}$ ,  $^{228}\text{Ra}$ ,  $^{228}\text{Th}$ ) were 1.0–1.8 GBq and were detected in the samples collected from the Ca cycle. Some losses of such radionuclides, associated with waste discharges (green liquor sludges and lime sludges), can be inferred.

TABLE 3. RADIONUCLIDE FLUXES (Sampling stations shown in Fig. 2)

	Annual radionuclide flux (MBq)			
	$^{226}\text{Ra}$	$^{228}\text{Ra}$	$^{228}\text{Th}$	$^{40}\text{K}$
<i>Raw material and digesting agents</i>				
Barks	163 ± 14	185 ± 20	145 ± 15	3500 ± 200
Chips globulus	196 ± 23	249 ± 28	163 ± 19	9100 ± 500
Black liquor 16%	< 530	< 620	< 480	75 000 ± 4000
White liquor	< 900	< 1150	< 840	209 000 ± 11 000
<i>Pulp production line</i>				
Crude pulp mixed	< 1420	< 1430	< 1130	285 000 ± 14 000
White liquor oxidized	< 45	< 63	< 40	11 900 ± 600
<i>Na cycle</i>				
Black liquor 60%	< 1300	< 1430	< 1090	228 000 ± 12 000
Smelted	< 460	< 520	< 420	117 000 ± 6000
Weak liquor	< 138	< 170	< 140	37 000 ± 2000
Green liquor	< 750	< 940	< 750	288 000 ± 14 000
Clarified green liquor	< 680	< 760	< 550	129 000 ± 2000
<i>Ca cycle</i>				
Lime CaO	1810 ± 120	1204 ± 105	740 ± 70	< 2500
Unclarified white liquor	1300 ± 280	< 1200	400 ± 240	310 000 ± 16 000
Lime sludges	1853 ± 190	1730 ± 180	840 ± 140	40 200 ± 2500
Thichened lime sludge $\text{CaCO}_3$	1250 ± 150	1040 ± 150	615 ± 260	< 5000
<i>Wastes</i>				
Green liquor sludges	32 ± 3	11 ± 1	40 ± 3	220 ± 20
Slaker-clarifier sludges	0.44 ± 0.06	0.52 ± 0.09	0.37 ± 0.06	2.5 ± 0.5
Decanted mud	60 ± 4	48 ± 4	40 ± 3	< 80
Ash	110 ± 10	120 ± 10	80 ± 6	1500 ± 80

A balance of input and output fluxes of radionuclides in the power plant is shown in Fig. 3. The bark of eucalyptus trees and the sludges from a general decanter of the factory are burnt in the power plant boiler. According to this balance, a similar amount of natural radionuclides is discharged into the environment as either aerosol or solid wastes.

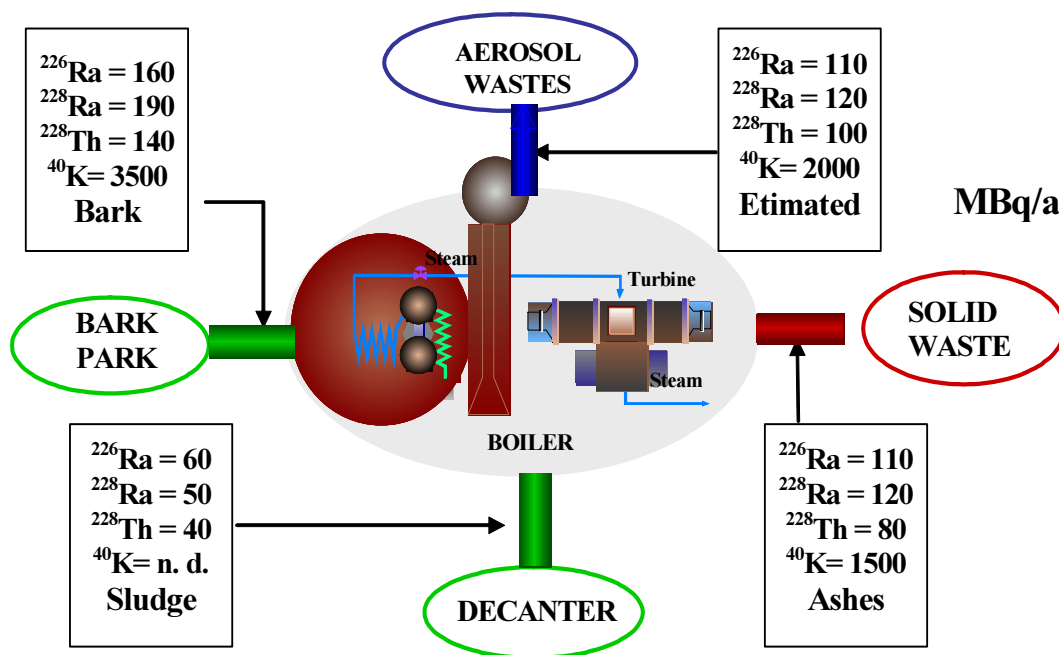

FIG. 3. Fluxes of  $^{226}\text{Ra}$ ,  $^{228}\text{Ra}$ ,  $^{228}\text{Th}$  and  $^{40}\text{K}$  in the power plant boiler. The fluxes associated with gas waste discharges have been estimated

A global balance of radionuclide fluxes, considering the fluxes associated with waste discharges, is shown in Table 4. Although most of the input fluxes of radionuclides are released to the environment, we have observed that the continuous operation of the factory causes an increase in radionuclide activity concentrations in the recovery cycles.

#### 4. Conclusions

An exhaustive programme of sampling, analysis and determination of activity concentration, enrichment factor and annual flux of natural radionuclides has been developed. The enrichment factors showed that the main accumulation of  $^{40}\text{K}$  is in the Na cycle whereas  $^{226}\text{Ra}$ ,  $^{228}\text{Ra}$  and  $^{228}\text{Th}$  were concentrated mainly in the Ca cycle. These results can be explained by two facts: first, the similar behaviour of potassium and sodium, and second, the similar behaviour of radium, thorium and calcium.

The mean annual flux in the Na cycle reached 250 000 MBq for  $^{40}\text{K}$ . In the Ca cycle, the mean annual flux of  $^{226}\text{Ra}$ ,  $^{228}\text{Ra}$  and  $^{228}\text{Th}$  was 800–1800 MBq.

In the power plant it is estimated that 55% ( $^{40}\text{K}$ ) and about 50 % ( $^{226}\text{Ra}$ ,  $^{228}\text{Ra}$ ,  $^{228}\text{Th}$ ) of the input fluxes are discharged as aerosols and the rest are associated with solid wastes. The global balance of the fluxes of natural radionuclides associated with raw material and wastes has been calculated or estimated and a positive increase with time of natural radionuclides in the factory can be inferred.

#### ACKNOWLEDGEMENT

The collaboration of the management and staff of “Empresa Nacional de Celulosas S.A. en Huelva (Spain)” is deeply acknowledged.

TABLE 4. GLOBAL BALANCE OF RADIONUCLIDE FLUXES ASSOCIATED WITH RAW MATERIAL AND WASTE DISCHARGES

\* = estimated n d = not detected

	Annual radionuclide flux (MBq)				Emission (%)
	Raw material		Wastes		
<sup>40</sup> K	Wood	10600 ± 500	Solid	1550 ± 83	30
	Bark	3500 ± 200	Liquid	600*	
			Aerosol	1900*	
<sup>226</sup> Ra	Wood	196 ± 23	Solid	142 ± 6	70
	Bark	164 ± 14	Liquid	n d	
			Aerosol	120*	
<sup>228</sup> Ra	Wood	249 ± 28	Solid	129 ± 7	55
	Bark	185 ± 20	Liquid	n d	
			Aerosol	110*	
<sup>228</sup> Th	Wood	163 ± 19	Solid	135 ± 6	75
	Bark	145 ± 15	Liquid	n d	
			Aerosol	100*	

#### REFERENCES

- [1] EMPRESA NACIONAL DE CELULOSA, Balance Técnico de la Fábrica de Huelva. 1993, ENCE, Huelva, Spain (1994).
- [2] VACA, F., MANJÓN, G., GARCÍA-LEÓN, M., The presence of long-lived artificial radionuclides in a eucalyptus forest at the south of Spain, J. Environ. Radioact. **56** (2001) 309–325.
- [3] VACA, F., MANJÓN, G., GARCÍA-LEÓN, M., Radionuclides of the <sup>238</sup>U- and <sup>232</sup>Th-series in soil samples collected in a Mediterranean eucalyptus forest: transference from soil to eucalyptus trees, IRPS Bulletin **15** 1(2001).
- [4] BOLÍVAR, J.P., GARCÍA-TENORIO, R., GARCÍA-LEÓN, M., A method for the determination of counting efficiencies in  $\gamma$ -spectrometric measurements with HPGe detectors, Nucl. Instr. Meth. A **382** (1996) 495–502.
- [5] RAVILA, A., HOLM, E., Radioactive elements in the forest industry, Sci. Total Environ. **157** (1994) 339–356.
- [6] VACA, F., MANJÓN, G., GARCÍA-LEÓN, M., <sup>90</sup>Sr in an alkaline pulp mill located in the south of Spain, J. Environ. Radioact. **46** 3 (1999) 327–344.
- [7] VACA, F., MANJÓN, G., GARCÍA-LEÓN, M., Radioactive discharges from an alkaline pulp mill located in the south of Spain, J. Environ. Radioact. **52** 1 (2001) 91–97.

