

DECLARATION

This research project is part of my 5th year thesis and is my original work. It has not been presented for a degree in any other university.

H. Sehmi

HARJEET SINGH SEHMI

December 1977

This research project is submitted as part of the university examination for the degree of Bachelor of Architecture.

PROF. HENRY WOOD

CHAIRMAN OF THE DEPARTMENT OF ARCHITECTURE

DEAN OF FACULTY

UNIVERSITY OF NAIROBI

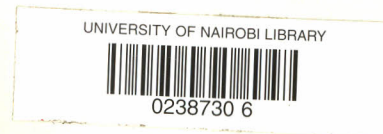

ACKNOWLEDGEMENT

With true appreciation for his assistance I wish to thank Dr. Galluisi, the project manager of Nairobi International Airport for granting me permission of free movement and research within the airport.

My special thanks go to Mr. Anderson of Alexander Gibbs and Partners, who helped me a great deal with my research questionnaires etc.

I am grateful to Mr. Roger and Mr. White, also of Alexander Gibbs and Partners, for providing me with technical information on the airport.

Last but not least I would like to thank my tutors, Dr. Meffert and Mr. Archer, for their guidance in this project.

INDEX

	<u>Pages</u>
Index	1- 2
Preface	3
Introduction	4
Areas of Research	5
Method	6- 7
Measurement of noise	8
Site plan	9
Plans of Nairobi International Airport	10-11
Plan of Domestic Community Terminal	12
Plan of Central Terminal Building - level 4	13
Symbols	14
Precast concrete wall	15

	<u>Pages</u>
Detail A	16
Results and evaluation	17
Curtain wall	18
Detail B	19
Results and evaluation	20
Cavity wall	21
Results and evaluation	22
Partition with chipboard infill	23
Detail D	24
Results and evaluation	25
Comments and improvements	26
Improved detail of intersection post and skirting	27
Hollow concrete blockwall	28
Detail E	29
Results and evaluation	30
Comments and improvements	31
Improved detail of corner detail E	32
Conclusion	33
Bibliography	34

PREFACE

For my first term research project I investigated sound insulation values of some of the building elements and their application to noise control.

Architects use laboratory determined insulation values during the design stage. However, wide variations exist in the size of tested enclosures and in the diffusive and absorptive characteristics of adjoining rooms, often resulting in a considerable disagreement, particularly when taking into account the quality of materials and workmanship, both of which greatly affect the insulation property of building elements.

When the building is nearing completion essential building elements should be tested for their insulation values and modifications should be made at this stage rather than having to make changes when the building is in use (which is often the case), thereby incurring great expense and sometimes necessitating the closing down of the building for improvements.

INTRODUCTION

I have chosen the terminal building of Nairobi International Airport (NIA) for my investigations on sound insulation and noise control. I chose an airport because I would like to incorporate the results of my research into my fifth year thesis project "Malindi Airport Development".

NIA provides a perfect example for findings on sound insulation values of certain elements, since the buildings are nearing completion and necessary changes, if any, can be made before the building is in use. The NIA is due to open by early 1978. At this stage electrical systems, furniture and various equipment are being installed.

Since it is not within the scope of my research to look into all the building elements and areas which may need noise control I have restricted myself to investigate insulation values of different types of walls and partitions only, to find out whether they provide adequate sound insulation in their immediate surroundings. Where I found them to be inadequate I have suggested some methods of improvement.

I have chosen two areas for my research, one being the Domestic Community Terminal (see figure 1), the second being the Central Terminal building. These areas were chosen after a careful study of the NIA-plans, so that I could test a maximum number of different kinds of walls and partitions within a certain area.

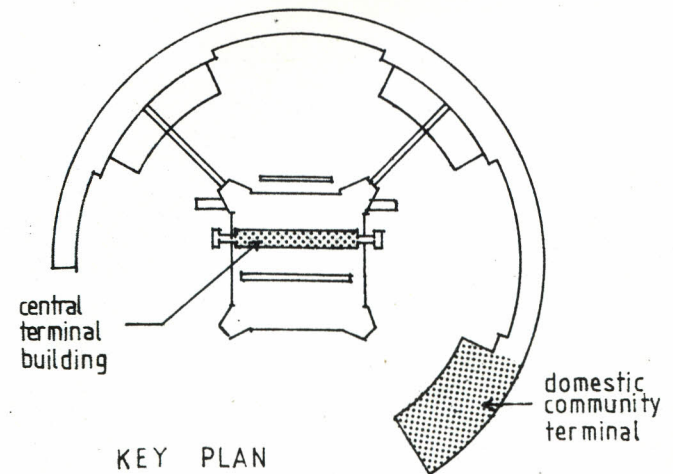

KEY PLAN
FIG. 1

AREAS OF RESEARCH

For Sound Insulation

- A Precast concrete wall
- B Curtain wall
- C Cavity wall
- D Hollow concrete blockwall
- E Partition with chipboard infil.

For Noise Control

- Transfer lounge
- Transit and departure lounge
- Apron Marshaller's office and apron workers rest room
- Transit accomodation - bedrooms
- Offices (airport management)

METHOD

Sound Insulation

Mixed frequency (random) sound is produced at a certain sound pressure by the random sound generator and loudspeaker on one side of the building element.

The sound which passes through the building element to the other side is measured by means of a sound level meter.

The difference in readings, given in decibels (dB), is the sound insulation value (or sound transmission loss) of that particular element.

Noise Control

The sound level meter readings which were taken at Embakasi Airport in various parts of the terminal during peak hours of aircraft and passenger movements have been applied as expected noise level at NIA.

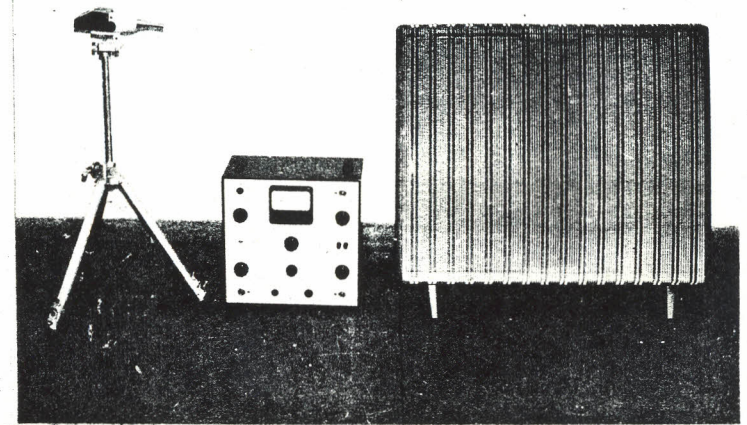

Fig. 2 - from left to right:
sound level meter, random
noise generator and loudspeaker

The sound insulation values of any particular wall or partition were the actual readings obtained from the research carried out at NIA.

The difference between the expected noise level and the sound insulation value of the wall or partition gave the incoming noise level.

The incoming noise level was compared with the recommended noise levels *1.

Where a wall or partition was found to provide inadequate noise control to its immediate surrounding I have suggested methods in which the sound insulation values could be improved to acceptable standards so that they would provide the required noise control.

*1 see Page 34

MEASUREMENT OF NOISE *1,*2

Noise can be measured by means of a sound level meter (see fig. 3) in terms of decibels.

The sound level meter consists of a measuring microphone, amplifier and meter. To measure sound or noise physically and also to relate the measurements to subjective human reactions, the sound level meter provides alternative frequency-response characteristics by including 'Weighting Networks' designated A, B and C. These networks discriminate against low and high frequencies by approximating the frequency-response of the human ear by following the 40, 70 and 100 phon equal-loudness curves, respectively.

A-weighting should be used for measuring noise levels below 55 dB.

B-weighting should be used for noise between 55 and 85 dB.

C-weighting should be used for noise above 85 dB.



Fig. 3

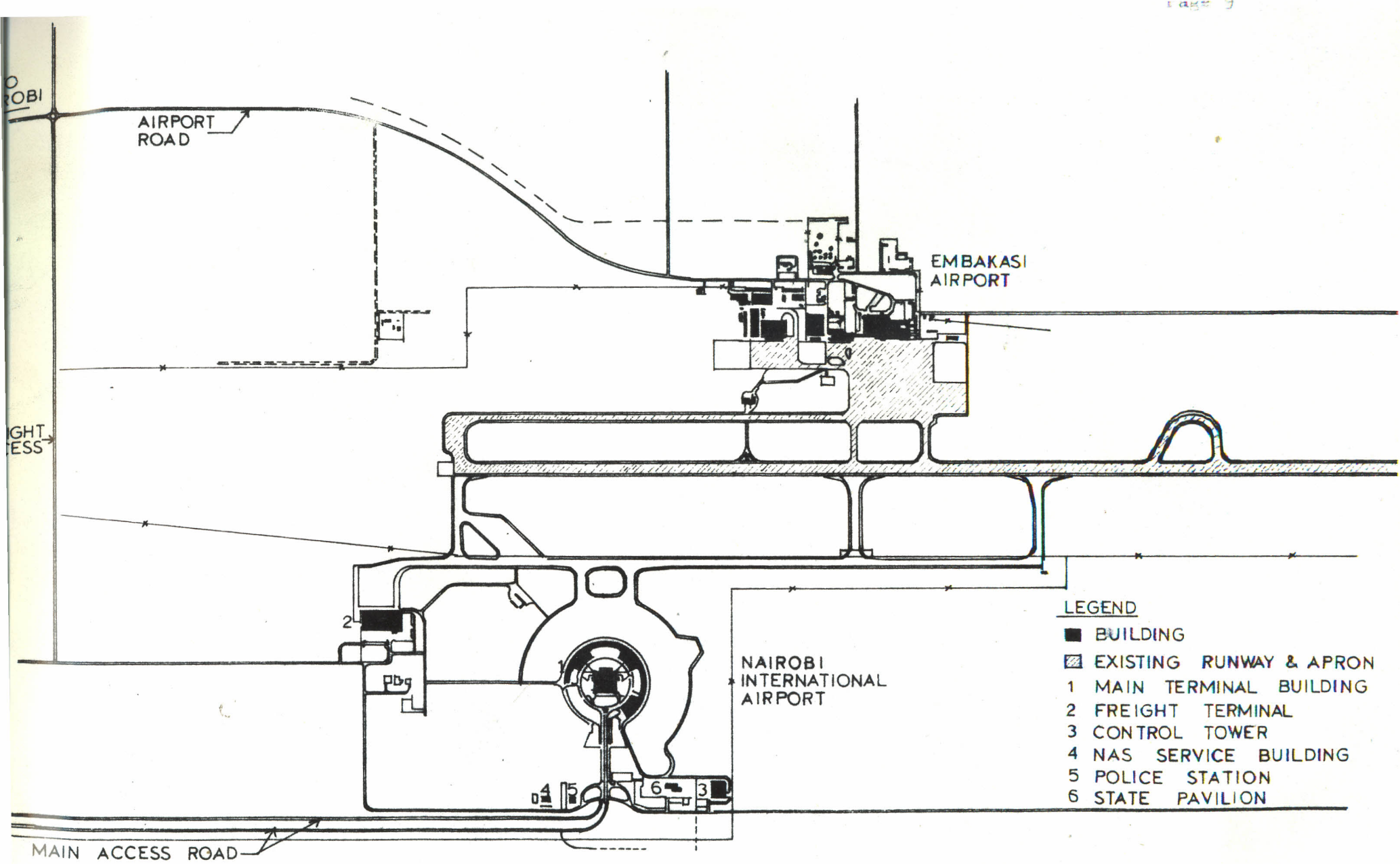

site plan

SCALE 1:20000



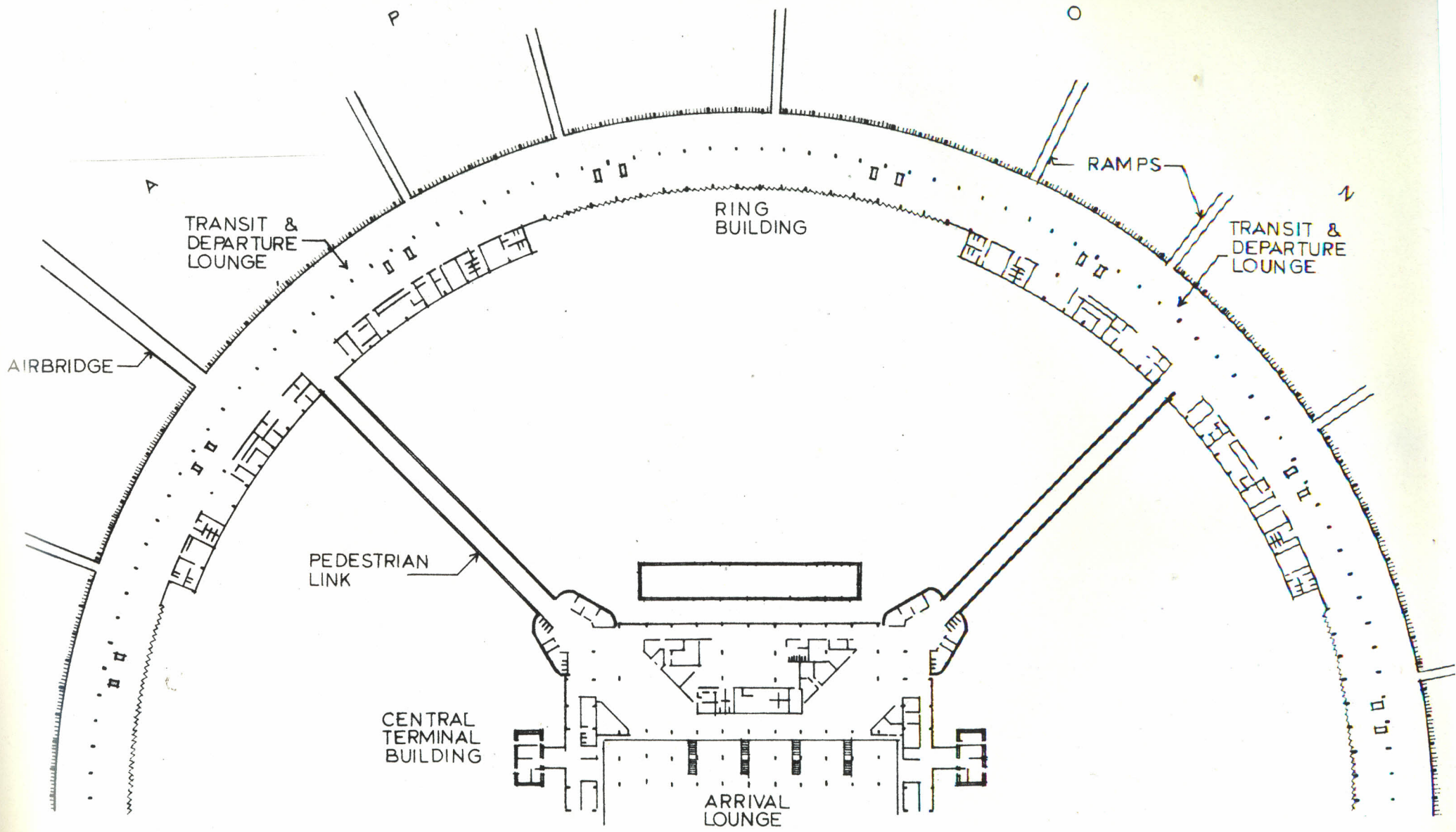

plan of passenger terminal - level 1

SCALE 1 : 1000

CENTRAL
TERMINAL
BUILDING

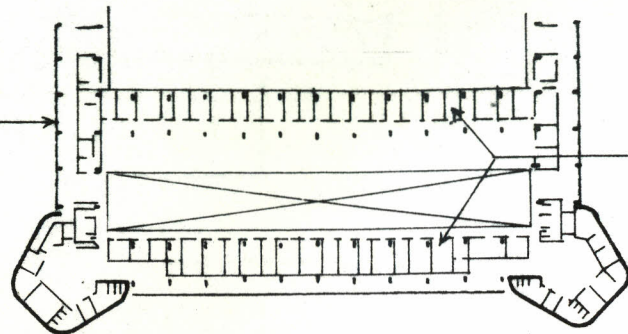

AIRLINE
ADMINISTRATION
OFFICES

DOMESTIC
COMMUNITY
TERMINAL

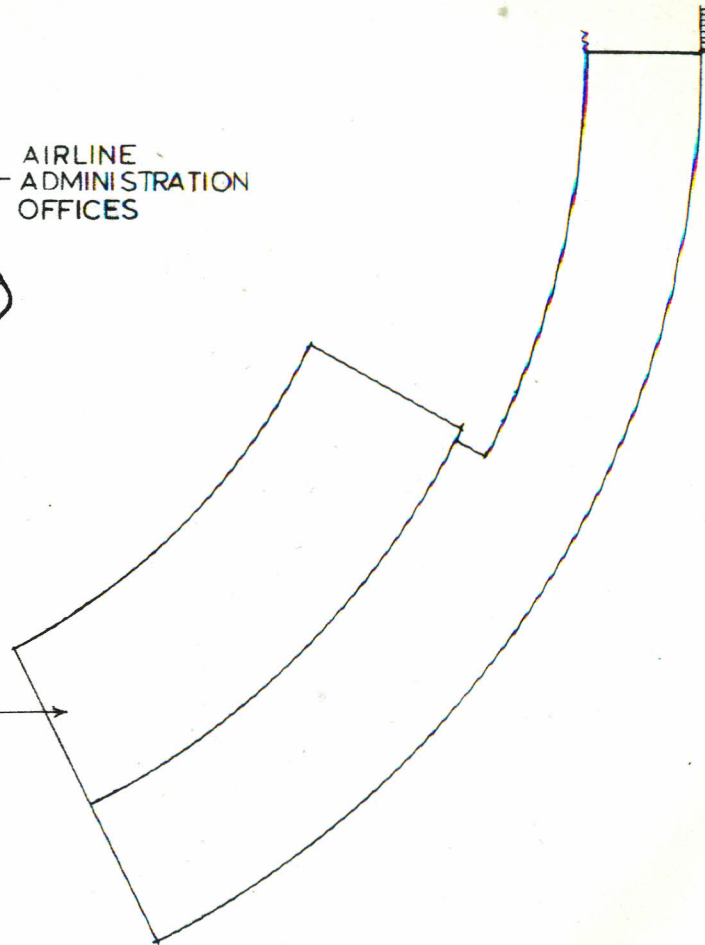

plan of passenger terminal - level 1

SCALE 1 : 1000



A

N

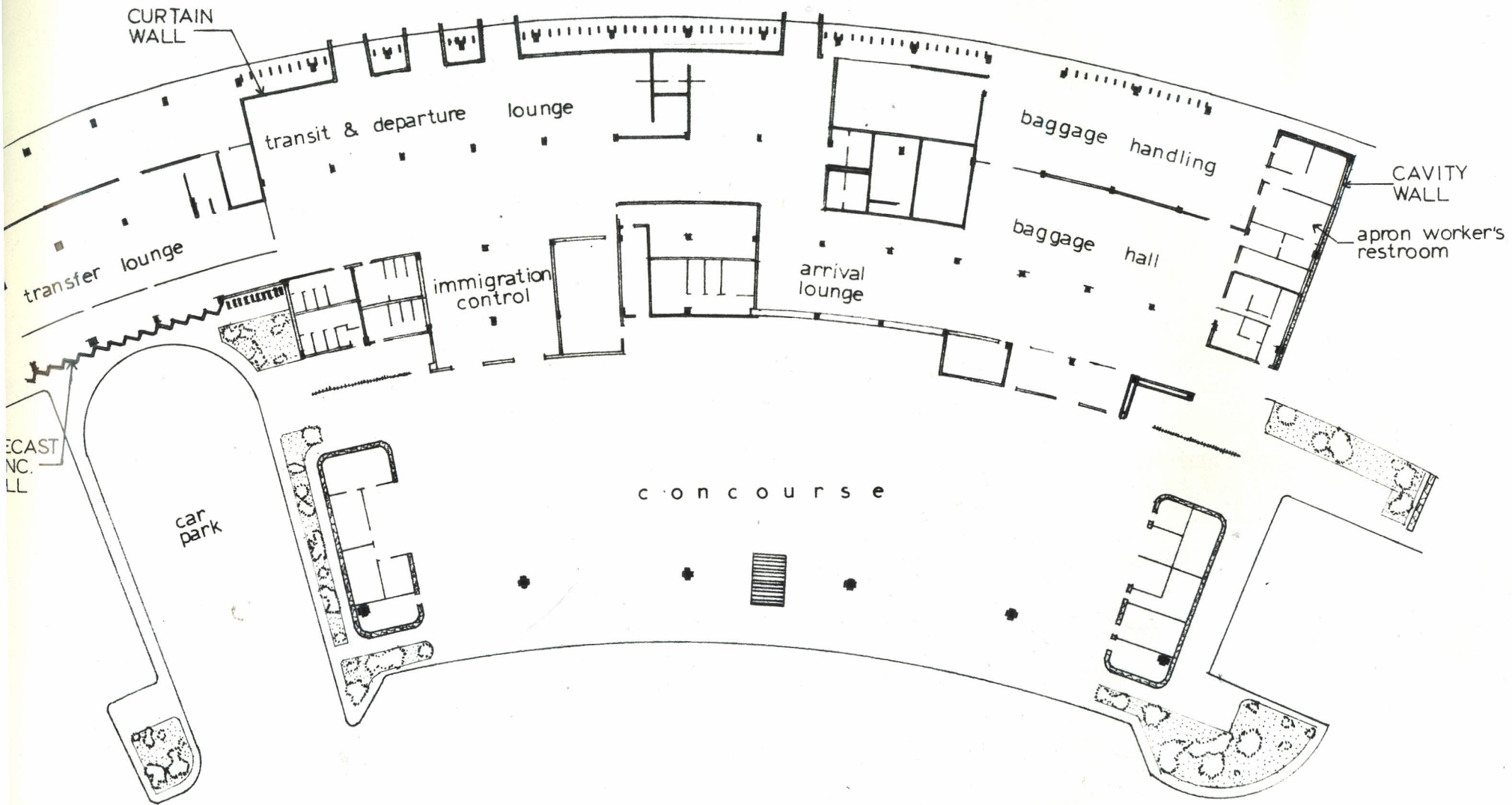

plan of domestic community terminal

SCALE 1:500

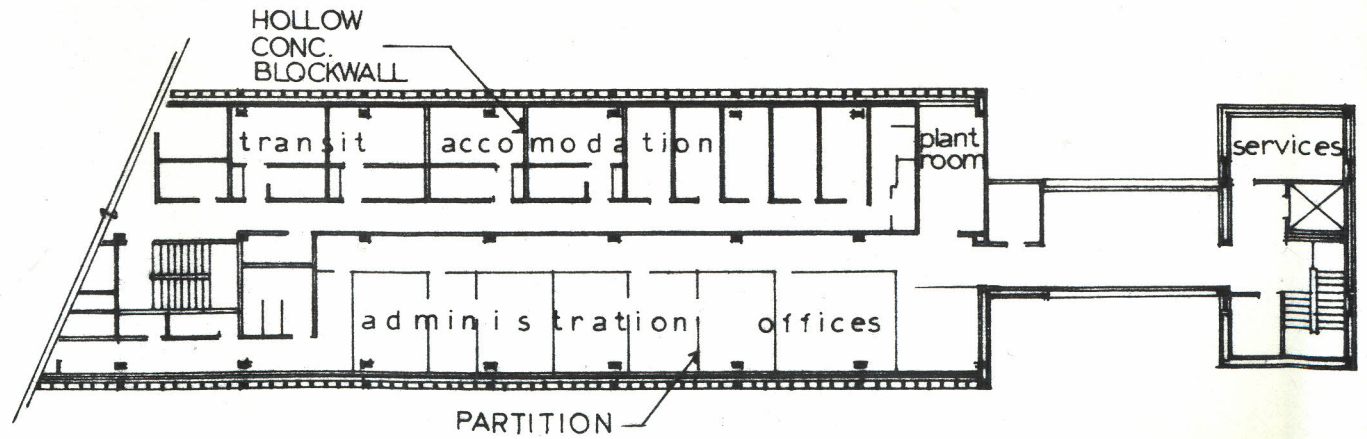
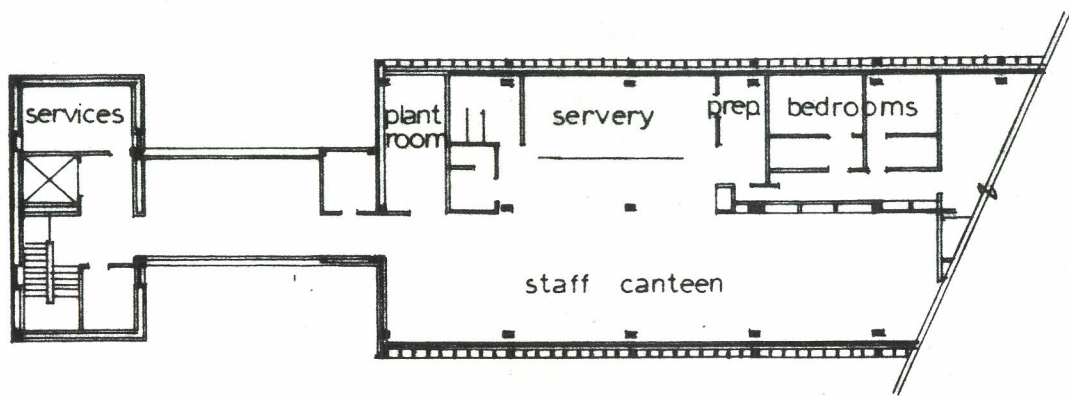

plan of central terminal building
 level 4
 SCALE 1:333

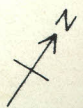

SYMBOLS

Refers to passage of sound from the tests carried out at Nairobi International Airport.



Refers to the position of the source of noise, i.e. random noise generator and loudspeaker.



Shows the position of the sound level meter.

*1

Information taken or referred to from a book. The number indicates the particular book listed in the bibliography, Page 34



This particular reading was taken for reasons given on Page 8

precast conc. wall

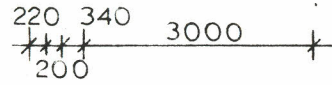

PRECAST
CONC. WALL
TO DETAIL

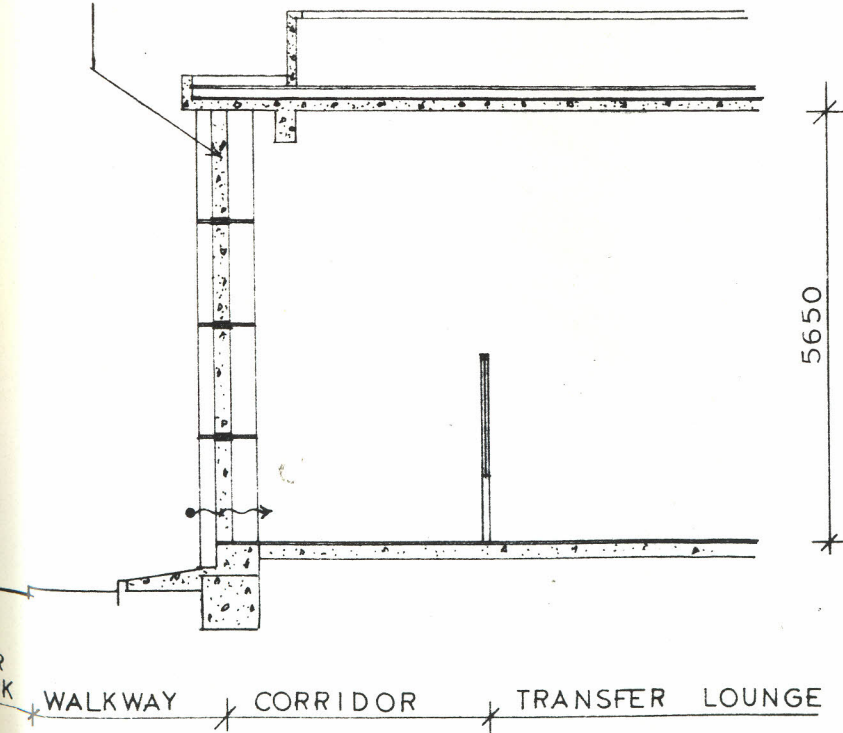

section a-a

SCALE 1:100

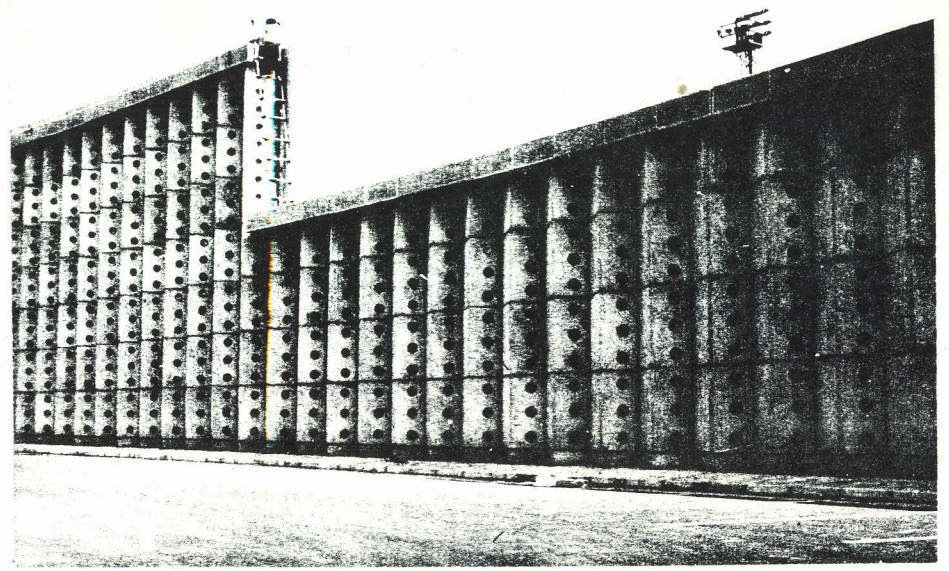

elevation

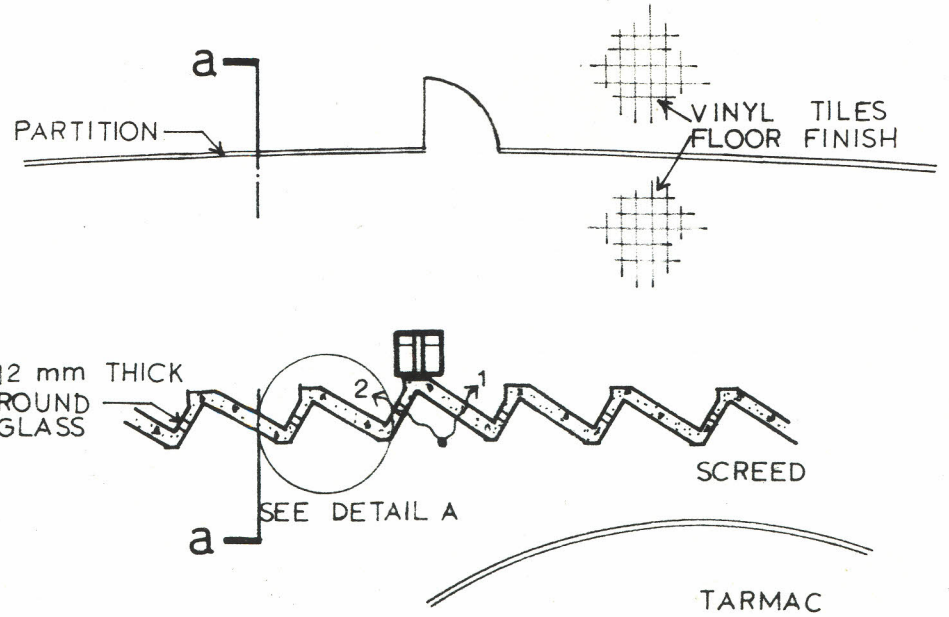

plan

SCALE 1:100

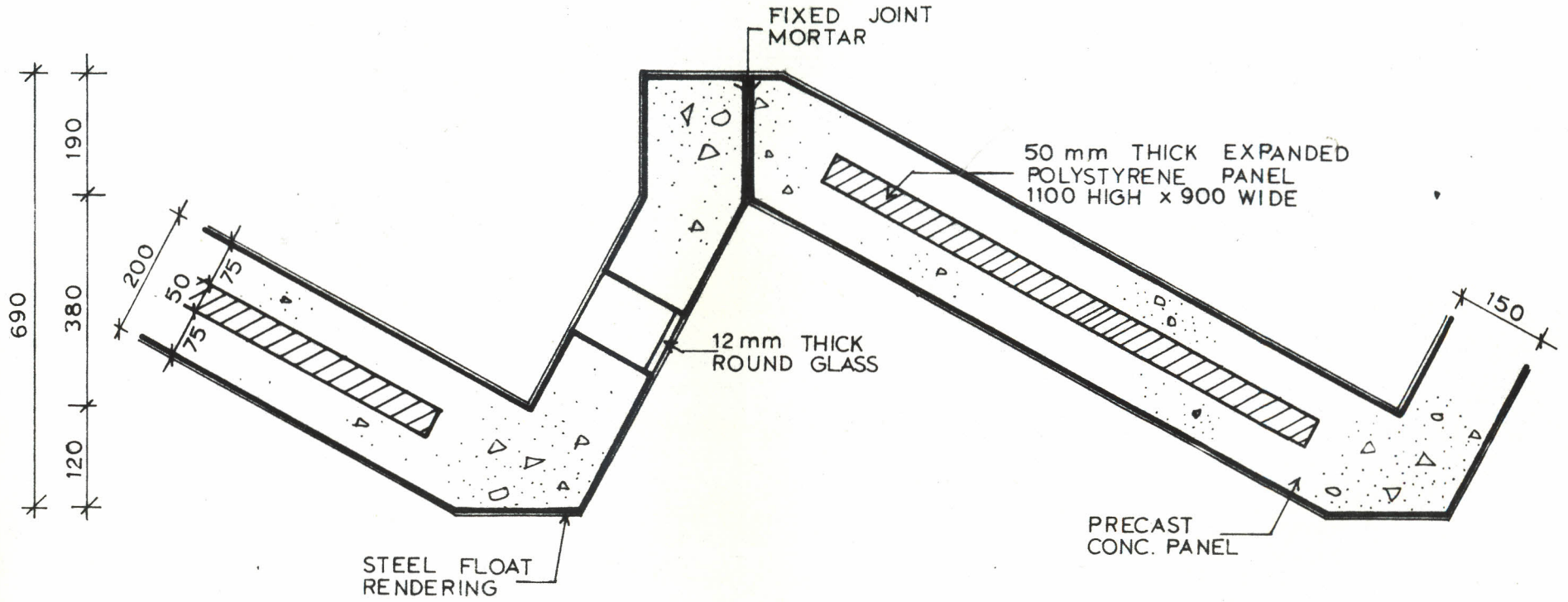
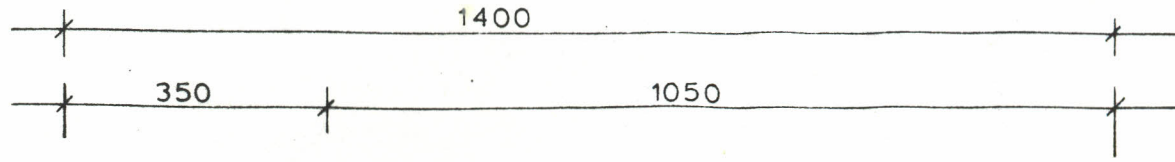

detail A

SCALE 1:10

PARTICULARS	A	B	C	SOUND INSULATION IN dB	EVALUATION
Sound produced by loudspeaker 1 metre away in open	80	84	88		
1. Sound coming into the corridor through precast concrete panel with polystyrene infil	35	40	54		
Sound insulation value of precast concrete panel with polystyrene infil				53	The precast concrete wall has a very high sound insulation value
2. Sound coming into the corridor through precast concrete panel with 12 mm thick round glass	36	42	54		
Sound insulation value of precast concrete panel with 12 mm thick round glass				52	
Maximum sound level expected from traffic noise measured at 3 metres from passing cars (measured at Embakasi Airport next to parking lot)	69	74	82		The maximum expected traffic noise is reduced to only
Therefore sound level expected in corridor and transfer lounge at NIA	20-21				21 dB in the Transfer Lounge which is lower than the recommended level. Therefore
Recommended sound level in transfer lounge *1	30-35				the precast concrete wall acts as a good sound insulator.
Conclusion on sound insulation value and noise control					ADEQUATE

curtain wall

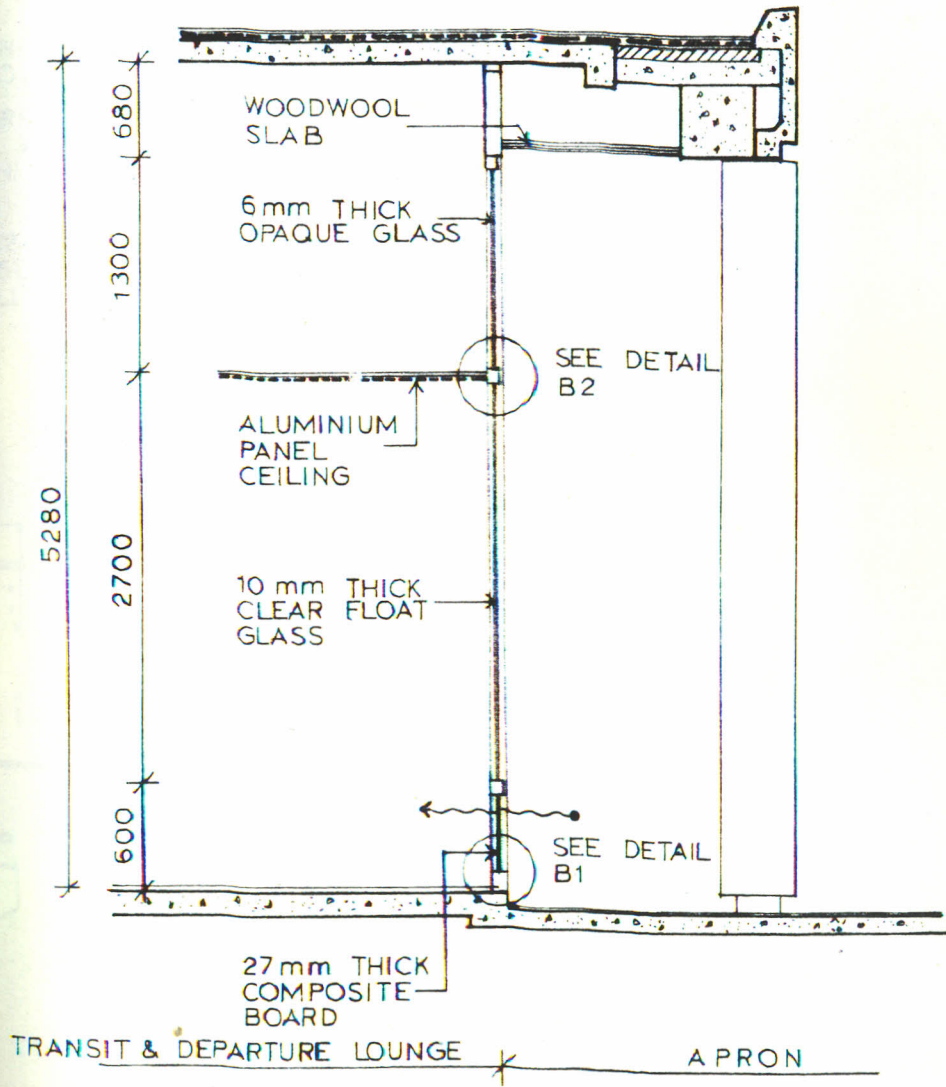

section b - b

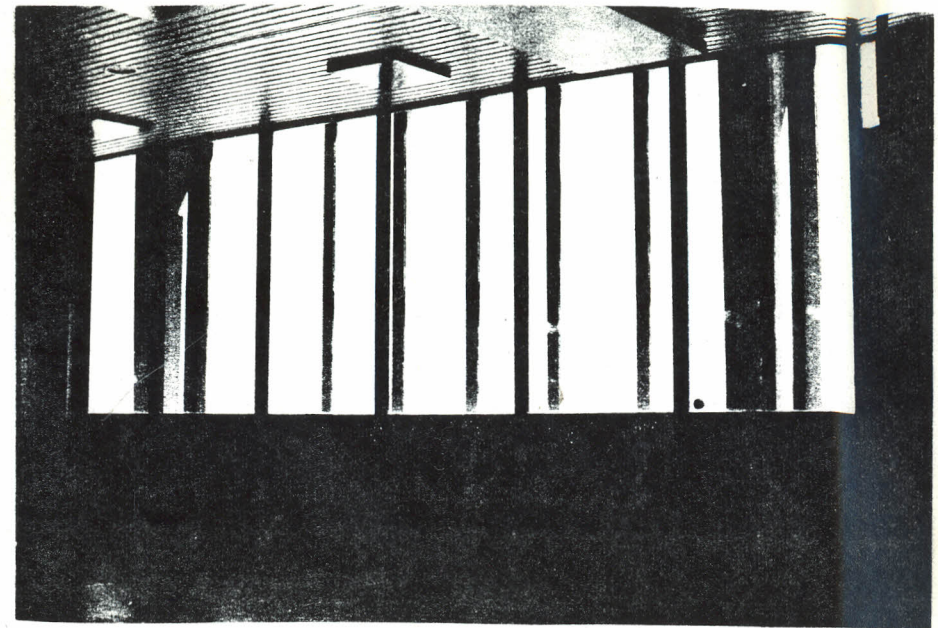

elevation

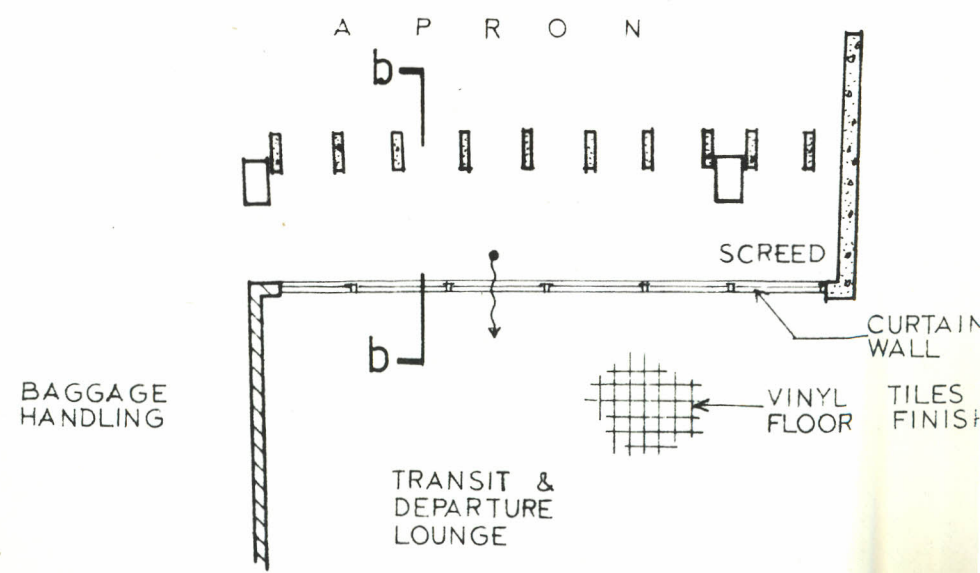

plan

mm THICK
COMPOSITE
GLAZING
BEAD

GLAZING
COMPOUND

mm PRESSED M.S.
GOT WELDED TO
MULLION & BASE
PLATE

mm (12g) PRESSED
BASE STOOLED
MULLION

VINYL
SKIRTING

VINYL
TILES

NC.
CREED

2 NO. EXPANDING
LOOSE BOLTS
12 mm DIAM.

180x180x8
mm M.S. BASE
PLATE WELDED
TO MULLION
BEFORE GALVANISHING

detail B 1

6 mm THICK OPAQUE
COLOURED GLASS

ALUMINIUM SNAP-ON
GLAZING BEAD

ALUMINIUM
PANEL
CEILING

2 mm (14g) PRESSED
M.S. TRANSOME

10 mm THICK CLEAR
FLOAT GLASS

detail B 2

120

20
120
15
65

110
60

90 30

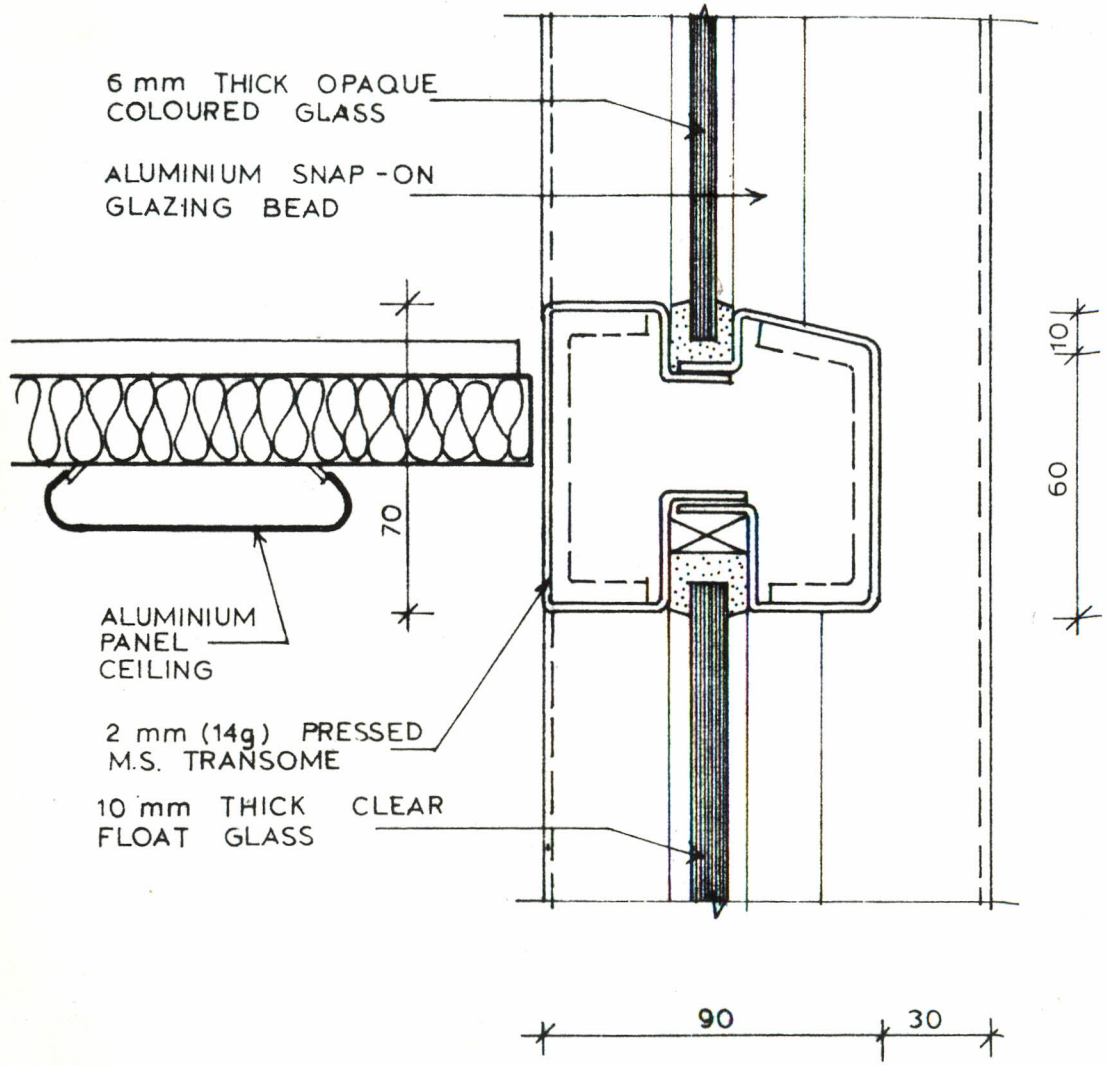
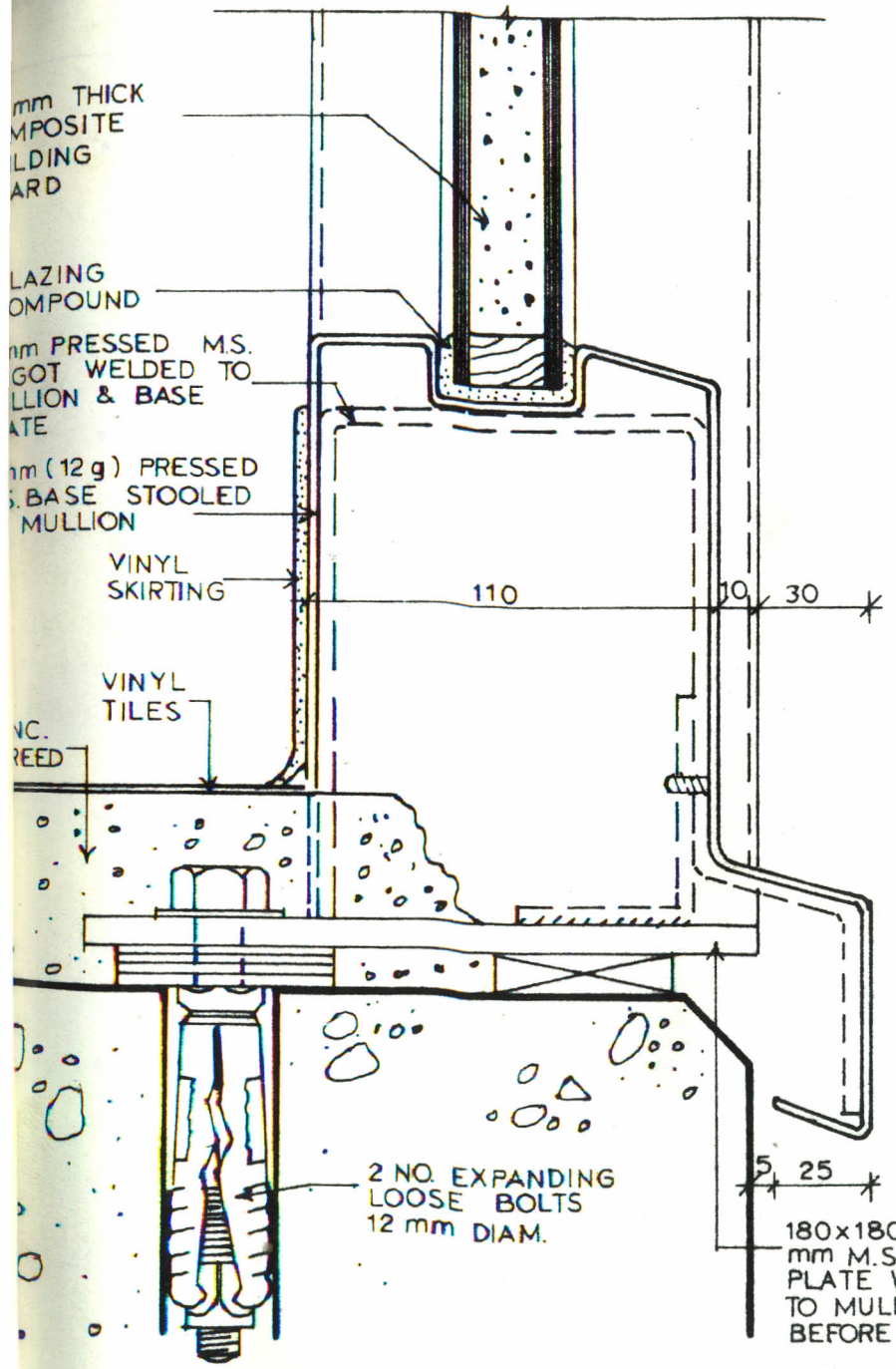

PARTICULARS

A

B

C

EVALUATION

- Sound produced by loudspeaker 1 metre away in open
- Sound coming into transit and departure lounge
- Sound insulation value of curtain wall
- General noise level expected from apron with activities going on (measured at Embakasi Airport)
- Maximum sound level expected from aircraft:
 - taking off
 - landing and parking
 (Boeing 707 at a distance of approx. 100 m)
- Therefore general sound level expected in transit and departure lounge
- Recommended general sound level in public rooms *1
- Maximum sound level expected in lounge from aircraft landing and taking off (planes are parked at least 100 m from lounge - the airbridge is 100 m long)
- Conclusion on sound insulation value and noise control

80

84

88

52

58

63

30

63

65

68

89

89

89

84

86

88

35

30-35

58

The general sound level of 35 dB in the lounge is acceptable

Though the sound level of 58 dB exceeds the recommended maximum sound level of 35 dB it is acceptable in this case. This is because planes will come at intervals and the peak noise level will last for a short time only

cavity wall

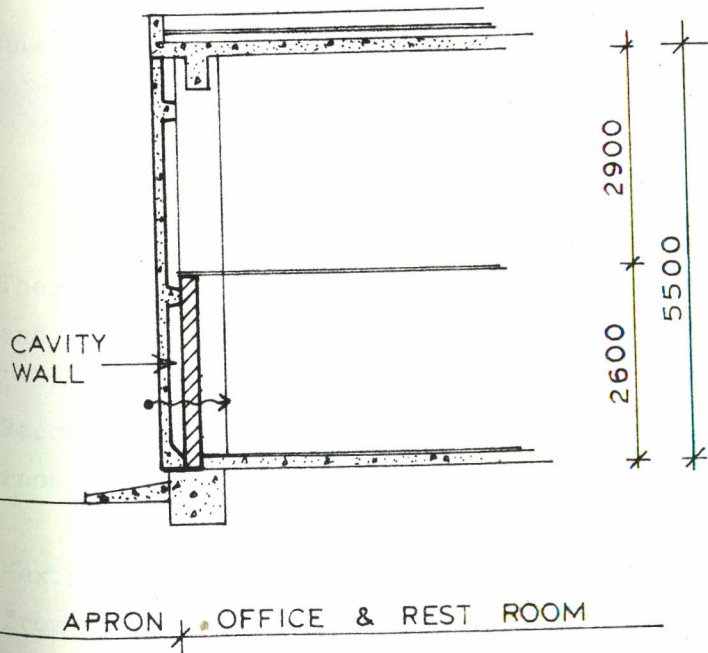

section c - c

SCALE 1:100

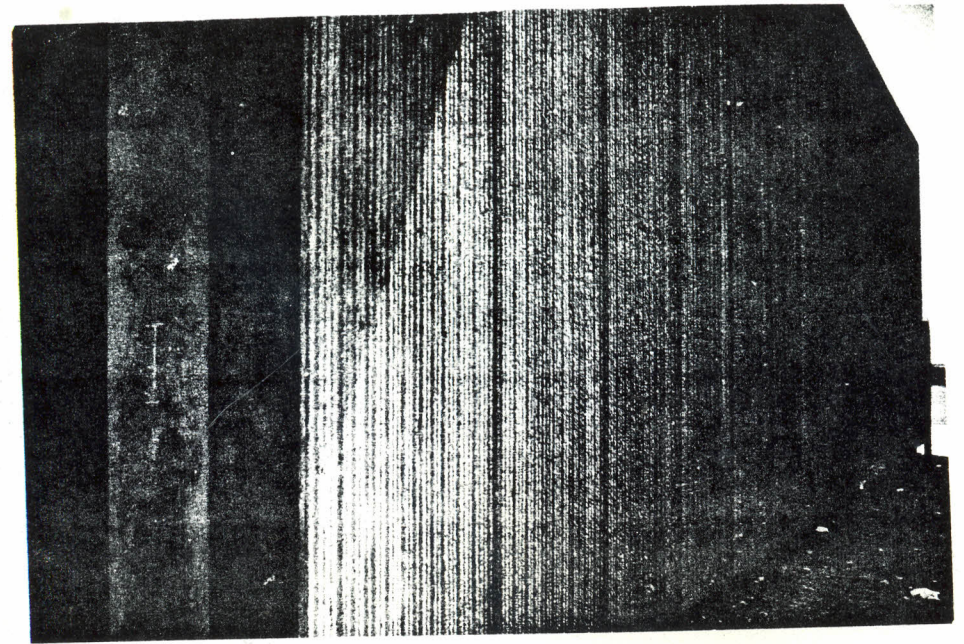

elevation

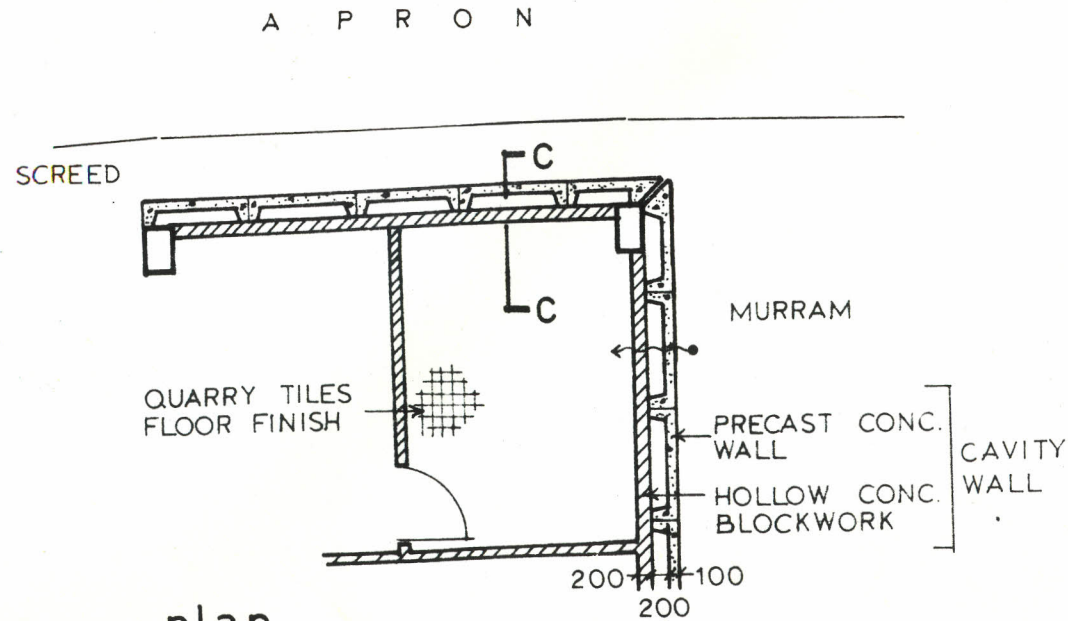

plan

SCALE 1:100

PARTICULARS

A

B

C

EVALUATION

Sound produced by loudspeaker 1 metre away in open

80

83

88

Sound coming in the apron marshaller's office and rest room through cavity wall

40

39

39

Sound insulation value of cavity wall

48

The cavity wall has a high sound insulation value

General sound level expected from apron with activities going on (measured at Embakasi)

63

65

68

Maximum sound level expected from aircraft:

- taking off

89

89

89

- landing and parking

84

86

88

(Boeing 707 at a distance of approx. 100 m)

Therefore general sound level expected in office and rest room

17

Recommended general sound level in office and rest room *1

25-45

Maximum sound level expected in office and rest room from aircraft landing and taking off

41

The cavity wall acts as a good insulator against the general noise coming from the apron and also against the peak noise levels expected during landing and take-off procedures

Conclusion on sound insulation value and noise control

ADEQUATE

partition

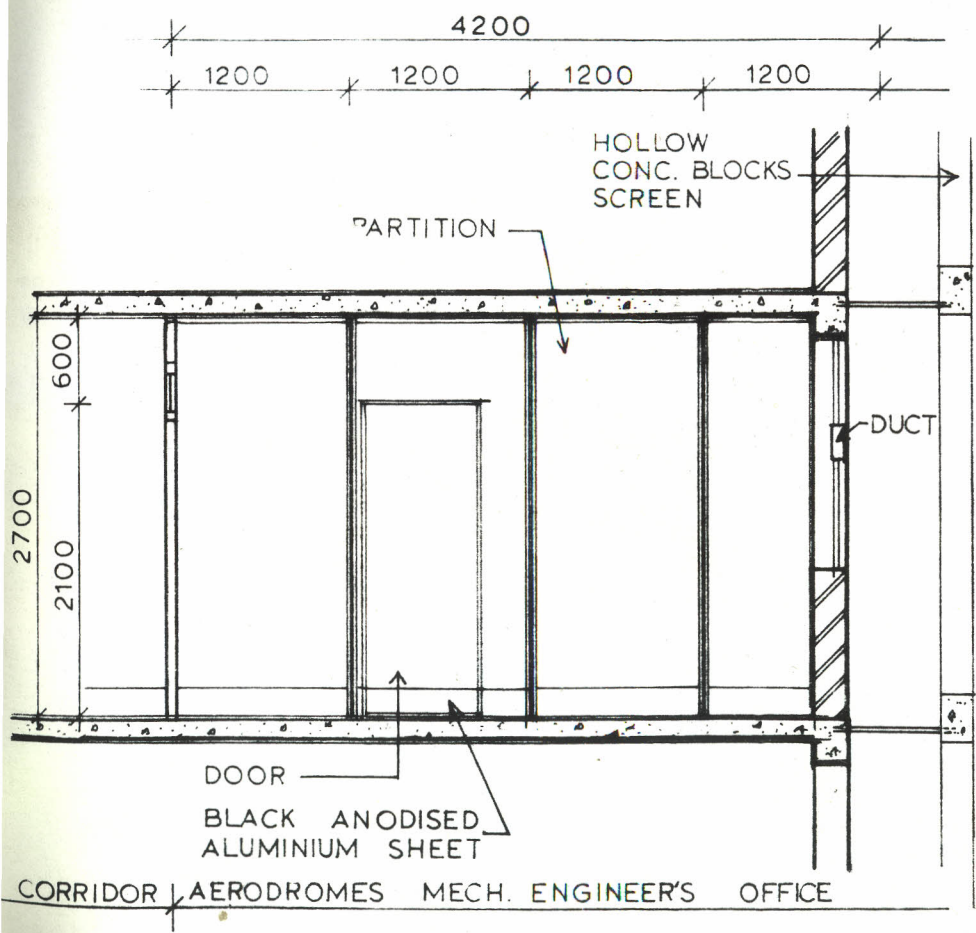

section d - d

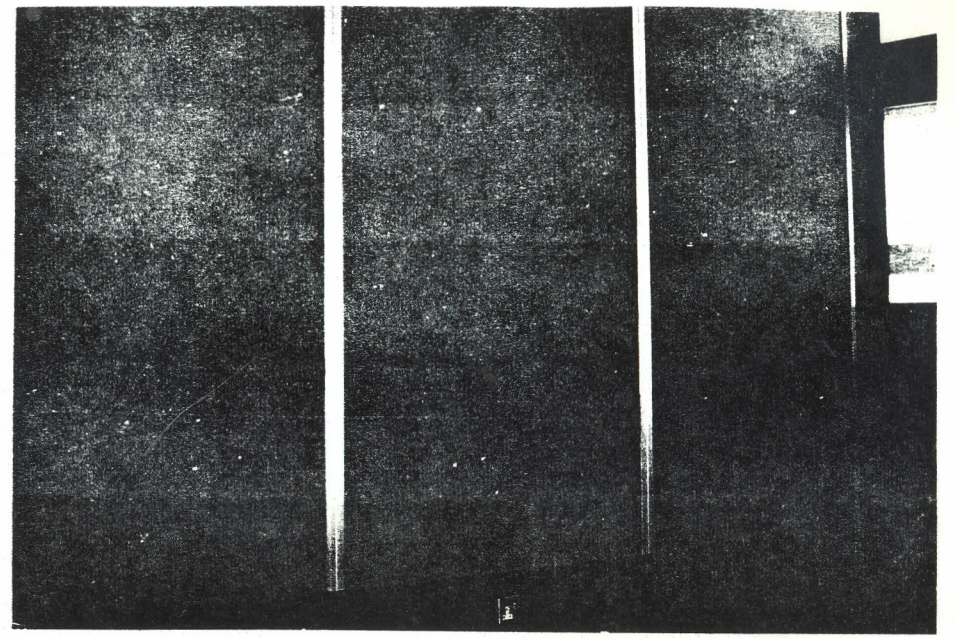

elevation

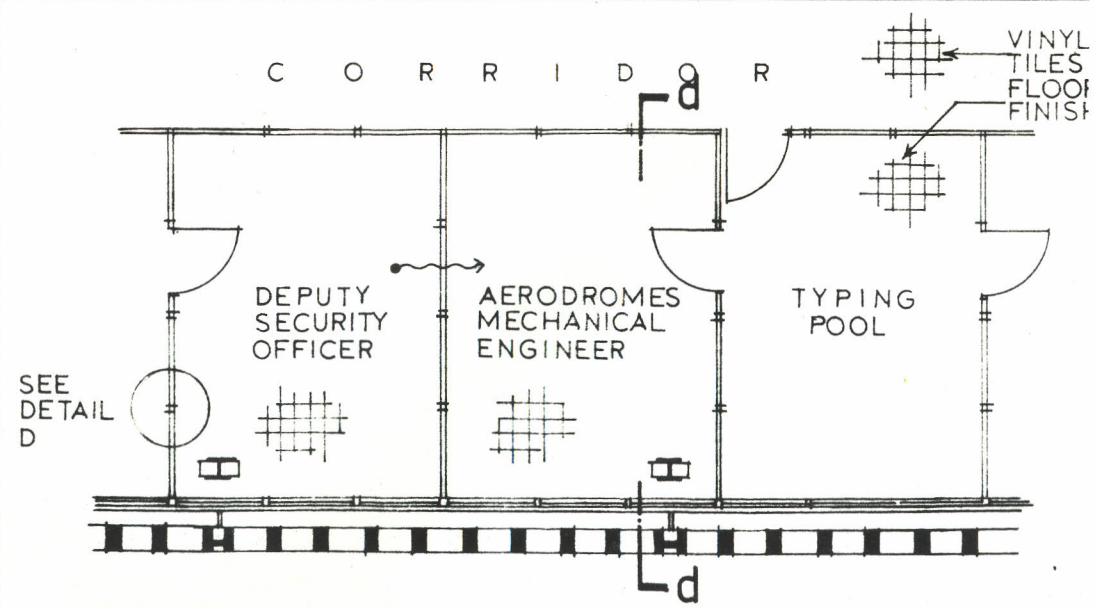

plan

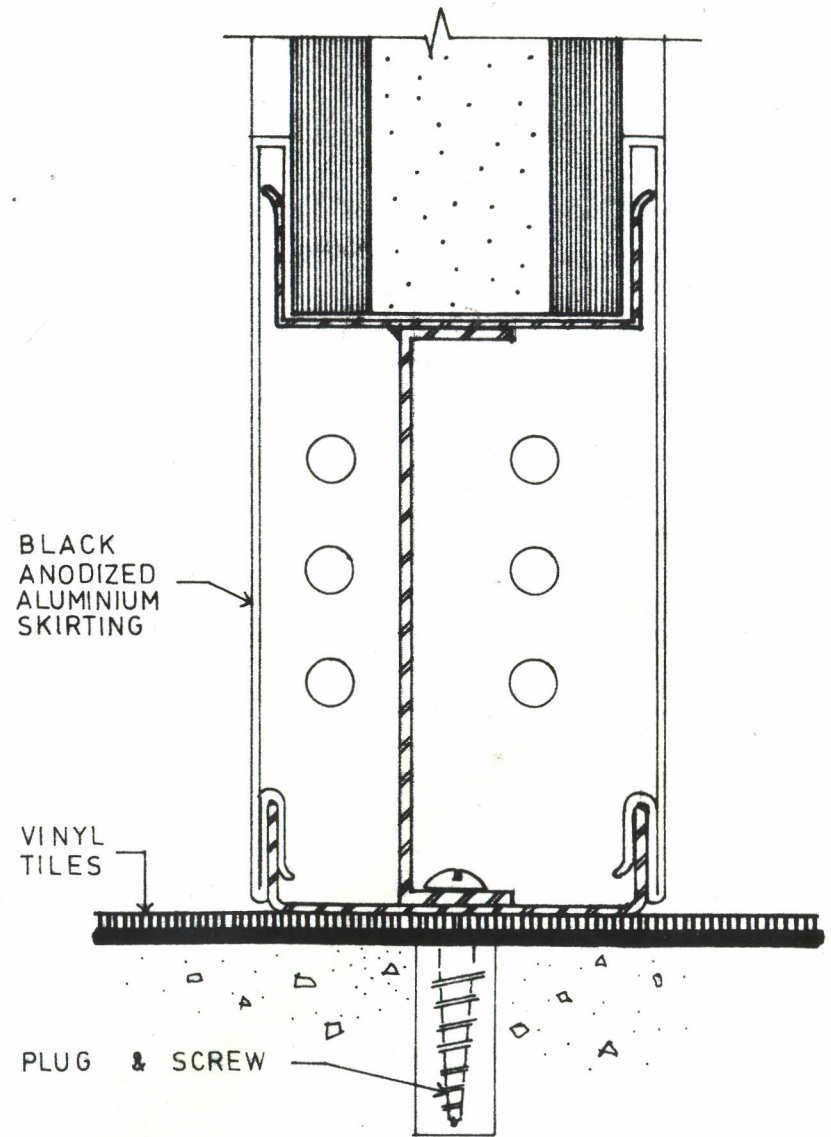
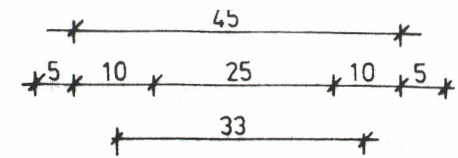
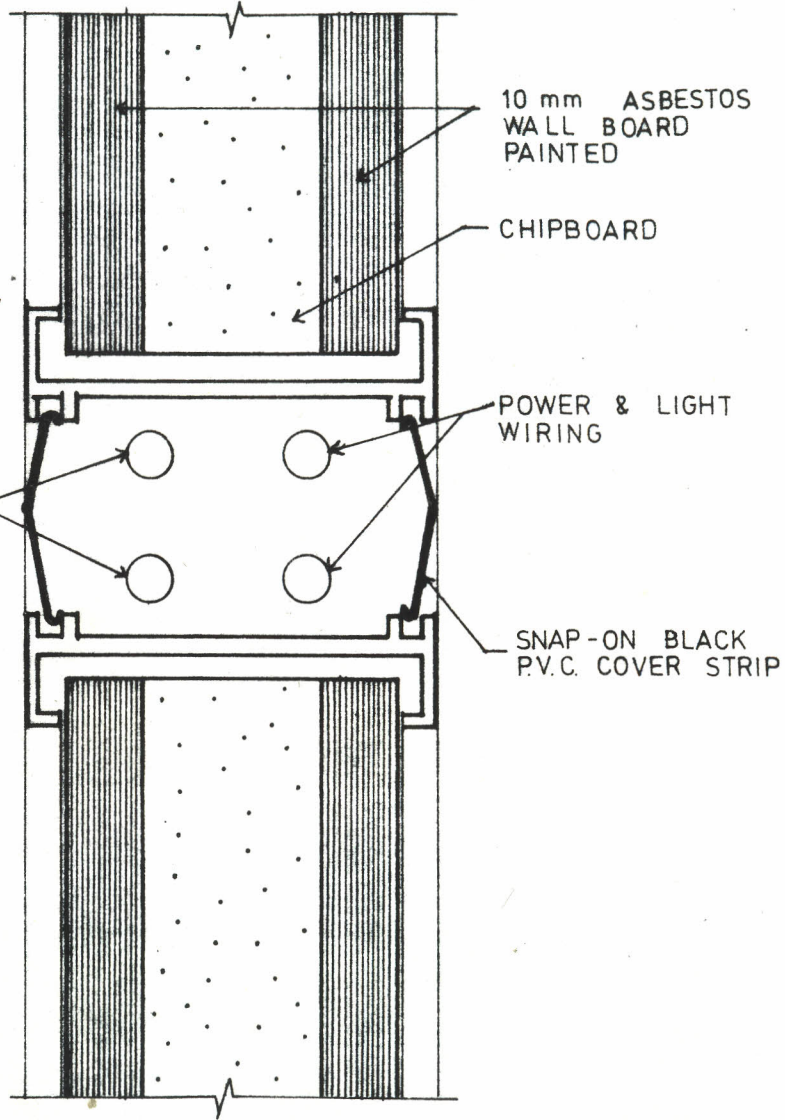
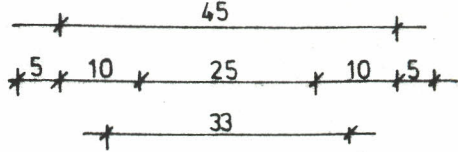

detail D

SCALE 1:1

skirting detail

PARTICULARS

A

B

C

EVALUATION

- Sound produced by loudspeaker 1 metre away in the office
- Sound coming into Engineer's office through partition
- Sound insulation value of partition
- Recommended sound insulation value of partitions between offices *1
- Tests carried out in the laboratory on a 510 x 480 x 45 mm partition:
- Sound produced by loudspeaker 1 metre away
- Sound coming into the 'dead room' through the partition
- Sound insulation value of partition
- Conclusion on sound insulation value and noise control

79

80

84

53

62

63

48

25-35

77

78

78

39

46

55

32

The sound insulation value of 18 dB of the partition is below the recommended sound level.

In order to find out whether it was the partition which was the weak sound insulator I tested a piece of partition in the laboratory for its insulation value

INADEQUATE

COMMENTS AND IMPROVEMENTS

A 510 x 480 x 45 mm piece of the partition (25 mm thick chipboard sandwiched between 10 mm thick asbestos sheets) was tested for sound insulation in the laboratory. The insulation value was found to be 32 dB which is well within the recommended sound value of 25 - 35 dB for partitions between offices *1. Therefore the partition itself is a good sound insulator.

The only places where the sound could leak from are the standard intersection post and the skirting (see Page 24). I have suggested details (see Page 27) on how to improve the insulation value of the post and skirting.

By creating a cavity of 33 mm a good sound insulator could be inserted and at the same time enough space would be left for power, light and telephone wiring.

I tested a 510 x 480 x 33 mm piece of polystyrene in the laboratory and found its sound insulation value to be 11 dB. The insulation value of the partition measured at NIA was found to be 18 dB on the site. This low insulation was mainly due to sound leaking through the intersection post and the skirting.

By improving the intersection post and skirting detail and thus creating a 33 mm cavity which could be filled with polystyrene, an additional insulation value of 11 dB would be provided, giving a total insulation value of 29 dB. This is within the recommended value of 25 - 35 dB *1.

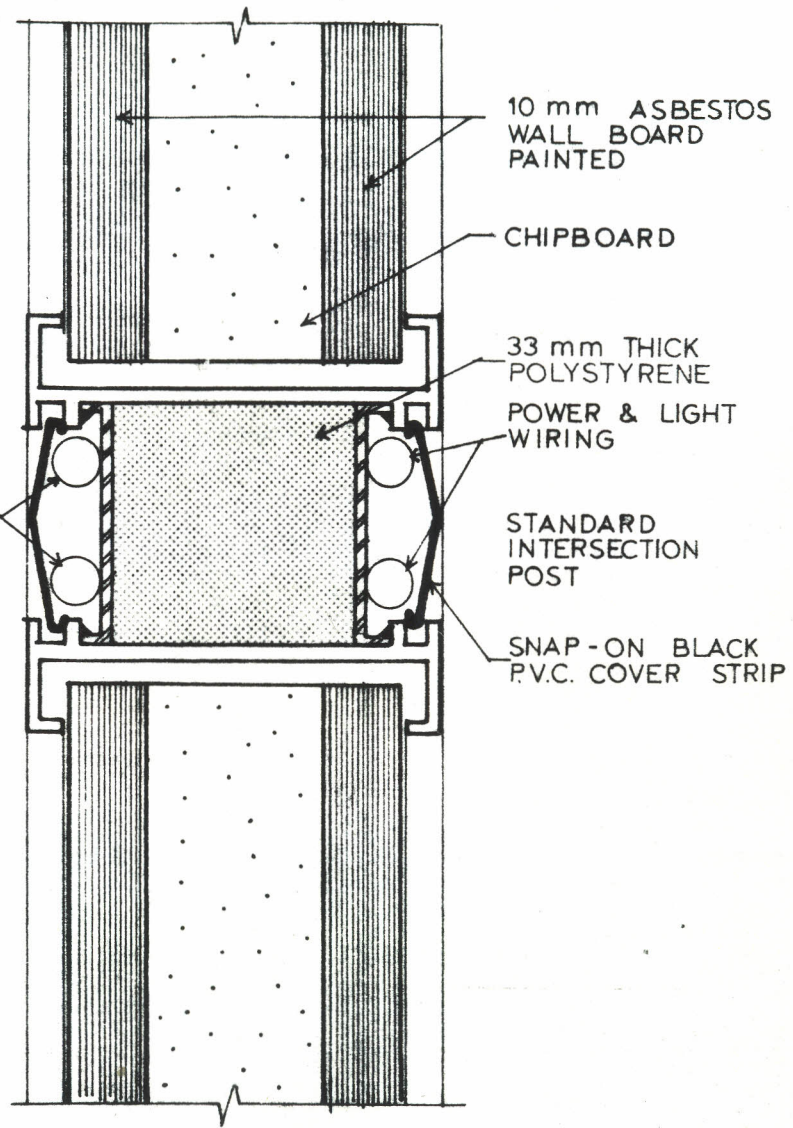
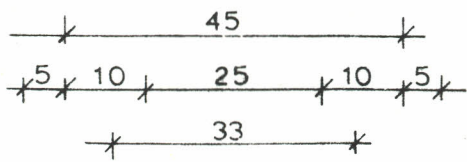

detail D

improved details

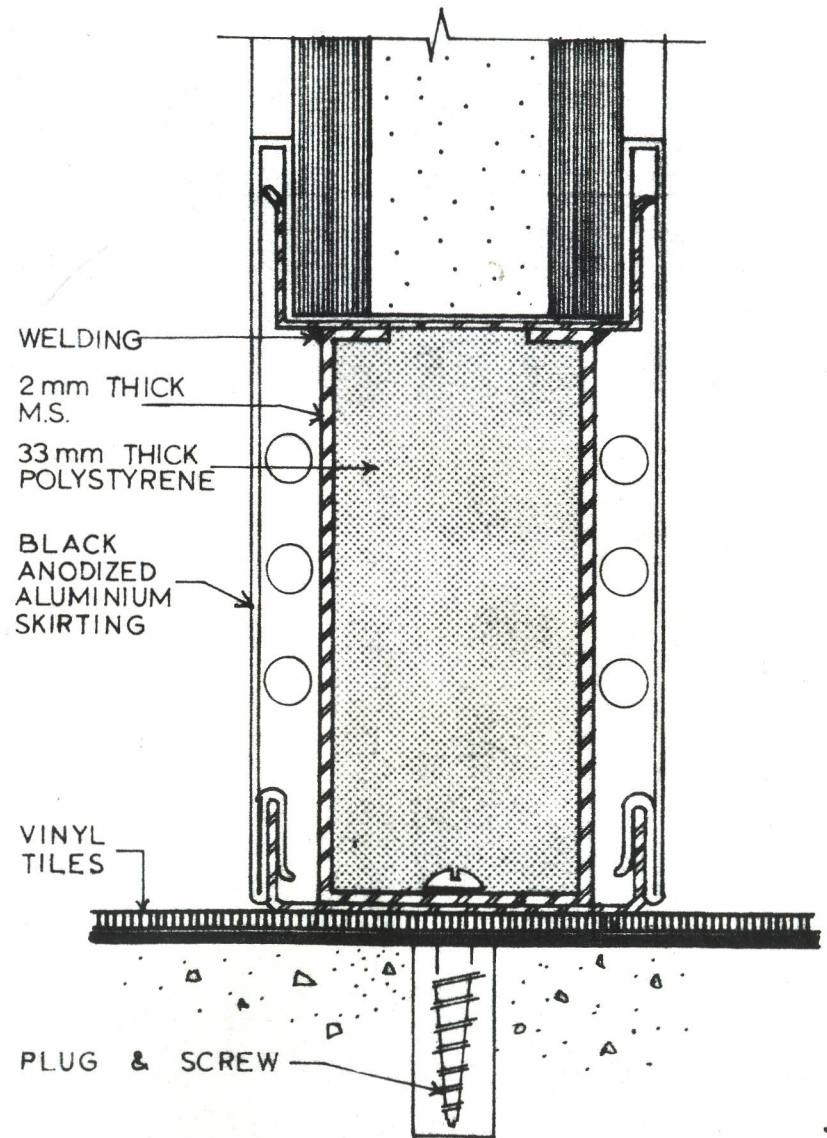
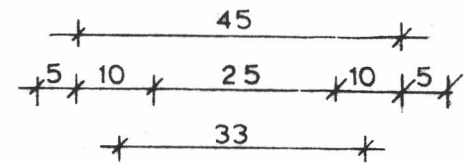

skirting detail

hollow conc. block wall

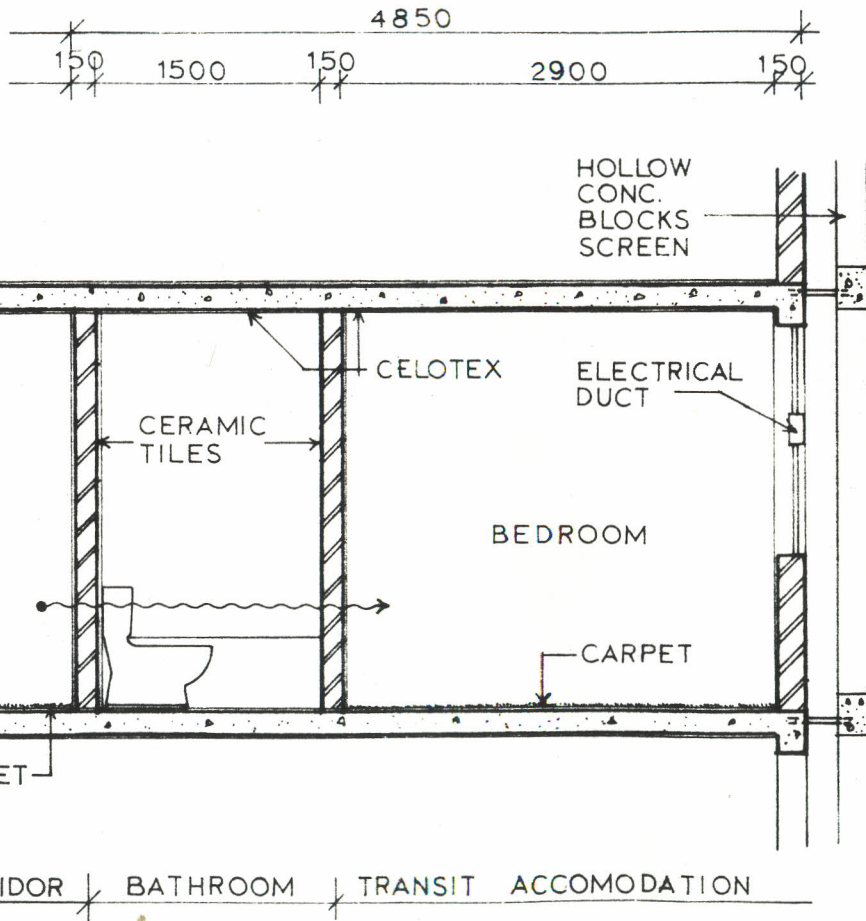

section e - e

SCALE 1: 50

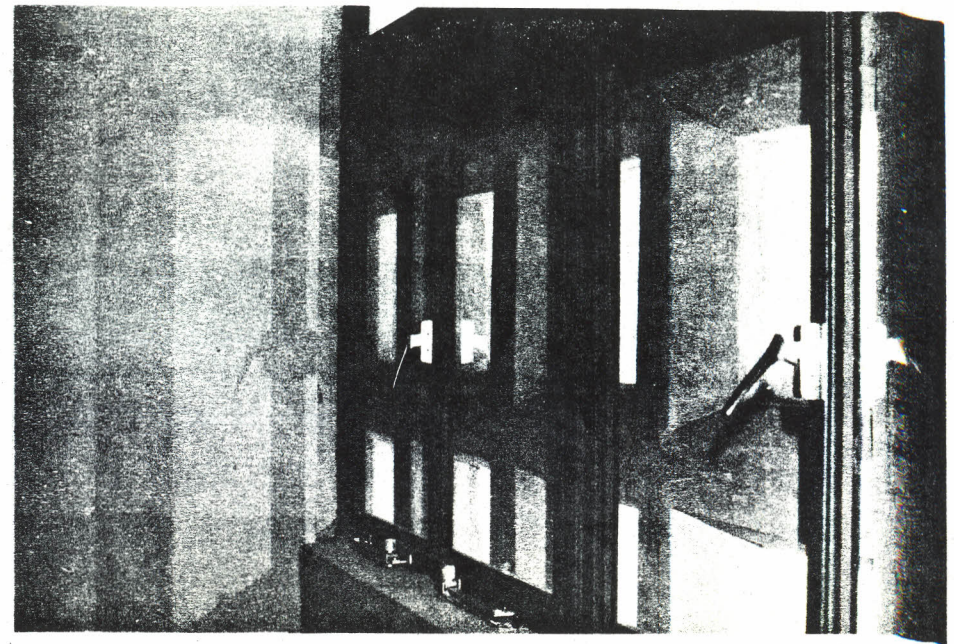

elevation

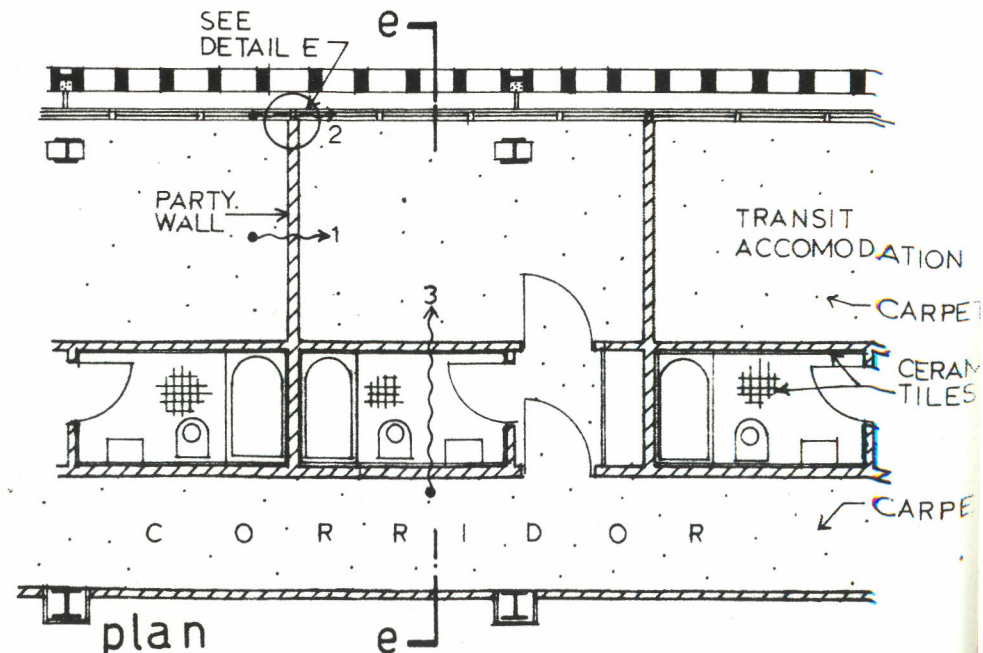

SCALE 1: 100

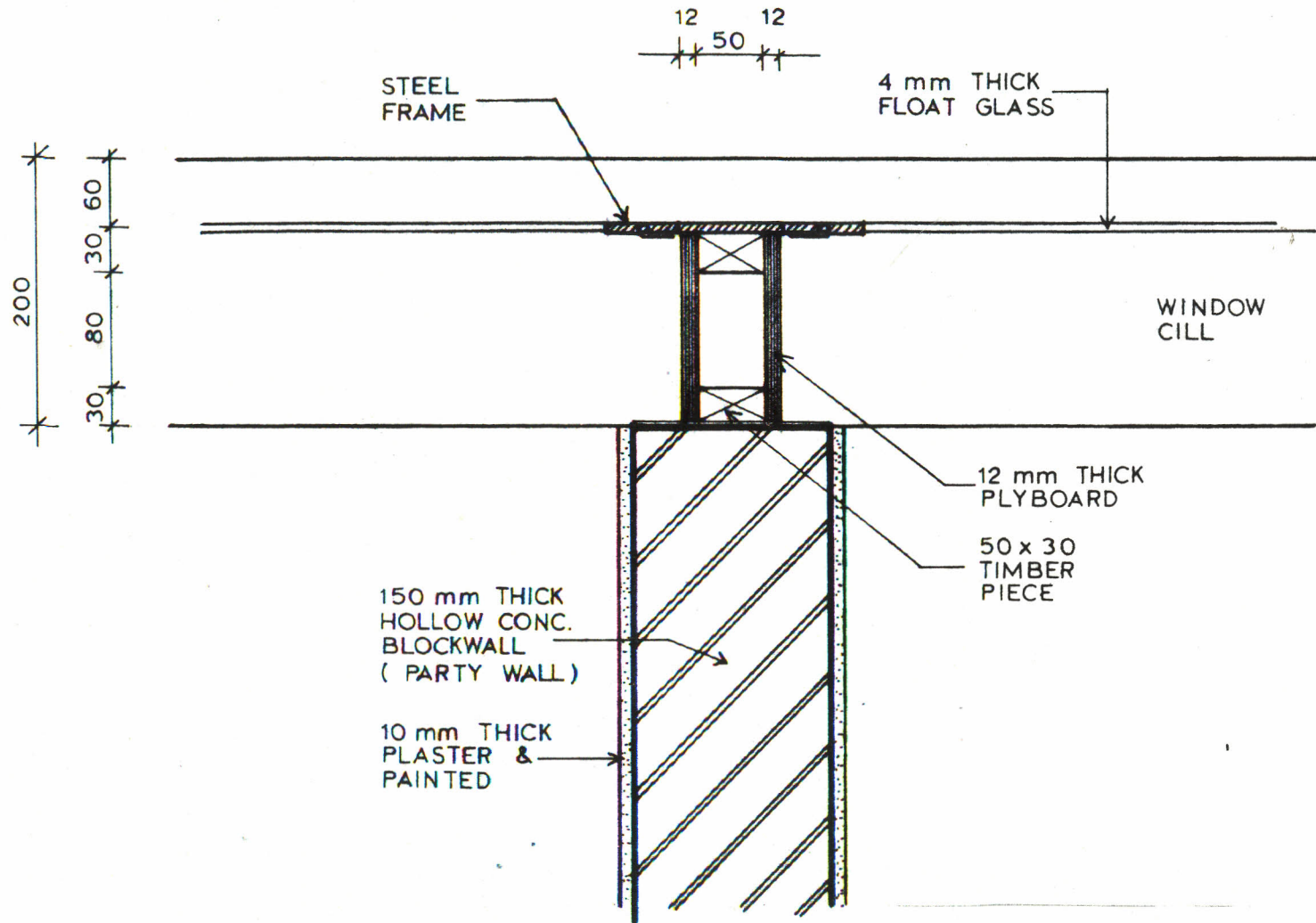

detail E

SCALE 1:5

PARTICULARS

A

B

C

EVALUATION

■ Sound produced by loudspeaker 1 metre away in room

80

83

87

1. Sound coming through blockwall from one room to another

45

54

59

■ Sound insulation value of blockwall

33

For comments see Page 31

■ Sound insulation value of hollow concrete blockwall 150 mm thick *1

45

2. Sound coming through corner detail 'E' of wall

50

59

62

■ Sound insulation value of corner detail 'E' of wall

28

3. Sound coming from corridor, through the bathroom, into the room

32

39

49

■ Sound insulation provided by the bathroom

55

The bathroom acts as a very good sound barrier between the corridor and the bedroom.

■ Recommended insulation values of walls between accommodation rooms

40-45

■ Conclusion on sound insulation and noise control

INADEQUATE

COMMENTS AND IMPROVEMENTS

The 150 mm thick hollow concrete blockwall between the bedrooms was found to have an insulation value of only 33 dB, compared to its actual value of 45 dB *1.

This is mainly due to sound passing through some other way between the bedrooms. A small part of sound leakage can be attributed to the noise passing through the ventilation ducts and through the electrical ducts which run along the window frame.

However, by far the weakest source of sound insulation between the bedrooms is the 'Corner detail E' (see page 29). This detail consists of 2 pieces of 12 mm thick plyboard, which gives an insulation value of only 28 dB. This undermines the good sound insulation value which the blockwall could otherwise give.

The most effective way of providing sound insulation between these bedrooms would be to bring the party wall right through the facades (see fig. 4, page 32). But since all the structural work has been implemented I will suggest an alternative way of improving the sound insulation value of 'Corner detail E' (see page 32).

Instead of the two pieces of 12 mm thick plyboard a 50 mm insulation blanket sandwiched between 13 mm thick gypsum board could be used. This would give a sound insulation value of 44 dB *2, which is within the recommended insulation values *1 between accommodation rooms.

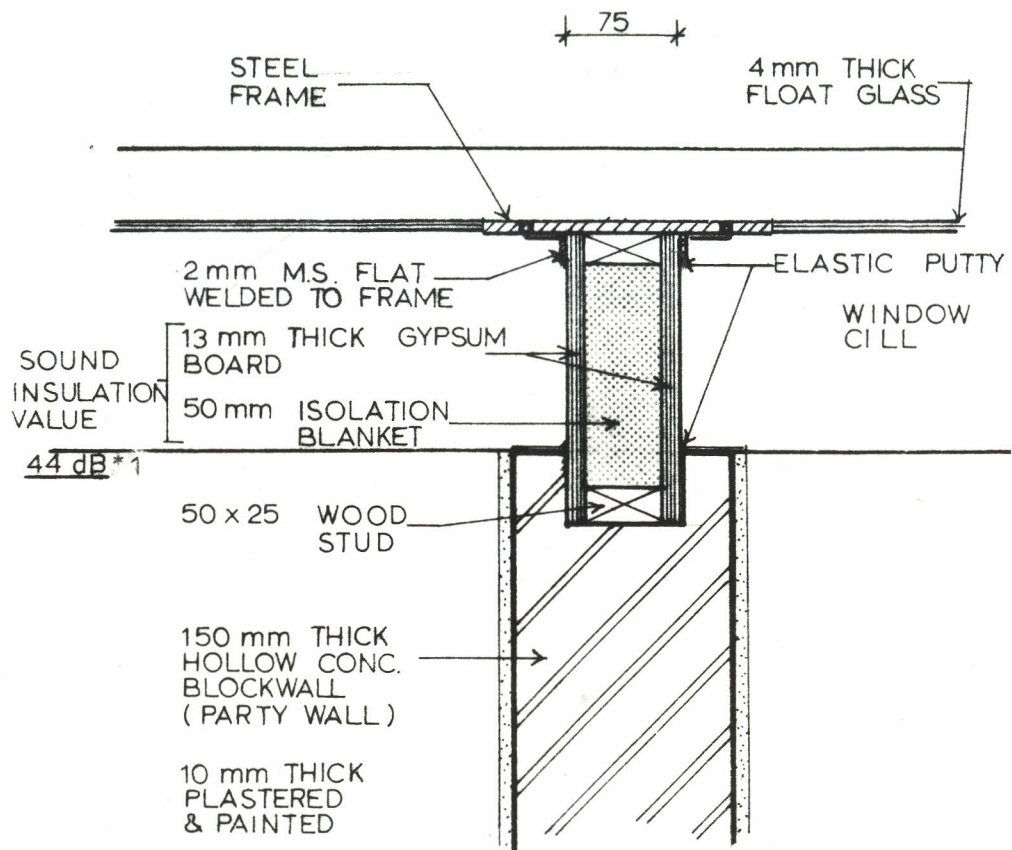
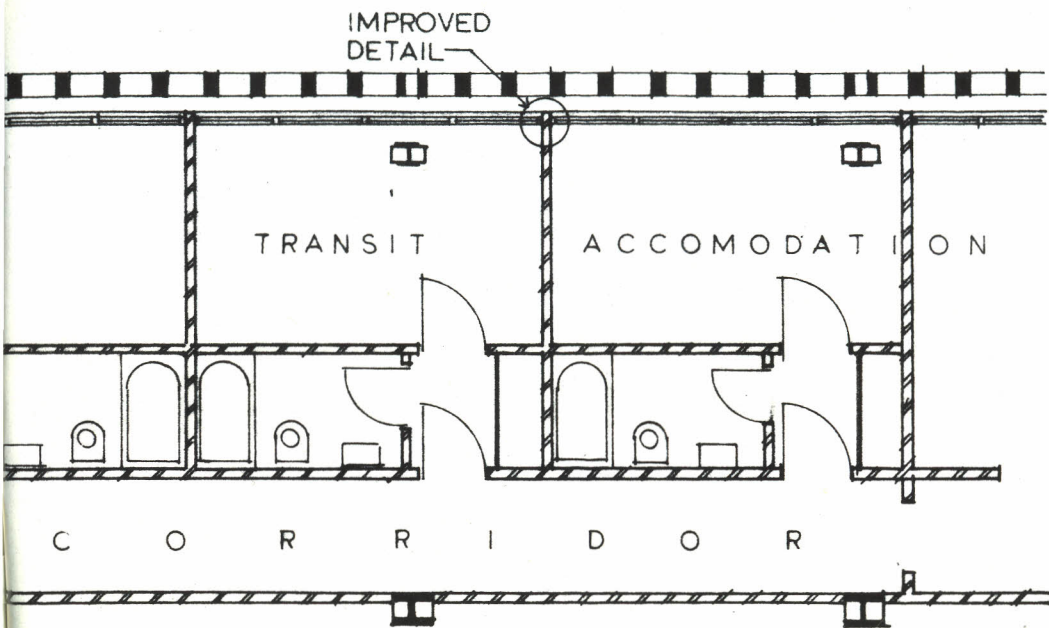

part plan of central terminal
building-level 4

SCALE 1 : 100

FIG. 4

detail E

SCALE 1 : 5

improved details

CONCLUSION

In my opinion this research has been successful in proving my theory, that sound insulation tests should be carried out on building elements where noise control is a critical factor. These tests should be carried out before the completion of the building and the faults rectified before the building is in use.

Out of the five different types of walls and partitions which were tested at Nairobi International Airport, which is nearing completion, two were found to provide inadequate noise control to their immediate surrounds even though sound tests carried out in the laboratory on 510 x 480 panels of similar thickness to those particular elements had much higher insulation values.

One of them was the partition between the offices on level 4 of the Central Terminal building. Though the partition itself had good sound insulation, it performed poorly because of the standard intersection posts between the partition panels and the skirting, through which most of the sound passed.

The other place was at the junction where the party wall between the bedrooms (again on level 4 of the Central Terminal building) and the parapet wall meet. The 140 mm space left between the end of the blockwall and the window frame has been filled in with plyboard. Most of the sound leaks through the plyboard, thereby rendering the overall insulation value of the blockwall poor.

This research has been able to show how small details are often overlooked, and how these details could undermine the overall sound insulation values of building elements.

BIBLIOGRAPHY

- *1 Environmental Acoustics by Leslie Doelle
- *2 Acoustics, Noise and Building by P.H. Parkins and H.R. Humphreys
- *3 Insulation Handbook by Lomax and Erskine
- *4 Insulation of Buildings by R.M.E. Diamant