

University of Nairobi

School of Computing and Informatics

INVESTIGATING WHETHER THE 802.11E WLAN QOS STANDARD PROVIDES OPTIMAL
PERFORMANCE IN CONVERGED NETWORKS

by

Stephen Kinyua Gachogu

(P56/66971/2011)

A research project submitted in partial fulfillment of the requirements for the degree of
Master of Science in Information Systems

Project Supervisor: Mr. Eric Ayienga

Year 2013

DECLARATION

I declare that this work has not been previously submitted and approved for the award of a degree by this or any other university. To the best of my knowledge and belief, the thesis contains no material previously published or written by another person except where due reference is made in the thesis itself.

Signature:

Date:

Stephen Kinyua Gachogu

Reg. No. P56/66971/2011

APPROVAL

This research project has been submitted as part of fulfillment of requirements for the Master of Science in Information Systems with my approval as the supervisor:

Signature:

Date:.....

Mr. Eric Ayienga

School of Computing and Informatics

University of Nairobi

ABSTRACT

The performance of WLANs has tremendously improved achieving speeds that were only witnessed in the competing wired networks. This has resulted to the adoption of WLANs in converged networks supporting both the low and high priority traffic like VoIP. With the voice, video, business data, and background traffic convergence, a key concern in the WLANs is to offer differentiated services.

Though this can be achieved through the 802.11e QoS standard, it is however done at the expense of less-priority traffic such as HTTP and FTP. This research explored the EDCF – the QoS mechanism for WLANs MAC layer and studied the parameters such as minimum and maximum contention windows (CW_{min} & CW_{max}), arbitration inter-frame spacing (AIFS), and transmission opportunities (TXOP), that are used in the implementation of the QoS algorithm. This study has demonstrated that if these parameters are not optimally configured, this can result to starvation of the low-priority traffic.

This research was performed in a simulated WLANs environment using OPNET modeler where three scenarios with same physical and MAC parameters but varying QoS settings were created. We first examined the performance of low-priority traffic in a non-QoS enabled network using DCF. We later enabled QoS using HCF and evaluated the impact of high-priority traffic (with QoS enabled) on low-priority-traffic in a converged network and finally observed the performance of low-priority traffic after modification of the HCF settings.

From the results of the simulations, it was observed that the DCF's overall performance was marginally better in terms of providing fairness for the transmission of all traffic. Whereas the EDCF performed extremely well in provision of differentiated services, the low-priority traffic on the other hand considerably suffered from diminishing resources tending to starvation. This was observed through QoS indicators such as delay, packet loss, and throughput.

ACKNOWLEDGEMENTS

I would wish to express my sincere appreciation to the project supervisor, Mr. Eric Ayienga for all the guidance and valuable inputs in writing this project from the early stages of conceptualization of the project idea to the final stages of project completion.

I would also like to thank my wife, Beatrice for her encouragement and understanding and my two children Cecilia and Gachogu for always being around throughout the study period. Without your company, this work would not have been this successful. I would also like to thank my brother, Irungu for always urging me on.

And to everyone else who contributed in their special ways, thank you all!

TABLE OF CONTENTS

DECLARATION.....	ii
ABSTRACT	iii
ACKNOWLEDGEMENTS	iv
LIST OF FIGURES.....	viii
LIST OF TABLES	ix
LIST OF ABBREVIATIONS AND IMPORTANT TERMS	x
CHAPTER 1 INTRODUCTION.....	1
1.1 Background to the problem	1
1.2 Problem statement and purpose of the project.....	1
1.3 Research outcomes and their significance to key audiences	2
1.4 Research question/hypotheses/objectives.....	2
1.4.1 Research question	2
1.4.2 Research hypothesis.....	3
1.4.3 Research objectives.....	3
1.4.4 Assumptions limitations of the research	3
1.5 Thesis organization	3
CHAPTER 2 LITERATURE REVIEW	4
2.1 Introduction	4
2.2 Growth of wireless networks	4
2.3 Wireless and mobile Networks	4
2.4 IEEE 802.11 WLANs architecture.....	6
2.5 Ieee 802.11 Mac protocol.....	7
2.5.1 IEEE 802.11 CSMA/CA	7
2.5.2 CSMA/CA: RTS and CTS.....	9
2.5.3 IEEE 802.11 Frame Format.....	10
2.6 Quality of service (QoS).....	11
2.6.1 Quality of Service Models.....	11
2.6.2 Real-time Traffic Requirements	12
2.6.3 Challenges on Provision of QoS over WLANs	13
2.6.4 IEEE 802.11 and the Need for QoS	13

2.6.5 Legacy IEEE 802.11 MAC.....	14
2.6.6 Distributed Coordinated Function (DCF).....	15
2.6.7 Point Coordinated Function (PCF)	16
2.7 IEEE 802.11e QoS Support Mechanisms.....	16
2.7.1 HCF Controlled Channel Access (HCCA).....	18
2.7.2 Enhanced Distributed Coordinated Function (EDCF)	18
2.8 EDCA QoS Parameters	20
2.8.1 Arbitration Inter-Frame Space (AIFS)	20
2.8.2 Minimum Contention Window (CW _{min}) & Maximum Contention Window (CW _{max})	21
2.8.3 Transmission Opportunity (TXOP) limit	22
2.8.4 Relationship between AIFSN, CW _{min} /CW _{max}	23
CHAPTER 3 METHODOLOGY	25
3.1 Research design and its justification	25
3.2 MAC protocol QoS parameters and the performance metrics.....	25
3.2 Sources of data/information and relevance of data to the problem.....	25
3.3 Tools, procedures and methods for data collection and their justification	25
3.4 Data analysis methods and their justification	27
3.5 Limitations of methodology and how they are overcome	27
CHAPTER 4: DESIGN	28
4.1 Wireless Network Topology.....	28
4.2 OPNET Modeler	28
4.2.1 OPNET's Project Editor.....	29
4.2.2 Network Nodes	29
4.2.3 Process Editor	30
4.3 Input Data	31
4.3.1 Real-Time Transport Protocol (RTP) Traffic	31
4.3.2 TCP Traffic.....	31

4.4 Process Design.....	31
4.5 Simulation.....	32
4.5.1 Scenario 1	33
4.5.2 Scenario 2.....	33
4.5.3 Scenario 3.....	33
CHAPTER 5: SIMULATION RESULTS AND DISCUSSIONS.....	34
5.1 Simulation Scenario 1: Normal wireless network without any quality of service	34
5.2 Simulation Scenario 2: Impact of EDCAF on different access categories.....	37
5.3 Simulation Scenario 3: Impact of changed QoS Parameters	38
5.3.1 Changing the AIFS Number	39
5.3.2 Changing the size of contention windows	40
5.3.3 Modifying Transmission opportunity (TXOP)	40
CHAPTER 6: CONCLUSIONS & RECOMMENDATIONS	42
6.1 Assessment of the value of this study	42
6.2 Limitations of the research	42
6.3 Conclusions	42
6.4 Recommendations for FURTHER research	43
LIST OF REFERENCE.....	44
APPENDICES.....	47
Appendix A: Project Schedule	47
Appendix B : Statistical Data.....	48

LIST OF FIGURES

<i>Number</i>		<i>Page</i>
1.	Figure 2-1: Mobile cellular subscription	4
2.	Figure 2-2: Wireless components.....	6
3.	Figure 2-3: Hidden node/terminal problem.....	7
4.	Figure 2-4: Fading problem.....	8
5.	Figure 2-5: Steps in CSMA/CA frame transmission.....	9
6.	Figure 2-6: Use of RTS/CTS in minimizing hidden node problem.....	10
7.	Figure 2-7: IEEE 802.11 Frame format.....	11
8.	Figure 2-8: Use of DIFS.....	15
9.	Figure 2-9 HCF access methods.....	17
10.	Figure 2-10 Mapping of 802.11 and 802.11e MAC on the OSI reference model	17
11.	Figure 2-11 Reference implementation model.....	19
12.	Figure 2-12 Relationship between AIFSN, CWmin, and CWmax.....	23
13.	Figure 4.1 WLAN topology	28
14.	Figure 4.2 An illustration of the simulated wireless network topology	29
15.	Figure 4.3 Node structure.....	30
16.	Figure 4.4 Simulation parameters	32
17.	Figure 5.1 Traffic set parameters	34
18.	Figure 5.2 WLAN parameters	35
19.	Figure 5.3 Network throughput.....	35
20.	Figure 5.4 AP Throughput	36
21.	Figure 5.5 Dropped traffic.....	36
22.	Figure 5.6 Delay experienced by different traffic flows.....	36
23.	Figure 5.7 Throughput for voice	37
24.	Figure 5.8 WLAN delay.....	38
25.	Figure 5.9 Packet loss.....	38
26.	Figure 5.10 EDCA parameters	39
27.	Figure 5.11 Throughput on changed AIFSN	39
28.	Figure 5.12 Delay effect on changed AIFSN	40
29.	Figure 5.13 Changing size of CWmin.....	40
30.	Figure 5.14 Modifying TXOP	41
31.	Figure 5.15 Effects of changing TXOP	41

LIST OF TABLES

<i>Number</i>	<i>Page</i>
Table 2-1: Mapping of UP to AC	19
Table 2-2: Default AIFS values for each PHY implementation.....	21
Table 3-1: IEEE802.11e QoS Features and the QoS parameters	25

LIST OF ABBREVIATIONS AND IMPORTANT TERMS

AC: Access Category

AIFS: Arbitration IFS

AP: Access Point

BSS: Basic Service Set

CSMA/CA: Career Sense Multiple Access with collision Avoidance

CW: Contention Window

DCF: Distributed Coordination Function

DIFS: Distributed Coordination Function IFS

EDCA: Enhanced distributed channel access

EDCF: Enhanced Distributed Coordination Function

EIFS: Extended IFS

HC: Hybrid Coordinator

HCCA: HCF controlled channel access

IBSS: Independent basic service set

IFS: Inter Frame Space

MAC: Media Access Control

MMPDU: MAC management protocol data unit

MPDU: MAC protocol data unit

MSDU: MAC service data unit

NAV: network allocation vector

PCF: Point Coordination Function

PIFS: Point Coordination Function IFS

QoS: Quality of Service

RF: Radio Frequency

SIFS: Short Inter Frame Space

TBTT: target beacon transmission time

WAP: Wireless Access Point

WLAN: Wireless Local Area Network

Access Category (AC): A label for the common set of enhanced distributed channel access (EDCA) parameters that are used by a quality of service (QoS) station (STA) to contend for the channel in order to transmit medium access control (MAC) service data units (MSDUs) with certain priorities.

Access Point (AP): Any entity that has station (STA) functionality and provides access to the distribution services, via the wireless medium (WM) for associated STAs.

Basic Service Set (BSS): A set of stations (STAs) that have successfully synchronized using the JOIN service primitives¹¹ and one STA that has used the START primitive. Membership in a BSS does not imply that wireless communication with all other members of the BSS is possible.

Coordination Function: The logical function that determines when a station (STA) operating within a basic service set (BSS) is permitted to transmit protocol data units (PDUs) via the wireless medium (WM). The coordination function within a BSS may have one hybrid coordination function (HCF), or it may have one HCF and one point coordination function (PCF) and will have one distributed coordination function (DCF). A quality of service (QoS) BSS will have one DCF and one HCF.

Enhanced Distributed Channel Access (EDCA): The prioritized carrier sense multiple access with collision avoidance (CSMA/CA) access mechanism used by quality of service (QoS) stations (STAs) in a QoS basic service set (BSS). This access mechanism is also used by the QoS access point (AP) and operates concurrently with hybrid coordination function (HCF) controlled channel access (HCCA).

HCF controlled channel access (HCCA): The channel access mechanism utilized by the hybrid coordinator (HC) to coordinate contention-free media use by quality of service (QoS) stations (STAs) for downlink unicast, uplink, and direct-link transmissions.

Hybrid Coordination Function (HCF): A coordination function that combines and enhances aspects of the contention-based and contention-free access methods to provide quality of service (QoS) stations (STAs) with prioritized and parameterized QoS access to the wireless medium (WM), while continuing to support non-QoS STAs for best-effort transfer. The HCF includes the functionality provided by both enhanced distributed channel access (EDCA) and HCF controlled channel access (HCCA). The HCF is compatible with the distributed coordination function (DCF) and the point coordination function (PCF). It supports a uniform set of frame formats and exchange sequences that STAs may use during both the contention period (CP) and the contention-free period (CFP).

MAC protocol data unit (MPDU): The unit of data exchanged between two peer MAC entities using the services of the physical layer (PHY).

Point Coordination Function (PCF): A class of possible coordination functions in which the coordination function logic is active in only one station (STA) in a basic service set (BSS) at any given time that the network is in operation.

Transmission Opportunity (TXOP): An interval of time when a particular quality station (STA) has the right to initiate frame exchange sequences onto the wireless medium is defined by a starting time and a maximum duration. The TXOP is either obtained successfully contending for the channel or assigned by the hybrid coordinator (HC).

Quality of Service (QoS): The provisioning of service in which the medium access control (MAC) protocol data units (MPDUs) with higher priority are given a preferential treatment over MPDUs with a lower priority. Prioritized QoS is provided through the enhanced distributed channel access (EDCA) mechanism.

CHAPTER 1 INTRODUCTION

1.1 BACKGROUND TO THE PROBLEM

Since the first Wireless Local Area Networks (WLANs) technology was ratified by the IEEE in the year 1999 (IEEE, 2007), tremendous changes and new inventions have occurred, notably we have seen unprecedented advancements in supported bandwidth from the paltry 1Mbps to the current high-speed bandwidth in excess of 200 Mbps supported by Multiple Input Multiple Out (MIMO) on the most recent IEEE 802.11n WLAN technology.

These great changes have continued to impact the society in terms of applications due to the ease of deployment of wireless networks. Enterprises are now converting to wireless networks using the high-speed wireless connections to connect branch offices into what is known as the Metropolitan Area Networks (MANs). Today, most of the mobile and hand-held devices have the WLAN technology already embedded in them and can be used at any point where the wireless signal is available for connectivity to the wider Internet.

With the pervasiveness of the technology, new applications are bound to be developed; the conventional data transmission over wireless is no longer the excitement but the need to transmit all the traffic types including data, voice and video at the required service quality levels.

With the increasingly successful deployment of WLANs, there is a great likelihood that most of the wired networks may be replaced in the future. Wireless networks allow seamless mobility at both layer 2 and layer 3. With the widespread use of multimedia applications, there is need for deployment of end-to-end QoS especially for the real time applications like interactive voice and video.

The first implementation of the IEEE.802.11 standards did not have the QoS features but with the release of 802.11e standard in 2005, new QoS medium Access control (MAC) enhancements were introduced through a new coordination function known as Hybrid Coordination Function (HCF). HCF comes with the Enhanced Distributed Coordination Function (EDCF) which adds transmission prioritization to Carrier Sense Multi-access with Collision Avoidance (CSMA/CA). HCF also introduced a new contention-free media access for QoS stations (STAs) to match the old PCF known as HCF controlled channel access (HCCA).

1.2 PROBLEM STATEMENT AND PURPOSE OF THE PROJECT

The convenience accrued from the adoption of wireless networks and the development in terms of access speeds make the WLANs the technology of choice in enabling connectivity not only to the myriad end user devices but also the other devices and servers on a network.

With the voice, video and data traffic convergence trend, a key concern in the wireless networks continues to be the issue of provision of differentiated services through manipulation of the QoS parameters like delay, jitter and bandwidth.

This research involved a detailed study in a simulated WLAN environment consisting of all the required systems needed to analyze and interpret the traffic patterns in relation to application of differing QoS metrics. The research focused on the Data Link layer of the OSI reference model and specifically on the CSMA/CA which is the MAC protocol used by WLANs.

The results of this research give more insight into the provision of QoS in a WLAN environment. They could further contribute to more research on development of better systems to handle QoS. This research did not focus in building such systems.

The research activity was mainly devoted to the study of such factors as bandwidth, delay, jitter, packet loss, and how they contribute to provision differentiated traffic quality per user expectations.

The research focused on provision of high quality interactive voice communication in a converged environment where the business data, less priority traffic and delay sensitive traffic flows all compete for the limited channel resources. An investigation was done to establish the 'fairness' of 802.11e and 'selfishness' due to the fact that QoS parameters can be altered.

1.3 RESEARCH OUTCOMES AND THEIR SIGNIFICANCE TO KEY AUDIENCES

This research work analyzed the existing IEEE802.11e MAC protocol and tested the response to the application of varying parameters such as the slot time, backoff timers, inter-frame spacing, and the minimum CW_{min} and maximum contention windows that affect provision of QoS.

The research contributes further to the growing study on WLANs by demonstrating results of simulated wireless networks using current WLAN technologies. While these data could be used for further research, the explanation of the limitations of 802.11e QoS will assist in deeper understanding of the standard which could be used to further investigate and improve wireless communication.

The results of this thesis could be used as guideline to stakeholders in the wireless industry in designing and developing more efficient solution that bring about better end user experience in converged network environment offering preferential treatment to high priority traffic and fairness to all traffic types.

1.4 RESEARCH QUESTION/HYPOTHESES/OBJECTIVES

1.4.1 Research question

This research project sought to answer the question on whether or not the IEEE802.11e MAC protocol provides the optimum QoS operation in a converged network environment providing preferential treatment to high priority traffic and at the same time offering fairness to the low priority traffic.

1.4.2 Research hypothesis

Considering the varying wireless network applications, intelligent tuning of QoS parameter on 802.11e MAC can mitigate the unfair treatment of the less priority traffic which could lead to resources starvation.

1.4.3 Research objectives

Taking into account of the expected growth of wireless LANs applications and the move towards convergence of all traffic types on a single physical infrastructure, this research sought to address the following key objectives:

1. To research on the attributes of the MAC layer protocol that contribute to the provision of quality of service (QoS) for real-time traffic like voice.
2. To study the current IEEE 802.11e quality of service standard in respect to how it handles real-time traffic in terms of priority treatment and fairness to other less priority traffic types.
3. To investigate the 'fairness' and 'selfishness' that can arise from the 802.11e QoS mechanisms.
4. To develop a simulated wireless network model to be used to experiment the effects of QoS in a converged environment.

1.4.4 Assumptions limitations of the research

This research was done on simulated networks and it was assumed that the simulation model would not introduce error on the interpretation of the operation of the 802.11 MAC protocol. The simulated tests also assume ideal environment free of interference from weather factors and no mobility on mobile stations. The accuracy of the research results therefore are dependent on the accuracy of the simulation model used.

1.5 THESIS ORGANIZATION

Chapter 2 reviews the literature surrounding the WLANs and the QoS implementation on wireless LANs.

Chapter 3 discusses the tools used to simulate the network.

Chapter 4 focuses on the implementation of the of the network setup that was used later in the observation and the analysis of the operation of wireless LANs.

Chapter 5 analyzes the MAC QoS attributes implemented in a simulated WLAN environment.

Chapter 6 summarizes the thesis, draw some conclusions and offers some recommendation on future QoS over WLANs in a converged network.

CHAPTER 2 LITERATURE REVIEW

2.1 INTRODUCTION

In this chapter a review of literature was carried out under the following subtopics: WLANs and Quality of service, it also covered the investigation on the operations and differences between the IEEE802.11 standard and the IEEE802.11e standard for the QoS. Finally a review of related work the IEEE802.11e quality of service standard for the wireless LANs was made.

2.2 GROWTH OF WIRELESS NETWORKS

The use of wireless access technology has consistently grown with figures in mobile access exceeding six (6) billion subscribers according to ITU report of telecommunications access (ITU, 2011). Figure 2-1 below from the same report gives a clear indication that wireless networks will continue to impact on the future access technologies, the wireless technology is now available on virtually every mobile device including the laptops, PDAs, palmtops, Smart Phones with providing untethered access from anywhere at any time. The number of wireless subscribers has surpassed the wired access subscribers.

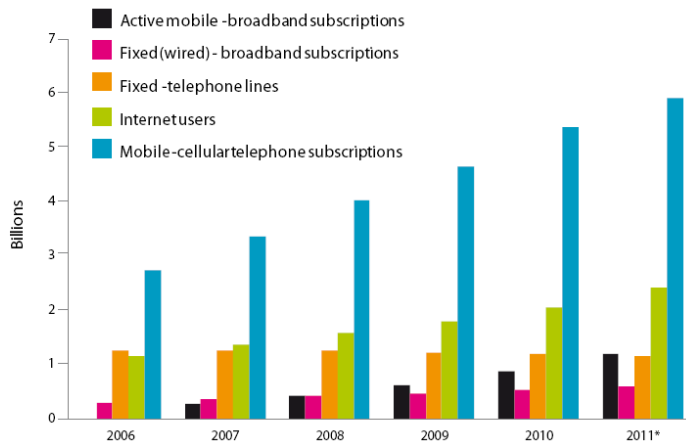

FIGURE 2.1 MOBILE CELLULAR SUBSCRIPTION

2.3 WIRELESS AND MOBILE NETWORKS

Wireless access technologies in the market today include the 802.11 (WLANs) – the focus of this study, Bluetooth , WiMAX, Satellite communication technologies and the Mobile cellular technologies like the GSM, LTE etc.

A wireless network consists of the following components (Kurose, 2007):

- **Wireless host.** These are the end user devices that run applications. They are usually loaded with hardware and software drivers that enable them access the wireless network. Wireless devices might include a laptop, palmtop, personal digital assistant or even a desktop computer.
- **Network Interface Cards (NICs) /Client Adapters.** Wireless client adapter connect PC or Workstation to a wireless network either in ad hoc (infrastructure less) peer-to-peer mode or in infrastructure mode with APs. It is available for two kinds of slots PCMCIA (Personal Computer Memory Card International Association) card and PCI (Peripheral Component Interconnect), it connects desktop and mobile computing devices wirelessly to the whole network. The NIC scans the available frequency spectrum for connectivity and associates it to an access point or another wireless client. It comes with a software driver that couples it to the PC operating system.
- **Wireless communication link.** This is the radio frequency channel over which the wireless devices access the network. Different wireless links offer varying bandwidths and signal transmission distances. A WLAN link can span a distance of 30 to 100 meters supporting speeds of over 200 mbps. The supported bandwidths depend on several factors such as distance, channel condition and the number of users in the network. Wireless links can connect the device to other wireless devices and even to the larger wired corporate, home network or the Internet. The link can also be used to connect other devices such as router and switches.
- **Base station.** This is the device responsible for sending and receiving traffic from the wireless hosts, it is also responsible for coordinating transmission of the various wireless devices with which it is associated.- this constitutes a service set. Devices associate with the base station if they are within the wireless communication of the base station and if they are successfully authenticated.

If the base station is used to enable communication between the devices – the communication model is known as the infrastructure mode otherwise. Basic Service Set (BSS): Mobile clients use a single access point for connectivity to each other or to wired network resources. In an Extended Services Set (ESS) two or more Basic Service Sets are connected by a common distribution system (DS). An ESS generally includes a common SSID to allow roaming from access point to access point without requiring client configuration.

If the devices are communicating without a base station this is known as the ad hoc mode or Independent Basic Service Set (IBSS). Mobile clients connect directly without an intermediate access point.

The base station also handle the handoff which is the process of shifting association from one base station to another when the signal attenuates. The figure below shows the interconnections of the wireless components explained above.

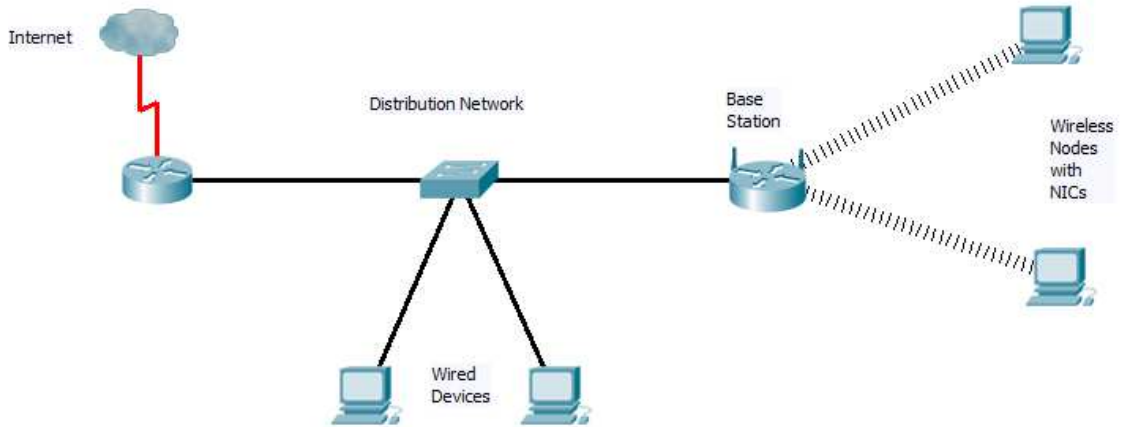

FIGURE 2.2: WIRELESS COMPONENTS.

- (a) Network Infrastructure. The base station is connected with the larger network known as the distribution network with which it communicates. This network may include switches and routers for the corporate network on Internet link.

2.4 IEEE 802.11 WLANS ARCHITECTURE

The fundamental building block of an 802.11 network is the Basic Service Set (BSS) which consists of one or more wireless nodes and a central base station known as the access point (AP). In a corporate or home network, the AP finally connects to router/switch which subsequently connects to rest of the internetwork. The BSS is also referred to as cell – the area serviced by a single wireless AP. The wireless nodes have globally unique 6-byte MAC address. As noted earlier, wireless networks that deploy base stations are referred to as infrastructure wireless LANs where the ‘infrastructure’ refers to the AP and the associated Ethernet network.

Mobile nodes can also form a network by themselves without the deployment of an access point. This kind of network also known independent basic service set (IBSS) network, can be formed when there are several wireless nodes that want to exchange information.

For devices to send traffic on the wireless network, they must be associated with the WAP in the network, identified using service set identifier (SSID) that they would wish to join. Devices also must choose a frequency channel over which to communicate. For the wireless networks these channel fall in the unlicensed frequency band. According to

the IEEE (2007), the following frequency ranges range should be made available for wireless communication: 2.400-2.485 GHz, 5.1 – 5.8 GHz. Devices associate with the AP using the following methods:

- (a) Passive scanning - The AP periodically sends beacon frames that include the AP's SSID and the MAC address, the wireless clients scan the 11 channels and associate with one of the detected AP.
- (b) Active scanning - The client send probe requests that are received by all AP that are within the wireless coverage area. APs respond with probe response frame from which the wireless node chooses one AP to associate with.

2.5 IEEE 802.11 MAC PROTOCOL

To coordinate transmission of data from several senders that may want to do it simultaneously, a media access mechanism is needed. Kurose et al. (2007) have classified media access protocols in to three categories: channel partitioning (including CDMA), random access. Wireless networks use a random access method known as CSMA with collision avoidance (CSMA/CA).

2.5.1 IEEE 802.11 CSMA/CA

CSMA/CA uses collision avoidance technique because for a station to detect collision, it must be able to determine that another station is transmitting. Because of the low signal strength, it is costly to build adapters that detect collision in wireless.

Another reason for deploying the collision avoidance protocol is because of the hidden node and fading problems. Hidden node problem occurs due to presence of barriers in the wireless environment while fading is as a result of weakening of the signal strength as illustrated the figure 1.4 below.

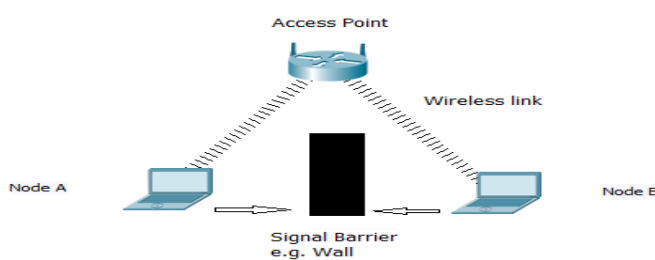

FIGURE 2-3: HIDDEN NODE/TERMINAL PROBLEM

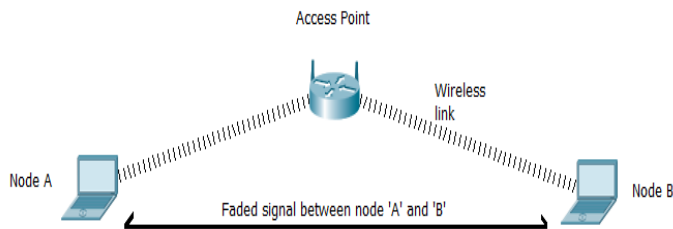

Figure 2-4: Fading problem

When a node gets a chance to transmit, it send the entire frame, the receiving STA waits for a short inter-frame spacing (SIFS) and sends an acknowledgement (ACK). If the transmitting STA does not receive an ACK within a given period, it assumes that an error occurred and retransmits the same frame. If the transmitting station fails after a specified number of attempts, it gives up and discards the frame. The following steps are followed in 802.11 frame transmission:

- (i) Before a station begins to transmit, it senses the idle channel, waits for a short period of time known as distributed inter-frame spacing (DIFS).
- (ii) The station chooses a random backoff value and counts down to zero then it transmits the entire frame.
- (iii) If the channel is sensed busy, the backoff timer is frozen. Upon receiving the valid frame, the receiver waits for the SIFS period and sends an ACK.
- (iv) If an ACK is received and the transmitting station has more data to send, it begins the CSMA/CA from step (ii). If no ACK is received, the transmitting station begins from the same step (ii) but this time using a higher random backoff value.

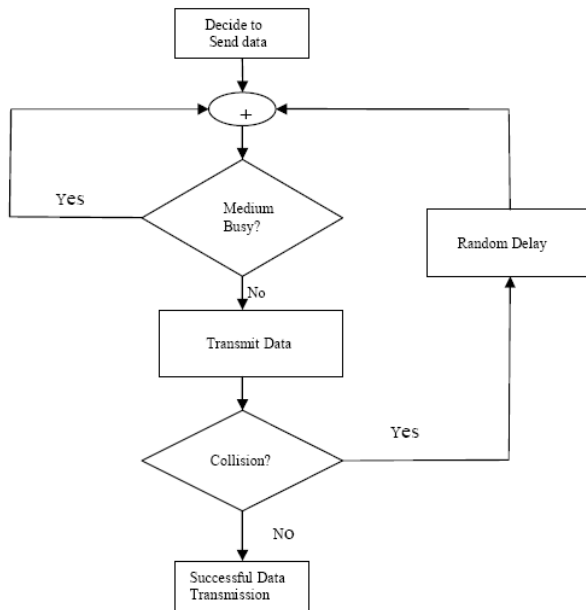

Figure 2-5: Steps in a CSMA/CA transmission

2.5.2 CSMA/CA: RTS and CTS

The hidden terminal problem can be a great cause of collision in a wireless network, consider Figure 1.4 where node 'A' and 'B' are able to associate with the AP but due to the faded signal they are not able to hear transmission from each other. If one node sends data and half way through the transmission, the second one has data so send, it will wait for the DIFS period, sense the idle channel and transmit its data causing a collision.

In order to avoid such a scenario, CSMA/CA permits the use of Request to Send (RTS) and Clear to Send (CTS) control frames. A station that wishes to transmit data broadcast a RTS frame which is received by all station and the AP. The AP responds by sending a CTS frame which is received by all station confirming that the channel has been reserved for the station to send data. During this time all other stations refrain from sending any data. This effectively avoids expensive data frame collisions. This is illustrated in the figure 1.6 below.

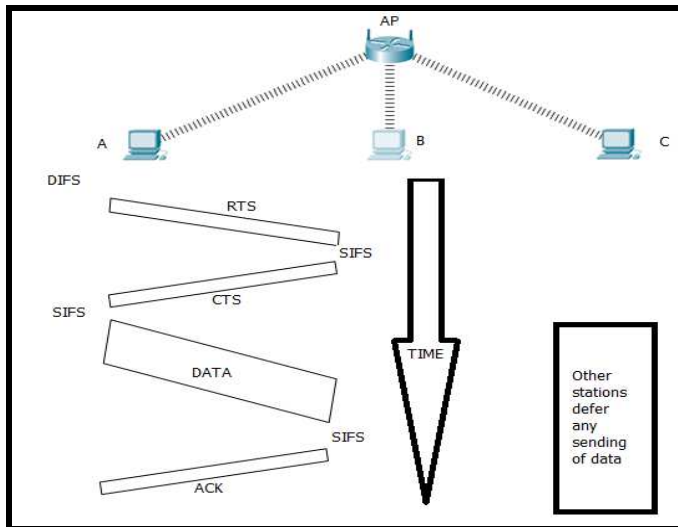

Figure 2-6: Use of RTS and CTS in minimizing hidden node problem

Due to the requirements for more resources and the delays introduced the RTS/CTS exchange mechanism, it is only used for transmission of long data frames. For the normal sized data frames the RTS/CTS process is usually used (Kurose et al., 2007).

2.5.3 IEEE 802.11 Frame Format

The IEEE 802.11 frame format is very similar to the IEEE 802.3 Ethernet standard with fields such as CRC, address, payload maintaining the same functions. Figure 1.8 outlines the field of an IEEE 802.11 frame. The Type field is used to distinguish whether a frame RTS, CTS, ACK or data. Duration to reserved transmission time require to send both data and the ACK when using RTS/CTS. WEP is used to indicate whether encryption is being used or not. Sequence Number allows a station to distinguish between a new frame and a retransmitted frame, this can occur when ACKs get lost and the sender has to retransmit the frame. All fragments of the same packet have the same sequence number but are individually identified using the four-bit Fragment number. The Cyclic Redundancy Check (CRC) used by the receiver to detect bit errors. Address-1 is MAC address of wireless host or AP to receive this frame. Address 2: MAC address of wireless host or AP transmitting this frame. Address 3: MAC address of router interface to which AP is attached. Address 4: used only in ad hoc mode.

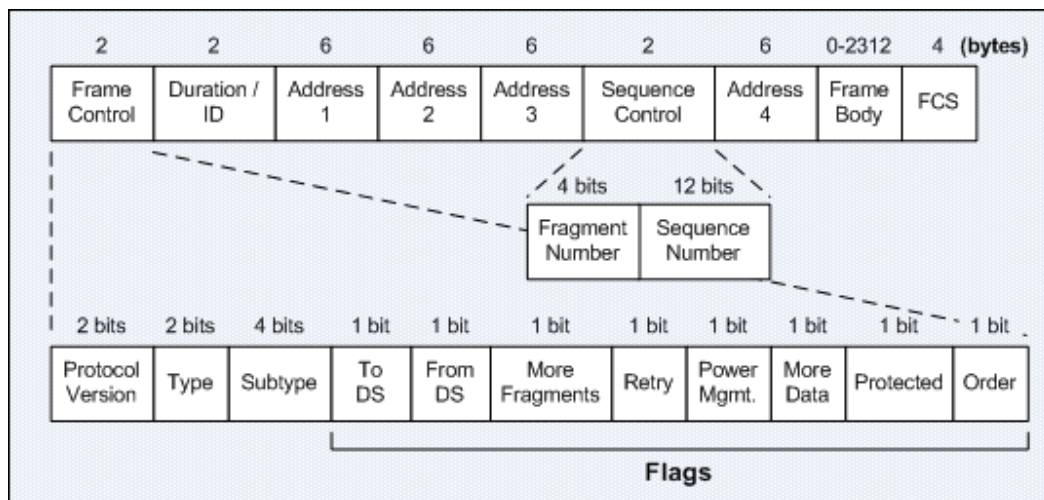

Figure 2-7: IEEE 802.11 Frame Format

2.6 QUALITY OF SERVICE (QoS)

QoS generally refers to the quality as perceived by the user/application while in the networking community, QoS is accepted as a measure of the service quality that the network offers to the applications/users. Prasad and Prasad (2005) have defined QoS as the provision of consistent, predictable data delivery services that satisfy the customer application requirements. Real-time traffic over IP has strict requirements for achievement of toll quality services matching the traditional Public Switched Telephone Network (PSTN).

Provision of end-to-end quality of service requires the use of several protocols including QoS over WLAN (IEEE 802.11e) which is the main focus of this research, signaling protocols like Session Initiation Protocol (SIP), routing protocol like Open shortest Path First (OSPF), communication protocols between IP and PSTN, Real Time Transport Protocol (RTP), Differentiated services (DiffServ), Resource Reservation Protocol (RSVP) and many others.

2.6.1 Quality of Service Models

Ranjba (2007) discusses three QoS models as follows: Best Effort, Integrated Services (IntServ) and Differentiated Services (DiffServ) models.

(a) Best-Effort Model

The best-effort model means that no QoS policy is implemented and provide no differentiation of traffic, packets belonging to voice calls, e-mails, file transfers, and so on are treated the same. The key benefits of the best effort model is scalability, this is what has made the Internet grow without limitations. This model is also easy and quick

to implement as it requires no special QoS configurations. The model however has its limitations as lacks service guarantee on packet loss, available bandwidth and delay.

The original 802.11 wireless networks were basically providing best effort quality of services meaning that no differentiation of services was done and all traffic including interactive voice was treated in a similar manner.

(b) Integrated Services Model

The Integrated Services (IntServ) model provides end-to-end QoS which was demanded by real-time applications signaling and managing/reserving network resources for the applications that need it and demand it. IntServ is often referred to as Hard-QoS, because Hard-QoS guarantees characteristics such as bandwidth, delay, and packet loss, thereby providing a predictable service level. Resource Reservation Protocol (RSVP) is the signaling protocol that IntServ uses. An application that has a specific bandwidth requirement must wait for RSVP to run along the path from source to destination, hop by hop, and request bandwidth reservation for the application flow. If the RSVP attempt to reserve bandwidth along the path succeeds, the application can begin operating otherwise the application cannot begin operating. This is similar to the PSTN which guarantees required resources through end-to-end signaling. RSVP is used in signaling as well as in call admission control (CAC).

(c) Differentiated Services Model

Differentiated Services (DiffServ) is referred to as the Soft-QoS as it does not use end-to-end signaling like the IntServ. In the DiffServ model, traffic is first classified and marked. DiffServ provides QoS on per-hop behavior (PHB) through pre-configuration of the QoS parameters on the routing and switching devices. Traffic received by the routing is accorded QoS treatment depending on its marking based on the preconfigured QoS policy. DiffServ can protect the network from oversubscription by using policing and admission control techniques as well. For example, in a typical DiffServ network, voice traffic is assigned to a priority queue that has reserved bandwidth (through LLQ) on each node. To prohibit too many voice calls from becoming active concurrently, CAC can be deployed. This model is more scalable because signaling and status monitoring are not required.

The key advantage of DiffServ is scalability and differentiation of network traffic based on business requirements, but this model suffers from lack of provision of guaranteed service level and it requires coordinated configurations of several complex mechanisms on all element of the network through which traffic flows in order to provide the desired results.

2.6.2 Real-time Traffic Requirements

In their work on WLANs and QoS, Prasad and Prasad (2007) identified the three factors that profoundly affect the provision of quality of service as follows:

- (a) Delay: This refers to the time that a packet takes to move from the source to the destination. The same authors further pointed out that delay becomes significant if one way delay becomes greater than 250 milliseconds making end-to-end delay become the major constraint in packet network.
- (b) Jitter: This is the variability in delays on arrival (at the destination) of packets. Removal of jitter requires that packets be buffered at the destination long enough to permit the slowest packets to arrive so that they are played in sequence and at a constant delay.
- (c) Packet loss can be caused by limited network resources like lack of bandwidth, exhausted memory buffers and processing resources on networking equipment and errors on transmission link. Wireless network and IP networks do not provide guarantee that packet will be delivered at all.

The above three parameters can be used to objectively measure quality of service for real-time traffic. Subjective QoS measurement can be achieved through the mean opinion score (MOS) which is an average rating of given several users listening to the same voice sample (Niemegeers et al., 2003).

2.6.3 Challenges on Provision of QoS over WLANs

Wireless network segments need to provide toll quality standard to the real time traffic in order to maintain an end-to-end high quality call that everyone expects from telephone network. To achieve this level of expectation, the following areas must be addressed:

- (a) WLANs and the underlying IP network must provide acceptable quality and consistent services for the high priority real-time traffic like voice and the accompanying signaling traffic comparable to what the traditional PSTN networks have been offering.
- (b) The WLAN networks must strike a balance between provision of quality service to prioritized traffic for instance interactive voice and fair transmission of the rest of the traffic in a converged network environment comprising voice, video and data traffic.

2.6.4 IEEE 802.11 and the Need for QoS

The application of WLAN has continued to gain acceptance as a key access technology due to several improvement including the ease of use, availability and fair pricing of the WLAN systems, improved speed currently exceeding 200Mbps on the 802.11n standard and the improved security controls using the IEEE802.11i standard, this confirms research work by Iqbal (2002) on the future of WLANs that they will replace or continue to add functionality to the wired networks.

Today WLANs implementation are found in almost every corporate networks, homes, colleges and universities and even in public places providing hot spots for Internet access. With the current trend in the development of WLANs expected to continue, there emerges a need to address differentiation of traffic types to satisfy the requirements for real time traffic such as interactive voice and video that are delay sensitive.

Service differentiation means that different traffic types receive varying treatments as they cross the network with the delay sensitive traffic receiving priority transmission and the less priority traffic receiving normal treatment. For a network to offer meaningful real time application service, there are minimum QoS parameters that must be met, such as throughput, delay, jitter and packet loss, which describes quality of data traffic over a network. IEEE 802.11 does not offer a solution to service differentiation and regardless of the QoS requirements of the traffic, which vary from application to application, all traffic types receive the same treatments.

Ohrman (2004) argues that provision of QoS on WLAN has several challenges compared to wired networks, for instance in WLANs, the packet error rate can be in the range of 10-20%, bit rate (accessible speed) depends on the RF channel condition which can be affected by many factor including weather conditions. It is therefore paramount that if WLANs were to provide toll quality voice, they have to support QoS for interactive traffic. Ranjba (2007) has recommended the following parameters for provision of quality service: end-to-end delay should be about 150 ms, packet loss of about 1% and jitter of about 30 ms, this is in agreement with Ohrman's (2004) work that latency should not be in excess of 50 milliseconds for WLAN to bypass or replace PSTN.

The original 802.11 MAC includes two modes operations or the access modes, the media contention based DCF and the centralized PCF based on polling client on need to transmit. The 802.11e which uses HCF is designed to improve QoS in WLANs. It introduces two new operation modes, Enhanced DCF (EDCF) and the HCF Controlled channel Access (HCCA). The HCF is designed to work with all possible 802.11 physical layer technologies.

2.6.5 Legacy IEEE 802.11 MAC

To understand the improved 802.11e QoS based standard, this research started by looking at the legacy 802.11 standard that lacked the QoS mechanisms, it is against that background that the QoS features was investigated for any QoS performance related improvements and also any limitation of the standard.

As stated earlier, 802.11 MAC can use the two access modes (DCF and PCF) shown in the Figure 2.1 below.

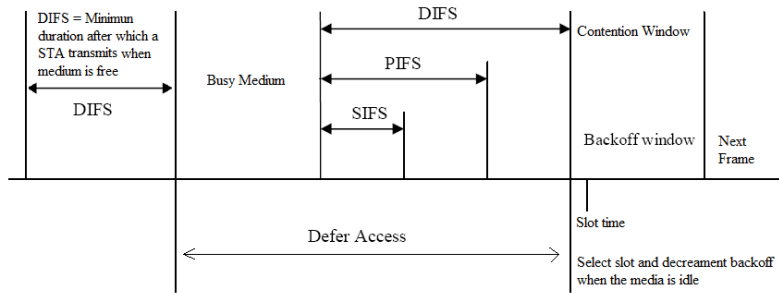

Figure 2.8: Use of DIFS, SIFS and the Backoff Timers

Currently most of the implementation is based on DCF due to the fact that, PCF, although it provides some level of guaranteed transmission, previous research work shows that it does not improve on QoS provision (Lindgren et al., 2001). DCF access mode can therefore be considered to be the exclusively used access mechanism. The challenge suffered by WLANs in the use of DCF is the contention for the media by all STAs including the ones with delay sensitive traffic. Since the mechanism is contention based, all STAs with data to send have to contend for the medium when it becomes idle through an exponential backoff based scheme, this results in further decreased network performance as the number of nodes increase.

Current research work on comparative QoS performance of 802.11 (DCF) and 802.11e (EDCF) by Abbas et al. (2010) indicates clearly that the latter gives better results and is a more dependable mechanism for the provision of differentiated services across several traffic types demanding different treatments. IEEE 802.11e defines new distributed access mechanism called EDCA (Enhanced Distributed Channel Access), which is basically the improved version of DCF in the original standard. It supports Quality of Service by introducing service differentiation. Different types of traffic are assigned with different priorities based on their QoS requirements, and service differentiation is introduced by using a different set of medium access parameters for each priority.

2.6.6 Distributed Coordinated Function (DCF)

DCF is a contention based mechanism that supports fairness in transmission of traffic in a WLAN networks without considering the delay sensitive applications using packetized voice and video. After every transmission of a packet, each station must contend for the media introducing fairness over the use of the media. DCF has no mechanism to guarantee minimum QoS metrics required by an application. One option of providing QoS is to designate cell with few wireless nodes that can be used real-time application (Prasad et al., 2004), this option though is not scalable in today's environment where network services are all converged.

DCF mechanism is has been in use on 802.11 networks and proved to be highly effective and also scales well with growing number of uses, DCF does not define the maximum number per channel. DCF is again not limited by

additional APs since they result to using different and also access point frequency channels. For instance in the 2.4 GHz band APs can auto-detect and use the three non-overlapping channels of 1, 6 and 11. It's however worth noting that as the system accepts more stations, delays will be introduced when users have data to transmit at the same time thus negatively affecting the quality of service.

2.6.7 Point Coordinated Function (PCF)

PCF is an optional feature in the IEEE 802.11 standard only usable on infrastructure network configurations although most vendors do not implement it, however PCF has no compatibility issues with the standard. This access method uses a Point Coordinator (PC), which operates at the AP of the BSS, to determine which STA currently has the right to transmit. The operation is essentially that of polling, with the PC performing the role of the polling master. The operation of the PCF may require additional coordination, not specified in this standard, to permit efficient operation in cases where multiple point-coordinated BSSs are operating on the same channel, in overlapping physical space.

The PCF uses a virtual carrier sense (CS) mechanism aided by an access priority mechanism. The PCF shall distribute information within Beacon management frames to gain control of the medium by setting the NAV in STAs. In addition, all frame transmissions under the PCF may use an inter-frame space (IFS) that is smaller than the IFS for frames transmitted via the DCF. The use of a smaller IFS implies that point-coordinated traffic shall have priority access to the medium over STAs in overlapping BSSs operating under the DCF access method. The access priority provided by a PCF may be utilized to create a Contention Free (CF) access method. The PC controls the frame transmissions of the STAs so as to eliminate contention for a limited period of time (IEEE, 2007).

In the PCF mode, the AP is the coordinator in the media access process, it sends beacon frames at regular intervals of usually a 100 milliseconds. Between these beacon frames, PCF defines two periods: the Contention Free Period (CFP) and the Contention Period (CP). In the CP, DCF is used. In the CFP, the AP sends Contention-Free-Poll (CF-Poll) packets to each associated station, one at a time, to give them the right to send a packet. Although this allows for a better management of QoS, PCF does not define classes of traffic as is common with other QoS systems as seen in QoS models like DiffServ and therefore does not provide the desired traffic differentiation. Delay sensitive packet will still suffer degraded services as the PC takes turns to serve less sensitive traffic.

2.7 IEEE 802.11E QOS SUPPORT MECHANISMS

The legacy 802.11 does not have any QoS features and as noted earlier, uses the best effort model where all data flows are treated equally in both Distributed Coordinated Function (DCF) and the Point Coordinated Function (PCF). This means that there is no special treatment given to traffic on channel for services with critical requirements.

The 802.11e enhances the DCF and the PCF, through a new coordination function known as the hybrid coordination function (HCF). Within the HCF, there are two methods of channel access, similar to those defined in the legacy 802.11 MAC: HCF Controlled Channel Access (HCCA) and Enhanced Distributed Channel Access (EDCA). Figure 2.2 shows the two HCF access methods. For the contention-based channel access method, EDCA mechanism is used while HCCA mechanism is used for contention-free transfer. Both EDCA and HCCA define Traffic Categories (TC), through the use of varying times higher priority traffic in the respective TCs is transmitted ahead of the other traffic categories. EDCF is called Enhanced Distributed Channel Access (EDCA).

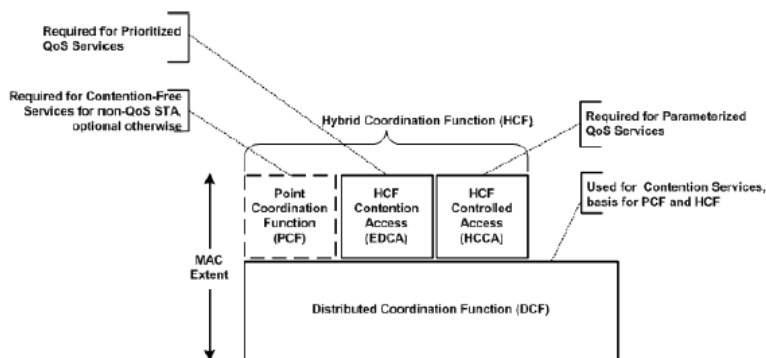

Figure 2-9 HCF access methods.

This enhanced standard does not suggest any functional changes at physical layer but does have significant changes at Medium Access Control (MAC) layer to enable QoS (Abbas et al., 2010). Figure 2.10 shows the mapping of the 802.11 and 802.11e on the OSI reference model with the PHY mode (Physical Layer mode, coding and modulation scheme) remaining intact.

7	Application		} Normal process of Encapsulation/Decapsulation
6	Presentation		
5	Session		
4	Transport		
3	Network		
2	LLC sub-layer		
	PCF	HCCA	
1	DCF	EDCA	
1	802.11, 802.11a, 802.11b, 802.11g, 802.11n		} PHY is defined at layer 1 of OSI and is independent of the MAC method used.

Figure 2-10: Mapping of 802.11 and 802.11e MAC on the OSI reference model.

The HCF is implemented in all QoS STAs. STAs may obtain TXOPs using one or both of the channel access methods i.e. contention or contention-free based. If a TXOP is obtained using the contention-based channel access, it is defined as EDCA TXOP. If a TXOP is obtained using the controlled channel access, it is defined as HCCA

TXOP. If an HCCA TXOP is obtained due to a QoS (+) CF-Poll frame from the HC, the TXOP is defined as a polled TXOP.

2.7.1 HCF Controlled Channel Access (HCCA)

The HCCA mechanism uses a QoS-aware centralized coordinator known as the Hybrid Coordinator (HC), the HC is usually implemented as part of the QoS Access Point (QAP) which forms a QoS Basic Service Set (QBSS). Since HC has a higher medium access priority than non-AP STAs it is able to manage access by allocating TXOPs to itself and to other STAs so as to provide limited-duration controlled access phase (CAP) for contention-free transmission of data. The HC is a type of centralized coordinator, but differs from the PC used in PCF in that it may exchange HCF frame in a BSS during both the CP and the CFP. Another significant difference is that the HC grants a non-AP STA a polled TXOP with duration specified in a QoS (+) CF-Poll frame. During a given TXOP an STA may transmit multiple frame exchange provided that the TXOP period is not exceeded.

All STAs inherently obey the NAV rules of the HCF because each frame transmitted under HCF by the HC or by a non-AP STA contains a duration value chosen to cause STAs in the BSS to set their NAVs to protect the expected subsequent frames. The HC performs delivery of buffered broadcast and multicast frames following DTIM Beacon frames. The HC may also operate as a PC, providing (non-QoS) CF-Polls to associated CF-Pollable STAs.

The HC gains control of the WM as needed to send QoS traffic to non-AP STAs and to issue QoS (+)CF-Poll frames to non-AP STAs by waiting a shorter time between transmissions than the STAs using the EDCA procedures. The duration values used in QoS frame exchange sequences reserve the medium to permit completion of the current sequence. The HC may include a CF Parameter Set element in the Beacon frames it generates. This causes the BSS to appear to be a point-coordinated BSS to STAs.

2.7.2 Enhanced Distributed Coordinated Function (EDCF)

The IEEE 802.11e EDCA contention-based media access mechanism was proposed for enhancing the traditional 802.11 DCF MAC protocols with QoS facility (Abu-Tair, M., Geyong M, 2006), it provides differentiated, distributed access to the wireless media for STAs using eight different Access Categories (AC) also known as user priorities. The EDCA mechanism defines four access categories (ACs) that provide support for the delivery of traffic with UPs at the STAs. The AC is derived from the UPs as shown in Table 2.1.

Priority	UP (Same as 802.1D user priority)	802.1D designation	AC	Designation (informative)
Lowest ↓ Highest	1	BK	AC_BK	Background
	2	—	AC_BK	Background
	0	BE	AC_BE	Best Effort
	3	EE	AC_BE	Best Effort
	4	CL	AC_VI	Video
	5	VI	AC_VI	Video
	6	VO	AC_VO	Voice
	7	NC	AC_VO	Voice

Table 2-1 Mapping of UP to AC with the designation of the traffic types.

For each AC, an enhanced variant of the DCF, called an Enhanced Distributed Channel Access Function (EDCAF), contends for TXOPs using a set of EDCA parameters from the EDCA Parameter Set element or from the default values for the parameters when no EDCA Parameter Set element is received from the AP of the BSS with which the STA is associated.

Figure 2-11 illustrates a mapping from frame type to UP to the four Access Categories (AC), each of the AC having four independent EDCAFs, one for each queue.

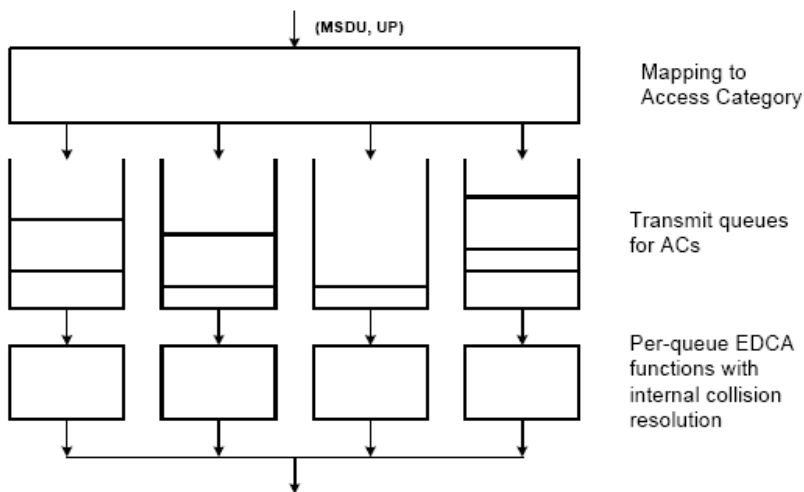

Figure 2-11 Reference implementation model

2.8 EDCA QOS PARAMETERS

The current IEEE 802.11e specifies EDCF as the contention-based QoS mechanism containing several enhancement of the DCF discussed earlier. These enhancements relate to the following parameters that are used to provide differentiated services to the four access categories.

- (i) Arbitration Inter-Frame Space (AIFS)
- (ii) Minimum contention window (CW_{min})
- (iii) Maximum contention window CW_{max}
- (iv) Transmission Opportunity (TXOP) limit

2.8.1 Arbitration Inter-Frame Space (AIFS)

The Arbitration Inter-Frame Spacing (AIFS) specifies a wait time for data frames which is measured in slots with default values being 2, 2, 3, 7 for the Voice, Video, Best Effort and Background access categories respectively. Arbitration Inter-Frame Spacing (AIFS) therefore defines different inter-frame gaps for traffic from each of the 4 Access categories. This replaces the original DCF Inter-Frame Spacing (DIFS) which defined only a single inter-frame gap value for all data frames. Using AIFS, each frame awaiting transmission must wait until the medium is declared to be available through Clear Channel Assessment (CCA) and the Network Allocation Vector (NAV). Once the medium is available, each logical station (one for each priority queue) must wait the defined inter-frame space time based on the queue to which the traffic is assigned.

Each of the 4 priority queues has a defined inter-frame space value corresponding to the priority assigned to the queue. For example, the Voice queue is the highest priority and as such has the lowest inter-frame space timer. The AIFS timers assigned by IEEE 802.11e are all defined as 1 Short Inter-Frame Spacing (SIFS) value plus a variable number of slots times (AIFSN) which are defined by the physical layer encoding method in-use (CCK, DSSS, OFDM).

The AIFS Number (AIFSN) values are administrator configurable, with default values defined as the following:

Voice Queue	1 SIFS + 2 * slot time (AIFSN = 2)
Video Queue	1 SIFS + 2 * slot time (AIFSN = 2)
Best Effort Queue	1 SIFS + 3 * slot time (AIFSN = 3)
Background Queue	1 SIFS + 7 * slot time (AIFSN = 7)

Considering the above parameters, the table 2-2 shows the default AIFS values for each PHY implementation.

AC	AIFSN	802.11b AIFS[AC]	802.11g AIFS[AC]	802.11a AIFS[AC]	802.11n 2.4GHz AIFS[AC]	802.11n 5GHz AIFS[AC]
SIFS Time	---	10µs	10µs	16µs	10µs	16µs
Slot Time	---	20µs	Long = 20µs Short = 9µs	9µs	Long = 20µs Short = 9µs	9µs
AC_VO	2	50µs	Long = 50µs Short = 28µs	34µs	Long = 50µs Short = 28µs	34µs
AC_VI	2	50µs	Long = 50µs Short = 28µs	34µs	Long = 50µs Short = 28µs	34µs
AC_BE	3	70µs	Long = 70µs Short = 37µs	43µs	Long = 70µs Short = 37µs	43µs
AC_BK	7	150µs	Long = 150µs Short = 73µs	79µs	Long = 150µs Short = 73µs	79µs

Table 2-2 : Default AIFS values for each PHY implementation

2.8.2 Minimum Contention Window (CW_{min}) & Maximum Contention Window (CW_{max})

This parameter is used by the QoS algorithm to determine the initial random wait time for data transmission during a period of contention for Access Point resources. The value specified here in the Maximum Contention Window is the upper limit from which the initial random backoff wait time will be determined.

Once the appropriate AIFS time has been waited, each station begins decrementing the random backoff timer by one for every slot time that passes. If another station begins transmitting before its timer has reached zero, the station defers access until the medium is available again, at which time it continues decrementing the timer from where it previously left off. Once the timer reaches zero, the station is allowed to transmit the frame over the air.

If a collision occurs where two stations transmit at the same time, no acknowledgment of the frame will be received and the station will increment its retry counter and increase its contention window according to the binary exponential backoff algorithm, up to a maximum contention window size of CW_{max}. The stations must then wait the appropriate AIFS time, select a new random backoff timer using the new contention window range, and proceed as before.

Similar to AIFS, the differences in the contention window values serve to prioritize traffic in higher priority queues by allowing them to wait shorter time intervals before being allowed to transmit over the air. The CW_{min} and CW_{max} values vary based on the PHY and the AC queue in use.

Notice how the contention window range is the same across all OFDM PHYs, with legacy CCK PHY being the only dissimilar value. Traffic prioritization is therefore very coarse, and is based not on application traffic but on the PHY used for transmission. Effectively, all frames in a legacy DCF Basic Service Set (BSS) have the same priority and access to the medium. This can lead to problems, especially for latency sensitive applications such as voice and videoconferencing.

EDCA contention window values vary based on the Access Category (AC) and are derived from the DCF base values shown above. These values are administrator configurable, with default values defined as:

AC_VO (Voice)	$CW_{min} = (aCW_{min}+1)/4 - 1$	$CW_{max} = (aCW_{min}+1)/2 - 1$
AC_VI (Video)	$CW_{min} = (aCW_{min}+1)/2 - 1$	$CW_{max} = aCW_{min}$
AC_BE (Best Effort)	$CW_{min} = aCW_{min}$	$CW_{max} = aCW_{max}$
AC_BK (Background)	$CW_{min} = aCW_{min}$	$CW_{max} = aCW_{max}$

The default EDCA contention window values for the 802.11b PHY in a QoS BSS are defined as:

Voice Queue	$CW_{min} = 7$	$CW_{max} = 15$
Video Queue	$CW_{min} = 15$	$CW_{max} = 31$
Best Effort Queue	$CW_{min} = 31$	$CW_{max} = 1023$
Background Queue	$CW_{min} = 31$	$CW_{max} = 1023$

The default EDCA contention window values for the 802.11g/a/n PHY in a QoS BSS are defined as:

Voice Queue	$CW_{min} = 3$	$CW_{max} = 7$
Video Queue	$CW_{min} = 7$	$CW_{max} = 15$
Best Effort Queue	$CW_{min} = 15$	$CW_{max} = 1023$
Background Queue	$CW_{min} = 15$	$CW_{max} = 1023$

Notice the differences from legacy DCF contention window ranges. In a QoS BSS, each queue clearly has differentiated access to the medium. For instance frames in the voice queue will initially select a random backoff timer between 0 - 3, versus frames in the video queue which will initially select values between 0 - 7. In this manner, frames in the voice queue have a statistically greater chance of selecting a random timer value that is lower than frames in the video, best effort, and background queues. It is still possible that a frame from a lower priority queue will select a lower random backoff timer, but most of the time they will not.

The maximum contention window range for voice and video are still relatively small compared to the other queues. On a heavily utilized network, as retransmission attempts increase, the statistical advantage for voice and video frames gets even better.

The CW_{min} and CW_{max} values are encoded in exponent form, base 2, then decremented by 1 in the EDCA Parameter Set information element, and each field is 4 bits long. Therefore, the minimum contention window values is 0 and the maximum value is 32,767. However, in practice the typical maximum value is never set above 1,023.

2.8.3 Transmission Opportunity (TXOP) limit

Transmission Opportunity (TXOP) is an interval of time when a particular quality of service (QoS) station (STA) has the right to initiate frame exchange sequences onto the wireless medium (WM). A TXOP is defined by a starting time and a maximum duration in milliseconds. The TXOP is either obtained by the STA by successfully

contending for the channel or assigned by the hybrid coordinator (HC). In other words, a station can transmit multiple data packets consecutively until the duration of transmission exceeds the specific TXOP limit. The TXOP provides not only service differentiation among various ACs, but also improves the network performance.

Considering that all stations use the same TXOP limit in the IEEE 802.11e EDCA, If traffic quantity of each station is same, bandwidth is allocated equally. If each station supports multimedia application service with different traffic generation rate, fairness problem occurs. As traffic generation rate is different, each station has mutually different traffic quantity. If all stations use the same TXOP limit value in this situation, a station with less multimedia traffic quantity can promptly transmit data packets in its queue. Thus, the station acquires good performance by satisfying its delay bound (Nam et al., 2012).

However, if the high-priority STAs are allocated high TXOPs, the low priority senders will resultantly suffer from increased delay. With aggressive usage of the shared bandwidth, this can ultimately bring about starvation for the low-priority traffic.

2.8.4 Relationship between AIFSN, CWmin/CWmax

The Figure 2.12 graphically illustrates the relationship between AIFSN, CWmin/CWmax and its affect on QoS. In essence a voice client waits less time before trying to retransmit than a lower access category and will therefore have a better chance at sending data, it is not a strict priority system.

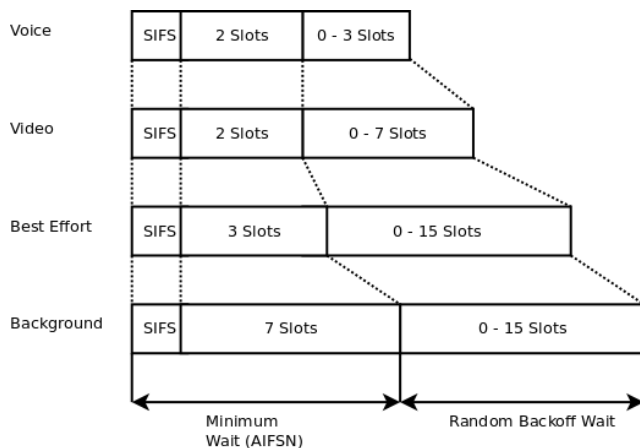

Figure 2.12: The relationship between AIFSN, CWmin and CWmax

2.8.5 Related Work

Substantial work has been done on the 802.11 QoS: Deng (1999) propose a scheme that uses two properties of IEEE 802.11 to provide differentiation: the interframe space (IFS) used between data frames, and the backoff mechanism. If two stations use different IFS, a station with shorter IFS will get higher priority than a station with a longer IFS.

Since the IEEE 802.11 standard already defines two kinds of IFS (PIFS and DIFS) to assure that no low priority traffic is sent during the contention free period of PCF, these can be used for easy implementation of the Deng scheme. By using these two different interframe spaces, traffic can be differentiated and classified into two classes. To further extend the number of available classes, the backoff mechanism could be used to differentiate between stations. This is done by designing the backoff algorithm such that it generates backoff intervals in different intervals, depending on the priority of the station.

K. Sharma (2011) evaluated performance of 802.11 WLANs scenarios using OPNET modeler . Throughput of WLANs was evaluated in presence of high priority traffic generating data simultaneously . It was observed that though the number of nodes generating low priority traffic is higher , the data flow of these services was quite as compared to high priority traffic with fewer number of supporting nodes. This prioritization is achieved at the cost of degradation in the best effort services which could be contributing to business traffic coming from various users. It was also observed that throughput of WLANs becomes almost constant after sometime which in turn affects the network performance.

Bianchi (2011) made an analysis of the prioritization function of the EDCA and DCF by varying the contention window and AIFS parameters against QoS metrics such as throughput, delay and also detailed level metric like per slot occupancy probability and he concluded that AIFS differentiation provides better performance than contention window differentiation.

Sobrinho and Krishnakumar (1999) did some work on provision of QoS for the WLANs and came up with a scheme known as Blackburst whose main goal was to minimize the delay for real time traffic which was imposing certain requirements on the traffic to be prioritized. Blackburst required that all high priority stations try to access the medium with constant intervals, this interval was supposed to be the same for all high priority stations. Further, Blackburst also requires the ability to jam the wireless medium for a period of time. This scheme like most QoS schemes focused on the high priority traffic.

Manzoor (2008) in his research work studied various enhancements made in IEEE 802.11e and evaluated the performance of IEEE 802.11e EDCA by comparing it with the IEEE 802.11 DCF in order to support multimedia traffic. He noted that the IEEE 802.11e MAC utilizes a channel access function, called Hybrid Coordination Function, which includes both a contention-based channel access and a centrally-controlled channel access mechanisms. The contention-based channel access also called Enhanced Distributed Coordination Access (EDCA) and is a priority scheme. The goal of his thesis was to evaluate the performance of high priority traffic over these networks. He used simulations to compare EDCA and DCF mechanisms in GloMoSim.

CHAPTER 3 METHODOLOGY

3.1 RESEARCH DESIGN AND ITS JUSTIFICATION

This research employed experimental research methods to elicit raw data from the subjects of the target systems investigated by setting up network topologies on simulation models. To ensure that the results are dependable, only simulation models that have been tested were used. Network simulators try to model the real world networks. The principal idea is that if a system can be modeled, then features of the model can be changed and the corresponding results can be analyzed. As the process of model modification is relatively cheap than the complete real implementation, a wide variety of scenarios can be analyzed at low cost (relative to making changes to a real network).

3.2 MAC PROTOCOL QoS PARAMETERS AND THE PERFORMANCE METRICS

The research work investigated the correlation between the QoS parameters supported by IEEE802.11e MAC protocol and the metrics that are used to measure QoS as shown in table 3-1.

IEEE802.11e QoS Parameters	Performance Measurement Metrics
Arbitration Inter-Frame spacing (AIFS) number	1. Packet loss
Minimum Contention Window (CW _{min}) size	2. Load
Maximum Contention Window (CW _{max}) size	3. Delay
Transmission opportunity (TXOP)	4. Throughput

Table 3-1: IEEE802.11e QoS Features and the QoS parameters

3.2 SOURCES OF DATA/INFORMATION AND RELEVANCE OF DATA TO THE PROBLEM

Real-time and non-real-time traffic types were generated by wireless stations (STAs) and propagated across the WLAN. This enabled the researcher to analyze the effectiveness of the QoS features provided by the 802.11e standard for the real-time (voice) traffic and at the same time investigate whether the data traffic gets fair treatment for the shared resources and does not experience 'starvation'.

3.3 TOOLS, PROCEDURES AND METHODS FOR DATA COLLECTION AND THEIR JUSTIFICATION

A comparative analysis on network simulators (Pan, 2008) isolates OPNET as one of the most famous and popular network simulators owing to its long presence in the industry and its maturity level in terms of available features. OPNET Simulator provides high-fidelity modeling, simulation, and analysis of wireless networks, including the RF environment, interference, transmitter/receiver characteristics, and full protocol stack (including MAC, routing, higher layer protocols, and applications). Furthermore, the ability to incorporate node mobility and interconnection with wire-line transport networks provide a rich and realistic modeling environment.

Some of the major features of the 802.11 wireless LAN (WLAN) model include: Support for 802.11a, b, e, g, n; DCF/PCF MAC algorithms; HCF EDCA mechanisms with TXOP frame bursting; Support for QoS facility of 802.11e; Optional block-acknowledgement and no-acknowledgement operations of 802.11e; Reliable data transmission via RTS-CTS exchange; Fragmentation (threshold-based); Interoperability among non-11e and 11e capable nodes; PHY layer support: FHSS, IR, DSSS, OFDM, PHY features; Short guard intervals and reduced inter-frame spacing (RIFS) for 11n wireless LAN devices; Abstracted MIMO capability for 11n wireless LAN devices for higher data rates; Auto-assignment of channels to BSSs (optional) and Roaming (OPNET, 2012).

OPNET comes with a Graphic User Interface (GUI) which assists in designing and simulating the network by using network components and easily compares certain networks by multiple scenarios OPNET provides. The interface scan can be used to generate graphs and spreadsheet which allow a designer to analyze the network easily after completing a simulation. Through OPNET simulation, this research was performed as follows:

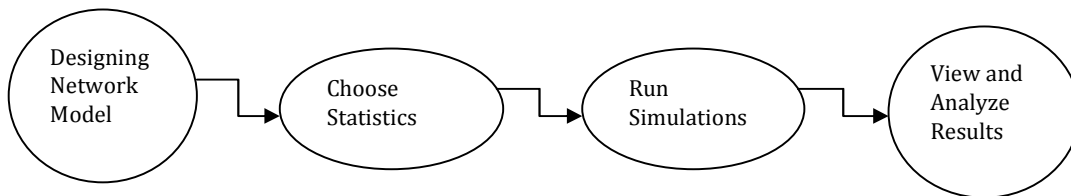

(i) Designing network model

The basic necessities for designing the network are what types of topologies and what types of devices will be used in the network designing. OPNET provides the all kinds of topologies, devices and cables at menu, Rapid Configuration and Object Palette.

(ii) Setting statistics

After modeling the network, the statistic factors that a researcher wants to record in the simulation need to be set. There are three types of statistics in OPNET: Global Statistics, Node Statistics and Link Statistic. These statistic factors enable a researcher to gather the data at every node, link and global statistics. The criteria units in this paper are Traffic Received (packets/sec) and Traffic Sent (packets/sec) in Global Statistics.

(ii) Simulations conducted

After designing the network and setting the statistics, the network simulations were performed. OPNET stores data by the selected statistics.

(v) View and analyze results

After running the simulation, all data are seen through 'View Result' which includes the data of all scenarios. View Result enables a researcher to analyze and compare data between different scenarios.

3.4 DATA ANALYSIS METHODS AND THEIR JUSTIFICATION

The QoS parameters for the real-time traffic include delay, packet loss and jitter. This research therefore measured the performance of real-time traffic against these parameters in a converged environment. This was achieved as follows:

- i. First the performance of real-time traffic against a gradual increase of real-time traffic flows was observed to verify the effectiveness of the default settings of the 802.11e mechanism. The concept of QoS without admission control mechanism was also observed.
- ii. The corresponding performance of the non-real-time flows with a steady increase in real-time traffic flows was observed to verify whether the default settings of the 802.11e has a protection mechanism against 'starvation' for the less priority traffic.
- iii. Final tests involved the observation of the above two scenarios on varying 802.11e QoS features ie Backoff time, Inter Frame Spacing and Contention Window size.

3.5 LIMITATIONS OF METHODOLOGY AND HOW THEY COULD HAVE BEEN OVERCOME

Network simulators are not perfect. They cannot perfectly model all the details of the networks. However, if well modeled, they will be close enough so as to give the researcher a meaningful insight into the network under test, and how changes will affect its operation. To overcome the limitation of the simulated test environment, it is noted that voice and data traffic from the real end user devices like IP phones and computers should have been incorporated in the network.

CHAPTER 4: DESIGN

4.1 WIRELESS NETWORK TOPOLOGY

The simulation comprised a topology of twenty wireless nodes and one access point (AP), this setup simulates a basic service set wireless network. Out of the twenty wireless nodes, ten were used for the generation of real time traffic while the rest were be used for the generation of less priority traffic. The wireless nodes generates traffic that is sent to the other nodes via the access point for testing purpose. Figure 4.1 shows an illustration of the simulated wireless network topology.

The wireless workstation node model represents a workstation with client-server applications running over TCP/IP and UDP/IP. These workstations are capable of supporting protocols such as UDP, TCP, IP, IEEE802.11, RIP and OSPF. The workstation supports one underlying WLAN connection at 1 Mbps, 2Mbps, 5.5 Mbps, and 11 Mbps.

The workstation requires a fixed amount of time to route each packet, as determined by the "IP Forwarding Rate" attribute of the node. Packets are routed on a first-come-first-serve basis and may encounter queuing at the lower protocol layers, depending on the transmission rates of the corresponding output interfaces.

To allow for the specification of application traffic generation in the node Client Custom Application, Client Database Application, Client Email, Client Ftp, Client Remote Login, Client X Windows, Client Video Conferencing, Client Start Time attributes were configured.

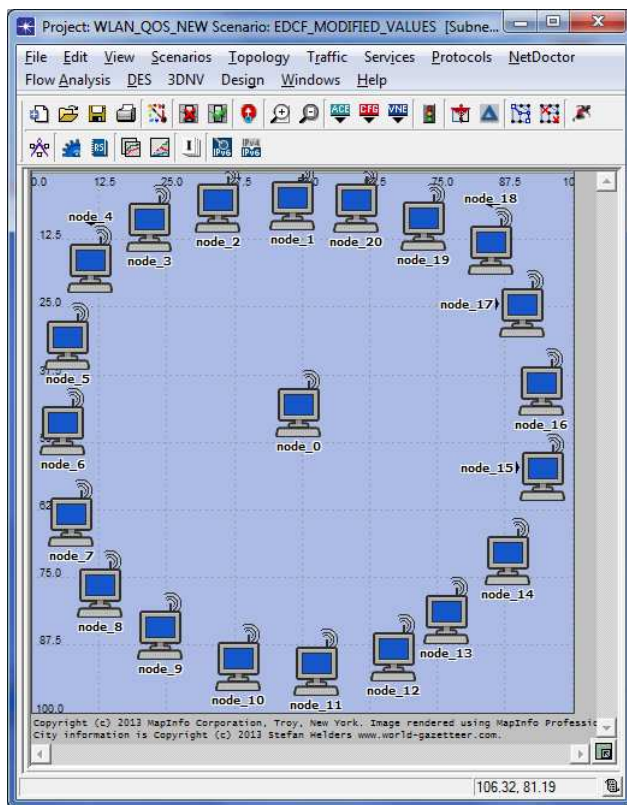

Figure 4.1 : An illustration of the simulated wireless network topology.

4.2 OPNET MODELER

OPNET modeler version 14.5 provides a virtual environment for modeling, analyzing, and predicting the performance of IT infrastructures, including applications, servers, and networking technologies. It has a graphical interface for building networks from physical setup to application processes. To achieve this, a number of tools known as ‘Editors’ are available. These Editors handle the required information similar to real-world network systems. A description of the function and operations of these Editors is given below (Peterson, 1995).

4.2.1 OPNET’s Project Editor

The OPNET’s Project Editor is used to develop network models. Network models are made up of subnets and node models. This editor also includes basic simulation and analysis capabilities. The Project Editor provides the workspace for creating a network simulation. From this editor, a network model was built using models from the standard library, chose statistics about the network, ran a simulation and the results viewed. It is also possible to create node and process models, build packet formats, and create filters and parameters, using specialized editors that can be accessed from the Project Editor. Figure 4.2 shows an example of the project editor.

When creating new network model, a Project is created and scenario Project. A project can have a group of related scenarios that each explores different aspect of network model. More scenarios can be created as new scenarios or duplicating an existing scenario.

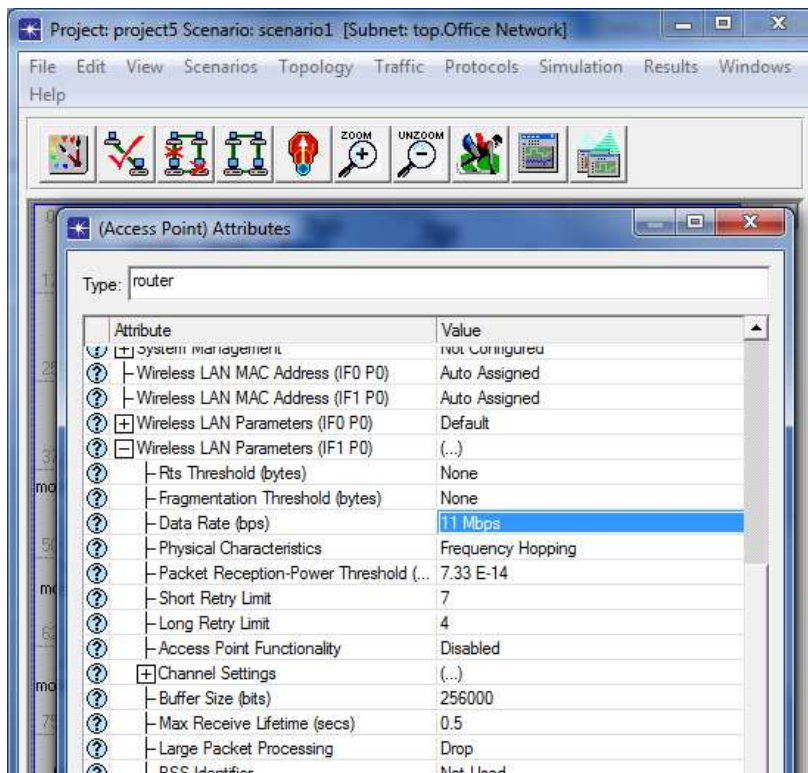

Figure 4.2 OPNET’s Project Editor

4.2 Network Nodes

Using OPNET, the networks models were first created. This was achieved by placing individual nodes from the object palette into the workspace, using the rapid configuration. Node models are objects in a network model. They are made up of modules with process models. The OPNET's Node Editor lets you define the behavior of each network object. Behavior is defined using different modules, each of which models some internal aspect of node behavior such as data creation, data storage, etc. A network object is typically made up of multiple modules that define its behavior. Figure 4.3 illustrates some parts of a node's structure, such as a TCP module, an UDP module and an IP module.

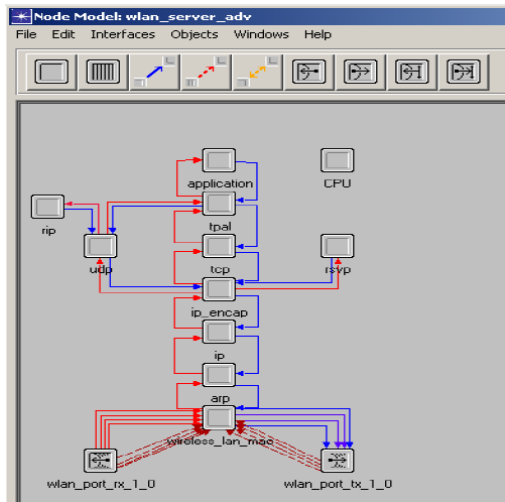

Figure 4.3 Node Structure

Application Module – This module is used to define the various application that will be supported by the workstation. Examples of these applications include Database, email, Print, Remote login, FTP, HTTP, Voice, Interactive video etc.

RIP Process Module - Specifies whether the RIP process is silent or active. Silent RIP processes do not send any routing updates but simply receive updates. All RIP processes in a workstation should be silent RIP processes. This capability will not be used in this project.

IP Module – Used for the defining the source and the destination IP addresses of the host.

RSVP – This in QoS to define the integrated services quality of service model where a station requests for specific QoS parameter before transmission of data or before a call is setup.

TCP Module - Specifies the TCP/IP configuration settings for the node.

4.2.3 Process Editor

This is used to develop process models which control the behavior of the modules. This editor enables the creation of process models which controls the underlying functionality of the node models created in the Node Editor.

Process models are created using finite state machines (FSM) and created using icons that represent states and lines

that represent transition between states. Operations performed in each state or for a transition are described in embedded C or C++ code blocks.

4.3 INPUT DATA

Upon building the network, the two different types of traffic were introduced using the simulator by manual specification.

4.3.1 Real-Time Transport Protocol (RTP) Traffic

RTP traffic typically runs on top of UDP where the sending side encapsulates a media chunk with an RTP packet then encapsulates the packet in a UDP segment after which it hands the segment to IP. The receiving side extracts the RTP packet from the UDP segment, then extracts the media chunk from the RTP packet and finally passes the media chunk to the media player for decoding and rendering (Kurose et al., 2008).

RTP also consists of a control part is called Real-Time Transport Control Protocol (RTCP). RCTP packet are sent periodically and contains sender and/or receiver report that announce statistics that can be useful to the application. These statistics include number of packets sent, number of packet dropped, inter-arrival jitter experienced and delay. These statistics are therefore useful in this research to determine how the QOS is handled by the network.

In this research voice traffic was PCM-encoded (that is sampled, quantized, and digitized) at 64kbps. The traffic will further be sampled for 20 ms chunks giving a payload of 160 bytes as shown below.

$$64000/8 * 20/1000 = 160 \text{ Bytes}$$

This traffic was then randomly transmitted to the rest of the wireless nodes through the access point.

4.3.2 TCP Traffic

TCP traffic was generated from the low priority senders and sent to the wired node over the same wireless media as the high priority traffic. This QOS behavior was observed as the two compete for the use of the shared resources. Metrics relating to the available bandwidth, packet loss, re-transmission attempts, delays were measure and used for analysis.

4.4 PROCESS DESIGN

Traffic statistics were collected based on the following: Network Delay, Network Load, Throughput and Media Access Delay.

Network Delay	Represent end to end delay of all the packets that received by the WLAN nodes and it forwards all the packets to the higher layer. When the Access Point enabled this delay includes medium access delay at the source MAC, reception of all the fragments individually, and transfers of the frames via Access Point.

Load	This indicates total number of bits submitted to wireless LAN layers.
Network Throughput	The throughput is an average rate of successful message delivery over a physical or logical link or passes through a certain network node. It is typically measured in bits per second.
Media Access Delay	Represent the global statistics for the total of queuing and contention delays of the data.

4.5 SIMULATION

The last thing involved the configuration of simulation parameters. Simulations were executed several times to validate the generated results. There are different ways of analysis that can be achieved using OPNET modeler as listed below:

- (i) Using the Discrete Event Simulation (DES)
- (ii) Flow analysis
- (iii) Failure Impact Analysis
- (iv) NetDoctor Validation

Using the Discrete Event Simulation gives more detailed results but requires more processing time as it handles explicit traffic, conversation pair traffic and link loads. The other simulation types answer specific type of questions and generate results much faster than the DES. Flow Analysis for instance handles only conversation pair traffic. To execute DES the following steps were followed:

- (i) From the 'Project' menu, select 'Simulation' button the 'Configure Discrete Event Simulation', this brings up another menu similar to what is shown in the Figure 4.4.

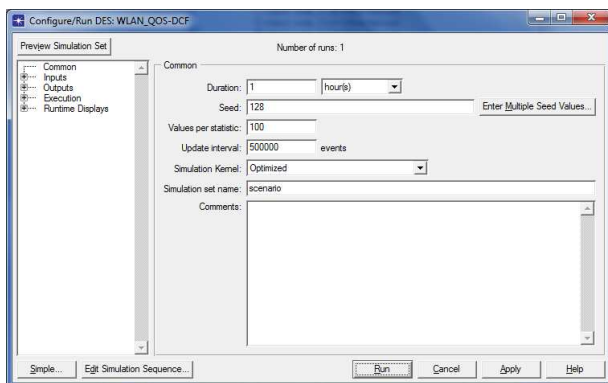

Figure 4.4 – Simulation parameters

- (ii) Set the 'Duration' of the simulation to the required period eg 30.0 minutes
- (iii) Pressing 'OK' set the simulation parameters, while,
- (iv) Selecting 'Run' command starts the simulation.

The following simulation was used to observe the following scenarios.

4.5.1 Scenario 1

This scenario involved observation of the traffic statistics mentioned above (network delay, load, throughput and media access delay) on a non-QoS-enabled network with an objective is creating a baseline of traffic performance.

4.5.2 Scenario 2

This scenario involved replicating the first scenario and introduction of QoS. Traffic was then be generated from two access categories (high-priority and low-priority traffic) and their performance compared against statistics of non-QoS-enabled wireless network.

4.5.3 Scenario 3

This scenario was used to investigate the impact of changing the default QoS parameters (EDCA values) for a given access category. For a reasonable comparison to be undertaken, the topology in scenario 2 was duplicated and new values entered. Data was thereafter generated and the resulting impact measured either using the throughput, delay or packet loss.

CHAPTER 5: SIMULATION RESULTS AND DISCUSSIONS

To investigate the EDCF performance, the simulations described below were executed using OPNET Simulator to measure the following metrics: Network Delay, Network Load, Throughput and Media Access Delay. All wireless stations were located in such a way that every station was able to detect a transmission from any other station, and there was no mobility in the systems. This means that the results were not impacted by mobility and phenomenon such as the hidden node problem.

5.1 SIMULATION SCENARIO 1: NORMAL WIRELESS NETWORK WITHOUT ANY QUALITY OF SERVICE

The objective of this part was to simulate a normal wireless network without any quality of service. Two types of services were introduced in the network for the purpose of measuring their performance in normal conditions, as shown in Figure 5.1. Each station was configured to transmit data randomly to different hosts. Note that the rate of the packet generation within the station was for the two types of services. The reason behind this was to create an environment where all the stations generated packets for the different types of services at the same rate.

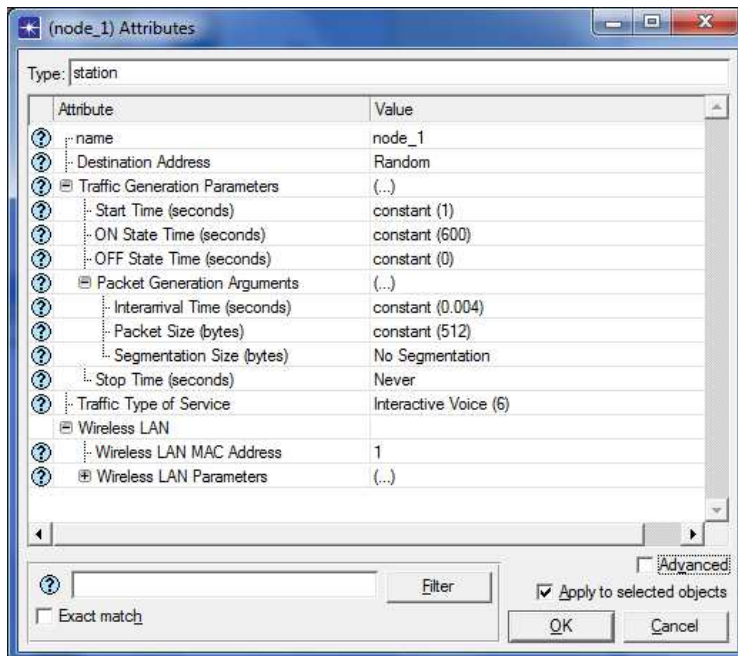

Figure 5.1 Traffic set parameters - Parameters used to generate traffic at 1Mbps

The first 10 nodes were configured to generate voice traffic with a type of service value (TOS) of 6. The other nodes from 11-20 were configured to generate best effort.

Figure 5.2 shows the general WLAN parameters used, included among them are:

- (i) Data rate for the wireless network at 11 Mbps
- (ii) Spread spectrum technique of DSSS
- (iii) Transmission power of 0.005
- (iv) The disabled HCF that provides support for the QoS

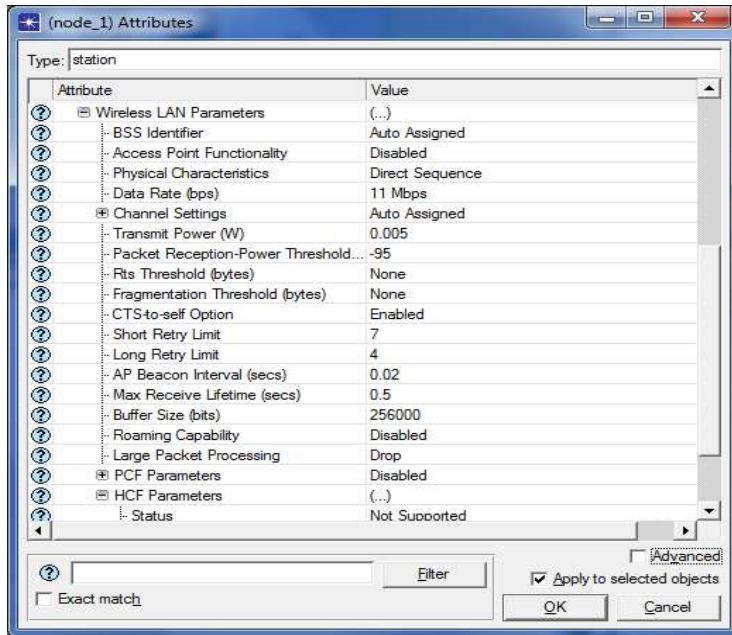

Figure 5.2: WLAN parameters used in the simulation

After running the simulations for one hour, it was observed from the generated parameterized graphs that the network throughput experienced by nodes transmitting different traffic types was almost the same when HCF is not supported (Figure 5.3).

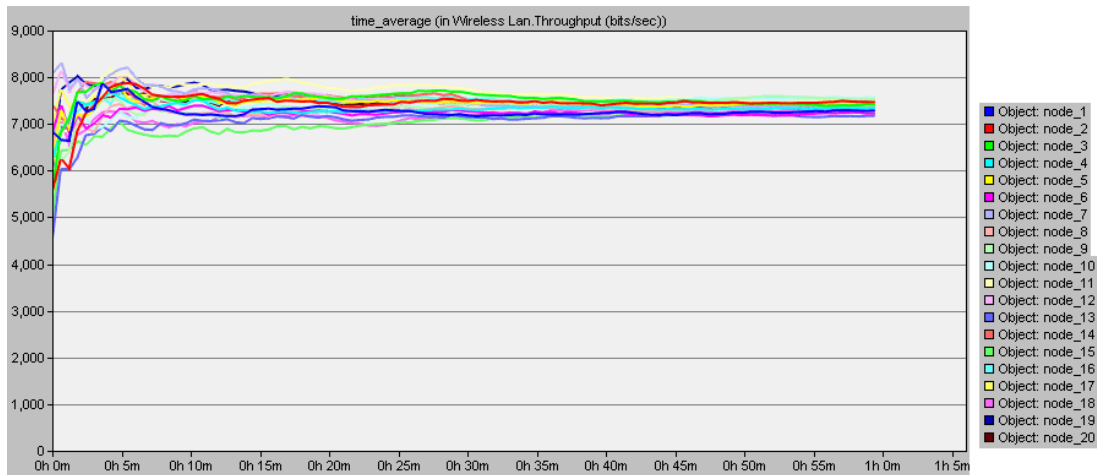

Figure 5.3: Network throughput

The average network throughput (148,491.32 bps) observed at the AP is shown on figure 5.4.

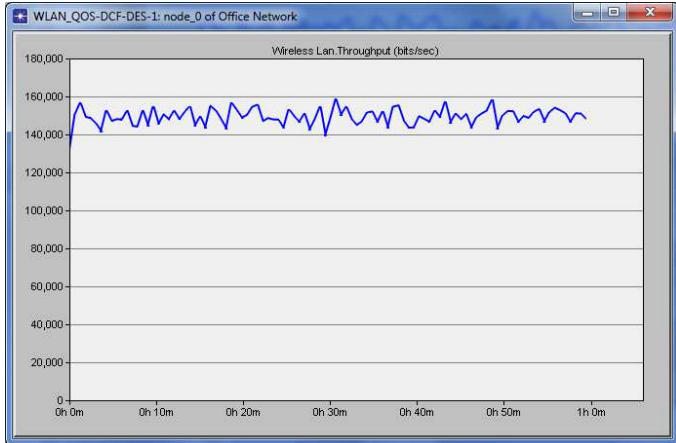

Figure 5.4: Access Point (AP) Throughput

Similarly as demonstrated by figure 5.5, there was no substantial difference in delay experienced by all the 20 nodes transmitting interactive voice (node 1-10) and best effort traffic (node 11-20) .

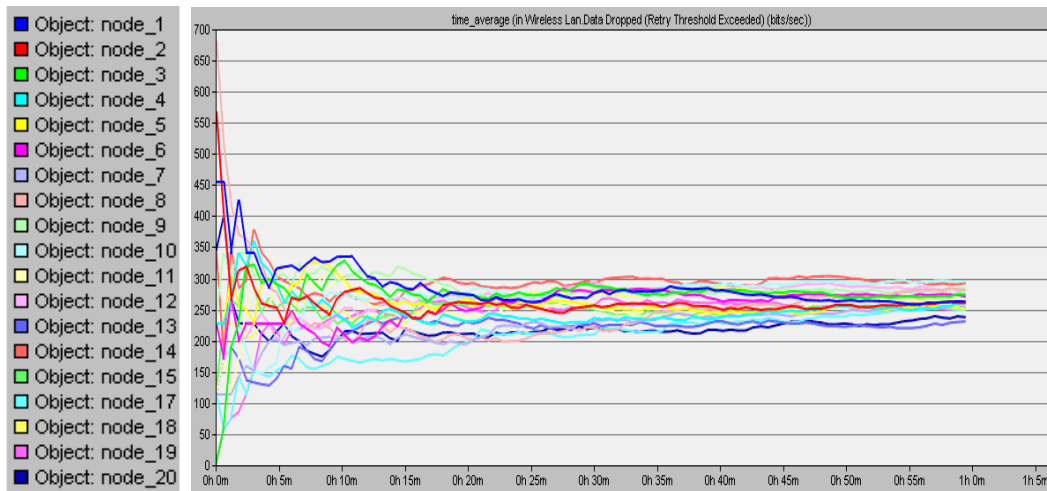

Figure 5.5 : Dropped Traffic in bps at each STA

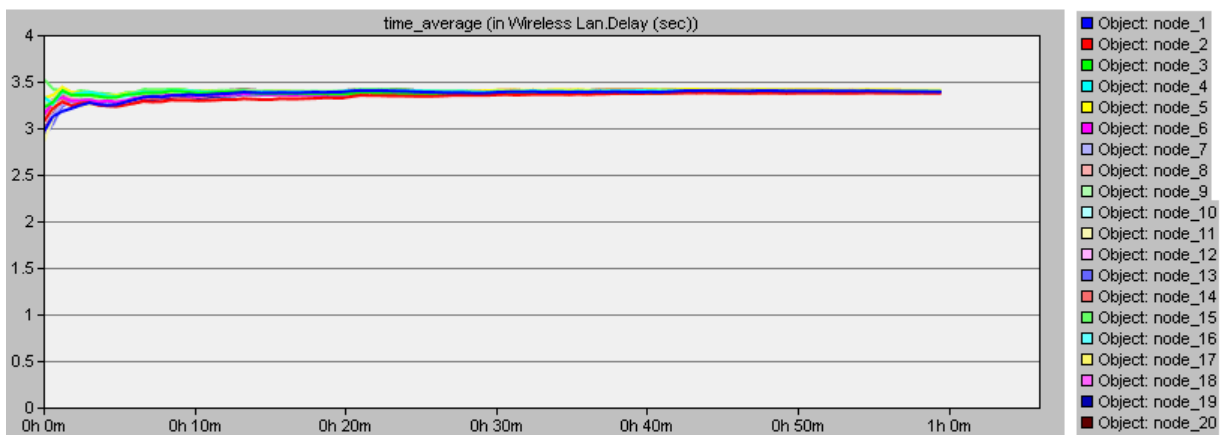

Figure 5.6 Delay experienced by different traffic flows

Figure 5.6, also shows small variance in delays from all the nodes indicative of DCF providing fairness to all traffic flows irrespective of the type of traffic carried.

5.2 SIMULATION SCENARIO 2: IMPACT OF EDCF ON DIFFERENT ACCESS CATEGORIES

The next set of simulations involved the same number of stations (20) and the one Access Point. With HCF enabled operating with the default QoS parameters for AIFS, CWmin, CWmax and TXOP , investigation involved generating equal amount of both interactive and best effort traffic. QoS indicators were later analyzed in graphs below.

It was observed as shown in figure 5.7 that the throughput of high priority Access Category (3,362,417bps) was much higher than the low priority Access Category (12,694bps). It can be concluded that throughput for applications like Voice over IP and video conferencing, EDCF provides better throughput by providing them more priority over the other services like simple HTTP and FTP.

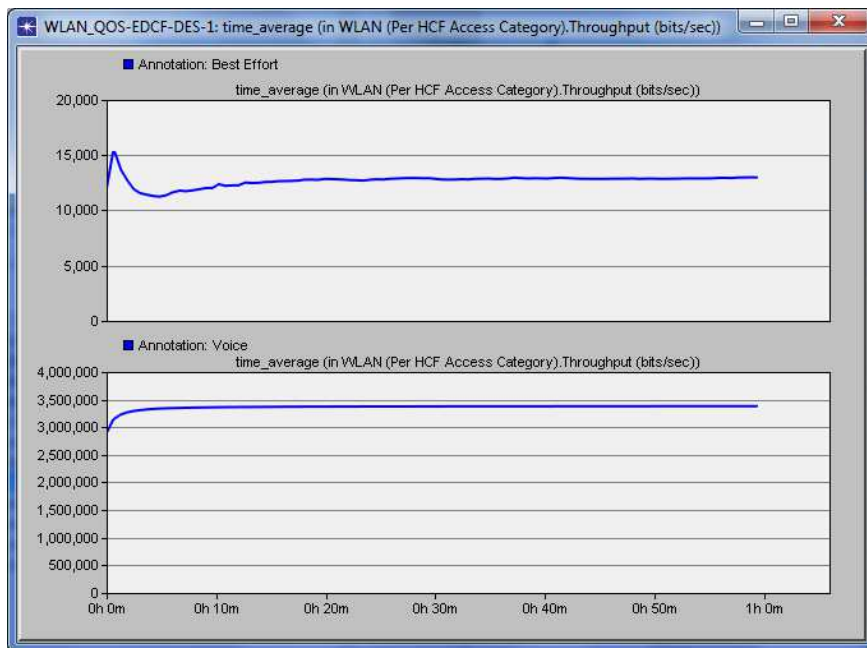

Figure 5.7: Throughput for Voice (Average: 3,362,417bps) and Best Effort (Average: 12,694bps) Traffic

In terms of delay, in figure 5.8, depicts clearly that the performance of low priority traffic degrades by experiencing much higher delays over time.

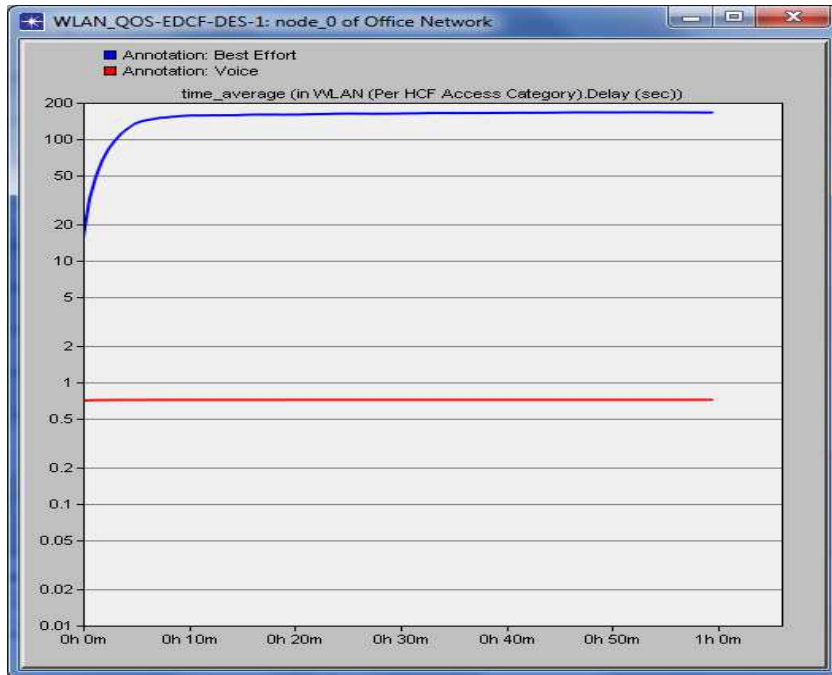

Figure 5.8 WLAN delay

Best Effort traffic continued to suffer higher packet loss as voice traffic receives preferential treatment, figure 5.9 show the difference in data loss from data dropped by all the 802.11e-capable WLAN MACs (QSTAs) in the network due to consistently failing retransmissions. This statistic reports the number of the higher layer packets that are discarded because the MAC couldn't receive any ACKs for the (re)transmissions of those packets or their fragments, and the packets' short or long retry counts reached the MAC's short retry limit or long retry limit, respectively. The average data loss for the voice traffic is at a low of 144.63 bps while the data loss for the BE traffic is at 281.72 bps.

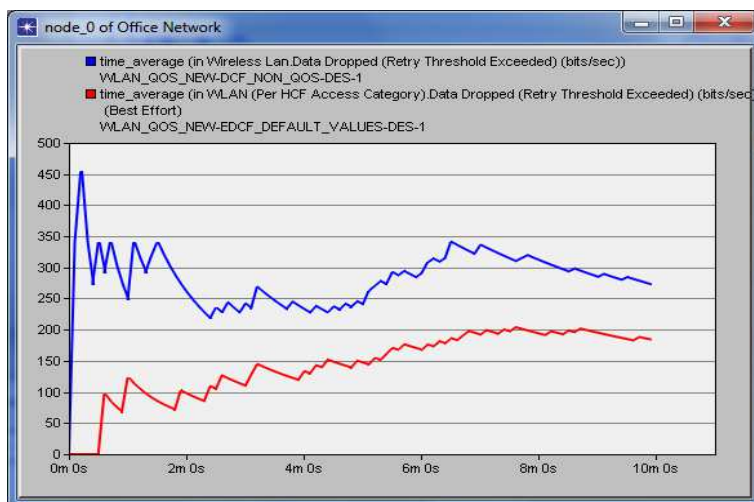

Figure 5.9 – Comparison of packet loss between Voice and Best Effort traffic.

5.3 SIMULATION SCENARIO 3: IMPACT OF CHANGED QOS PARAMETERS

As mentioned earlier this scenario involves configuration of different QoS values, data generation and studying the resulting impact, this is measured either using the throughput, delay or packet loss.

5.3.1 Changing the AIFS Number

The effect of changing the AIFS Number of the BE category from the default 3 to 7 was investigated. Figure 5.10 shows the current parameters used and how they can be changed.

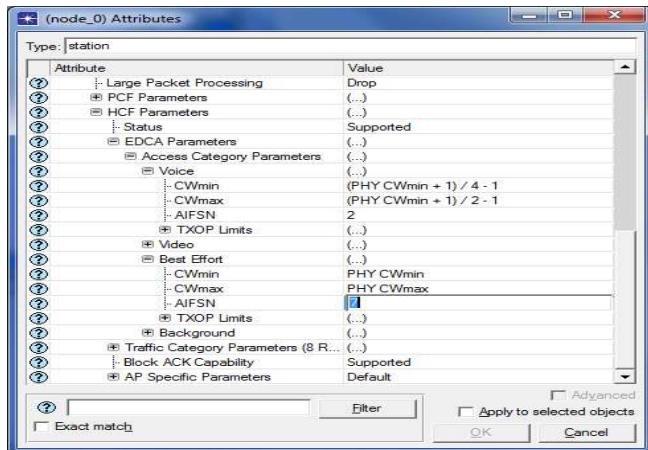

Figure 5.10: EDCA Parameters

Figure 5.11 (a), (b) shows the effect of that change in terms of throughput. It is clear that as the throughput for the Voice improves a direct inverse effect on the Best Effort traffic is experienced.

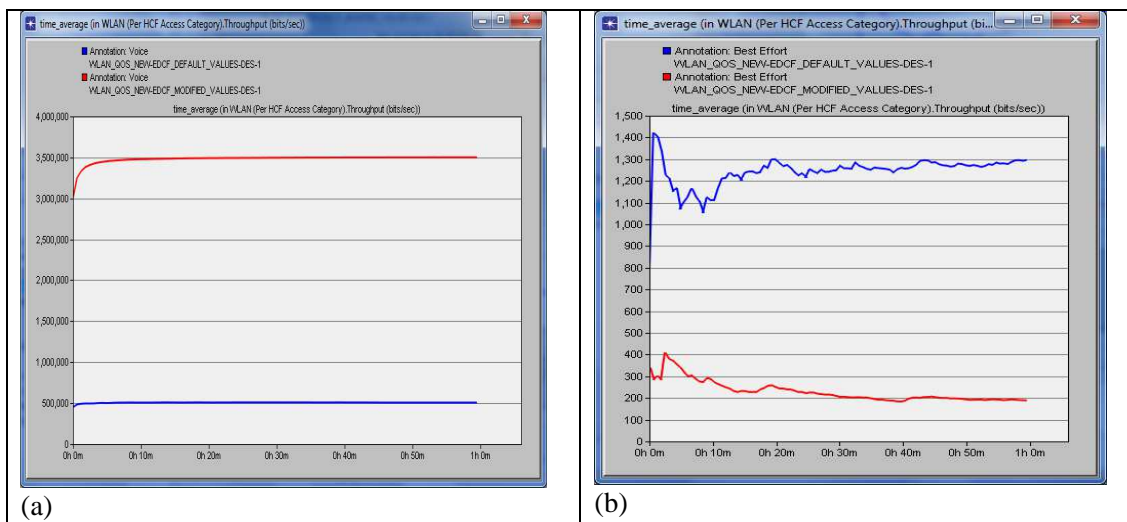

Figure 5-11: Throughput effect on changing the AIFS Number of the Voice and Best Effort ACs

Similar effects were observed in terms of delay where there is a reduction of delay for the Voice AC (figure 5.12 a) and on the other hand increased delay for the Best Effort category (figure 5.12 b)

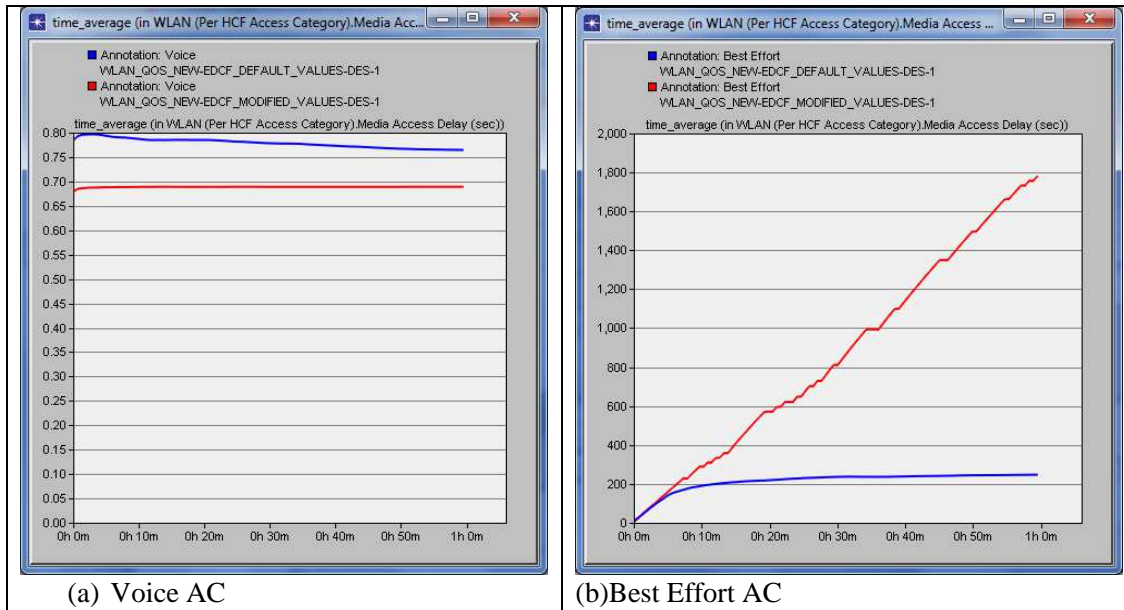

Figure 5.12: Delay effect on changing AIFSN

5.3.2 Changing the size of contention windows

The next lab investigated the implication of changing the size of contention windows used by the QSTA to initially determine the wait period (CW_{min}) and backoff time (CW_{max}) when there is a collision. The impact was measured using the throughput metric.

Figure 5.13 (a) and (b) demonstrate that by reducing the size of the contention window to 1 (one) from the previous value of $(PHY\ CW_{min} + 1) / 4 - 1$, the throughput for voice (AC-6) drastically increases while that of best effort (AC-0) decreases.

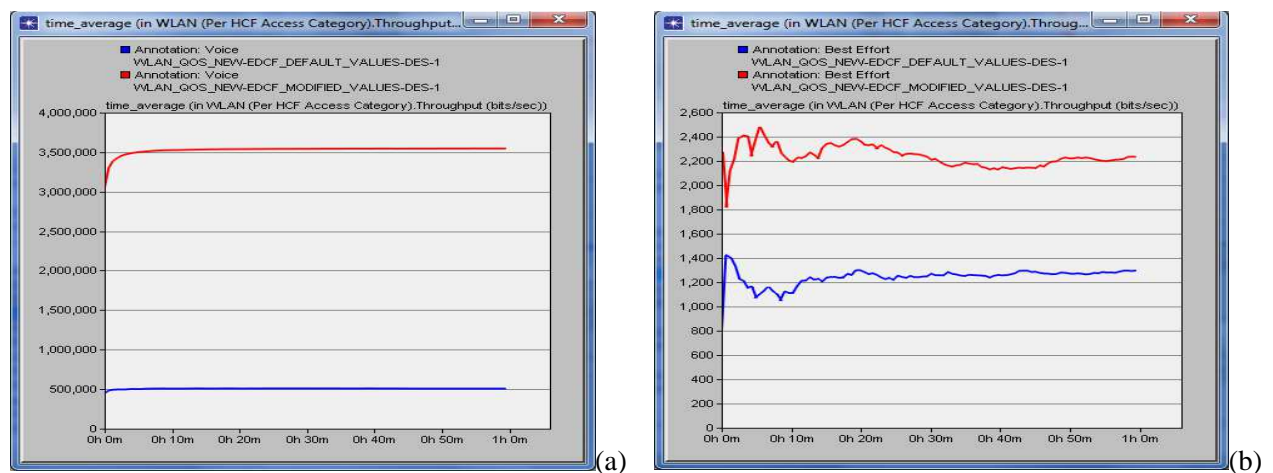

Figure 5.13 (a) and (b) Changed CW_{min} size

5.3.3 Modifying Transmission opportunity (TXOP)

Transmission opportunity was independently modified to favour Voice – this was done by increasing TXOP number that determines the duration from 3264 to 6016. In Opnet the setting are modified using the menu shown in Figure 5.14 below.

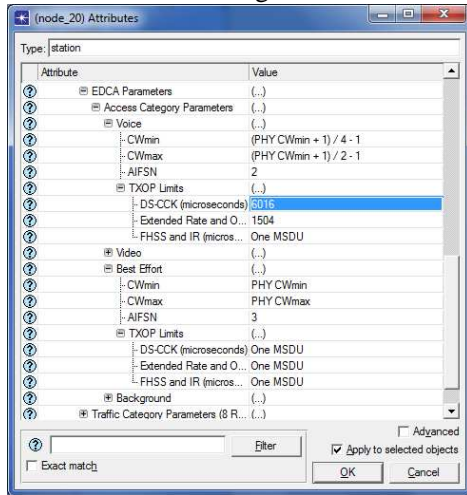

Figure 5.14 Modification of Transmission Opportunities (TXOP)

From the output observed it is clear that the TXOP value affects, by simply changing this value to favor Voice the resources available for the best effort category are drained. Figure 5.15 corroborates this in respect to delays experienced. It was noted that as the delay for the BE gradually increases, the delay for the voice traffic decreases.

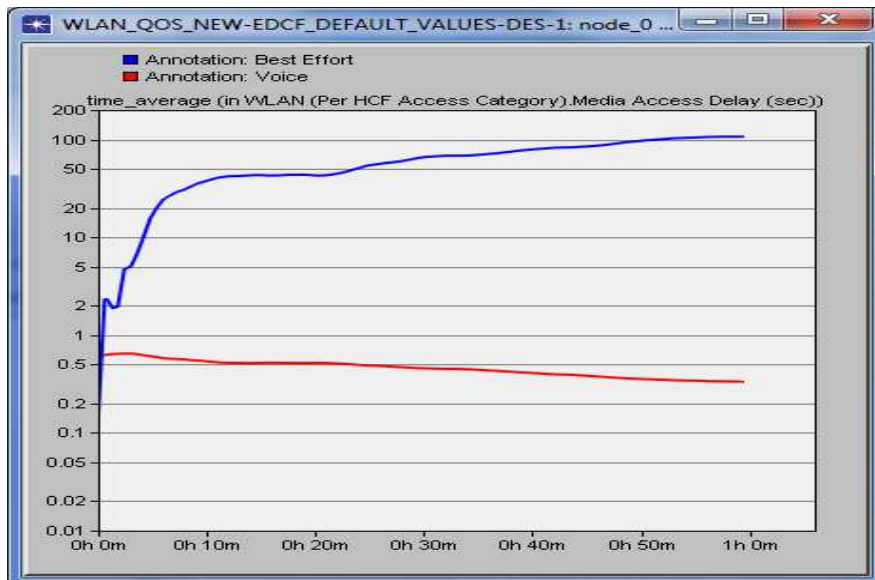

Figure 5.15 Effects of changing TXOP on delay

CHAPTER 6: CONCLUSIONS & RECOMMENDATIONS

6.1 ASSESSMENT OF THE VALUE OF THIS STUDY

This research has given insights in the operation of WLANs and demonstrated that the current QoS was developed to cater for the priority treatment of high-priority but not much consideration was given to the low priority traffic which could include important business traffic.

The results achieved from the experiments performed here add to the knowledge base of WLANs and practically demonstrates the limitations of 802.11e QoS from the perspective of managing low priority traffic.

The results of this thesis could further be used as guideline to stakeholders in the wireless industry in designing and developing more efficient solution that bring about better end user experience in converged network environment offering preferential treatment to high priority traffic and fairness to all traffic types.

6.2 LIMITATIONS OF THE RESEARCH

This research was constrained by tight academic schedule and therefore covered only those aspects that could be explored within the time allocated. This research did not for instance concentrate on developing new algorithms that could be used to introduce fairness in transmission of traffic.

6.3 CONCLUSIONS

Wireless networks are increasingly being implemented due to flexibility and mobility of clients as well as servers. The technology is currently deployed on virtually every smart phone. In this work, evaluation of the performance of 802.11e WLAN scenarios in Opnet Modeler 14.5 was carried out. QoS indicators, namely throughput, delay, packet loss experienced in the simulated WLAN were evaluated in a converged network of high priority traffic as well as low priority traffic, generating data simultaneously.

First, a study on operation of QoS features on WLANs was done including the point coordination function (PCF) and HCCA that offer contention free mechanism for providing differentiated services. The two mechanism however do not offer the required services and it was noted that some vendor do not even support them.

The current solution is the enhanced distributed coordinated function (EDCF) standardized by IEEE as the IEEE802.11e. With EDCF, QoS is provided through the use Access Categories (AC) where each AC or traffic queue is assigned different QoS parameters to enable it get more preferential treatment when contesting for resources.

The different parameters for achieving priority treatment includes the arbitration inter-frame spacing (AIFS), size of the contention window which in turn statistically determines the back-off duration, and the transmission opportunity (TXOP) limit which determines the duration in which a station can keep on

transmitting data upon gaining access to media. The operation of EDCF was thereafter investigated using OPNET modeler.

The first scenario involved an investigation on how low priority traffic perform in DCF and it was confirmed that this class of traffic received fairness in that environment. The simulations results indicated no difference in terms of throughput, delay and packet loss between low and high priority traffic like voice.

The other scenario investigated the impact of the WLANs MAC QoS protocol in a converged environment where both low priority and high-priority traffic shared the same resources. Whereas the 802.11e performs tremendously well in provision of differentiated services, the low-priority traffic on the other hand suffers from diminishing resources with can lead to starvation.

The third scenario involved changing the default EDCF parameters to more favorable values for voice and in turn less favorable for the low priority traffic. This proved that the less priority traffic continued to suffer from constrained resources.

6.4 RECOMMENDATIONS FOR FURTHER RESEARCH

Considering the results and the observed patterns arising from these experiments, more accurate mathematical models can be created to corroborate these results. Such models can be used to come up with more proven values for different network scenarios and technologies. Further experiments can be performed using the newer 802.11n standard to find out whether similar results can be replicated.

Since this research was done in a simulated environment, in future it can be done in a real wireless network where various factors that contribute to general WLANs performance will not be overlooked, this way more practical results could be arrived at.

The radio frequency resources reduces as more users with new bandwidth requirements join the network thereby degrading the quality of the existing services, more research into admission control mechanisms that limit the number of users contesting for the limited bandwidth needs to be done. In an extended service set with multiple access point, such an algorithm will not only help in maintaining quality service for the high priority traffic but can also be used as factor when clients are forming association with access points.

LIST OF REFERENCE

- Almquist, A. and Lindgren, A., 2001. Quality of Service Schemes for IEEE 802.11: A Simulation Study. Msc. Lulea University of Technology.
- Ammar Abbas, Ibrahim Hussain and Osama Hussain, 2010. Fairness and Quality of Service Issues and Analysis of IEEE 802.11e Wireless LAN. International Journal of Information and Communication Engineering.
- Abu-Tair, M.I. and Geyong M., 2006. Performance evaluation of an enhanced distributed channel access protocol under heterogeneous traffic, Parallel and Distributed Processing Symposium, 2006. IPDPS 2006. 20th International, vol., no., pp.7 pp., 25-29 April 2006.
- Bianchi, G., Fratta, L. and Oliveri, M., 1996. Performance Evaluation and Enhancement of the CSMA/CA MAC Protocol For 802.11, Seventh IEEE International Symposium on Personal, Indoor and Mobile Radio Communications, Proceedings, (PIMRC '96), Vol. 2, p.392-396.
- Bianchi, G., 2011. Understanding 802.11e contention based prioritization mechanisms and their coexistence with legacy 802.11 stations . IEEE Network. International Journal of Computer Applications (0975 – 8887). Volume 22- No.9, May 2011.28-34
- Dazhi C. and Pramod K. V., 2004. QoS Support in Wireless Sensor Networks: A Survey. New York:University Syracuse.
- D-J. Deng and R-S. Chang. A priority scheme for IEEE 802.11 DCF access method. IEICE Transactions on Communications, E82-B(1), January 1999.
- Feigin, J. and Pahlavan, K., 1999. Measurement of Characteristics of Voice Over IP In A Wireless LAN Environment. IEEE International Workshop on Mobile Multimedia Communications, 1999. (MoMuC '99), p236-240.
- Grilo, A., and Nunes, M., 2002. Performance evaluation of IEEE 802.11e, Personal, Indoor and Mobile Radio Communications. The 13th IEEE International Symposium on , vol.1, no., pp. 511- 517 vol.1, 15-18 Sept. 2002.
- Gupta, J. S. and Grewal, G.S., 2010. Performance evaluation of IEEE 802.11 MAC layer in supporting delay sensitive services. IJWMN. (February 2010) 42-53.
- IEEE, 2007. Standard for Information Technology - Telecommunications and Information Exchange Between Systems - Local and Metropolitan Area Networks - Specific Requirements - Part 11: Wireless LAN Medium Access Control (MAC) and Physical Layer (PHY) Specifications, IEEE Std 802.11-2007 (Revision of IEEE Std 802.11-1999).

ITU, 2011. ITU World Telecommunications, ICT Facts and Figures [pdf]. Available at: < www.itu.int/ITU-D/ict/material/FactsFigures2010.pdf > [Accessed 30 October 2012].

Iqbal, Z. Wireless LAN Technology: Current State and Future Trends, 2002. Ad Hoc Mobile Wireless Networks – Research Seminar on Telecommunications Software, Espoo: Helsinki University of Technology
Jangeun Jun; Sichitiu, M.L., 2003. Fairness and QoS in multihop wireless networks. *Vehicular Technology Conference, 2003. VTC 2003-Fall. 2003 IEEE 58th* , vol.5, no., pp. 2936- 2940 Vol.5, 6-9 Oct. 2003 doi: 10.1109/VETEFCF.2003.1286161.

J. L. Sobrinho and A. S. Krishnakumar. Real-time traffic over the IEEE 802.11 medium access control layer. Bell Labs Technical Journal, pages 172–187, Autumn 1996.

Kurose F., Ross K., 2008. Computer Networking- A top down Approach. 4th Ed. Boston : Pearson Addison Wesley.

Lindgren, A., Almquist, A. and Schelen, O., 2001. Quality of Service Schemes for IEEE 802.11

Lu Yang, 2004. P-HCCA: a new scheme for real-time traffic with QoS in IEEE 802.11e based networks. APAN Network Research Workshop .

Manzoor, M., 2008. A Performance Evaluation of the Quality of Service (Wireless LAN) Standard IEEE 802.11e. Master's Degree. UMEA University.

Nam Young-Woo, Kim Sunmyeng, and Kim Si-Gwan. 2012. Fairness Enhancement Scheme for Multimedia Applications in IEEE 802.11e Wireless LANs. *International Journal of Advanced Computer Science and Applications*, Vol. 3, No.2, 2012.

Niemegeers, G. and Heemstra, G., 2003. Research Issues in Ad Hoc Distributed Personal Networks. *International Journal on Wireless Personal Communications*, Kluwer Academic Publishers.

Ohrman, F., 2004. Voice over 802.11. Norwood: Artech House Inc.

OPNET Modeler, 2012. Wireless Network Modeling and Simulation[online]. Available at: < <http://www.opnet.com/> > [Accessed 22 Nov, 2012].

Pan, J., 2008. A Survey of Network Simulation Tools: Current status and Future Developments [pdf]. Available at: <<http://www.cse.wustl.edu/~jain/cse567-08/ftp/simtools.pdf>> [Accessed 22 Nov, 2012]

PLANET3 Wireless, Inc., 2002. Certified Wireless Network Administrator, Official Study Guide. Georgia: Planet3 Wireless, Inc.

Peterson R., et al. (1995). Introduction to spread spectrum communications. Prentice Hall.

Prasad, A., & Prasad, N., 2005. IEEE 801.11 WLANs and IP Networking, Security, QoS and Mobility. Boston: Artech House.

Priyank, G., et al., 2002. Achieving Higher Throughput and QoS in 802.11 Wireless LANs. Stanford University Whitepaper.

Ranjba, A., 2007. CCNP ONT Official Exam Certification Guide. Indianapolis: Cisco Press.

Sharma K., Bhatia N., Kapoor N., 2011. Performance Evaluation of 802.11 WLAN Scenarios in OPNET Modeler. International Journal of Computer Applications (0975 – 8887) Volume 22– No.9, May 2011

Sobrinho Joao L., Krishnakumar A. S., 1999. Quality-of-Service in Ad Hoc Carrier Sense Multiple Access Wireless Networks”, IEEE journal on selected areas in communications, vol. 17, no. 8, august 1999.

Stallings, W., 2005. Wireless Communication and Networks . 2nd ed. Upper Saddle River, NJ:Pearson Education Inc.

Turban, E., King, D., McKay, J., Marshall, P., Lee, J., and Viehland, D., 2008. Electronic Commerce, a managerial perspective. New Jersey: Pearson Prentice Hall.

APPENDICES

APPENDIX A: PROJECT SCHEDULE

Activity / Time (wks)	2	4	6	8	10	12	14	16	18	20	22	24	26
Write introduction	█	█											
Literature Review		█	█										
Methodology			█										
Defend proposal			█										
Conduct research				█	█								
Analyze data						█	█	█	█				
Progress presentation									█	█			
Make conclusions & Recommendations										█	█	█	
Final Presentation												█	█

APPENDIX B : STATISTICAL DATA

(i) Data for figure 5.9

```
zone      : 0
statistic : 'WLAN_QOS_NEW-DCF_NON_QOS-DES-1: Office Network.node_0.Wireless Lan.Data Dropped (Retry Threshold Exceeded) (bits/sec)'
length    : 101
number of values : 101
horizontal, min : 0
           max  : 600
vertical, min  : 0.0
           max  : 455.111111111
initial value : 0.0
final value   : 273.066666667
expected value : 281.716835018
sample mean   : 281.716835018
variance      : 2,336.48335408
standard deviation : 48.3371839693
** confidence intervals valid if entries are independent samples
80% conf interval: [ 275.490732792, 287.942937245 ]
90% conf interval: [ 273.725310235, 289.708359802 ]
95% conf interval: [ 272.195018255, 291.238651782 ]
98% conf interval: [ 270.413564068, 293.020105969 ]
99% conf interval: [ 269.207305342, 294.226364695 ]
** Operations List **
Original vector : WLAN_QOS_NEW-DCF_NON_QOS-DES-1: Office Network.node_0.Wireless Lan.Data Dropped (Retry Threshold Exceeded) (bits/sec).none
-----
Operation #1
Operation type : Filter
Filter name    : time_average
-----
zone      : 0
statistic : 'WLAN_QOS_NEW-EDCF_DEFAULT_VALUES-DES-1: Office Network.node_0.WLAN (Per HCF Access Category).Data Dropped (Retry Threshold Exceeded) (bits/sec) <Best Effort>'
length    : 101
number of values : 101
horizontal, min : 0
           max  : 600
vertical, min  : 0.0
           max  : 203.913419913
initial value : 0.0
final value   : 184.32
expected value : 143.187194696
sample mean   : 143.187194696
variance      : 2,840.16119929
standard deviation : 53.2931627818
** confidence intervals valid if entries are independent samples
80% conf interval: [ 136.322734415, 150.051654977 ]
90% conf interval: [ 134.376304276, 151.998085116 ]
95% conf interval: [ 132.689112493, 153.685276898 ]
98% conf interval: [ 130.725007012, 155.64938238 ]
99% conf interval: [ 129.395071394, 156.979317998 ]
** Operations List **
Original vector : WLAN_QOS_NEW-EDCF_DEFAULT_VALUES-DES-1: Office Network.node_0.WLAN (Per HCF Access Category).Data Dropped (Retry Threshold Exceeded) (bits/sec) <Best Effort>.none
-----
Operation #1
Operation type : Filter
Filter name    : time_average
-----
```

(ii) Data for figure 5-11 (a): The effect of changing the AIFS Number of the Voice and Best Effort ACs

```
zone          : 0
statistic     : 'WLAN_QOS_NEW-EDCF_DEFAULT_VALUES-DES-1: WLAN (Per HCF Access Category).Throughput
(bits/sec) <Voice>'
length        : 101
number of values : 101
horizontal, min : 0
              max : 3600
vertical, min  : 454,656
              max : 509,601.564444444
initial value  : 454,656
final value   : 507,087.075555556
expected value : 506,568.427377287
sample mean   : 506,568.427377287
variance      : 40,279,304.2702332
standard deviation : 6,346.59785005
** confidence intervals valid if entries are independent samples
80% conf interval: [ 505,750.949738748, 507,385.905015827 ]
90% conf interval: [ 505,519.152474512, 507,617.702280063 ]
95% conf interval: [ 505,318.227493129, 507,818.627261446 ]
98% conf interval: [ 505,084.325300517, 508,052.529454058 ]
99% conf interval: [ 504,925.945386621, 508,210.909367954 ]
** Operations List **
Original vector : WLAN_QOS_NEW-EDCF_DEFAULT_VALUES-DES-1: WLAN (Per HCF Access Category).Throughput
(bits/sec) <Voice>.none
-----
```

```
Operation #1
Operation type : Filter
Filter name    : time_average
-----
```

```
zone          : 0
statistic     : 'WLAN_QOS_NEW-EDCF_MODIFIED_VALUES-DES-1: WLAN (Per HCF Access Category).Throughput
(bits/sec) <Voice>'
length        : 101
number of values : 101
horizontal, min : 0
              max : 3600
vertical, min  : 3,007,146.666666667
              max : 3,500,586.36406619
initial value  : 3,007,146.666666667
final value   : 3,500,544
expected value : 3,479,920.4776958
sample mean   : 3,479,920.4776958
variance      : 3,401,491,853.79688
standard deviation : 58,322.3100863
** confidence intervals valid if entries are independent samples
80% conf interval: [ 3,472,408.23484539, 3,487,432.72054621 ]
90% conf interval: [ 3,470,278.12478621, 3,489,562.83060538 ]
95% conf interval: [ 3,468,431.71678225, 3,491,409.23860935 ]
98% conf interval: [ 3,466,282.26340112, 3,493,558.69199047 ]
99% conf interval: [ 3,464,826.82496498, 3,495,014.13042661 ]
** Operations List **
Original vector : WLAN_QOS_NEW-EDCF_MODIFIED_VALUES-DES-1: WLAN (Per HCF Access Category).Throughput
(bits/sec) <Voice>.none
-----
```

```
Operation #1
Operation type : Filter Filter name : time_average
```

1. Data for figure 5-11 (b): The effect of changing the AIFS Number of the Voice and Best Effort ACs

```

zone          : 0
statistic     : 'WLAN_QOS_NEW-EDCF_DEFAULT_VALUES-DES-1: WLAN (Per HCF Access Category).Throughput
(bits/sec) <Best Effort>'
length       : 101
number of values : 101
horizontal, min : 0
              max : 3600
vertical, min  : 796.444444444
              max : 1,422.222222222
initial value  : 796.444444444
final value    : 1,295.92888889
expected value : 1,241.92838147
sample mean   : 1,241.92838147
variance      : 5,359.28258157
standard deviation : 73.2071211124
** confidence intervals valid if entries are independent samples
80% conf interval: [ 1,232.49889091, 1,251.35787202 ]
90% conf interval: [ 1,229.8251418, 1,254.03162114 ]
95% conf interval: [ 1,227.50750016, 1,256.34926278 ]
98% conf interval: [ 1,224.80947098, 1,259.04729195 ]
99% conf interval: [ 1,222.98258076, 1,260.87418217 ]
** Operations List **
Original vector : WLAN_QOS_NEW-EDCF_DEFAULT_VALUES-DES-1: WLAN (Per HCF Access Category).Throughput
(bits/sec) <Best Effort>.none
-----
Operation #1
Operation type : Filter
Filter name    : time_average
-----

zone          : 0
statistic     : 'WLAN_QOS_NEW-EDCF_MODIFIED_VALUES-DES-1: WLAN (Per HCF Access Category).Throughput
(bits/sec) <Best Effort>'
length       : 101
number of values : 101
horizontal, min : 0
              max : 3600
vertical, min  : 183.402985075
              max : 409.6
initial value  : 341.333333333
final value    : 188.871111111
expected value : 229.665408565
sample mean   : 229.665408565
variance      : 2,282.59429068
standard deviation : 47.7765035418
** confidence intervals valid if entries are independent samples
80% conf interval: [ 223.511525143, 235.819291986 ]
90% conf interval: [ 221.766580359, 237.564236771 ]
95% conf interval: [ 220.254038788, 239.076778342 ]
98% conf interval: [ 218.49324833, 240.8375688 ]
99% conf interval: [ 217.300981434, 242.029835695 ]
** Operations List **
Original vector : WLAN_QOS_NEW-EDCF_MODIFIED_VALUES-DES-1: WLAN (Per HCF Access Category).Throughput
(bits/sec) <Best Effort>.none
-----
Operation #1
Operation type : Filter
Filter name    : time_average

```

2. Data for the figure 5.12 (a)

```

zone          : 0
statistic     : 'WLAN_QOS_NEW-EDCF_DEFAULT_VALUES-DES-1: WLAN (Per HCF Access Category).Media Access
Delay (sec) <Voice>'
length        : 101
number of values : 101
horizontal, min : 0
              max : 3600
vertical, min  : 0.764520582299
              max : 0.79665430253
initial value  : 0.785384842922
final value    : 0.764520582299
expected value : 0.778632710306
sample mean    : 0.778632710306
variance       : 8.55210518093E-005
standard deviation : 0.00924775928586
** confidence intervals valid if entries are independent samples
80% conf interval: [ 0.777441546694, 0.779823873919 ]
90% conf interval: [ 0.777103790095, 0.780161630517 ]
95% conf interval: [ 0.77681101814, 0.780454402473 ]
98% conf interval: [ 0.776470194406, 0.780795226206 ]
99% conf interval: [ 0.776239415751, 0.781026004862 ]
** Operations List **
Original vector : WLAN_QOS_NEW-EDCF_DEFAULT_VALUES-DES-1: WLAN (Per HCF Access Category).Media
Access Delay (sec) <Voice>.none
-----
Operation #1
Operation type  : Filter
Filter name     : time_average
-----
zone          : 0
statistic     : 'WLAN_QOS_NEW-EDCF_MODIFIED_VALUES-DES-1: WLAN (Per HCF Access Category).Media Access
Delay (sec) <Voice>'
length        : 101
number of values : 101
horizontal, min : 0
              max : 3600
vertical, min  : 0.679906689401
              max : 0.689051335438
initial value  : 0.679906689401
final value    : 0.689027365159
expected value : 0.688633922405
sample mean    : 0.688633922405
variance       : 1.16325517852E-006
standard deviation : 0.00107854308144
** confidence intervals valid if entries are independent samples
80% conf interval: [ 0.688494999966, 0.688772844844 ]
90% conf interval: [ 0.688455608257, 0.688812236553 ]
95% conf interval: [ 0.688421462995, 0.688846381815 ]
98% conf interval: [ 0.688381713573, 0.688886131236 ]
99% conf interval: [ 0.688354798435, 0.688913046375 ]
** Operations List **
Original vector : WLAN_QOS_NEW-EDCF_MODIFIED_VALUES-DES-1: WLAN (Per HCF Access Category).Media
Access Delay (sec) <Voice>.none
-----
Operation #1
Operation type  : Filter
Filter name     : time_average

```

(iii) Data for the figure 5.12 (b)

zone : 0
statistic : 'WLAN_QOS_NEW-EDCF_DEFAULT_VALUES-DES-1: WLAN (Per HCF Access Category).Media Access
Delay (sec) <Best Effort>'
length : 101
number of values : 101
horizontal, min : 0
max : 3600
vertical, min : 13.2928567433
max : 247.076647297
initial value : 13.2928567433
final value : 247.073008275
expected value : 213.132490066
sample mean : 213.132490066
variance : 2,466.35216785
standard deviation : 49.6623818181

** confidence intervals valid if entries are independent samples

80% conf interval: [206.735694874, 219.529285258]
90% conf interval: [204.921872017, 221.343108114]
95% conf interval: [203.349626008, 222.915354124]
98% conf interval: [201.519332003, 224.745648129]
99% conf interval: [200.280002847, 225.984977285]

** Operations List **

Original vector : WLAN_QOS_NEW-EDCF_DEFAULT_VALUES-DES-1: WLAN (Per HCF Access Category).Media
Access Delay (sec) <Best Effort>.none

Operation #1
Operation type : Filter
Filter name : time_average

zone : 0
statistic : 'WLAN_QOS_NEW-EDCF_MODIFIED_VALUES-DES-1: WLAN (Per HCF Access Category).Media Access
Delay (sec) <Best Effort>'
length : 101
number of values : 101
horizontal, min : 0
max : 3600
vertical, min : 3.28814742104
max : 1,780.8200944
initial value : 3.28814742104
final value : 1,780.8200944
expected value : 862.826748758
sample mean : 862.826748758
variance : 271,730.956337304
standard deviation : 521.278194765

** confidence intervals valid if entries are independent samples

80% conf interval: [795.683173926, 929.970323591]
90% conf interval: [776.644491736, 949.009005781]
95% conf interval: [760.141506349, 965.511991168]
98% conf interval: [740.929935741, 984.723561776]
99% conf interval: [727.921392021, 997.732105496]

** Operations List **

Original vector : WLAN_QOS_NEW-EDCF_MODIFIED_VALUES-DES-1: WLAN (Per HCF Access Category).Media
Access Delay (sec) <Best Effort>.none

Operation #1
Operation type : Filter
Filter name : time_average

Statistical Data for 5.13 (a)

zone : 0
statistic : 'WLAN_QOS_NEW-EDCF_DEFAULT_VALUES-DES-1: WLAN (Per HCF Access Category).Throughput (bits/sec) <Voice>'
length : 101
number of values : 101
horizontal, min : 0
max : 3600
vertical, min : 454,656
max : 509,601.564444444
initial value : 454,656
final value : 507,087.075555556
expected value : 506,568.427377287
sample mean : 506,568.427377287
variance : 40,279,304.2702332
standard deviation : 6,346.59785005

** confidence intervals valid if entries are independent samples

80% conf interval: [505,750.949738748, 507,385.905015827]

90% conf interval: [505,519.152474512, 507,617.702280063]

95% conf interval: [505,318.227493129, 507,818.627261446]

98% conf interval: [505,084.325300517, 508,052.529454058]

99% conf interval: [504,925.945386621, 508,210.909367954]

** Operations List **

Original vector : WLAN_QOS_NEW-EDCF_DEFAULT_VALUES-DES-1: WLAN (Per HCF Access Category).Throughput (bits/sec) <Voice>.none

Operation #1

Operation type : Filter

Filter name : time_average

zone : 0
statistic : 'WLAN_QOS_NEW-EDCF_MODIFIED_VALUES-DES-1: WLAN (Per HCF Access Category).Throughput (bits/sec) <Voice>'
length : 101
number of values : 101
horizontal, min : 0
max : 3600
vertical, min : 3,058,232.88888889
max : 3,546,313.38666667
initial value : 3,058,232.88888889
final value : 3,546,313.38666667
expected value : 3,526,652.95103715
sample mean : 3,526,652.95103714
variance : 3,316,661,822.9375
standard deviation : 57,590.466424

** confidence intervals valid if entries are independent samples

80% conf interval: [3,519,234.97378271, 3,534,070.92829158]

90% conf interval: [3,517,131.59290392, 3,536,174.30917037]

95% conf interval: [3,515,308.35411245, 3,537,997.54796184]

98% conf interval: [3,513,185.87263679, 3,540,120.0294375]

99% conf interval: [3,511,748.69742434, 3,541,557.20464995]

** Operations List **

Original vector : WLAN_QOS_NEW-EDCF_MODIFIED_VALUES-DES-1: WLAN (Per HCF Access Category).Throughput (bits/sec) <Voice>.none

Operation #1

Operation type : Filter

Filter name : time_average

Statistical Data for 5.13 (b)

zone : 0
statistic : 'WLAN_QOS_NEW-EDCF_DEFAULT_VALUES-DES-1: WLAN (Per HCF Access Category).Throughput (bits/sec)
<Best Effort>'
length : 101
number of values : 101
horizontal, min : 0
max : 3600
vertical, min : 796.444444444
max : 1,422.222222222
initial value : 796.444444444
final value : 1,295.928888889
expected value : 1,241.92838147
sample mean : 1,241.92838147
variance : 5,359.28258157
standard deviation : 73.2071211124
** confidence intervals valid if entries are independent samples
80% conf interval: [1,232.49889091, 1,251.35787202]
90% conf interval: [1,229.8251418, 1,254.03162114]
95% conf interval: [1,227.50750016, 1,256.34926278]
98% conf interval: [1,224.80947098, 1,259.04729195]
99% conf interval: [1,222.98258076, 1,260.87418217]
** Operations List **
Original vector : WLAN_QOS_NEW-EDCF_DEFAULT_VALUES-DES-1: WLAN (Per HCF Access Category).Throughput
(bits/sec) <Best Effort>.none
Operation #1
Operation type : Filter
Filter name : time_average
zone : 0
statistic : 'WLAN_QOS_NEW-EDCF_MODIFIED_VALUES-DES-1: WLAN (Per HCF Access Category).Throughput
(bits/sec) <Best Effort>'
length : 101
number of values : 101
horizontal, min : 0
max : 3600
vertical, min : 1,820.444444444
max : 2,480.355555556
initial value : 2,275.555555556
final value : 2,233.45777778
expected value : 2,236.6814332
sample mean : 2,236.6814332
variance : 7,965.15217382
standard deviation : 89.2477012243
** confidence intervals valid if entries are independent samples
80% conf interval: [2,225.18582535, 2,248.17704105]
90% conf interval: [2,221.92622494, 2,251.43664146]
95% conf interval: [2,219.10075953, 2,254.26210687]
98% conf interval: [2,215.811559, 2,257.5513074]
99% conf interval: [2,213.58437468, 2,259.77849172]
** Operations List **
Original vector : WLAN_QOS_NEW-EDCF_MODIFIED_VALUES-DES-1: WLAN (Per HCF Access
Category).Throughput (bits/sec) <Best Effort>.none
Operation #1
Operation type : Filter
Filter name : time_average

Statistical data for Figure 5.15

```
-----
zone          : 0
  statistic    : 'WLAN_QOS_NEW-EDCF_DEFAULT_VALUES-DES-1: Office Network.node_0.WLAN (Per HCF Access
Category).Media Access Delay (sec) <Best Effort>'
  length       : 101
  number of values : 101
  horizontal, min : 0
                max : 3600
  vertical, min  : 0.15238767287
                max : 106.989220505
  initial value  : 0.15238767287
  final value    : 106.989220505
  expected value : 62.0259861994
  sample mean    : 62.0259861994
  variance       : 867.715993156
  standard deviation : 29.4570194208
  ** confidence intervals valid if entries are independent samples
  80% conf interval: [ 58.2317557717, 65.820216627 ]
  90% conf interval: [ 57.1558948655, 66.8960775332 ]
  95% conf interval: [ 56.2233241846, 67.8286482141 ]
  98% conf interval: [ 55.1376934903, 68.9142789084 ]
  99% conf interval: [ 54.4025909504, 69.6493814484 ]
  ** Operations List **
  Original vector : WLAN_QOS_NEW-EDCF_DEFAULT_VALUES-DES-1: Office Network.node_0.WLAN (Per HCF
Access Category).Media Access Delay (sec) <Best Effort>.none
  Operation #1
  Operation type  : Filter
  Filter name     : time_average
zone          : 0
  statistic    : 'WLAN_QOS_NEW-EDCF_DEFAULT_VALUES-DES-1: Office Network.node_0.WLAN (Per HCF Access
Category).Media Access Delay (sec) <Voice>'
  length       : 101
  number of values : 101
  horizontal, min : 0
                max : 3600
  vertical, min  : 0.333039865275
                max : 0.646655309098
  initial value  : 0.613764878286
  final value    : 0.333039865275
  expected value : 0.463042042048
  sample mean    : 0.463042042048
  variance       : 0.0078029334054
  standard deviation : 0.08833421424
  ** confidence intervals valid if entries are independent samples
  80% conf interval: [ 0.451664096483, 0.474419987612 ]
  90% conf interval: [ 0.448437859421, 0.477646224674 ]
  95% conf interval: [ 0.445641313812, 0.480442770283 ]
  98% conf interval: [ 0.442385779606, 0.483698304489 ]
  99% conf interval: [ 0.440181391432, 0.485902692663 ]
  ** Operations List **
  Original vector : WLAN_QOS_NEW-EDCF_DEFAULT_VALUES-DES-1: Office Network.node_0.WLAN (Per HCF
Access Category).Media Access Delay (sec) <Voice>.none
  Operation #1
  Operation type  : Filter
  Filter name     : time_average
```